



Inverter

Inverter i510 Cabinet 0.25 ... 2.2 kW

This page intentionally left blank!

Contents

1	General information	8
1.1	Read first, then start.....	8
2	Safety instructions	9
2.1	Basic safety measures.....	9
3	Mounting	10
3.1	Mechanical installation.....	10
4	Commissioning	13
4.1	Before initial switch-on.....	13
4.2	Operator-process interfaces.....	14
4.3	Establishing the connection between the inverter and »EASY Starter«.....	15
4.4	Parameter setting.....	16
4.4.1	General notes on parameters.....	17
4.4.2	Basic inverter settings.....	18
4.4.3	Basic motor settings.....	20
4.4.4	Function assignment of the inputs and outputs.....	21
4.5	Keypad parameter list.....	24
5	Diagnostics and fault elimination	42
5.1	LED status displays.....	42
5.2	Keypad fault display.....	43
5.3	Diagnostics.....	44
5.3.1	Logbook.....	45
5.3.2	Error history buffer.....	46
5.3.3	Inverter diagnostics.....	48
5.3.4	Network diagnostics.....	53
5.3.4.1	CANopen diagnostics.....	54
5.3.4.2	Modbus diagnostics.....	57
5.3.5	Diagnostics of the inputs and outputs.....	57
5.3.5.1	Digital inputs and outputs.....	57
5.3.5.2	Analog inputs and outputs.....	58
5.3.6	Process controller status.....	60
5.3.7	Device identification.....	60
5.3.8	Device overload monitoring (i*t).....	61
5.3.9	Heatsink Temperature Monitoring.....	62
5.3.10	Diagnostics timer.....	62
5.4	Short overview of all error codes.....	63
6	Basic setting	66
6.1	Mains voltage.....	67
6.2	Control source selection.....	69
6.3	Selection of setpoint source.....	70
6.3.1	Keypad setpoint default setting.....	71
6.4	Starting/stopping performance.....	72
6.4.1	Starting performance.....	72
6.4.2	Stopping performance.....	72
6.5	Frequency limits and ramp times.....	73
6.6	Quick stop.....	74
6.7	S-shaped ramps.....	75
6.8	Optical device identification.....	76

Contents

7	Motor control	77
7.1	Motor data	78
7.2	Motor control selection	81
7.2.1	V/f characteristic control	81
7.2.1.1	Linear V/f characteristic.....	82
7.2.1.2	Square-law V/f characteristic.....	82
7.2.2	Sensorless vector control (SLVC).....	82
7.3	Optimisation of motor control	84
7.3.1	Voltage boost	84
7.3.2	Skip frequencies	84
7.3.3	Optimising the stalling behaviour	86
7.3.4	Slip compensation	87
7.3.5	Oscillation damping.....	88
7.4	Optimisation of the control loops.....	89
7.4.1	Speed controller	89
7.4.2	I _{max} controller	89
7.4.3	Current controller.....	89
7.5	Motor rotating direction.....	90
7.6	Switching frequency changeover.....	91
7.7	Motor protection.....	92
7.7.1	Motor overload monitoring (i ² *t)	92
7.7.2	Current limits.....	93
7.7.3	Ultimate motor current	94
7.7.4	Motor phase failure detection.....	94
7.7.5	Motor speed monitoring	95

8	Configuring the network	96
8.1	General network settings	97
8.2	Predefined process data words	104
8.2.1	Device profile CiA402	105
8.2.2	AC Drive Profile	106
8.2.3	Lenze LECOM profile	107
8.2.4	Further process data	108
8.3	Acyclic data exchange	111
8.4	CANopen	112
8.4.1	CANopen introduction	112
8.4.2	CANopen node address	112
8.4.3	CANopen baud rate	113
8.4.4	CANopen initialisation	113
8.4.5	CANopen diagnostics	114
8.4.6	CANopen emergency telegram	115
8.4.7	CANopen heartbeat protocol	115
8.4.8	CANopen process data objects	117
8.4.9	CANopen data mapping	120
8.4.10	CANopen service data objects	122
8.4.11	CANopen error responses	124
8.4.12	CANopen diagnostic counter	125
8.4.13	CANopen LED status displays	126
8.4.14	Resetting the CANopen interface	126
8.5	Modbus	127
8.5.1	Modbus introduction	127
8.5.2	Modbus node address	127
8.5.3	Modbus baud rate	128
8.5.4	Modbus data format	128
8.5.5	Modbus time-out monitoring	128
8.5.6	Modbus diagnostics	128
8.5.7	Modbus function codes	131
8.5.8	Modbus data mapping	132
8.5.9	Modbus LED status displays	136
8.5.10	Reset Modbus interface	136
8.5.11	Modbus response time	136
8.5.12	Short setup of Modbus	137
9	Configuring the process controller	138
9.1	Basic process controller settings	139
9.2	Process controller - idle state and rinse function	142
9.2.1	Process controller idle state	142
9.2.2	Process controller rinse function	143

Contents

10 Additional functions	144
10.1 Device Commands	145
10.1.1 Restoring the Lenze settings	145
10.1.2 Saving/loading the parameter settings	146
10.1.3 Device commands for parameter change-over	148
10.1.4 Initialising the network interface	149
10.1.5 Updating the memory module data format	149
10.1.6 Delete logbook	150
10.2 Keypad	151
10.2.1 Keypad language Selection	151
10.2.2 Keypad setpoint increment	151
10.2.3 Keypad scaling of speed display	151
10.2.4 Keypad status display	152
10.3 DC braking	153
10.4 Brake energy management	155
10.4.1 Stopping the deceleration ramp function generator	156
10.4.2 Inverter motor brake	157
10.5 Load loss detection	158
10.6 Access protection	159
10.6.1 Write access protection	160
10.7 Favorites	162
10.7.1 Accessing the "Favorites" with the keypad	162
10.7.2 Favorites parameter list (default setting)	162
10.7.3 Configuring the "Favorites"	163
10.8 Parameter change-over	167
10.9 Device profile CiA402	177
10.10 Holding brake control	180
10.11 Flying restart function	182
10.12 Fault configuration	183
10.13 Parameter for engineering tools	184

11 Flexible I/O configuration	186
11.1 Control source change-over	187
11.2 Controller enable, starting & stopping, reversal	188
11.3 Setpoint change-over	193
11.3.1 Priority of the setpoint sources	193
11.3.2 Analog input setpoint source	193
11.3.3 Keypad setpoint source	194
11.3.4 Network setpoint source	194
11.3.5 Setpoint source of preset setpoints	195
11.3.6 Motor potentiometer setpoint source	198
11.4 Reset error	201
11.5 Activating DC braking manually	202
11.6 Releasing holding brake manually	203
11.7 Activating ramp 2 manually	204
11.8 Triggering a user-defined fault	205
11.9 Functions for parameter change-over	206
11.10 Process controller function selection	207
11.11 Frequency threshold for "Frequency threshold exceeded" trigger	209
11.12 Configuration of digital inputs	210
11.13 Configuration of analog inputs	211
11.13.1 Analog input 1	211
11.13.2 Analog input 2	213
11.14 Configuration of digital outputs	215
11.14.1 Relay	215
11.14.2 Digital output 1	218
11.14.3 NETWordOUT1 status word	218
11.15 Configuration of analog outputs	221
11.15.1 Analog output 1	221
12 Technical data	223
12.1 Standards and operating conditions	223
12.2 Rated data	225
12.2.1 Connection to the 230 V system	225
12.2.2 Connection to the 400 V system	225
13 Appendix	226
13.1 Changing the parameter settings using the keypad	226
13.2 Parameter attribute list	229

General information

Read first, then start



1 General information

1.1 Read first, then start

WARNING!

Read this documentation thoroughly before carrying out the installation and commissioning.

► Please observe the safety instructions!



Information and tools with regard to the Lenze products can be found on the Internet:

<http://www.lenze.com> → Download



2 Safety instructions

2.1 Basic safety measures

Please observe the specific notes in the other chapters!

Notes used:

DANGER!

This note refers to an imminent danger which, if not avoided, may result in death or serious injury.

WARNING!

This note refers to a danger which, if not avoided, may result in death or serious injury.

CAUTION!

This note refers to a danger which, if not avoided, may result in minor or moderate injury.

NOTICE!

This note refers to a danger which, if not avoided, may result in damage to property.

Mounting

Mechanical installation



3 Mounting

3.1 Mechanical installation

Dimensions I51AE 0.25 kW ... 0.37 kW

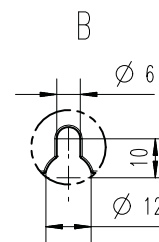
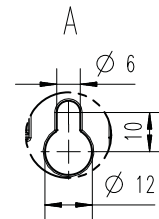
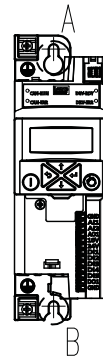
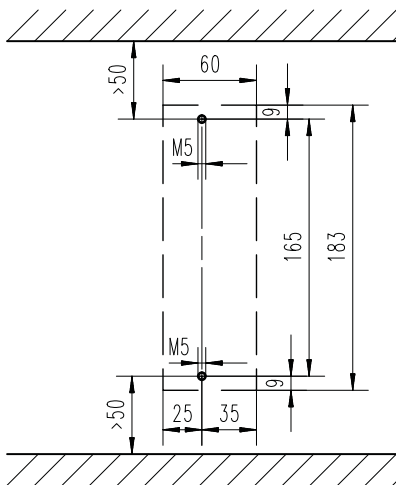
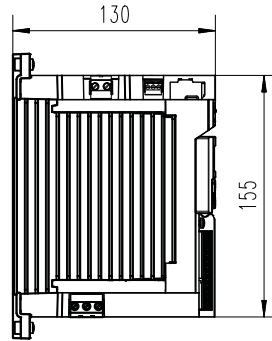
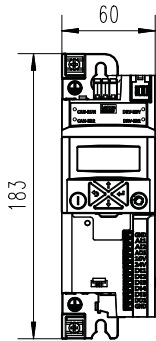

8800270

All dimensions in mm



Mounting

Mechanical installation

Dimensions I51AE 0.55 kW ... 0.75 kW

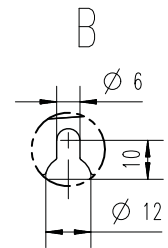
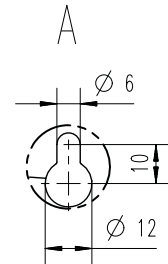
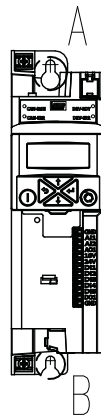
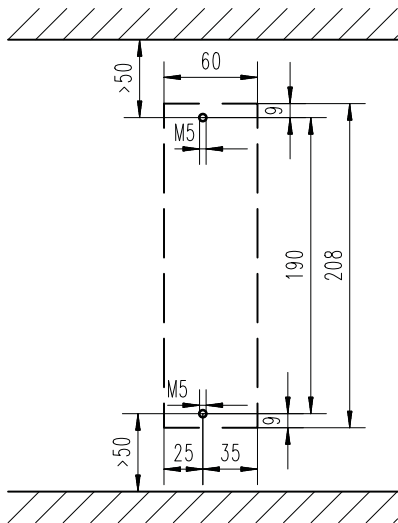
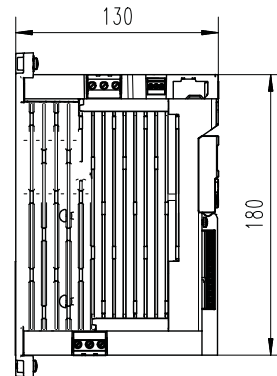
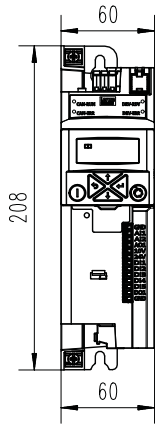

8800271

All dimensions in mm

Mounting

Mechanical installation



Dimensions I51AE 1.1 kW ... 2.2 kW

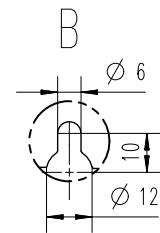
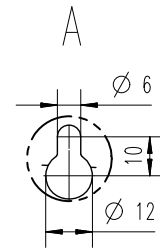
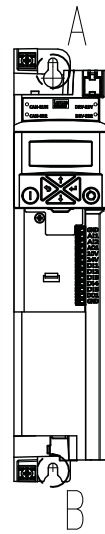
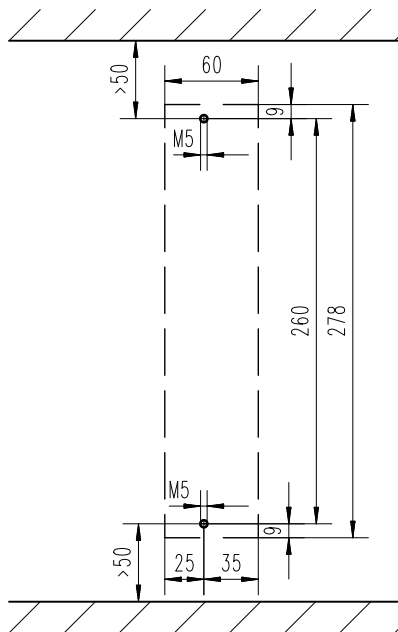
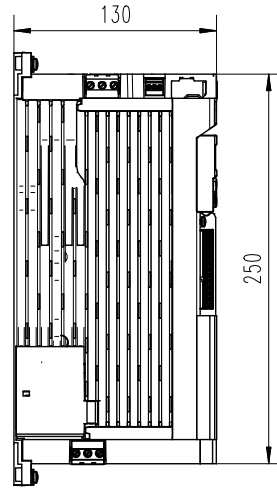
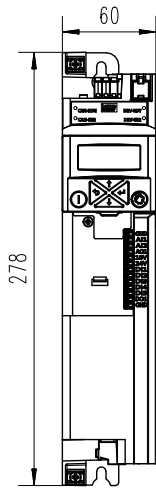

8800272

All dimensions in mm



4 Commissioning

4.1 Before initial switch-on

Prevent injury to persons and damage to property. Check the following before switching on the mains voltage:

- Is the wiring complete and correct?
- Are there no short circuits and earth faults?
- Is the motor circuit configuration (star/delta) adapted to the output voltage of the inverter?
- Is the motor connected in-phase (direction of rotation)?
- Does the "emergency stop" function of the entire plant operate correctly?



4.2 Operator-process interfaces

Commissioning the inverter requires an operator-process interface.

Keypad

The keypad is an easy means for the local operation, parameterisation, and diagnostics of the inverter.



- The keypad is simply connected to the diagnostic interface on the front of the inverter.
- The keypad can also be connected and removed during operation.
- Detailed information about the parameterisation by means of the keypad can be found in the "[Changing the parameter settings using the keypad](#)" chapter. [□ 226](#)

Lenze engineering tool »EASY Starter«

»EASY Starter« is a PC software that is specially designed for the commissioning and maintenance of Lenze devices.

Sample screenshot:

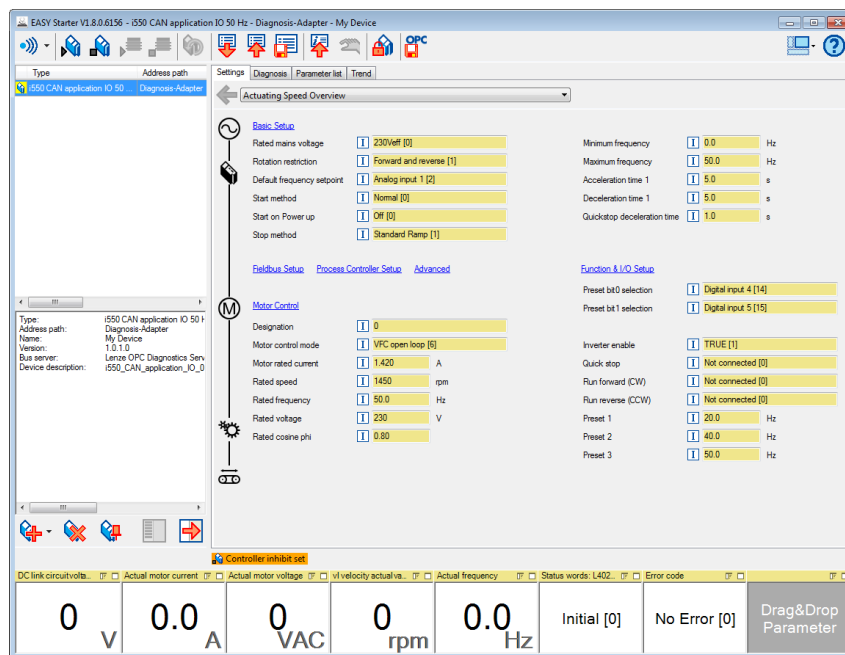

- Communication with the inverter requires the USB module and a USB 2.0 cable (A-plug on micro B-plug).



4.3 Establishing the connection between the inverter and »EASY Starter«



The »EASY Starter« PC software can be found on the Internet:
<http://www.lenze.com> → Download → Software Downloads.

Carry out the following steps if the inverter is to be commissioned using »EASY Starter«.

Requirements:

- The functional test described in the mounting and switch-on instructions has been completed successfully (without any errors or faults).
- The inverter is ready for operation (mains voltage is switched on).

Accessories required for commissioning:

- USB module
- USB 2.0 cable (A-plug on micro B-plug)
- PC with installed »EASY Starter« software

1. Connect USB module to interface X16 on the front of the inverter.
2. Use a USB cable to connect the inverter to the PC on which »EASY Starter« is installed:
 - a) Plug the micro B plug of the USB cable into the socket of the USB module.
 - b) Plug the other end into a free USB type A-socket of the PC.

3. Start »EASY Starter«.

The "Add devices" dialog is shown.

4. Select the "USB - diagnostics via IOMAXDU00000S adapter" connection:

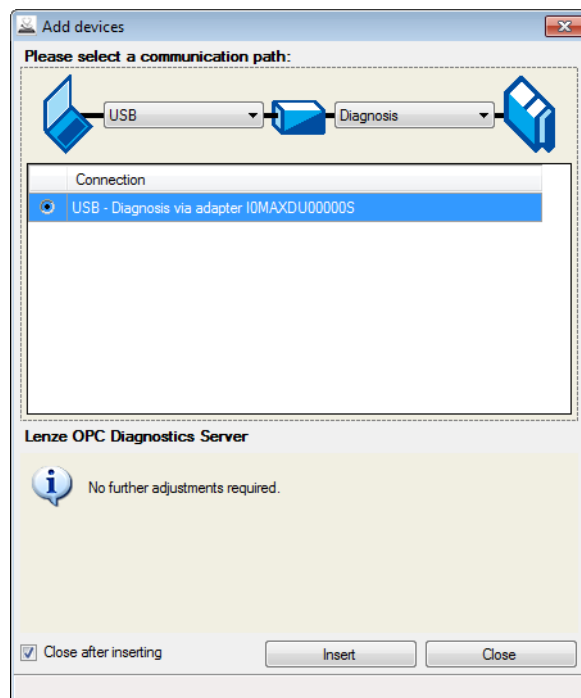

5. Click the **Insert** button.

»EASY Starter« searches for connected devices via the communication path selected. When the connection has been established successfully, the inverter is shown in the device list of »EASY Starter«. The inverter parameters can now be accessed via the tabs of »EASY Starter«.

Commissioning

Parameter setting



4.4 Parameter setting

As a part of a machine with a speed-variable drive system, the inverter must be adapted to its drive task. The adaptation process of the inverter is carried out by changing parameters. Optionally these parameters can be accessed by means of the keypad or »EASY Starter«. If the inverter is provided with a network option, access can also be effected by a higher-level control via the corresponding network.

DANGER!

Changed parameter settings are effective immediately.

The possible consequence is an unexpected response of the motor shaft while the inverter is enabled.

- ▶ If possible, only carry out parameter changes while the controller is inhibited.
 - ▶ Certain device commands or settings which might cause a critical state of the drive behaviour can generally only be carried out with controller inhibit.
-



4.4.1 General notes on parameters

Each parameter features a 16-bit index as address. Under this address, the parameter is stored in the object directory of the inverter.

- Parameters that belong together functionally are combined in a data set. These parameters are additionally provided with an 8-bit subindex.
- In the documentation the colon is used as a separator between the index and subindex. Example: "0x2540:001"
- There are parameters the setting of which can be changed, and (diagnostic) parameters which can only be read.

Parameterisation using the keypad

- All parameters which can be accessed by means of the keypad are provided with a "Display code", the first digit of the display code specifying the group in which the parameter can be found on the keypad.
- In the documentation, the display code — if available — is specified in brackets behind the address. Example: "0x2915 (PAR 210)".
- Parameters belonging together functionally and being provided with a subindex on the keypad are shown in the SUB parameter level. In the documentation, the diagonal slash "/" is used as a separator between the display code (PAR) and the subindex (SUB). Example: "PAR 208/001"

Structure of the parameter descriptions in this documentation

- The parameter descriptions in this documentation are structured in table form.
- The representation distinguishes parameters with a setting range, text, selection list, and bit-coded display.
- The default setting of parameters with a write access feature is shown in **bold**.
- The display code as well as the abbreviated keypad designation of the parameter, which is limited to 16 characters, are shown in *italics*.

Example: parameters with a setting range

Parameter	Name / value range / [default setting]	Info
Index:Subindex <i>(display code)</i>	Parameter designation <i>(abbreviated keypad designation)</i> Minimum value ... [default setting] ... maximum value • Optional information with regard to the parameter.	Explanations & notes with regard to the parameter.

Example: parameters with a selection list

Parameter	Name / value range / [default setting]	Info
Index:Subindex <i>(display code)</i>	Parameter designation <i>(abbreviated keypad designation)</i> • Optional information with regard to the parameter.	Explanations & notes with regard to the parameter. Note: The corresponding selection number (here 0, 1, or 2) must be set. Other values are not permissible.
	0 Designation of selection 0	Optionally: Explanations & notes with regard to the corresponding selection.
	1 Designation of selection 1	
	2 Designation of selection 2	The default selection is shown in bold .

Example: parameters with a bit-coded display

Parameter	Name / value range / [default setting]	Info
Index:Subindex <i>(display code)</i>	Parameter designation <i>(abbreviated keypad designation)</i> • Optional information with regard to the parameter.	Explanations & notes with regard to the parameter.
	Bit 0 Designation of bit 0	Optionally: Explanations & notes with regard to the corresponding bit.
	Bit 1 Designation of bit 1	
	Bit 2 Designation of bit 2	
	
	Bit 15 Designation of bit 15	

Commissioning

Parameter setting
Basic inverter settings



Parameter overview lists in this documentation

- [Keypad parameter list](#): for the parameterisation using the keypad, contains a list of all parameters which can also be accessed by means of the keypad. [□ 24](#)
- [Parameter attribute list](#): contains a list of all inverter parameters. This list in particular includes some information that is relevant for the reading and writing of parameters via the network. [□ 229](#)

4.4.2 Basic inverter settings

Check the following basic settings of the inverter and adapt them, if required.

Parameter	Name / value range / [default setting]	Info
0x2540:001 (PAR 208/001)	Mains voltage: Rated mains voltage (Mains volt. sett.: AC input volt.) • Setting can only be changed if controller inhibit is active.	Selection of the mains voltage for actuating the inverter.
	0 230 Veff	
	1 400 Veff	
	2 480 Veff	
0x2838:001 (PAR 203/001)	Start/stop configuration: Start method (Start/stop cfg: Start method) • Setting can only be changed if controller inhibit is active.	Starting performance of the inverter.
	0 Normal	After switch-on, the standard ramps are active. • Acceleration time 1 can be set in 0x2917 (PAR 220) . • Deceleration time 1 can be set in 0x2918 (PAR 221) .
	1 Start with DC braking	After switch-on, the "DC braking" function is active for the time set in 0x2B84:002 (PAR 704/002) . ▶ DC braking □ 153
	2 Flying Start	After switch-on, the "Restart on the fly" function is active. This function makes it possible to restart a coasting motor on the fly during operation without speed feedback. Synchronicity between the inverter and the motor is coordinated so that the transition to the rotating drive is effected without jerk at the time of connection. ▶ Flying restart function □ 182
0x2838:002 (PAR 203/002)	Start/stop configuration: Start at switch-on (Start/stop cfg: Start at switch-on)	Behaviour after mains connection.
	0 Off	If the controller is enabled at mains power-up, the inverter remains in the "Ready to switch on" state. For a change-over to the "Switched on" state, controller enable must be deactivated first. Only with the following controller enable, a change-over to the "Operation enabled" state is effected, and the motor follows the setpoint specified.
	1 On	If the controller is enabled at mains power-up, after mains power-up the motor directly follows the setpoint specified. With this setting, the inverter directly changes from the "Ready to switch on" state to the "Switched on" state and then to the "Operation enabled" state.
0x2838:003 (PAR 203/003)	Start/stop configuration: Stop method (Start/stop cfg: Stop method)	Behaviour after the "Stop" command.
	0 Coasting	The motor coasts down to standstill.
	1 Standard Ramp	The motor is brought to a standstill with deceleration time 1 (or deceleration time 2, if activated). • Deceleration time 1 can be set in 0x2918 (PAR 221) . • Deceleration time 2 can be set in 0x291A (PAR 223) . ▶ Frequency limits and ramp times □ 73
	2 Quick stop ramp	The motor is brought to a standstill with the deceleration time set for the "Quick stop" function. • Deceleration time for quick stop can be set in 0x291C (PAR 225) .



Commissioning

Parameter setting Basic inverter settings

Parameter	Name / value range / [default setting]	Info
0x283A (PAR 304)	Limitation of rotation (Rotation mode)	Optional restriction of the rotating direction.
	0 Only forwards	The motor can only be traversed in forward direction, since the transfer of negative frequency and process controller setpoints to the motor control is avoided. <ul style="list-style-type: none"> This function takes effect after the "Reversal" function (0x2631:013 (PAR 400/013)). Since this function only avoids negative setpoints, traversing in backward direction is possible if the motor has been wired for this rotating direction.
	1 Forwards and backwards	The motor can be traversed in both directions.
0x2860:001 (PAR 201/001)	Standard setpoint sources: Frequency setpoint source (Standard setpoint: Frequency setp.) <ul style="list-style-type: none"> For possible settings see description for 0x2860:001 (PAR 201/001). ☰ 70 	Selection of the standard setpoint source for speed mode. <ul style="list-style-type: none"> The standard setpoint source is always active in speed mode if no setpoint change-over to another setpoint source via corresponding triggers/functions is active. <ul style="list-style-type: none"> ▶ Setpoint change-over ☰ 193
	2 Analog input 1	The setpoint is specified analogously via X3/AI1. <ul style="list-style-type: none"> ▶ Analog input 1 ☰ 211
0x2911:001 (PAR 450/001)	Preset frequency values: Preset value 1 (Preset frequency values: Preset value 1) 0.0 ... [20.0] ... 599.0 Hz	Parameterisable frequency setpoints (preset values) for speed mode.
0x2911:002 (PAR 450/002)	Preset frequency values: Preset value 2 (Preset frequency values: Preset value 2) 0.0 ... [40.0] ... 599.0 Hz	
0x2911:003 (PAR 450/003)	Preset frequency values: Preset value 3 (Preset frequency values: Preset value 3) 0.0 ... [50.0] ... 599.0 Hz	
0x2915 (PAR 210)	Minimum frequency (Min. frequency) 0.0 ... [0.0] ... 599.0 Hz	Lower limit value for all frequency setpoints.
0x2916 (PAR 211)	Maximum frequency (Max. frequency) 0.0 ... [50.0] ... 599.0 Hz	Upper limit value for all frequency setpoints.
0x2917 (PAR 220)	Acceleration time 1 (Acceleration time 1) 0.0 ... [5.0] ... 3600.0 s	The acceleration time set refers to the acceleration from standstill to the maximum frequency set. In the case of a lower setpoint selection, the actual acceleration time is reduced accordingly.
0x2918 (PAR 221)	Deceleration time 1 (Deceleration time 1) 0.0 ... [5.0] ... 3600.0 s	The deceleration time set refers to the deceleration from the maximum frequency set to standstill. In the case of a lower actual frequency, the actual deceleration time is reduced accordingly.
0x291C (PAR 225)	Quick stop deceleration time (QSP dec. time) 0.0 ... [1.0] ... 3600.0 s	If the "Quick stop" function is activated, the motor is brought to a standstill within the deceleration time set here. The deceleration time set refers to the deceleration from the maximum frequency set to standstill. In the case of a lower actual frequency, the actual deceleration time is reduced accordingly.

All possible basic settings are described in the "Basic setting" chapter. [☰ 66](#)

Commissioning

Parameter setting
Basic motor settings



4.4.3 Basic motor settings

Check the following default settings for the motor and motor control and adapt them, if required.

Drive behaviour by default

By default, the V/f characteristic control with a linear characteristic is preset as motor control for asynchronous motors. The V/f characteristic control is a motor control for conventional frequency inverter applications. It is based on a simple and robust control mode for the operation of asynchronous motors with a linear or square-law load torque characteristic (e.g. fan). Because of the minimal parameterisation effort, such applications can be commissioned easily and quickly.

The default settings of the parameters ensure that the inverter is ready for operation immediately and the motor works adequately without further parameterisation if an inverter and a 50 Hz asynchronous machine with matching performances are assigned to each other.

Parameter	Name / value range / [default setting]	Info
0x2B01:001 (PAR 303/001)	V/f characteristic data: Base voltage (V/f char. data: Base voltage) 0 ... [230]* ... 5000 V • Default setting depending on the size.	Voltage in the reference point of the V/f characteristic. • The V/f base voltage is usually set to the rated motor voltage 0x2C01:007 (PAR 320/007) .
0x2B01:002 (PAR 303/002)	V/f characteristic data: Base frequency (V/f char. data: Base frequency) 0 ... [50]* ... 599 Hz • Default setting depending on the size.	Frequency in the reference point of the V/f characteristic. • The V/f base frequency is usually set to the rated motor frequency 0x2C01:005 (PAR 320/005) .
0x2C00 (PAR 300)	Motor control type (Motor ctrl mode) • Setting can only be changed if controller inhibit is active.	Selection of the motor control type.
	4 Sensorless vector control (SLVC)	This control type is used for sensorless vector control of an asynchronous motor. ▶ Sensorless vector control (SLVC) □ 82
	6 V/f characteristic control (VFC open loop)	This control mode is used for the speed control of an asynchronous motor via a V/f characteristic and is the simplest control mode. ▶ V/f characteristic control □ 81
0x2C01:010	Motor parameters: Name	
0x6075 (PAR 323)	Motor rated current (Motor current) 0.001 ... [1.700]* ... 500.000 A • Default setting depending on the size. • Setting can only be changed if controller inhibit is active.	The rated motor current to be set here serves as a reference value for different parameters with a setting/display in percent. Relevant parameters: • DC braking: Current 0x2B84:001 (PAR 704/001) • Flying restart circuit: Current 0x2BA1:001 (PAR 718/001) • Motor overload monitoring (i ² *t): Maximum utilisation [60 s] 0x2D4B:001 (PAR 308/001) • Max current 0x6073 (PAR 324) • Current actual value 0x6078 (PAR 103)

All possible settings with regard to the motor and motor control are described in the "[Motor control](#)" chapter. [□ 77](#)



4.4.4 Function assignment of the inputs and outputs

The inverter control can be adapted individually to the respective application. This is basically effected by assigning digital control sources ("triggers") to functions of the inverter.

By default, the inverter can be controlled via the I/O terminals as follows:

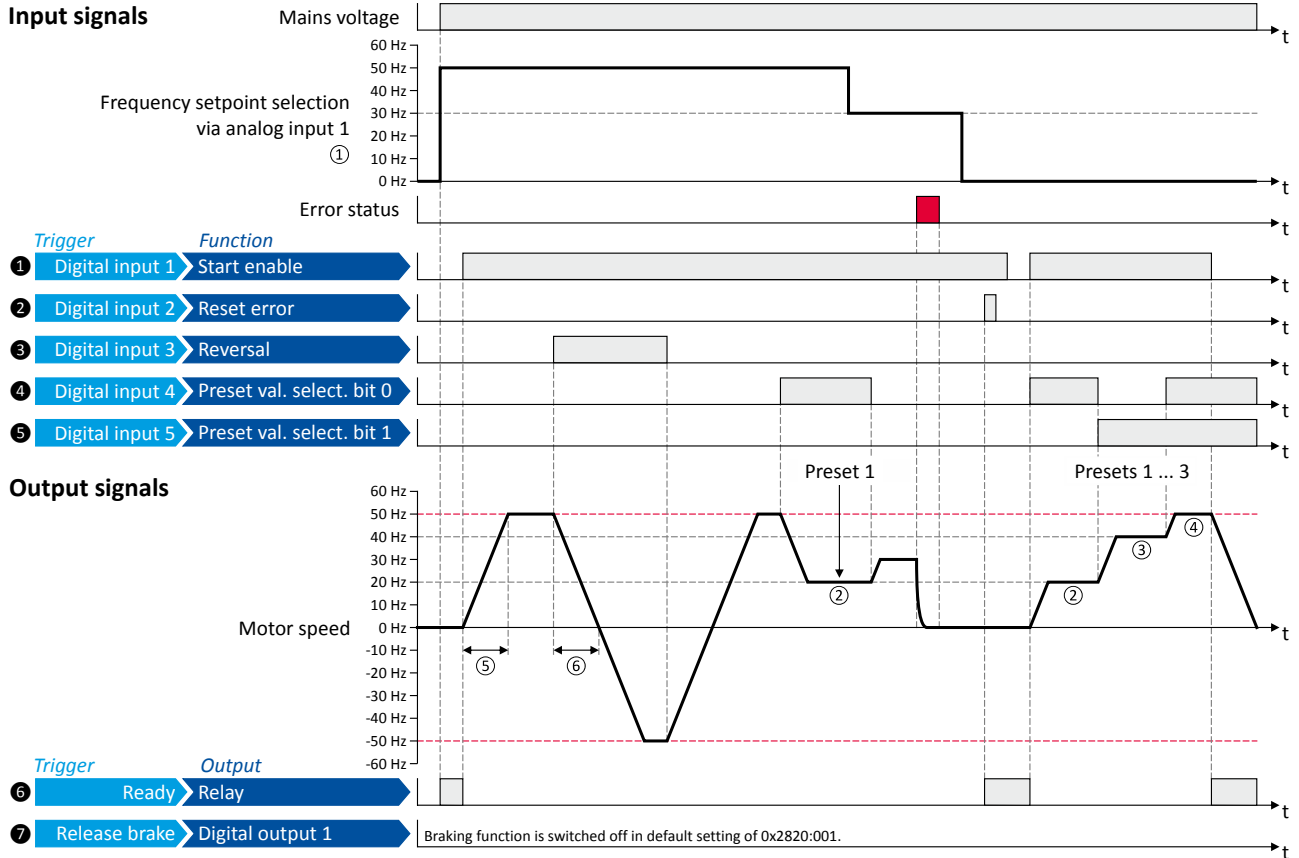

Parameter	Name	Lenze setting
① 0x2631:002 (PAR 400/002)	Start enable	11: digital input 1
② 0x2631:004 (PAR 400/004)	Reset error	12: digital input 2
③ 0x2631:013 (PAR 400/013)	Reversal	13: digital input 3
④ 0x2631:018 (PAR 400/018)	Preset val. selection bit 0	14: digital input 4
⑤ 0x2631:019 (PAR 400/019)	Preset val. selection bit 1	15: digital input 5
⑥ 0x2634:001 (PAR 420/001)	Relay	51: Ready for operation
⑦ 0x2634:002 (PAR 420/002)	Digital output 1	115: Release holding brake
① 0x2860:001 (PAR 201/001)	Frequency setpoint source	2: analog input 1
② 0x2911:001 (PAR 450/001)	Preset frequency values: Preset value 1	20 Hz
③ 0x2911:002 (PAR 450/002)	Preset frequency values: Preset value 2	40 Hz
④ 0x2911:003 (PAR 450/003)	Preset frequency values: Preset value 3	50 Hz
⑤ 0x2917 (PAR 220)	Acceleration time 1	5.0 s
⑥ 0x2918 (PAR 221)	Deceleration time 1	5.0 s

Commissioning

Parameter setting

Function assignment of the inputs and outputs



Parameter	Name / value range / [default setting]	Info
0x2631:002 (PAR 400/002)	Function assignment: Start enable (Function list: Start enable) <ul style="list-style-type: none"> Setting can only be changed if controller inhibit is active. For possible settings see description for 0x2631:001 (PAR 400/001). □ 188 	Assignment of a trigger for the "Start enable" function. Trigger = FALSE-TRUE edge: Drive is started in forward rotating direction (CW) if the following conditions are fulfilled: <ul style="list-style-type: none"> Controller is enabled and no error or quick stop are active. No other start command is configured (start-forwards/start-backwards/run-forwards/run-backwards = "Not connected [0]"). Trigger = TRUE-FALSE edge: drive is stopped again. Notes: <ul style="list-style-type: none"> If the controller enable is set = "Constant TRUE [1]", the only permissible trigger for this function is a digital input (otherwise the error message "Connected incorrectly" appears). The stop method can be selected in 0x2838:003 (PAR 203/003). The function also serves to realise an automatic start after switch-on. <ul style="list-style-type: none"> ▶ Starting performance □ 72
	11 Digital input 1	State of X3/DI1, taking an inversion set in 0x2632:001 (PAR 411/001) into consideration.
0x2631:003 (PAR 400/003)	Function assignment: Quick stop (Function list: Quick stop) <ul style="list-style-type: none"> Setting can only be changed if controller inhibit is active. For possible settings see description for 0x2631:001 (PAR 400/001). □ 188 	Assignment of a trigger for the "Quick stop" function. Trigger = TRUE: "Quick stop" function activated. Trigger = FALSE: no action / deactivate function again. Notes: <ul style="list-style-type: none"> The "Quick stop" function brings the motor to a standstill within the deceleration time set in 0x291C (PAR 225). The "Quick stop" function has a higher priority than the "Start enable" function.
	00 Not connected	No trigger assigned (trigger is constantly FALSE).
0x2631:004 (PAR 400/004)	Function assignment: Reset error (Function list: Reset error) <ul style="list-style-type: none"> For possible settings see description for 0x2631:001 (PAR 400/001). □ 188 	Assignment of a trigger for the "Reset error" function. Trigger = FALSE-TRUE edge: active error is reset (acknowledged) if the error cause has been eliminated. Trigger = FALSE: no action. Notes: <ul style="list-style-type: none"> After resetting the error, a new enable/start command is required to restart the drive.
	12 Digital input 2	State of X3/DI2, taking an inversion set in 0x2632:002 (PAR 411/002) into consideration.
0x2631:013 (PAR 400/013)	Function assignment: Reversal (Function list: Reversal of rot. dir.) <ul style="list-style-type: none"> Setting can only be changed if controller inhibit is active. For possible settings see description for 0x2631:001 (PAR 400/001). □ 188 	Assignment of a trigger for the "Reversal" function. Trigger = TRUE: the setpoint specified is inverted (i. e. the sign is inverted). Trigger = FALSE: no action / deactivate function again.
	13 Digital input 3	State of X3/DI3, taking an inversion set in 0x2632:003 (PAR 411/003) into consideration.
0x2631:018 (PAR 400/018)	Function assignment: Preset val. selection bit 0 (Function list: Preset b0) <ul style="list-style-type: none"> For possible settings see description for 0x2631:001 (PAR 400/001). □ 188 	Assignment of a trigger for the "Preset val. selection bit 0" function. Selection bit with the valency 20 for the bit-coded selection and activation of a parameterised setpoint (preset value). Trigger = FALSE: selection bit = "0". Trigger = TRUE: selection bit = "1".
	14 Digital input 4	State of X3/DI4, taking an inversion set in 0x2632:004 (PAR 411/004) into consideration.
0x2631:019 (PAR 400/019)	Function assignment: Preset val. selection bit 1 (Function list: Preset b1) <ul style="list-style-type: none"> For possible settings see description for 0x2631:001 (PAR 400/001). □ 188 	Assignment of a trigger for the "Preset val. selection bit 1" function. Selection bit with the valency 21 for the bit-coded selection and activation of a parameterised setpoint (preset value). Trigger = FALSE: selection bit = "0". Trigger = TRUE: selection bit = "1".
	15 Digital input 5	State of X3/DI5, taking an inversion set in 0x2632:005 (PAR 411/005) into consideration.



Commissioning

Parameter setting

Function assignment of the inputs and outputs

Parameter	Name / value range / [default setting]	Info
0x2634:001 (PAR 420/001)	Function assignment of digital outputs: Relay (Digital outputs: Relay function) • For possible settings see description for 0x2634:001 (PAR 420/001) . 186	Assignment of a trigger to the relay. Trigger = FALSE: X9/NO-COM open and NC-COM closed. Trigger = TRUE: X9/NO-COM closed and NC-COM open. Notes: • An inversion set in 0x2635:001 (PAR 421/001) is taken into consideration here.
	51 Ready for operation	TRUE if operation is enabled AND no error is active. Otherwise FALSE.
0x2634:002 (PAR 420/002)	Function assignment of digital outputs: Digital output 1 (Digital outputs: DO1 function) • For possible settings see description for 0x2634:001 (PAR 420/001) . 186	Assignment of a trigger to digital output 1. Trigger = FALSE: X3/DO1 set to LOW level. Trigger = TRUE: X3/DO1 set to HIGH level. Notes: • An inversion set in 0x2635:002 (PAR 421/002) is taken into consideration here.
	115 Release holding brake	TRUE if the holding brake is released (or should be released). Otherwise FALSE.

All functional possible settings for controlling the inverter are described in the "[Flexible I/O configuration](#)" chapter. [186](#)

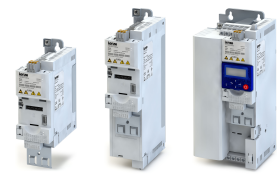

4.5 Keypad parameter list

For commissioning or diagnostics using the keypad, all parameters of the inverter that can also be accessed by means of the keypad are listed in the following "Keypad parameter list".

- The keypad parameter list is sorted in ascending order in compliance with the "Display code" (PAR xxx).
- In order to provide for quick access, all parameters of the inverter are divided into different groups according to their function.
- Group 0 contains the configurable "Favorites". In the default setting these are the most common parameters for the solution of typical applications. ▶ [Favorites](#) [162](#)
- By the hundreds digit of the PAR number (PAR Xxx) you can quickly see in which group the parameter is to be found on the keypad:

Group/name	Parameter	Description
Group 1 - Diagnostics	PAR 1xx	Diagnostic/display parameters for displaying device-internal process factors, current actual values, and status messages. ▶ Diagnostics 44
Group 2 - basic setting	PAR 2xx	Setting of the mains voltage, selection of the control and setpoint source, starting and stopping performance, frequency limits and ramp times. ▶ Basic setting 66
Group 3 - Motor Control	PAR 3xx	Configuration of the motor and motor control ▶ Motor control 77
Group 4 - I/O setting	PAR 4xx	Function assignment and configuration of the inputs and outputs ▶ Flexible I/O configuration 186
Group 5 - network setting	PAR 5xx	Configuration of the network (if available) ▶ Configuring the network 96
Group 6 - Process Controller	PAR 6xx	Configuration of the process controller ▶ Configuring the process controller 138
Group 7 - Additional Functions	PAR 7xx	Parameterisable additional functions ▶ Additional functions 144



A complete overview of all parameter indexes can be found in the annex in the [Parameter attribute list](#). [229](#)

How to read the keypad parameter list:

Column	Meaning
PAR	Parameter number on the keypad
Name / SUB xxx: name	Parameter name on the keypad For SUB parameters: subindex and name
Default setting	Default setting of the parameter
Setting range	Possible setting range for the parameter. Format: <i>minimum value ... maximum value [unit]</i>
Address	Address of the parameter in the object directory. Format: <i>index[:subindex]</i>

Keypad parameter list (short overview of all parameters with display code)

PAR	Name / SUB xxx: Name	Default setting	Setting range	Address
PAR 100	<i>Actual frequency</i>	x.x Hz	- (Read only)	0x2DDD
PAR 101	<i>Scaled actual value</i>	x Units	- (Read only)	0x400D
PAR 102	<i>Freq. setp. Hz</i>	x.x Hz	- (Read only)	0x2B0E
PAR 103	<i>Motor current %</i>	x.x %	- (Read only)	0x6078
PAR 104	<i>Act. motor current</i>	x.x A	- (Read only)	0x2D88
PAR 105	<i>DC bus</i>	x V	- (Read only)	0x2D87
PAR 106	<i>Motor voltage</i>	x VAC	- (Read only)	0x2D89
PAR 107	<i>Actual torque %</i>	x.x %	- (Read only)	0x6077

* Default setting depending on the size.

Firmware-Version 01.01.01.00



Commissioning

Keypad parameter list

PAR	Name / SUB xxx: Name	Default setting	Setting range	Address
PAR 108	<i>Output power</i>			
	SUB 001: <i>Effective power</i>	x.xxx kW	-(Read only)	0x2DA2:001
	SUB 002: <i>Apparent power</i>	x.xxx kW	-(Read only)	0x2DA2:002
PAR 109	<i>Output energy</i>			
	SUB 001: <i>Motor output energy</i>	x.xx kWh	-(Read only)	0x2DA3:001
	SUB 002: <i>Gen. output energy</i>	x.xx kWh	-(Read only)	0x2DA3:002
PAR 110	<i>AI1 diagnostics</i>			
	SUB 001: <i>AI1 terminal %</i>	x.x %	-(Read only)	0x2DA4:001
	SUB 002: <i>AI1 scaled freq.</i>	x.x Hz	-(Read only)	0x2DA4:002
	SUB 003: <i>AI1 scaled PID</i>	x.xx PUnit	-(Read only)	0x2DA4:003
	SUB 004: <i>AI1 scaled torque</i>	x.xx %	-(Read only)	0x2DA4:004
	SUB 016: <i>AI1 status</i>	-	-(Read only)	0x2DA4:016
PAR 111	<i>AI2 diagnostics</i>			
	SUB 001: <i>AI2 terminal %</i>	x.x %	-(Read only)	0x2DA5:001
	SUB 002: <i>AI2 scaled freq.</i>	x.x Hz	-(Read only)	0x2DA5:002
	SUB 003: <i>AI2 scaled PID</i>	x.xx PUnit	-(Read only)	0x2DA5:003
	SUB 004: <i>AI2 scaled torque</i>	x.xx %	-(Read only)	0x2DA5:004
	SUB 016: <i>AI2 status</i>	-	-(Read only)	0x2DA5:016
PAR 112	<i>AO1 value</i>			
	SUB 001: <i>Analog outp.1 volt.</i>	x.xx V	-(Read only)	0x2DAA:001
	SUB 002: <i>Analog outp.1 current</i>	x.xx mA	-(Read only)	0x2DAA:002
PAR 117	<i>Heatsink temp.</i>			
	SUB 001: <i>Heatsink temp.</i>	x.x °C	-(Read only)	0x2D84:001
PAR 118	<i>Dig.inp. status</i>	-	-(Read only)	0x60FD
PAR 119	<i>Keypad status</i>	-	-(Read only)	0x2DAC
PAR 120	<i>Int. HW states</i>	-	-(Read only)	0x2DAD
PAR 121	<i>PID diagnostics</i>			
	SUB 001: <i>Curr. PID setp.</i>	x.xx PUnit	-(Read only)	0x401F:001
	SUB 002: <i>Curr. PID feedb.</i>	x.xx PUnit	-(Read only)	0x401F:002
	SUB 003: <i>PID status</i>	-	-(Read only)	0x401F:003
PAR 123	<i>Mot. I2t utilis.</i>	x %	-(Read only)	0x2D4F
PAR 125	<i>Inverter diag.</i>			
	SUB 001: <i>Active ctrl</i>	-	-(Read only)	0x282B:001
	SUB 002: <i>Active setpoint</i>	-	-(Read only)	0x282B:002
	SUB 003: <i>LCD icon status</i>	-	-(Read only)	0x282B:003
	SUB 004: <i>Drive mode</i>	-	-(Read only)	0x282B:004
	SUB 005: <i>Netw. contr.reg.</i>	-	-(Read only)	0x282B:005
	SUB 006: <i>Netw. setp.reg.</i>	-	-(Read only)	0x282B:006
PAR 126	<i>Status words</i>			
	SUB 001: <i>Cause of contr. inhibit</i>	-	-(Read only)	0x282A:001
	SUB 002: <i>Cause of QSP</i>	-	-(Read only)	0x282A:002
	SUB 003: <i>Cause of stop</i>	-	-(Read only)	0x282A:003
	SUB 005: <i>Device status</i>	-	-(Read only)	0x282A:005
PAR 135	<i>Device utilisation</i>			
	SUB 004: <i>Ixt utilisation</i>	x %	-(Read only)	0x2D40:004
	SUB 005: <i>Error response</i>	Error [3]	<i>Selection list</i>	0x2D40:005
PAR 150	<i>Active error</i>	-	-(Read only)	0x603F
PAR 151	<i>Timer/counter</i>			
	SUB 001: <i>Operating time</i>	x s	-(Read only)	0x2D81:001
	SUB 002: <i>Operating time</i>	x s	-(Read only)	0x2D81:002
	SUB 003: <i>CU oper. time</i>	x ns	-(Read only)	0x2D81:003
* Default setting depending on the size.				Firmware-Version 01.01.01.00

Commissioning

Keypad parameter list



PAR	Name / SUB xxx: Name	Default setting	Setting range	Address
	SUB 004: Power cycles	-	-(Read only)	0x2D81:004
	SUB 005: Relay cycles	-	-(Read only)	0x2D81:005
	SUB 006: Short-circ. counter	-	-(Read only)	0x2D81:006
	SUB 007: Earth fault counter	-	-(Read only)	0x2D81:007
	SUB 008: Clamp active	-	-(Read only)	0x2D81:008
	SUB 009: Fan oper. time	x s	-(Read only)	0x2D81:009
PAR 155	Fault memory			
	SUB 000: Keypad display	-	-(Read only)	0x2006:000
PAR 190	Product information			
	SUB 001: Product code	-	-(Read only)	0x2000:001
	SUB 002: Serial number	-	-(Read only)	0x2000:002
	SUB 004: CU firmware ver.	-	-(Read only)	0x2000:004
	SUB 005: CU firmware type	-	-(Read only)	0x2000:005
	SUB 006: CU bootldr ver.	-	-(Read only)	0x2000:006
	SUB 007: CU bootldr type	-	-(Read only)	0x2000:007
	SUB 008: OBD version	-	-(Read only)	0x2000:008
	SUB 010: PU firmware ver.	-	-(Read only)	0x2000:010
	SUB 011: PU firmware type	-	-(Read only)	0x2000:011
	SUB 012: PU bootldr ver.	-	-(Read only)	0x2000:012
	SUB 013: PU bootldr type	-	-(Read only)	0x2000:013
PAR 191	Device name	My Device	Text	0x2001
PAR 197	Protection status	-	-(Read only)	0x2040
PAR 198	Status of load. par	-	-(Read only)	0x2827
PAR 200	Control source	Terminal mode [0]	Selection list	0x2824
PAR 201	Standard setpoint			
	SUB 001: Frequency setp.	Analog input 1 [2]	Selection list	0x2860:001
	SUB 002: PID setpoint	Keyp.PID.setp. [1]	Selection list	0x2860:002
	SUB 003: Torque setp.	Analog input 1 [2]	Selection list	0x2860:003
PAR 202	Keypad setpoints			
	SUB 001: KP freq. setp.	20.0 Hz	0.0 ... 599.0 Hz	0x2601:001
	SUB 002: KP PID setp.	0.00 PUnit	-300.00 ... 300.00 PUnit	0x2601:002
PAR 203	Start/stop config			
	SUB 001: Start method	Normal [0]	Selection list	0x2838:001
	SUB 002: Start at switch-on	OFF [0]	Selection list	0x2838:002
	SUB 003: Stop method	Standard Ramp [1]	Selection list	0x2838:003
PAR 208	Mains volt. sett.			
	SUB 001: AC input volt.	230 Veff [0]	Selection list	0x2540:001
	SUB 002: LU warning level	0 V *	0 ... 800 V	0x2540:002
	SUB 003: LU error level	x V	-(Read only)	0x2540:003
	SUB 004: LU deletion level	x V	-(Read only)	0x2540:004
	SUB 005: OU warning level	0 V *	0 ... 800 V	0x2540:005
	SUB 006: OU error level	x V	-(Read only)	0x2540:006
	SUB 007: OU deletion level	x V	-(Read only)	0x2540:007
PAR 210	Min. frequency	0.0 Hz	0.0 ... 599.0 Hz	0x2915
PAR 211	Max. frequency	50.0 Hz	0.0 ... 599.0 Hz	0x2916
PAR 220	Acceleration time 1	5.0 s	0.0 ... 3600.0 s	0x2917
PAR 221	Deceleration time 1	5.0 s	0.0 ... 3600.0 s	0x2918
PAR 222	Acceleration time 2	5.0 s	0.0 ... 3600.0 s	0x2919
PAR 223	Deceleration time 2	5.0 s	0.0 ... 3600.0 s	0x291A
PAR 224	Switch ramp	0.0 Hz	0.0 ... 599.0 Hz	0x291B
PAR 225	QSP dec. time	1.0 s	0.0 ... 3600.0 s	0x291C
PAR 226	S-ramp char.			
	SUB 001: S-Ramp smoothing	0.0 %	0.0 ... 100.0 %	0x291E:001

* Default setting depending on the size.

Firmware-Version 01.01.01.00



Commissioning

Keypad parameter list

PAR	Name / SUB xxx: Name	Default setting	Setting range	Address
PAR 230	<i>Opt.dev.det.</i>			
	SUB 001: <i>Opt.det: start</i>	Stop [0]	Selection list	0x2021:001
	SUB 002: <i>Opt.det: time</i>	5 s	0 ... 3600 s	0x2021:002
PAR 300	<i>Motor ctrl mode</i>	VFC open loop [6]	Selection list	0x2C00
PAR 301	<i>Modes of op.</i>	L-speed mode [-2]	Selection list	0x6060
PAR 302	<i>V/f curve</i>	Linear [0]	Selection list	0x2B00
PAR 303	<i>V/f char. data</i>			
	SUB 001: <i>Base voltage</i>	230 V *	0 ... 5000 V	0x2B01:001
	SUB 002: <i>Base frequency</i>	50 Hz *	0 ... 599 Hz	0x2B01:002
PAR 304	<i>Rotation mode</i>	Forwards/backw. [1]	Selection list	0x283A
PAR 305	<i>Switching frequency</i>	8kHz var/opt/4 [21]	Selection list	0x2939
PAR 308	<i>Motor overload</i>			
	SUB 001: <i>Load at 60 sec</i>	150 %	30 ... 200 %	0x2D4B:001
	SUB 002: <i>Speed comp.</i>	On [0]	Selection list	0x2D4B:002
	SUB 003: <i>Error response</i>	Error [3]	Selection list	0x2D4B:003
PAR 310	<i>Motor Ø failure</i>			
	SUB 001: <i>Ø error response</i>	No response [0]	Selection list	0x2D45:001
	SUB 002: <i>Ø error current</i>	5.0 %	1.0 ... 10.0 %	0x2D45:002
	SUB 003: <i>Ø error volt.</i>	10.0 V	0.0 ... 100.0 V	0x2D45:003
PAR 315	<i>Slip compens.</i>			
	SUB 001: <i>Slip: gain</i>	100.00 %	-200.00 ... 200.00 %	0x2B09:001
	SUB 002: <i>Filter time</i>	5 ms	1 ... 6000 ms	0x2B09:002
PAR 316	<i>V/f boosts</i>			
	SUB 001: <i>V/f boost: stat.</i>	2.5 % *	0.0 ... 20.0 %	0x2B12:001
	SUB 002: <i>V/f boost: dyn.</i>	0.0 %	0.0 ... 20.0 %	0x2B12:002
PAR 317	<i>Skip frequencies</i>			
	SUB 001: <i>Frequency 1</i>	0.0 Hz	0.0 ... 599.0 Hz	0x291F:001
	SUB 002: <i>Bandwidth 1</i>	0.0 Hz	0.0 ... 10.0 Hz	0x291F:002
	SUB 003: <i>Frequency 2</i>	0.0 Hz	0.0 ... 599.0 Hz	0x291F:003
	SUB 004: <i>Bandwidth 2</i>	0.0 Hz	0.0 ... 10.0 Hz	0x291F:004
	SUB 005: <i>Frequency 3</i>	0.0 Hz	0.0 ... 599.0 Hz	0x291F:005
	SUB 006: <i>Bandwidth 3</i>	0.0 Hz	0.0 ... 10.0 Hz	0x291F:006
PAR 318	<i>Oscillation damping</i>			
	SUB 001: <i>Oscillation: gain</i>	20 %	-100 ... 100 %	0x2B0A:001
	SUB 002: <i>Oscillation: time</i>	5 ms	1 ... 600 ms	0x2B0A:002
PAR 319	<i>Overr. point of field weak.</i>	0.0 Hz	-599.0 ... 599.0 Hz	0x2B0C
PAR 320	<i>Motor parameters</i>			
	SUB 004: <i>Mot. speed</i>	1450 rpm	50 ... 50000 rpm	0x2C01:004
	SUB 005: <i>Mot. frequency</i>	50.0 Hz	1.0 ... 1000.0 Hz	0x2C01:005
	SUB 006: <i>Motor power</i>	0.25 kW *	0.00 ... 655.35 kW	0x2C01:006
	SUB 007: <i>Motor voltage</i>	230 V *	0 ... 65535 V	0x2C01:007
	SUB 008: <i>Mot. cosine phi</i>	0.80	0.00 ... 1.00	0x2C01:008
PAR 322	<i>Max. motor speed</i>	6075 rpm	0 ... 480000 rpm	0x6080
PAR 323	<i>Motor current</i>	1.700 A *	0.001 ... 500.000 A	0x6075
PAR 324	<i>Max current</i>	200.0 %	0.0 ... 3000.0 %	0x6073
PAR 325	<i>Motor torque</i>	1.650 Nm *	0.001 ... 1000.000 Nm	0x6076
PAR 327	<i>Axis commands</i>			
	SUB 004: <i>Mot. ident.</i>	0	0 ... 1	0x2822:004
	SUB 005: <i>Motor assessment</i>	0	0 ... 1	0x2822:005
PAR 332	<i>Speed controller</i>			
	SUB 001: <i>Speed contr.: gain</i>	0.00193 Nm/rpm *	0.00000 ... 20000.00000 Nm/rpm	0x2900:001
	SUB 002: <i>Speed contr.: time</i>	80.0 ms *	1.0 ... 6000.0 ms	0x2900:002

* Default setting depending on the size.

Firmware-Version 01.01.01.00

Commissioning

Keypad parameter list



PAR	Name / SUB xxx: Name	Default setting	Setting range	Address
PAR 333	<i>V/f I_{max} controller</i>			
	SUB 001: <i>I_{max} ctrller: gain</i>	0.284 Hz/A *	0.000 ... 1000.000 Hz/A	0x2B08:001
	SUB 002: <i>I_{max} ctrller: time</i>	2.3 ms *	1.0 ... 2000.0 ms	0x2B08:002
PAR 334	<i>Current controller</i>			
	SUB 001: <i>I-contr.: gain</i>	42.55 V/A *	0.00 ... 750.00 V/A	0x2942:001
	SUB 002: <i>I-contr.: time</i>	4.50 ms *	0.01 ... 2000.00 ms	0x2942:002
PAR 335	<i>Moment of inertia</i>			
	SUB 001: <i>Motor inertia</i>	3.70 kg cm² *	0.00 ... 20000000.00 kg cm ²	0x2910:001
	SUB 002: <i>Load inertia</i>	3.70 kg cm² *	0.00 ... 20000000.00 kg cm ²	0x2910:002
PAR 350	<i>Overspeed monit.</i>			
	SUB 001: <i>Overspeed: threshold</i>	8000 rpm	50 ... 50000 rpm	0x2D44:001
	SUB 002: <i>Overspeed: response</i>	Error [3]	<i>Selection list</i>	0x2D44:002
PAR 351	<i>ASM motor par.</i>			
	SUB 001: <i>ASM rotor res.</i>	8.8944 Ohm *	0.0000 ... 200.0000 Ohm	0x2C02:001
	SUB 002: <i>ASM mutual ind.</i>	381.9 mH *	0.0 ... 50000.0 mH	0x2C02:002
	SUB 003: <i>ASM magn. current</i>	0.96 A *	0.00 ... 500.00 A	0x2C02:003
	SUB 004: <i>ASM slip freq.</i>	x.x Hz	- (Read only)	0x2C02:004
PAR 353	<i>Ult mot. current monit.</i>			
	SUB 001: <i>Mot. current threshold</i>	6.8 A *	0.0 ... 500.0 A	0x2D46:001
	SUB 002: <i>Mot. current resp.</i>	Error [3]	<i>Selection list</i>	0x2D46:002
PAR 400	<i>Function list</i>			
	SUB 001: <i>Controller enable</i>	TRUE [1]	<i>Selection list</i>	0x2631:001
	SUB 002: <i>Start enable</i>	Digital input 1 [11]	<i>Selection list</i>	0x2631:002
	SUB 003: <i>Quick stop</i>	Not connected [0]	<i>Selection list</i>	0x2631:003
	SUB 004: <i>Reset error</i>	Digital input 2 [12]	<i>Selection list</i>	0x2631:004
	SUB 005: <i>DC braking</i>	Not connected [0]	<i>Selection list</i>	0x2631:005
	SUB 006: <i>Forward start</i>	Not connected [0]	<i>Selection list</i>	0x2631:006
	SUB 007: <i>Backward start</i>	Not connected [0]	<i>Selection list</i>	0x2631:007
	SUB 008: <i>Forward run</i>	Not connected [0]	<i>Selection list</i>	0x2631:008
	SUB 009: <i>Backward run</i>	Not connected [0]	<i>Selection list</i>	0x2631:009
	SUB 010: <i>Forward jog</i>	Not connected [0]	<i>Selection list</i>	0x2631:010
	SUB 011: <i>Backward jog</i>	Not connected [0]	<i>Selection list</i>	0x2631:011
	SUB 012: <i>Keypad control</i>	Not connected [0]	<i>Selection list</i>	0x2631:012
	SUB 013: <i>Reversal of rot. dir.</i>	Digital input 3 [13]	<i>Selection list</i>	0x2631:013
	SUB 014: <i>Setpoint=AI1</i>	Not connected [0]	<i>Selection list</i>	0x2631:014
	SUB 015: <i>Setpoint=AI2</i>	Not connected [0]	<i>Selection list</i>	0x2631:015
	SUB 016: <i>Setpoint=Keypad</i>	Not connected [0]	<i>Selection list</i>	0x2631:016
	SUB 018: <i>Preset b0</i>	Digital input 4 [14]	<i>Selection list</i>	0x2631:018
	SUB 019: <i>Preset b1</i>	Digital input 5 [15]	<i>Selection list</i>	0x2631:019
	SUB 020: <i>Preset b2</i>	Not connected [0]	<i>Selection list</i>	0x2631:020
	SUB 021: <i>Preset b3</i>	Not connected [0]	<i>Selection list</i>	0x2631:021
	SUB 022: <i>Setp=Dig freq in</i>	Not connected [0]	<i>Selection list</i>	0x2631:022
	SUB 023: <i>MOP up</i>	Not connected [0]	<i>Selection list</i>	0x2631:023
	SUB 024: <i>MOP down</i>	Not connected [0]	<i>Selection list</i>	0x2631:024
	SUB 025: <i>Setpoint=MOP</i>	Not connected [0]	<i>Selection list</i>	0x2631:025
	SUB 037: <i>Network enable</i>	Not connected [0]	<i>Selection list</i>	0x2631:037
	SUB 039: <i>Activ. ramp 2</i>	Not connected [0]	<i>Selection list</i>	0x2631:039
	SUB 040: <i>Load param.set</i>	Not connected [0]	<i>Selection list</i>	0x2631:040
	SUB 041: <i>Par.set selection b0</i>	Not connected [0]	<i>Selection list</i>	0x2631:041
	SUB 042: <i>Par.set selection b1</i>	Not connected [0]	<i>Selection list</i>	0x2631:042
	SUB 043: <i>User-def fault 1</i>	Not connected [0]	<i>Selection list</i>	0x2631:043

* Default setting depending on the size.

Firmware-Version 01.01.01.00



Commissioning

Keypad parameter list

PAR	Name / SUB xxx: Name	Default setting	Setting range	Address
	SUB 044: User-def fault 2	Not connected [0]	Selection list	0x2631:044
	SUB 045: PID off	Not connected [0]	Selection list	0x2631:045
	SUB 046: PID output=0	Not connected [0]	Selection list	0x2631:046
	SUB 047: PID-I inhibited	Not connected [0]	Selection list	0x2631:047
	SUB 048: PID-Inf ramp on	TRUE [1]	Selection list	0x2631:048
	SUB 049: Release brake	Not connected [0]	Selection list	0x2631:049
PAR 410	<i>DigIn HW config.</i>			
	SUB 002: DigIn HW mode	Digital Input [0]	Selection list	0x2630:002
PAR 411	<i>DI inversion</i>			
	SUB 001: DI1 inversion	Not inverted [0]	Selection list	0x2632:001
	SUB 002: DI2 inversion	Not inverted [0]	Selection list	0x2632:002
	SUB 003: DI3 inversion	Not inverted [0]	Selection list	0x2632:003
	SUB 004: DI4 inversion	Not inverted [0]	Selection list	0x2632:004
	SUB 005: DI5 inversion	Not inverted [0]	Selection list	0x2632:005
PAR 412	Freq. threshold	0.0 Hz	0.0 ... 599.0 Hz	0x4005
PAR 413	MOP startmod	Last value [0]	Selection list	0x4003
PAR 414	<i>MOP starting value</i>			
	SUB 001: MOP starting freq	0.0 Hz	0.0 ... 599.0 Hz	0x4004:001
	SUB 002: MOP starting PID	0.00 PUnit	-300.00 ... 300.00 PUnit	0x4004:002
	SUB 003: MOP starting torque	0.0 %	0.0 ... 1000.0 %	0x4004:003
PAR 420	<i>Digital outputs</i>			
	SUB 001: Relay function	Ready for operation [51]	Selection list	0x2634:001
	SUB 002: DO1 function	Release brake [115]	Selection list	0x2634:002
	SUB 010: NETWordOUT1.00	Ready for operation [51]	Selection list	0x2634:010
	SUB 011: NETWordOUT1.01	Reversal of rot. dir. [69]	Selection list	0x2634:011
	SUB 012: NETWordOUT1.02	Running [50]	Selection list	0x2634:012
	SUB 013: NETWordOUT1.03	Error [56]	Selection list	0x2634:013
	SUB 014: NETWordOUT1.04	Safe Torque Off [55]	Selection list	0x2634:014
	SUB 015: NETWordOUT1.05	Quick stop [54]	Selection list	0x2634:015
	SUB 016: NETWordOUT1.06	Actual speed=0 [71]	Selection list	0x2634:016
	SUB 017: NETWordOUT1.07	Device warning [58]	Selection list	0x2634:017
	SUB 018: NETWordOUT1.08	Release brake [115]	Selection list	0x2634:018
	SUB 019: NETWordOUT1.09	Current limit reached [78]	Selection list	0x2634:019
	SUB 020: NETWordOUT1.10	Speed - setp=act [72]	Selection list	0x2634:020
	SUB 021: NETWordOUT1.11	Not connected [0]	Selection list	0x2634:021
	SUB 022: NETWordOUT1.12	Not connected [0]	Selection list	0x2634:022
	SUB 023: NETWordOUT1.13	Not connected [0]	Selection list	0x2634:023
	SUB 024: NETWordOUT1.14	Not connected [0]	Selection list	0x2634:024
	SUB 025: NETWordOUT1.15	Not connected [0]	Selection list	0x2634:025
PAR 421	<i>DO inversion</i>			
	SUB 001: Relay inverted	Not inverted [0]	Selection list	0x2635:001
	SUB 002: DO1 inversion	Not inverted [0]	Selection list	0x2635:002
PAR 430	<i>Analog input 1</i>			
	SUB 001: AI1 config.	0...10VDC [0]	Selection list	0x2636:001
	SUB 002: AI1 freq @ min	0.0 Hz	-1000.0 ... 1000.0 Hz	0x2636:002
	SUB 003: AI1 freq @ max	50.0 Hz	-1000.0 ... 1000.0 Hz	0x2636:003
	SUB 004: AI1 PID/Mom@min	0.00 PUnit/%	-300.00 ... 300.00 PUnit/%	0x2636:004
	SUB 005: AI1 PID/Mom@max	100.00 PUnit/%	-300.00 ... 300.00 PUnit/%	0x2636:005
	SUB 006: AI1 filter time	10 ms	0 ... 10000 ms	0x2636:006
	SUB 007: AI1 dead band	0.0 %	0.0 ... 100.0 %	0x2636:007
	SUB 008: AI1 monit.level	0.0 %	-100.0 ... 100.0 %	0x2636:008
	SUB 009: AI1 monit.action	Below level 1 [0]	Selection list	0x2636:009
	SUB 010: AI1 error resp.	Error [3]	Selection list	0x2636:010

* Default setting depending on the size.

Firmware-Version 01.01.01.00

Commissioning

Keypad parameter list



PAR	Name / SUB xxx: Name	Default setting	Setting range	Address
PAR 431	<i>Analog input 2</i>			
	SUB 001: AI2 config.	0...10VDC [0]	<i>Selection list</i>	0x2637:001
	SUB 002: AI2 freq @ min	0.0 Hz	-1000.0 ... 1000.0 Hz	0x2637:002
	SUB 003: AI2 freq @ max	50.0 Hz	-1000.0 ... 1000.0 Hz	0x2637:003
	SUB 004: AI2 PID/Mom@min	0.00 PUnit/%	-300.00 ... 300.00 PUnit/%	0x2637:004
	SUB 005: AI2 PID/Mom@max	100.00 PUnit/%	-300.00 ... 300.00 PUnit/%	0x2637:005
	SUB 006: AI2 filter time	10 ms	0 ... 10000 ms	0x2637:006
	SUB 007: AI2 dead band	0.0 %	0.0 ... 100.0 %	0x2637:007
	SUB 008: AI2 monit.level	0.0 %	-100.0 ... 100.0 %	0x2637:008
	SUB 009: AI2 monit.action	Below level 1 [0]	<i>Selection list</i>	0x2637:009
SUB 010: AI2 error resp.	Error [3]	<i>Selection list</i>	0x2637:010	
PAR 440	<i>Analog output 1</i>			
	SUB 001: AO1 config.	0...10VDC [1]	<i>Selection list</i>	0x2639:001
	SUB 002: AO1 function	Actual outp. freq. [1]	<i>Selection list</i>	0x2639:002
	SUB 003: AO1 funct @ min	0	-2147483648 ... 2147483647	0x2639:003
SUB 004: AO1 funct @ max	1000	-2147483648 ... 2147483647	0x2639:004	
PAR 450	<i>Preset frequency values</i>			
	SUB 001: Preset value 1	20.0 Hz	0.0 ... 599.0 Hz	0x2911:001
	SUB 002: Preset value 2	40.0 Hz	0.0 ... 599.0 Hz	0x2911:002
	SUB 003: Preset value 3	50.0 Hz	0.0 ... 599.0 Hz	0x2911:003
	SUB 004: Preset value 4	0.0 Hz	0.0 ... 599.0 Hz	0x2911:004
	SUB 005: Preset value 5	0.0 Hz	0.0 ... 599.0 Hz	0x2911:005
	SUB 006: Preset value 6	0.0 Hz	0.0 ... 599.0 Hz	0x2911:006
	SUB 007: Preset value 7	0.0 Hz	0.0 ... 599.0 Hz	0x2911:007
	SUB 008: Preset value 8	0.0 Hz	0.0 ... 599.0 Hz	0x2911:008
	SUB 009: Preset value 9	0.0 Hz	0.0 ... 599.0 Hz	0x2911:009
	SUB 010: Preset value 10	0.0 Hz	0.0 ... 599.0 Hz	0x2911:010
	SUB 011: Preset value 11	0.0 Hz	0.0 ... 599.0 Hz	0x2911:011
	SUB 012: Preset value 12	0.0 Hz	0.0 ... 599.0 Hz	0x2911:012
	SUB 013: Preset value 13	0.0 Hz	0.0 ... 599.0 Hz	0x2911:013
	SUB 014: Preset value 14	0.0 Hz	0.0 ... 599.0 Hz	0x2911:014
SUB 015: Preset value 15	0.0 Hz	0.0 ... 599.0 Hz	0x2911:015	
PAR 451	<i>PID preset setpoint</i>			
	SUB 001: Preset value 1	0.00 PUnit	-300.00 ... 300.00 PUnit	0x4022:001
	SUB 002: PID preset 2	0.00 PUnit	-300.00 ... 300.00 PUnit	0x4022:002
	SUB 003: PID preset 3	0.00 PUnit	-300.00 ... 300.00 PUnit	0x4022:003
	SUB 004: PID preset 4	0.00 PUnit	-300.00 ... 300.00 PUnit	0x4022:004
	SUB 005: PID preset 5	0.00 PUnit	-300.00 ... 300.00 PUnit	0x4022:005
	SUB 006: PID preset 6	0.00 PUnit	-300.00 ... 300.00 PUnit	0x4022:006
	SUB 007: PID preset 7	0.00 PUnit	-300.00 ... 300.00 PUnit	0x4022:007
SUB 008: PID preset 8	0.00 PUnit	-300.00 ... 300.00 PUnit	0x4022:008	
PAR 452	<i>Preset torque values</i>			
	SUB 001: Preset value 1	100.0 %	-400.0 ... 400.0 %	0x2912:001
	SUB 002: Preset value 2	100.0 %	-400.0 ... 400.0 %	0x2912:002
	SUB 003: Preset value 3	100.0 %	-400.0 ... 400.0 %	0x2912:003
	SUB 004: Preset value 4	100.0 %	-400.0 ... 400.0 %	0x2912:004
	SUB 005: Preset value 5	100.0 %	-400.0 ... 400.0 %	0x2912:005
	SUB 006: Preset value 6	100.0 %	-400.0 ... 400.0 %	0x2912:006
	SUB 007: Preset value 7	100.0 %	-400.0 ... 400.0 %	0x2912:007
SUB 008: Preset value 8	100.0 %	-400.0 ... 400.0 %	0x2912:008	
PAR 500	<i>Module ID</i>			
	SUB 001: Active module ID	-	-(Read only)	0x231F:001
	SUB 002: Module ID conn.	-	-(Read only)	0x231F:002

* Default setting depending on the size.

Firmware-Version 01.01.01.00



Commissioning

Keypad parameter list

PAR	Name / SUB xxx: Name	Default setting	Setting range	Address
PAR 505	<i>NETWordIN1 config.</i>			
	SUB 001: <i>NETWordIN1.00</i>	Not active [0]	Selection list	0x400E:001
	SUB 002: <i>NETWordIN1.01</i>	Not active [0]	Selection list	0x400E:002
	SUB 003: <i>NETWordIN1.02</i>	Quick Stop [3]	Selection list	0x400E:003
	SUB 004: <i>NETWordIN1.03</i>	Forward run [8]	Selection list	0x400E:004
	SUB 005: <i>NETWordIN1.04</i>	Reversal of rotating field [13]	Selection list	0x400E:005
	SUB 006: <i>NETWordIN1.05</i>	DC brake [5]	Selection list	0x400E:006
	SUB 007: <i>NETWordIN1.06</i>	Not active [0]	Selection list	0x400E:007
	SUB 008: <i>NETWordIN1.07</i>	Reset error [4]	Selection list	0x400E:008
	SUB 009: <i>NETWordIN1.08</i>	Preset b0 [18]	Selection list	0x400E:009
	SUB 010: <i>NETWordIN1.09</i>	Preset b1 [19]	Selection list	0x400E:010
	SUB 011: <i>NETWordIN1.10</i>	Not active [0]	Selection list	0x400E:011
	SUB 012: <i>NETWordIN1.11</i>	Not active [0]	Selection list	0x400E:012
	SUB 013: <i>NETWordIN1.12</i>	Not active [0]	Selection list	0x400E:013
	SUB 014: <i>NETWordIN1.13</i>	Not active [0]	Selection list	0x400E:014
	SUB 015: <i>NETWordIN1.14</i>	Not active [0]	Selection list	0x400E:015
SUB 016: <i>NETWordIN1.15</i>	Not active [0]	Selection list	0x400E:016	
PAR 508	<i>Activ. network</i>	No action [0]	Selection list	0x2300
	<i>Activ. netw. sett.</i>	0	0 ... 1	0x2320
PAR 509	<i>DIP switch</i>	-	-(Read only)	0x2303
	<i>DIP switch</i>	-	-(Read only)	0x2323
PAR 510	<i>CANopen sett.</i>			
	SUB 001: <i>Node ID</i>	1	1 ... 127	0x2301:001
	SUB 002: <i>Baud rate</i>	500 kbps [5]	Selection list	0x2301:002
	SUB 003: <i>Slave/Master</i>	Slave [0]	Selection list	0x2301:003
	SUB 004: <i>Start rem. dec.</i>	3000 ms	0 ... 65535 ms	0x2301:004
	SUB 005: <i>SDO2 config.</i>	Not active [0]	Selection list	0x2301:005
	<i>Modbus sett.</i>			
	SUB 001: <i>Node ID</i>	1	1 ... 247	0x2321:001
	SUB 002: <i>Baud rate</i>	Automatic [0]	Selection list	0x2321:002
	SUB 003: <i>Data format</i>	Automatic [0]	Selection list	0x2321:003
SUB 004: <i>Min. resp. time</i>	0 ms	0 ... 1000 ms	0x2321:004	
PAR 511	<i>CANopen status</i>			
	SUB 001: <i>Node ID</i>	-	-(Read only)	0x2302:001
	SUB 002: <i>Baud rate</i>	-	-(Read only)	0x2302:002
	<i>Active sett.</i>			
	SUB 001: <i>Node ID</i>	-	-(Read only)	0x2322:001
	SUB 002: <i>Baud rate</i>	-	-(Read only)	0x2322:002
	SUB 003: <i>Data format</i>	-	-(Read only)	0x2322:003
PAR 515	<i>Time-out status</i>	-	-(Read only)	0x2307
	<i>Modbus monit.</i>			
	SUB 001: <i>Time-out action</i>	Error [3]	Selection list	0x2858:001
	SUB 002: <i>Timeout</i>	2.0 s	0.0 ... 300.0 s	0x2858:002
PAR 516	<i>CANopen status</i>	-	-(Read only)	0x2308
PAR 517	<i>Controller status</i>	-	-(Read only)	0x2309
PAR 518	<i>CAN error counter</i>	-	-(Read only)	0x230B
PAR 520	<i>Cons heartbeat</i>			
	SUB 000: <i>Highest subindex</i>	-	-(Read only)	0x1016:000
	SUB 001: <i>Node 1</i>	0x00000000	0x00000000 ... 0x00FFFFFF	0x1016:001
	SUB 002: <i>Node 2</i>	0x00000000	0x00000000 ... 0x00FFFFFF	0x1016:002
	SUB 003: <i>Node 3</i>	0x00000000	0x00000000 ... 0x00FFFFFF	0x1016:003
	SUB 004: <i>Node 4</i>	0x00000000	0x00000000 ... 0x00FFFFFF	0x1016:004
PAR 522	<i>Prod heartbeat</i>	0 ms	0 ... 65535 ms	0x1017

* Default setting depending on the size.

Firmware-Version 01.01.01.00

Commissioning

Keypad parameter list



PAR	Name / SUB xxx: Name	Default setting	Setting range	Address
PAR 530	<i>Para. mapping</i>			
	SUB 001: Parameter 1	0x00000000	0x00000000 ... 0xFFFFFFFF00	0x232B:001
	SUB 002: Parameter 2	0x00000000	0x00000000 ... 0xFFFFFFFF00	0x232B:002
	SUB 003: Parameter 3	0x00000000	0x00000000 ... 0xFFFFFFFF00	0x232B:003
	SUB 004: Parameter 4	0x00000000	0x00000000 ... 0xFFFFFFFF00	0x232B:004
	SUB 005: Parameter 5	0x00000000	0x00000000 ... 0xFFFFFFFF00	0x232B:005
	SUB 006: Parameter 6	0x00000000	0x00000000 ... 0xFFFFFFFF00	0x232B:006
	SUB 007: Parameter 7	0x00000000	0x00000000 ... 0xFFFFFFFF00	0x232B:007
	SUB 008: Parameter 8	0x00000000	0x00000000 ... 0xFFFFFFFF00	0x232B:008
	SUB 009: Parameter 9	0x00000000	0x00000000 ... 0xFFFFFFFF00	0x232B:009
	SUB 010: Parameter 10	0x00000000	0x00000000 ... 0xFFFFFFFF00	0x232B:010
	SUB 011: Parameter 11	0x00000000	0x00000000 ... 0xFFFFFFFF00	0x232B:011
	SUB 012: Parameter 12	0x00000000	0x00000000 ... 0xFFFFFFFF00	0x232B:012
	SUB 013: Parameter 13	0x00000000	0x00000000 ... 0xFFFFFFFF00	0x232B:013
	SUB 014: Parameter 14	0x00000000	0x00000000 ... 0xFFFFFFFF00	0x232B:014
	SUB 015: Parameter 15	0x00000000	0x00000000 ... 0xFFFFFFFF00	0x232B:015
	SUB 016: Parameter 16	0x00000000	0x00000000 ... 0xFFFFFFFF00	0x232B:016
	SUB 017: Parameter 17	0x00000000	0x00000000 ... 0xFFFFFFFF00	0x232B:017
	SUB 018: Parameter 18	0x00000000	0x00000000 ... 0xFFFFFFFF00	0x232B:018
	SUB 019: Parameter 19	0x00000000	0x00000000 ... 0xFFFFFFFF00	0x232B:019
	SUB 020: Parameter 20	0x00000000	0x00000000 ... 0xFFFFFFFF00	0x232B:020
	SUB 021: Parameter 21	0x00000000	0x00000000 ... 0xFFFFFFFF00	0x232B:021
	SUB 022: Parameter 22	0x00000000	0x00000000 ... 0xFFFFFFFF00	0x232B:022
	SUB 023: Parameter 23	0x00000000	0x00000000 ... 0xFFFFFFFF00	0x232B:023
	SUB 024: Parameter 24	0x00000000	0x00000000 ... 0xFFFFFFFF00	0x232B:024
PAR 531	<i>Reg. assigned</i>			
	SUB 001: Register 1	-	-(Read only)	0x232C:001
	SUB 002: Register 2	-	-(Read only)	0x232C:002
	SUB 003: Register 3	-	-(Read only)	0x232C:003
	SUB 004: Register 4	-	-(Read only)	0x232C:004
	SUB 005: Register 5	-	-(Read only)	0x232C:005
	SUB 006: Register 6	-	-(Read only)	0x232C:006
	SUB 007: Register 7	-	-(Read only)	0x232C:007
	SUB 008: Register 8	-	-(Read only)	0x232C:008
	SUB 009: Register 9	-	-(Read only)	0x232C:009
	SUB 010: Register 10	-	-(Read only)	0x232C:010
	SUB 011: Register 11	-	-(Read only)	0x232C:011
	SUB 012: Register 12	-	-(Read only)	0x232C:012
	SUB 013: Register 13	-	-(Read only)	0x232C:013
	SUB 014: Register 14	-	-(Read only)	0x232C:014
	SUB 015: Register 15	-	-(Read only)	0x232C:015
	SUB 016: Register 16	-	-(Read only)	0x232C:016
	SUB 017: Register 17	-	-(Read only)	0x232C:017
	SUB 018: Register 18	-	-(Read only)	0x232C:018
	SUB 019: Register 19	-	-(Read only)	0x232C:019
	SUB 020: Register 20	-	-(Read only)	0x232C:020
	SUB 021: Register 21	-	-(Read only)	0x232C:021
	SUB 022: Register 22	-	-(Read only)	0x232C:022
	SUB 023: Register 23	-	-(Read only)	0x232C:023
	SUB 024: Register 24	-	-(Read only)	0x232C:024
PAR 532	Verification code	-	-(Read only)	0x232D
* Default setting depending on the size.				Firmware-Version 01.01.01.00



Commissioning

Keypad parameter list

PAR	Name / SUB xxx: Name	Default setting	Setting range	Address
PAR 540	<i>RPDO1 config.</i>			
	SUB 001: COB-ID	0x00000200	0x00000000 ... 0xFFFFFFFF	0x1400:001
	SUB 002: Transm. type	255	0 ... 255	0x1400:002
	SUB 005: Event timer	100 ms	0 ... 65535 ms	0x1400:005
PAR 541	<i>RPDO2 config.</i>			
	SUB 001: COB-ID	0x80000300	0x00000000 ... 0xFFFFFFFF	0x1401:001
	SUB 002: Transm. type	255	0 ... 255	0x1401:002
	SUB 005: Event timer	100 ms	0 ... 65535 ms	0x1401:005
PAR 542	<i>RPDO3 config.</i>			
	SUB 001: COB-ID	0x80000400	0x00000000 ... 0xFFFFFFFF	0x1402:001
	SUB 002: Transm. type	255	0 ... 255	0x1402:002
	SUB 005: Event timer	100 ms	0 ... 65535 ms	0x1402:005
PAR 550	<i>TPDO1 config.</i>			
	SUB 001: COB-ID	0x40000180	0x00000001 ... 0xFFFFFFFF	0x1800:001
	SUB 002: Transm. type	255	0 ... 255	0x1800:002
	SUB 003: Inhibit time	0.0 ms	0.0 ... 6553.5 ms	0x1800:003
	SUB 005: Event timer	20 ms	0 ... 65535 ms	0x1800:005
PAR 551	<i>TPDO2 config.</i>			
	SUB 001: COB-ID	0xC0000280	0x00000001 ... 0xFFFFFFFF	0x1801:001
	SUB 002: Transm. type	255	0 ... 255	0x1801:002
	SUB 003: Inhibit time	0.0 ms	0.0 ... 6553.5 ms	0x1801:003
	SUB 005: Event timer	0 ms	0 ... 65535 ms	0x1801:005
PAR 552	<i>TPDO3 config.</i>			
	SUB 001: COB-ID	0xC0000380	0x00000001 ... 0xFFFFFFFF	0x1802:001
	SUB 002: Transm. type	255	0 ... 255	0x1802:002
	SUB 003: Inhibit time	0.0 ms	0.0 ... 6553.5 ms	0x1802:003
	SUB 005: Event timer	0 ms	0 ... 65535 ms	0x1802:005
PAR 580	<i>CAN counter</i>			
	SUB 001: PDO1 received	-	-(Read only)	0x230A:001
	SUB 002: PDO2 received	-	-(Read only)	0x230A:002
	SUB 003: PDO3 received	-	-(Read only)	0x230A:003
	SUB 005: PDO1 transmitted	-	-(Read only)	0x230A:005
	SUB 006: PDO2 transmitted	-	-(Read only)	0x230A:006
	SUB 007: PDO3 transmitted	-	-(Read only)	0x230A:007
	SUB 009: SDO1 counter	-	-(Read only)	0x230A:009
	SUB 010: SDO2 counter	-	-(Read only)	0x230A:010
	<i>Modbus counter</i>			
	SUB 001: Messages received	-	-(Read only)	0x232A:001
	SUB 002: Val. mess. rec.	-	-(Read only)	0x232A:002
	SUB 003: Mess. w. exc.	-	-(Read only)	0x232A:003
	SUB 004: Mess. with errors	-	-(Read only)	0x232A:004
	SUB 005: Messages sent	-	-(Read only)	0x232A:005
PAR 583	<i>RX data diagnostics</i>			
	SUB 001: RX data offset	0	0 ... 240	0x232E:001
	SUB 002: Last RxD byte0	-	-(Read only)	0x232E:002
	SUB 003: Last RxD byte2	-	-(Read only)	0x232E:003
	SUB 004: Last RxD byte4	-	-(Read only)	0x232E:004
	SUB 005: Last RxD byte6	-	-(Read only)	0x232E:005
	SUB 006: Last RxD byte8	-	-(Read only)	0x232E:006
	SUB 007: Last RxD byte10	-	-(Read only)	0x232E:007
	SUB 008: Last RxD byte12	-	-(Read only)	0x232E:008
	SUB 009: Last RxD byte14	-	-(Read only)	0x232E:009
	SUB 010: Last RxD byte16	-	-(Read only)	0x232E:010
	SUB 011: Last RxD byte18	-	-(Read only)	0x232E:011

* Default setting depending on the size.

Firmware-Version 01.01.01.00

Commissioning

Keypad parameter list



PAR	Name / SUB xxx: Name	Default setting	Setting range	Address
	SUB 012: Last RxD byte20	-	-(Read only)	0x232E:012
	SUB 013: Last RxD byte22	-	-(Read only)	0x232E:013
	SUB 014: Last RxD byte24	-	-(Read only)	0x232E:014
	SUB 015: Last RxD byte26	-	-(Read only)	0x232E:015
	SUB 016: Last RxD byte28	-	-(Read only)	0x232E:016
	SUB 017: Last RxD byte30	-	-(Read only)	0x232E:017
PAR 585	<i>TX data diagnostics</i>			
	SUB 001: TX data offset	0	0 ... 240	0x232F:001
	SUB 002: Last TxD byte0	-	-(Read only)	0x232F:002
	SUB 003: Last TxD Byte1	-	-(Read only)	0x232F:003
	SUB 004: Last TxD byte2	-	-(Read only)	0x232F:004
	SUB 005: Last TxD byte3	-	-(Read only)	0x232F:005
	SUB 006: Last TxD byte4	-	-(Read only)	0x232F:006
	SUB 007: Last TxD byte5	-	-(Read only)	0x232F:007
	SUB 008: Last TxD byte6	-	-(Read only)	0x232F:008
	SUB 009: Last TxD byte7	-	-(Read only)	0x232F:009
	SUB 010: Last TxD byte8	-	-(Read only)	0x232F:010
	SUB 011: Last TxD byte9	-	-(Read only)	0x232F:011
	SUB 012: Last TxD byte10	-	-(Read only)	0x232F:012
	SUB 013: Last TxD byte11	-	-(Read only)	0x232F:013
	SUB 014: Last TxD byte12	-	-(Read only)	0x232F:014
	SUB 015: Last TxD byte13	-	-(Read only)	0x232F:015
	SUB 016: Last TxD byte14	-	-(Read only)	0x232F:016
	SUB 017: Last TxD byte15	-	-(Read only)	0x232F:017
PAR 590	<i>NETWordIN stat</i>			
	SUB 001: NETWordIN1	0x0000	0x0000 ... 0xFFFF	0x4008:001
	SUB 002: NETWordIN2	0x0000	0x0000 ... 0xFFFF	0x4008:002
	SUB 003: NETWordIN3	0.0 %	0.0 ... 100.0 %	0x4008:003
	SUB 004: NETWordIN4	0.0 %	0.0 ... 100.0 %	0x4008:004
PAR 591	<i>NetzWortOUT Stat</i>			
	SUB 001: NetzWortOUT1	-	-(Read only)	0x400A:001
	SUB 002: NetzWortOUT2	-	-(Read only)	0x400A:002
PAR 592	<i>Legacy NetWordIN</i>			
	SUB 001: AC control word	0x0000	0x0000 ... 0xFFFF	0x400B:001
	SUB 002: C0135 control word	0x0000	0x0000 ... 0xFFFF	0x400B:002
	SUB 003: Netwfreq. 0.1Hz	0.0 Hz	0.0 ... 599.0 Hz	0x400B:003
	SUB 004: Netwspeed r/min	0 rpm	0 ... 50000 rpm	0x400B:004
	SUB 005: Netwfreq. 0.01Hz	0.00 Hz	0.00 ... 599.00 Hz	0x400B:005
	SUB 006: Netw. speed setp.	0.0 Hz	-599.0 ... 599.0 Hz	0x400B:006
	SUB 007: Netw. PID setp.	0.00 PUnit	-300.00 ... 300.00 PUnit	0x400B:007
	SUB 008: Netw. torque setp.	0 Nm	-32768 ... 32767 Nm	0x400B:008
PAR 593	<i>Old netw. off</i>			
	SUB 001: AC drive status word	-	-(Read only)	0x400C:001
	SUB 002: C0150 status word	-	-(Read only)	0x400C:002
	SUB 003: Actual frequency Hz	x.x Hz	-(Read only)	0x400C:003
	SUB 004: Act. speed r/min	x rpm	-(Read only)	0x400C:004
	SUB 005: Drive status	-	-(Read only)	0x400C:005
	SUB 006: Act. freq. 0.01Hz	x.xx Hz	-(Read only)	0x400C:006
PAR 600	<i>Process controller</i>			
	SUB 001: Operating mode	Inhibited [0]	Selection list	0x4020:001
	SUB 002: PID feedback	Analog input 1 [1]	Selection list	0x4020:002
	SUB 003: PID speed range	100 %	0 ... 100 %	0x4020:003
	SUB 004: PID line speed	Without speed feedf. ctrl [0]	Selection list	0x4020:004

* Default setting depending on the size.

Firmware-Version 01.01.01.00



Commissioning

Keypad parameter list

PAR	Name / SUB xxx: Name	Default setting	Setting range	Address
PAR 601	<i>P-gain</i>	5.0 %	0.0 ... 1000.0 %	0x4048
PAR 602	<i>I-deceleration</i>	400 ms	20 ... 6000 ms	0x4049
PAR 603	<i>D-gain</i>	0.0 s	0.0 ... 20.0 s	0x404A
PAR 604	<i>PID setp.ramp</i>	20.0 s	0.0 ... 100.0 s	0x404B
PAR 605	<i>PID setp. limit</i>			
	SUB 001: <i>PID setp. min.</i>	-300.00 PUnit	-300.00 ... 300.00 PUnit	0x404E:001
	SUB 002: <i>PID setp. max.</i>	300.00 PUnit	-300.00 ... 300.00 PUnit	0x404E:002
PAR 606	<i>PID acc./dec.</i>			
	SUB 001: <i>PID acceleration time</i>	1.0 s	0.0 ... 3600.0 s	0x4021:001
	SUB 002: <i>PID deceleration time</i>	1.0 s	0.0 ... 3600.0 s	0x4021:002
PAR 607	<i>PID influence</i>			
	SUB 001: <i>Show time</i>	5.0 s	0.0 ... 999.9 s	0x404C:001
	SUB 002: <i>Mask out time</i>	5.0 s	0.0 ... 999.9 s	0x404C:002
PAR 608	<i>PID alarms</i>			
	SUB 001: <i>PID min alarm</i>	0.00 PUnit	-300.00 ... 300.00 PUnit	0x404D:001
	SUB 002: <i>PID max alarm</i>	100.00 PUnit	-300.00 ... 300.00 PUnit	0x404D:002
PAR 610	<i>Sleep mode sett.</i>			
	SUB 001: <i>Sleep start mode</i>	Inhibited [0]	<i>Selection list</i>	0x4023:001
	SUB 002: <i>Sleep stop meth.</i>	Coasting [0]	<i>Selection list</i>	0x4023:002
	SUB 003: <i>Sleep freq. thresh.</i>	0.0 Hz	0.0 ... 599.0 Hz	0x4023:003
	SUB 004: <i>Sleep fdbk thresh.</i>	0.00 PUnit	-300.00 ... 300.00 PUnit	0x4023:004
	SUB 005: <i>Sleep dec.</i>	0.0 s	0.0 ... 300.0 s	0x4023:005
	SUB 006: <i>Sleep rec. mode</i>	Speed setp>P610/3 [0]	<i>Selection list</i>	0x4023:006
	SUB 007: <i>Sleep bandw.</i>	0.00 PUnit	0.00 ... 300.00 PUnit	0x4023:007
	SUB 008: <i>Sleep fdbck.rec</i>	0.00 PUnit	-300.00 ... 300.00 PUnit	0x4023:008
PAR 615	<i>Set auto-rinse</i>			
	SUB 001: <i>Auto-rinse mode</i>	Inhibited [0]	<i>Selection list</i>	0x4024:001
	SUB 002: <i>Auto-rinse del.</i>	30.0 min	0.0 ... 6000.0 min	0x4024:002
	SUB 003: <i>Auto-rinse speed</i>	0.0 Hz	-599.0 ... 599.0 Hz	0x4024:003
	SUB 004: <i>Auto-rinse time</i>	0.0 s	0.0 ... 6000.0 s	0x4024:004
PAR 700	<i>Device commands</i>			
	SUB 001: <i>Load Lenze sett.</i>	Off / ready [0]	<i>Selection list</i>	0x2022:001
	SUB 003: <i>Save user data</i>	Off / ready [0]	<i>Selection list</i>	0x2022:003
	SUB 004: <i>Load user data</i>	Off / ready [0]	<i>Selection list</i>	0x2022:004
	SUB 005: <i>Load OEM data</i>	Off / ready [0]	<i>Selection list</i>	0x2022:005
	SUB 006: <i>Save OEM data</i>	Off / ready [0]	<i>Selection list</i>	0x2022:006
	SUB 007: <i>Load par. set 1</i>	Off / ready [0]	<i>Selection list</i>	0x2022:007
	SUB 008: <i>Load par. set 2</i>	Off / ready [0]	<i>Selection list</i>	0x2022:008
	SUB 009: <i>Load par. set 3</i>	Off / ready [0]	<i>Selection list</i>	0x2022:009
	SUB 010: <i>Load par. set 4</i>	Off / ready [0]	<i>Selection list</i>	0x2022:010
	SUB 011: <i>Save par. set 1</i>	Off / ready [0]	<i>Selection list</i>	0x2022:011
	SUB 012: <i>Save par. set 2</i>	Off / ready [0]	<i>Selection list</i>	0x2022:012
	SUB 013: <i>Save par. set 3</i>	Off / ready [0]	<i>Selection list</i>	0x2022:013
	SUB 014: <i>Save par. set 4</i>	Off / ready [0]	<i>Selection list</i>	0x2022:014
	SUB 015: <i>Delete logbook</i>	0	0 ... 1	0x2022:015
	SUB 016: <i>Reset netw. node</i>	0	0 ... 1	0x2022:016
	SUB 026: <i>Compile EPM</i>	0	0 ... 1	0x2022:026
	SUB 027: <i>Accept new HW</i>	0	0 ... 1	0x2022:027
PAR 701	<i>Keypad setpoint</i>	1	1 ... 100	0x2862
PAR 702	<i>Scaled speed factor</i>	0.00	0.00 ... 650.00	0x4002
PAR 703	<i>KP running indicator</i>	0x00000000	0x00000000 ... 0xFFFFFFFF00	0x2864

* Default setting depending on the size.

Firmware-Version 01.01.01.00

Commissioning

Keypad parameter list



PAR	Name / SUB xxx: Name	Default setting	Setting range	Address
PAR 704	<i>DC braking</i>			
	SUB 001: Current	0.0 %	0.0 ... 200.0 %	0x2B84:001
	SUB 002: Hold time autom.	0.0 s	0.0 ... 999.9 s	0x2B84:002
	SUB 003: Threshold autom.	0.0 Hz	0.0 ... 599.0 Hz	0x2B84:003
PAR 705	<i>Language selection</i>	English [1]	Selection list	0x2863
PAR 706	<i>Brake management</i>			
	SUB 001: Operating mode	Del.overr.time [1]	Selection list	0x2541:001
	SUB 002: Active threshold	x V	- (Read only)	0x2541:002
	SUB 003: Red. threshold	0 V	0 ... 100 V	0x2541:003
	SUB 004: Add.frequency	0.0 Hz	0.0 ... 10.0 Hz	0x2541:004
	SUB 005: Del.overr.time	2.0 s	0.0 ... 60.0 s	0x2541:005
PAR 710	<i>Load loss monit.</i>			
	SUB 001: Load loss threshold	0.0 %	0.0 ... 200.0 %	0x4006:001
	SUB 002: Load loss delay	0.0 s	0.0 ... 300.0 s	0x4006:002
PAR 712	<i>Mech. brake</i>			
	SUB 001: MB operating mode	No brake [2]	Selection list	0x2820:001
	SUB 002: Engagement time	100 ms	0 ... 10000 ms	0x2820:002
	SUB 003: Disengagem. time	100 ms	0 ... 10000 ms	0x2820:003
	SUB 007: MB application level	0.2 Hz	0.0 ... 599.0 Hz	0x2820:007
	SUB 008: MB holding load	0.0 %	-500.0 ... 500.0 %	0x2820:008
	SUB 015: MB status	-	- (Read only)	0x2820:015
PAR 718	<i>Flying restart circuit</i>			
	SUB 001: Flying restart current	30 %	0 ... 100 %	0x2BA1:001
	SUB 002: Start frequency	20.0 Hz	-599.0 ... 599.0 Hz	0x2BA1:002
	SUB 003: Flying restart time	5911 ms *	1 ... 60000 ms	0x2BA1:003
	SUB 008: Flying restart frequency	x.x Hz	- (Read only)	0x2BA1:008
PAR 730	<i>PIN1 protection</i>	0	-1 ... 9999	0x203D
PAR 731	<i>PIN2 protection</i>	0	-1 ... 9999	0x203E
PAR 732	<i>Autom. EPM data</i>	Inhibit [0]	Selection list	0x2829
PAR 740	<i>Favorites sett.</i>			
	SUB 001: Favorites pos 1	0x2DDD0000	0x00000000 ... 0xFFFFFFFF00	0x261C:001
	SUB 002: Favorites pos 2	0x60780000	0x00000000 ... 0xFFFFFFFF00	0x261C:002
	SUB 003: Favorites pos 3	0x2D890000	0x00000000 ... 0xFFFFFFFF00	0x261C:003
	SUB 004: Favorites pos 4	0x603F0000	0x00000000 ... 0xFFFFFFFF00	0x261C:004
	SUB 005: Favorites pos 5	0x28240000	0x00000000 ... 0xFFFFFFFF00	0x261C:005
	SUB 006: Favorites pos 6	0x28600100	0x00000000 ... 0xFFFFFFFF00	0x261C:006
	SUB 007: Favorites pos 7	0x28380100	0x00000000 ... 0xFFFFFFFF00	0x261C:007
	SUB 008: Favorites pos 8	0x28380300	0x00000000 ... 0xFFFFFFFF00	0x261C:008
	SUB 009: Favorites pos 9	0x25400100	0x00000000 ... 0xFFFFFFFF00	0x261C:009
	SUB 010: Favorites pos 10	0x29150000	0x00000000 ... 0xFFFFFFFF00	0x261C:010
	SUB 011: Favorites pos 11	0x29160000	0x00000000 ... 0xFFFFFFFF00	0x261C:011
	SUB 012: Favorites pos 12	0x29170000	0x00000000 ... 0xFFFFFFFF00	0x261C:012
	SUB 013: Favorites pos 13	0x29180000	0x00000000 ... 0xFFFFFFFF00	0x261C:013
	SUB 014: Favorites pos 14	0x2C000000	0x00000000 ... 0xFFFFFFFF00	0x261C:014
	SUB 015: Favorites pos 15	0x2B000000	0x00000000 ... 0xFFFFFFFF00	0x261C:015
	SUB 016: Favorites pos 16	0x2B010100	0x00000000 ... 0xFFFFFFFF00	0x261C:016
	SUB 017: Favorites pos 17	0x2B010200	0x00000000 ... 0xFFFFFFFF00	0x261C:017
	SUB 018: Favorites pos 18	0x283A0000	0x00000000 ... 0xFFFFFFFF00	0x261C:018
	SUB 019: Favorites pos 19	0x29390000	0x00000000 ... 0xFFFFFFFF00	0x261C:019
	SUB 020: Favorites pos 20	0x2D4B0100	0x00000000 ... 0xFFFFFFFF00	0x261C:020
	SUB 021: Favorites pos 21	0x2B120100	0x00000000 ... 0xFFFFFFFF00	0x261C:021
	SUB 022: Favorites pos 22	0x60730000	0x00000000 ... 0xFFFFFFFF00	0x261C:022

* Default setting depending on the size.

Firmware-Version 01.01.01.00



Commissioning

Keypad parameter list

PAR	Name / SUB xxx: Name	Default setting	Setting range	Address
	SUB 023: Favorites pos 23	0x26310100	0x00000000 ... 0xFFFFFFFF00	0x261C:023
	SUB 024: Favorites pos 24	0x26310200	0x00000000 ... 0xFFFFFFFF00	0x261C:024
	SUB 025: Favorites pos 25	0x26310300	0x00000000 ... 0xFFFFFFFF00	0x261C:025
	SUB 026: Favorites pos 26	0x26310400	0x00000000 ... 0xFFFFFFFF00	0x261C:026
	SUB 027: Favorites pos 27	0x26310500	0x00000000 ... 0xFFFFFFFF00	0x261C:027
	SUB 028: Favorites pos 28	0x26310600	0x00000000 ... 0xFFFFFFFF00	0x261C:028
	SUB 029: Favorites pos 29	0x26310700	0x00000000 ... 0xFFFFFFFF00	0x261C:029
	SUB 030: Favorites pos 30	0x26310800	0x00000000 ... 0xFFFFFFFF00	0x261C:030
	SUB 031: Favorites pos 31	0x26310900	0x00000000 ... 0xFFFFFFFF00	0x261C:031
	SUB 032: Favorites pos 32	0x26310D00	0x00000000 ... 0xFFFFFFFF00	0x261C:032
	SUB 033: Favorites pos 33	0x26311200	0x00000000 ... 0xFFFFFFFF00	0x261C:033
	SUB 034: Favorites pos 34	0x26311300	0x00000000 ... 0xFFFFFFFF00	0x261C:034
	SUB 035: Favorites pos 35	0x26311400	0x00000000 ... 0xFFFFFFFF00	0x261C:035
	SUB 036: Favorites pos 36	0x26340100	0x00000000 ... 0xFFFFFFFF00	0x261C:036
	SUB 037: Favorites pos 37	0x26340200	0x00000000 ... 0xFFFFFFFF00	0x261C:037
	SUB 038: Favorites pos 38	0x26360100	0x00000000 ... 0xFFFFFFFF00	0x261C:038
	SUB 039: Favorites pos 39	0x26360200	0x00000000 ... 0xFFFFFFFF00	0x261C:039
	SUB 040: Favorites pos 40	0x26360300	0x00000000 ... 0xFFFFFFFF00	0x261C:040
	SUB 041: Favorites pos 41	0x26390100	0x00000000 ... 0xFFFFFFFF00	0x261C:041
	SUB 042: Favorites pos 42	0x26390200	0x00000000 ... 0xFFFFFFFF00	0x261C:042
	SUB 043: Favorites pos 43	0x26390300	0x00000000 ... 0xFFFFFFFF00	0x261C:043
	SUB 044: Favorites pos 44	0x26390400	0x00000000 ... 0xFFFFFFFF00	0x261C:044
	SUB 045: Favorites pos 45	0x29110100	0x00000000 ... 0xFFFFFFFF00	0x261C:045
	SUB 046: Favorites pos 46	0x29110200	0x00000000 ... 0xFFFFFFFF00	0x261C:046
	SUB 047: Favorites pos 47	0x29110300	0x00000000 ... 0xFFFFFFFF00	0x261C:047
	SUB 048: Favorites pos 48	0x29110400	0x00000000 ... 0xFFFFFFFF00	0x261C:048
	SUB 049: Favorites pos 49	0x00000000	0x00000000 ... 0xFFFFFFFF00	0x261C:049
	SUB 050: Favorites pos 50	0x00000000	0x00000000 ... 0xFFFFFFFF00	0x261C:050
PAR 750	Param. set setup			
	SUB 001: Parameter 1	0x00000000	0x00000000 ... 0xFFFFFFFF00	0x4041:001
	SUB 002: Parameter 2	0x00000000	0x00000000 ... 0xFFFFFFFF00	0x4041:002
	SUB 003: Parameter 3	0x00000000	0x00000000 ... 0xFFFFFFFF00	0x4041:003
	SUB 004: Parameter 4	0x00000000	0x00000000 ... 0xFFFFFFFF00	0x4041:004
	SUB 005: Parameter 5	0x00000000	0x00000000 ... 0xFFFFFFFF00	0x4041:005
	SUB 006: Parameter 6	0x00000000	0x00000000 ... 0xFFFFFFFF00	0x4041:006
	SUB 007: Parameter 7	0x00000000	0x00000000 ... 0xFFFFFFFF00	0x4041:007
	SUB 008: Parameter 8	0x00000000	0x00000000 ... 0xFFFFFFFF00	0x4041:008
	SUB 009: CodeParameter	0x00000000	0x00000000 ... 0xFFFFFFFF00	0x4041:009
	SUB 010: Parameter 10	0x00000000	0x00000000 ... 0xFFFFFFFF00	0x4041:010
	SUB 011: Parameter 11	0x00000000	0x00000000 ... 0xFFFFFFFF00	0x4041:011
	SUB 012: Parameter 12	0x00000000	0x00000000 ... 0xFFFFFFFF00	0x4041:012
	SUB 013: Parameter 13	0x00000000	0x00000000 ... 0xFFFFFFFF00	0x4041:013
	SUB 014: Parameter 14	0x00000000	0x00000000 ... 0xFFFFFFFF00	0x4041:014
	SUB 015: Parameter 15	0x00000000	0x00000000 ... 0xFFFFFFFF00	0x4041:015
	SUB 016: Parameter 16	0x00000000	0x00000000 ... 0xFFFFFFFF00	0x4041:016
	SUB 017: Parameter 17	0x00000000	0x00000000 ... 0xFFFFFFFF00	0x4041:017
	SUB 018: Parameter 18	0x00000000	0x00000000 ... 0xFFFFFFFF00	0x4041:018
	SUB 019: Parameter 19	0x00000000	0x00000000 ... 0xFFFFFFFF00	0x4041:019
	SUB 020: Parameter 20	0x00000000	0x00000000 ... 0xFFFFFFFF00	0x4041:020
	SUB 021: Parameter 21	0x00000000	0x00000000 ... 0xFFFFFFFF00	0x4041:021
	SUB 022: Parameter 22	0x00000000	0x00000000 ... 0xFFFFFFFF00	0x4041:022
	SUB 023: Parameter 23	0x00000000	0x00000000 ... 0xFFFFFFFF00	0x4041:023
	SUB 024: Parameter 24	0x00000000	0x00000000 ... 0xFFFFFFFF00	0x4041:024
	SUB 025: Parameter 25	0x00000000	0x00000000 ... 0xFFFFFFFF00	0x4041:025
* Default setting depending on the size.				Firmware-Version 01.01.01.00

Commissioning

Keypad parameter list



PAR	Name / SUB xxx: Name	Default setting	Setting range	Address
	SUB 026: Parameter 26	0x00000000	0x00000000 ... 0xFFFFFFFF00	0x4041:026
	SUB 027: Parameter 27	0x00000000	0x00000000 ... 0xFFFFFFFF00	0x4041:027
	SUB 028: Parameter 28	0x00000000	0x00000000 ... 0xFFFFFFFF00	0x4041:028
	SUB 029: Parameter 29	0x00000000	0x00000000 ... 0xFFFFFFFF00	0x4041:029
	SUB 030: Parameter 30	0x00000000	0x00000000 ... 0xFFFFFFFF00	0x4041:030
	SUB 031: Parameter 31	0x00000000	0x00000000 ... 0xFFFFFFFF00	0x4041:031
	SUB 032: Parameter 32	0x00000000	0x00000000 ... 0xFFFFFFFF00	0x4041:032
PAR 751	<i>Param. set 1</i>			
	SUB 001: Set1: Value 1	0	-2147483648 ... 2147483647	0x4042:001
	SUB 002: Set1: value 2	0	-2147483648 ... 2147483647	0x4042:002
	SUB 003: Set1: value 3	0	-2147483648 ... 2147483647	0x4042:003
	SUB 004: Set1: value 4	0	-2147483648 ... 2147483647	0x4042:004
	SUB 005: Set1: value 5	0	-2147483648 ... 2147483647	0x4042:005
	SUB 006: Set1: value 6	0	-2147483648 ... 2147483647	0x4042:006
	SUB 007: Set1: value 7	0	-2147483648 ... 2147483647	0x4042:007
	SUB 008: Set1: value 8	0	-2147483648 ... 2147483647	0x4042:008
	SUB 009: Set1: value 9	0	-2147483648 ... 2147483647	0x4042:009
	SUB 010: Set1: value 10	0	-2147483648 ... 2147483647	0x4042:010
	SUB 011: Set1: value 11	0	-2147483648 ... 2147483647	0x4042:011
	SUB 012: Set1: value 12	0	-2147483648 ... 2147483647	0x4042:012
	SUB 013: Set1: value 13	0	-2147483648 ... 2147483647	0x4042:013
	SUB 014: Set1: value 14	0	-2147483648 ... 2147483647	0x4042:014
	SUB 015: Set1: value 15	0	-2147483648 ... 2147483647	0x4042:015
	SUB 016: Set1: value 16	0	-2147483648 ... 2147483647	0x4042:016
	SUB 017: Set1: value 17	0	-2147483648 ... 2147483647	0x4042:017
	SUB 018: Set1: value 18	0	-2147483648 ... 2147483647	0x4042:018
	SUB 019: Set1: value 19	0	-2147483648 ... 2147483647	0x4042:019
	SUB 020: Set1: value 20	0	-2147483648 ... 2147483647	0x4042:020
	SUB 021: Set1: value 21	0	-2147483648 ... 2147483647	0x4042:021
	SUB 022: Set1: value 22	0	-2147483648 ... 2147483647	0x4042:022
	SUB 023: Set1: value 23	0	-2147483648 ... 2147483647	0x4042:023
	SUB 024: Set1: value 24	0	-2147483648 ... 2147483647	0x4042:024
	SUB 025: Set1: value 25	0	-2147483648 ... 2147483647	0x4042:025
	SUB 026: Set1: value 26	0	-2147483648 ... 2147483647	0x4042:026
	SUB 027: Set1: value 27	0	-2147483648 ... 2147483647	0x4042:027
	SUB 028: Set1: value 28	0	-2147483648 ... 2147483647	0x4042:028
	SUB 029: Set1: value 29	0	-2147483648 ... 2147483647	0x4042:029
	SUB 030: Set1: value 30	0	-2147483648 ... 2147483647	0x4042:030
	SUB 031: Set1: value 31	0	-2147483648 ... 2147483647	0x4042:031
	SUB 032: Set1: value 32	0	-2147483648 ... 2147483647	0x4042:032
PAR 752	<i>Param. set 2</i>			
	SUB 001: Set2: Value 1	0	-2147483648 ... 2147483647	0x4043:001
	SUB 002: Set2: value 2	0	-2147483648 ... 2147483647	0x4043:002
	SUB 003: Set2: value 3	0	-2147483648 ... 2147483647	0x4043:003
	SUB 004: Set2: value 4	0	-2147483648 ... 2147483647	0x4043:004
	SUB 005: Set2: value 5	0	-2147483648 ... 2147483647	0x4043:005
	SUB 006: Set2: value 6	0	-2147483648 ... 2147483647	0x4043:006
	SUB 007: Set2: value 7	0	-2147483648 ... 2147483647	0x4043:007
	SUB 008: Set2: value 8	0	-2147483648 ... 2147483647	0x4043:008
	SUB 009: Set2: value 9	0	-2147483648 ... 2147483647	0x4043:009
	SUB 010: Set2: value 10	0	-2147483648 ... 2147483647	0x4043:010
	SUB 011: Set2: value 11	0	-2147483648 ... 2147483647	0x4043:011
	SUB 012: Set2: value 12	0	-2147483648 ... 2147483647	0x4043:012
	SUB 013: Set2: value 13	0	-2147483648 ... 2147483647	0x4043:013
* Default setting depending on the size.				Firmware-Version 01.01.01.00



Commissioning

Keypad parameter list

PAR	Name / SUB xxx: Name	Default setting	Setting range	Address
	SUB 014: Set2: value 14	0	-2147483648 ... 2147483647	0x4043:014
	SUB 015: Set2: value 15	0	-2147483648 ... 2147483647	0x4043:015
	SUB 016: Set2: value 16	0	-2147483648 ... 2147483647	0x4043:016
	SUB 017: Set2: value 17	0	-2147483648 ... 2147483647	0x4043:017
	SUB 018: Set2: value 18	0	-2147483648 ... 2147483647	0x4043:018
	SUB 019: Set2: value 19	0	-2147483648 ... 2147483647	0x4043:019
	SUB 020: Set2: value 20	0	-2147483648 ... 2147483647	0x4043:020
	SUB 021: Set2: value 21	0	-2147483648 ... 2147483647	0x4043:021
	SUB 022: Set2: value 22	0	-2147483648 ... 2147483647	0x4043:022
	SUB 023: Set2: value 23	0	-2147483648 ... 2147483647	0x4043:023
	SUB 024: Set2: value 24	0	-2147483648 ... 2147483647	0x4043:024
	SUB 025: Set2: value 25	0	-2147483648 ... 2147483647	0x4043:025
	SUB 026: Set2: value 26	0	-2147483648 ... 2147483647	0x4043:026
	SUB 027: Set2: value 27	0	-2147483648 ... 2147483647	0x4043:027
	SUB 028: Set2: value 28	0	-2147483648 ... 2147483647	0x4043:028
	SUB 029: Set2: value 29	0	-2147483648 ... 2147483647	0x4043:029
	SUB 030: Set2: value 30	0	-2147483648 ... 2147483647	0x4043:030
	SUB 031: Set2: value 31	0	-2147483648 ... 2147483647	0x4043:031
SUB 032: Set2: value 32	0	-2147483648 ... 2147483647	0x4043:032	
PAR 753	<i>Param. set 3</i>			
	SUB 001: Set3: Value 1	0	-2147483648 ... 2147483647	0x4044:001
	SUB 002: Set3: value 2	0	-2147483648 ... 2147483647	0x4044:002
	SUB 003: Set3: value 3	0	-2147483648 ... 2147483647	0x4044:003
	SUB 004: Set3: value 4	0	-2147483648 ... 2147483647	0x4044:004
	SUB 005: Set3: value 5	0	-2147483648 ... 2147483647	0x4044:005
	SUB 006: Set3: value 6	0	-2147483648 ... 2147483647	0x4044:006
	SUB 007: Set3: value 7	0	-2147483648 ... 2147483647	0x4044:007
	SUB 008: Set3: value 8	0	-2147483648 ... 2147483647	0x4044:008
	SUB 009: Set3: value 9	0	-2147483648 ... 2147483647	0x4044:009
	SUB 010: Set3: value 10	0	-2147483648 ... 2147483647	0x4044:010
	SUB 011: Set3: value 11	0	-2147483648 ... 2147483647	0x4044:011
	SUB 012: Set3: value 12	0	-2147483648 ... 2147483647	0x4044:012
	SUB 013: Set3: value 13	0	-2147483648 ... 2147483647	0x4044:013
	SUB 014: Set3: value 14	0	-2147483648 ... 2147483647	0x4044:014
	SUB 015: Set3: value 15	0	-2147483648 ... 2147483647	0x4044:015
	SUB 016: Set3: value 16	0	-2147483648 ... 2147483647	0x4044:016
	SUB 017: Set3: value 17	0	-2147483648 ... 2147483647	0x4044:017
	SUB 018: Set3: value 18	0	-2147483648 ... 2147483647	0x4044:018
	SUB 019: Set3: value 19	0	-2147483648 ... 2147483647	0x4044:019
	SUB 020: Set3: value 20	0	-2147483648 ... 2147483647	0x4044:020
	SUB 021: Set3: value 21	0	-2147483648 ... 2147483647	0x4044:021
	SUB 022: Set3: value 22	0	-2147483648 ... 2147483647	0x4044:022
	SUB 023: Set3: value 23	0	-2147483648 ... 2147483647	0x4044:023
	SUB 024: Set3: value 24	0	-2147483648 ... 2147483647	0x4044:024
	SUB 025: Set3: value 25	0	-2147483648 ... 2147483647	0x4044:025
	SUB 026: Set3: value 26	0	-2147483648 ... 2147483647	0x4044:026
	SUB 027: Set3: value 27	0	-2147483648 ... 2147483647	0x4044:027
	SUB 028: Set3: value 28	0	-2147483648 ... 2147483647	0x4044:028
	SUB 029: Set3: value 29	0	-2147483648 ... 2147483647	0x4044:029
	SUB 030: Set3: value 30	0	-2147483648 ... 2147483647	0x4044:030
	SUB 031: Set3: value 31	0	-2147483648 ... 2147483647	0x4044:031
	SUB 032: Set3: value 32	0	-2147483648 ... 2147483647	0x4044:032
PAR 754	<i>Param. set 4</i>			
	SUB 001: Set4: Value 1	0	-2147483648 ... 2147483647	0x4045:001

* Default setting depending on the size.

Firmware-Version 01.01.01.00

Commissioning

Keypad parameter list



PAR	Name / SUB xxx: Name	Default setting	Setting range	Address
	SUB 002: Set4: value 2	0	-2147483648 ... 2147483647	0x4045:002
	SUB 003: Set4: value 3	0	-2147483648 ... 2147483647	0x4045:003
	SUB 004: Set4: value 4	0	-2147483648 ... 2147483647	0x4045:004
	SUB 005: Set4: value 5	0	-2147483648 ... 2147483647	0x4045:005
	SUB 006: Set4: value 6	0	-2147483648 ... 2147483647	0x4045:006
	SUB 007: Set4: value 7	0	-2147483648 ... 2147483647	0x4045:007
	SUB 008: Set4: value 8	0	-2147483648 ... 2147483647	0x4045:008
	SUB 009: Set4: value 9	0	-2147483648 ... 2147483647	0x4045:009
	SUB 010: Set4: value 10	0	-2147483648 ... 2147483647	0x4045:010
	SUB 011: Set4: value 11	0	-2147483648 ... 2147483647	0x4045:011
	SUB 012: Set4: value 12	0	-2147483648 ... 2147483647	0x4045:012
	SUB 013: Set4: value 13	0	-2147483648 ... 2147483647	0x4045:013
	SUB 014: Set4: value 14	0	-2147483648 ... 2147483647	0x4045:014
	SUB 015: Set4: value 15	0	-2147483648 ... 2147483647	0x4045:015
	SUB 016: Set4: value 16	0	-2147483648 ... 2147483647	0x4045:016
	SUB 017: Set4: value 17	0	-2147483648 ... 2147483647	0x4045:017
	SUB 018: Set4: value 18	0	-2147483648 ... 2147483647	0x4045:018
	SUB 019: Set4: value 19	0	-2147483648 ... 2147483647	0x4045:019
	SUB 020: Set4: value 20	0	-2147483648 ... 2147483647	0x4045:020
	SUB 021: Set4: value 21	0	-2147483648 ... 2147483647	0x4045:021
	SUB 022: Set4: value 22	0	-2147483648 ... 2147483647	0x4045:022
	SUB 023: Set4: value 23	0	-2147483648 ... 2147483647	0x4045:023
	SUB 024: Set4: value 24	0	-2147483648 ... 2147483647	0x4045:024
	SUB 025: Set4: value 25	0	-2147483648 ... 2147483647	0x4045:025
	SUB 026: Set4: value 26	0	-2147483648 ... 2147483647	0x4045:026
	SUB 027: Set4: value 27	0	-2147483648 ... 2147483647	0x4045:027
	SUB 028: Set4: value 28	0	-2147483648 ... 2147483647	0x4045:028
	SUB 029: Set4: value 29	0	-2147483648 ... 2147483647	0x4045:029
	SUB 030: Set4: value 30	0	-2147483648 ... 2147483647	0x4045:030
	SUB 031: Set4: value 31	0	-2147483648 ... 2147483647	0x4045:031
	SUB 032: Set4: value 32	0	-2147483648 ... 2147483647	0x4045:032
PAR 755	Param. set mode	Inhibit [0]	Selection list	0x4046
PAR 756	Param. set status			
	SUB 001: Param. set error	-	-(Read only)	0x4047:001
	SUB 002: ParSet error loc	-	-(Read only)	0x4047:002
PAR 760	Fault config.			
	SUB 002: Ctrl: start-up del	3.0 s	0.0 ... 1000.0 s	0x2839:002
	SUB 003: Ctrl: start-up counter	5	0 ... 255	0x2839:003
	SUB 004: Ctrl:dec.period	5.0 s	0.1 ... 3600.0 s	0x2839:004
	SUB 005: Ctrl: curr. counter	-	-(Read only)	0x2839:005
PAR 780	Statusword	-	-(Read only)	0x6041
PAR 781	Setp. speed vl	0 rpm	-32768 ... 32767 rpm	0x6042
PAR 782	Speed interpol	x rpm	-(Read only)	0x6043
PAR 783	Actual speed	x rpm	-(Read only)	0x6044
PAR 784	Min/max speed			
	SUB 001: VL min amount	0 rpm	0 ... 480000 rpm	0x6046:001
	SUB 002: VL max amount	480000 rpm	0 ... 480000 rpm	0x6046:002
PAR 785	Speed acc.			
	SUB 001: Delta speed	3000 rpm	0 ... 2147483647 rpm	0x6048:001
	SUB 002: Delta time	10 s	0 ... 65535 s	0x6048:002
PAR 786	Speed decel.			
	SUB 001: Delta speed	3000 rpm	0 ... 2147483647 rpm	0x6049:001
	SUB 002: Delta time	10 s	0 ... 65535 s	0x6049:002

* Default setting depending on the size.

Firmware-Version 01.01.01.00



Commissioning

Keypad parameter list

PAR	Name / SUB xxx: Name	Default setting	Setting range	Address
PAR 788	<i>Modes of op. dis</i>	-	- (Read only)	0x6061
PAR 789	<i>Supported modes</i>	-	- (Read only)	0x6502
PAR 790	<i>402quickst time</i>	546000 pos. unit / s ²	0 ... 2147483647 pos. unit / s ²	0x6085
PAR 791	<i>Resp. in the event of error</i>	Coasting [0]	Selection list	0x605E
* Default setting depending on the size.				Firmware-Version 01.01.01.00



5 Diagnostics and fault elimination

5.1 LED status displays

The "RDY" and "ERR" LED status displays on the front of the inverter provide some quick information about certain operating states.

"RDY" LED (blue)	"ERR" LED (red)	Status/meaning
off	off	No supply voltage.
blinking (1 Hz)	off	Safe torque off (STO) active.
	blinking fast (4 Hz)	Safe torque off (STO) active, warning active.
blinking (2 Hz)	off	Inverter inhibited.
	blinking fast (4 Hz)	Inverter inhibited, warning active.
	on	Inverter inhibited, fault active.
	lit every 1.5 s for a short time	Inverter inhibited, no DC-bus voltage.
	on for a short time every 1 s	Diagnostic module is connected, 5 V supply voltage for diagnostic module is available.
on	on	Initialisation (inverter is started) or quick stop active.
	off	Inverter enabled. The motor rotates according to the setpoint specified.
	blinking fast (4 Hz)	Inverter enabled, warning active. The motor rotates according to the setpoint specified.
	blinking (1 Hz)	Inverter enabled, quick stop as response to fault active.
66 ms off 125 ms on	66 ms on 125 ms off	Firmware update active.
Both LEDs are flickering synchronously		"Optical detection" function active.



5.2 Keypad fault display

If a fault is pending, the keypad shows the following information:

Keypad display	Meaning
	❶ Message text
	❷ Response
	W Warning
	T Trouble
	F Fault
	❸ Error code. ▶ Short overview of all error codes □ 63



5.3 Diagnostics

The inverter provides many diagnostic parameters which are helpful for operation, maintenance, error diagnosis, error correction, etc.

- In the following overview the most common diagnostic parameters are listed. For the keypad you can find these diagnostic parameters in group 1.
- Further parameters for more specific diagnostic purposes are described in the following subchapters.
- The diagnostic parameters can only be read and cannot be written to.

Parameter	Name / value range / [default setting]	Info
0x2030	CRC parameter set • Read only	Display of the checksum of the parameter set. • Each parameter set has an individual checksum (CRC32) that is created from the settings of all storable indices (P-flag) of the parameter set. If a setting changes, the checksum changes as well. • Cyclic redundancy check (CRC): By comparing the checksums of parameter sets, you can check whether the parameter sets are identical or not.
0x2B0E (PAR 102)	Frequency setpoint (Freq. setp. Hz) • Read only: x.x Hz	Display of the frequency setpoint currently assigned. • Depending on the present operating conditions, this value may differ from the current output frequency at the motor shaft.
0x2B0F	V/f operation: actual frequency of motor shaft • Read only: x.x Hz	Display of the current output frequency at the motor shaft.
0x2D4F (PAR 123)	Motor utilisation ($i^2 \cdot t$) (Mot. I2t utilis.) • Read only: x %	Display of the current thermal motor utilisation.
0x2D87 (PAR 105)	DC-bus voltage (DC bus) • Read only: x V	Display of the current DC-bus voltage.
0x2D88 (PAR 104)	Actual motor current (Act. motor current) • Read only: x.x A	Display des present current-r.m.s. value.
0x2D89 (PAR 106)	Actual motor voltage (Motor voltage) • Read only: x VAC	Display of the current motor voltage.
0x2DA2:001 (PAR 108/001)	Output power: Effective (Output power: Effective power) • Read only: x.xxx kW	Display of the active output power for an energy analysis in the respective application.
0x2DA2:002 (PAR 108/002)	Output power: Apparent power (Output power: Apparent power) • Read only: x.xxx kW	Display of the apparent output power for an energy analysis in the respective application.
0x2DA3:001 (PAR 109/001)	Output energy: Motor (Output energy: Motor output energy) • Read only: x.xx kWh	Display of the output power in motor mode for an energy analysis in the respective application.
0x2DA3:002 (PAR 109/002)	Output energy: Generator (Output energy: Gen. output energy) • Read only: x.xx kWh	Display of the output power in generator mode for an energy analysis in the respective application.
0x2DDD (PAR 100)	Actual frequency (Actual frequency) • Read only: x.x Hz	Display of the current field frequency for diagnostics of closed loop control.
0x400D (PAR 101)	Scaled actual value (Scaled actual value) • Read only: x Units	Display of the current speed in application units.
0x6077 (PAR 107)	Torque actual value (Actual torque %) • Read only: x.x %	Display of the current torque. • 100 % \equiv permissible maximum torque
0x6078 (PAR 103)	Current actual value (Motor current %) • Read only: x.x %	Display of the present motor current. • 100 % \equiv rated motor current 0x6075 (PAR 323)
0x2D84:001 (PAR 117/001)	Heatsink temperature monitoring: Actual value (Heatsink temp.: Heatsink temp.) • Read only: x.x °C	Display of the current heatsink temperature.



Parameter	Name / value range / [default setting]	Info
0x2D84:002	Heatsink temperature monitoring: Warning threshold 50.0 ... [80.0]* ... 100.0 °C <ul style="list-style-type: none"> • Default setting depending on the size. 	Warning threshold for temperature monitoring. <ul style="list-style-type: none"> • If the heatsink temperature exceeds the threshold set here, the inverter outputs a warning. • The warning is reset with a hysteresis of approx. 5 °C. • If the heatsink temperature increases further and exceeds the non-adjustable error threshold (100 °C), the inverter changes to the "Fault" device status. Further operation of the inverter is disabled by controller inhibit.

5.3.1 Logbook

For diagnostic purposes, the logbook contains the last 32 error messages and warning signals of the inverter, which have occurred during operation.

Preconditions

The logbook can only be accessed

- via the user interface of »EASY Starter« ("Diagnostics" tab) or
- via network.

Details

In contrast to the error history buffer, the logbook additionally protocols the following events:

- Fault messages
- Change-over from normal to setup mode (and vice versa)
- Execution of device commands
- Avoidance of safety functions

The logbook entries are saved persistently in the inverter. If all 32 memory units are occupied, the oldest entry is deleted for a new entry. By means of the "Delete logbook" device command, all logbook entries can be deleted.

Accessing the logbook with »EASY Starter«

1. Select the inverter on the left side in the »EASY Starter« device list.
2. Change to the "Diagnostics" tab.
3. Click the  icon to open the logbook.

Observe that the logbook only presents a snapshot at the time the data are read out. If a new event occurs, the logbook must be read out again so that the new event becomes visible.

Accessing the logbook via network

The logbook can also be accessed via network from a higher-level controller or a visualisation. The structure of the diagnostic messages complies with the "ETG.1020" standard of the EtherCAT Technology Group (ETG).



See chapter 13.3 of document "ETG.1020 Protocol Enhancements" provided by the EtherCAT Technology Group (ETG) for detailed information on the structure of the diagnostic messages.

Parameter	Name / value range / [default setting]	Info
0x2022:015 (PAR 700/015)	Device commands: Delete logbook (Device commands: Delete logbook) 0 ... [0] ... 1 <ul style="list-style-type: none"> • Setting can only be changed if controller inhibit is active. 	1 = delete all entries in the logbook.

Diagnostics and fault elimination

Diagnostics
Error history buffer



5.3.2 Error history buffer

For purposes of diagnostics, the error history buffer contains the last 32 error and warning messages of the inverter, which have occurred during operation. The error history buffer can be read out using the keypad via *PAR 155* and provides a limited view on the logbook.

Details

- For each event that is recorded, the error history buffer contains the message text, the error code, the time of occurrence as well as a counter for successive, identical events. If an event that has already been recorded occurs repeatedly, only the counter is incremented.
- The error history buffer can be reset by the user. In order to prevent the buffer from being reset by the user, this function can be protected by means of a password.
- Observe that the error history buffer only presents a snapshot at the time the data are read out. If a new event occurs, the error history buffer must be read out again via *PAR 155* so that the new event becomes visible.

Accessing the error history buffer with the keypad

1. Use the \leftarrow key in the operating mode to navigate to the parameterisation mode one level below.
You are now in the group level. All parameters of the inverter are divided into different groups according to their function.
Note: Use the \rightarrow key to navigate one level upwards again anytime.
2. Use the \uparrow navigation key to select group 1 ("Diagnostics").
3. Use the \leftarrow key to navigate to one level below.
You are now in the parameter level of the group selected.
4. Use the \uparrow and \downarrow navigation keys to select the *PAR 155* parameter.
5. Use the \leftarrow key to navigate to one level below.
You are now in the error history buffer.
6. With the \uparrow and \downarrow navigation keys you can now scroll through the fault memory entries.
By means of the \leftarrow key, you can switch over the display.

Information displayed (page 1):

- ❶ Message text
- ❷ Error memory entry (01 = most recent event)
- ❸ Response (W = warning, T = trouble, F = fault)
- ❹ Error code

Information displayed (page 2):

- ❺ Time of occurrence
- ❻ Error memory entry (01 = most recent event)
- ❼ Counter for successive, identical events

Note: By using the \rightarrow key you can exit the error history buffer again.

Parameter	Name / value range / [default setting]	Info
0x2006:000 (<i>PAR 155/000</i>)	Error history buffer: Keypad display (<i>Fault memory: Keypad display</i>) • Read only	Display of the error history buffer on the keypad.
0x2006:001	Error history buffer: Maximum number of messages • Read only	Display of the maximum number of messages which can be stored in the history buffer (from subindex 6).
0x2006:002	Error history buffer: Latest message • Read only	Display of the subindex of the most recent message.



Diagnostics and fault elimination

Diagnostics
Error history buffer

Parameter	Name / value range / [default setting]	Info
0x2006:003	Error history buffer: Latest acknowledgement message 0 ... [1] ... 1	0 = delete all entries in the error history buffer.
0x2006:004	Error history buffer: New message • Read only	Reserved for future extensions.
0x2006:005	Error history buffer: Buffer overflow • Read only	Bit 0 ... bit 4 = 0. Bit 5 = 1 \equiv overflow (after recording the 33th event in the error history buffer).
0x2006:006	Error history buffer: Message 0 • Read only	Error history buffer, contains information about each message for the display on the keypad.
0x2006:007	Error history buffer: Message 1 • Read only	
0x2006:008	Error history buffer: Message 2 • Read only	
0x2006:009	Error history buffer: Message 3 • Read only	
0x2006:010	Error history buffer: Message 4 • Read only	
0x2006:011	Error history buffer: Message 5 • Read only	
0x2006:012	Error history buffer: Message 6 • Read only	
0x2006:013	Error history buffer: Message 7 • Read only	
0x2006:014	Error history buffer: Message 8 • Read only	
0x2006:015	Error history buffer: Message 9 • Read only	
0x2006:016	Error history buffer: Message 10 • Read only	
0x2006:017	Error history buffer: Message 11 • Read only	
0x2006:018	Error history buffer: Message 12 • Read only	
0x2006:019	Error history buffer: Message 13 • Read only	
0x2006:020	Error history buffer: Message 14 • Read only	
0x2006:021	Error history buffer: Message 15 • Read only	
0x2006:022	Error history buffer: Message 16 • Read only	
0x2006:023	Error history buffer: Message 17 • Read only	
0x2006:024	Error history buffer: Message 18 • Read only	
0x2006:025	Error history buffer: Message 19 • Read only	
0x2006:026	Error history buffer: Message 20 • Read only	
0x2006:027	Error history buffer: Message 21 • Read only	
0x2006:028	Error history buffer: Message 22 • Read only	
0x2006:029	Error history buffer: Message 23 • Read only	
0x2006:030	Error history buffer: Message 24 • Read only	
0x2006:031	Error history buffer: Message 25 • Read only	

Diagnostics and fault elimination

Diagnostics
Inverter diagnostics



Parameter	Name / value range / [default setting]	Info
0x2006:032	Error history buffer: Message 26 • Read only	
0x2006:033	Error history buffer: Message 27 • Read only	
0x2006:034	Error history buffer: Message 28 • Read only	
0x2006:035	Error history buffer: Message 29 • Read only	
0x2006:036	Error history buffer: Message 30 • Read only	
0x2006:037	Error history buffer: Message 31 • Read only	

5.3.3 Inverter diagnostics

The following parameters supply some information about the current operating status of the inverter.

This includes the following information:

- Active access protection after log-in by means of PIN1/PIN2
- Currently loaded parameter settings
- Cause(s) of controller inhibit, quick stop and stop.
- Active control source and active setpoint source
- Active operating mode
- Keypad status
- Status of the internal motor control

Parameter	Name / value range / [default setting]	Info
0x2040 (PAR 197)	Access protection status (Protection status) • Read only	Display of the active access protection after log-in via PIN1/PIN2. • 0 = write access to all parameters possible. • 1 ≡ no write access. • 2 = write access only possible to parameters of group 0 (Favorites).
0x2827 (PAR 198)	Currently loaded parameter settings (Status of load. par) • Read only	Display of the parameter settings currently loaded.
	0 User settings	
	1 Reset 60 Hz setting	Delivery status (Lenze setting) for 50 Hz
	2 Reset 50 Hz setting	Delivery status (Lenze setting) for 60 Hz
	3 OEM default settings	
0x282A:001 (PAR 126/001)	Status words: Cause of controller inhibit (Status words: Cause of contr. inhibit) • Read only	Bit coded display of the cause(s) of controller inhibit.
	Bit 0 Flexible I/O configuration	1 ≡ controller inhibit was activated by the trigger set in 0x2631:001 (PAR 400/001) .
	Bit 1 Network	1 ≡ controller inhibit was activated via network.
	Bit 2 Axis command	1 ≡ controller inhibit was activated via axis command 0x2822:001 .
	Bit 3 Reserved	-
	Bit 4	
	Bit 5	
	Bit 6	
	Bit 7 Drive not ready	
	Bit 8 Reserved	-
	Bit 9 Motor parameter identification	1 ≡ controller inhibit was activated by the "Automatic motor parameter identification" function.
	Bit 10 Automatic holding brake control	1 ≡ controller inhibit was activated by the "Holding brake control" function.
	Bit 11 Reserved	-
	Bit 12 CiA402 controller inhibit	1 ≡ controller inhibit was activated by the internal state machine of the inverter.
Bit 13 CiA402 Quick stop option code 2	1 ≡ controller inhibit was activated by the "Quick stop" function.	



Diagnostics and fault elimination

Diagnostics
Inverter diagnostics

Parameter	Name / value range / [default setting]	Info	
	Bit 14	Safe torque off (STO)	1 ≡ controller inhibit was activated by the integrated safety system.
	Bit 15	CIA402 operation mode 0	1 ≡ controller inhibit was activated by selection of mode 0 ("No operating mode") in 0x6060 (PAR 301).
	Bit 16	Reserved	-
	Bit 17		
	Bit 18		
	Bit 19		
	Bit 20		
	Bit 21		
	Bit 22		
	Bit 23		
	Bit 24		
	Bit 25		
	Bit 26		
	Bit 27		
Bit 28			
Bit 29			
Bit 30			
Bit 31			
0x282A:002 (PAR 126/002)	Status words: Cause of quick stop (Status words: Cause of QSP) • Read only	Bit coded display of the cause(s) of quick stop.	
Bit 0	Flexible I/O configuration	1 ≡ quick stop was activated by the trigger set in 0x2631:003 (PAR 400/003).	
Bit 1	Network	1 ≡ quick stop was activated via network.	
Bit 2	Axis command	1 ≡ quick stop was activated via axis command 0x2822:001.	
Bit 3	Reserved	-	
Bit 4			
Bit 5			
Bit 6	Error response		
Bit 7	Reserved	-	
Bit 8			
Bit 9			
Bit 10			
Bit 11			
Bit 12			
Bit 13			
Bit 14			
Bit 15			
0x282A:003 (PAR 126/003)	Status words: Cause of stop (Status words: Cause of stop) • Read only	Bit coded display of the cause(s) of stop.	
Bit 0	Flexible I/O: No start enable	1 ≡ stop was activated by the trigger set in 0x2631:002 (PAR 400/002).	
Bit 1	Flexible I/O: Run CW		
Bit 2	Flexible I/O: Run CCW		
Bit 3	Flexible I/O: Preset CW		
Bit 4	Flexible I/O: Preset CCW		
Bit 5	Network	1 ≡ stop was activated via network.	
Bit 6	Keypad	1 ≡ stop was activated via keypad.	
Bit 7	Control transition	1 ≡ Stop was activated due to a change of the operating mode.	

Diagnostics and fault elimination

Diagnostics
Inverter diagnostics



Parameter	Name / value range / [default setting]	Info		
	Bit 8	Reserved		
	Bit 9			
	Bit 10			
	Bit 11			
	Bit 12			
	Bit 13			
	Bit 14			
	Bit 15	Waiting for start		
0x282A:004	Status words: Extended status word • Read only		Bit-coded status word.	
	Bit 0	Reserved		
	Bit 1			
	Bit 2			
	Bit 3			
	Bit 4			
	Bit 5			
	Bit 6			
	Bit 7			
	Bit 8	Reversal		1 ≡ reversal active.
	Bit 9	Reserved		1 ≡ quick stop due to fault active.
	Bit 10	Safe torque off (STO) active		1 ≡ "Safe torque off" function (STO) has been triggered by the integrated safety system.
	Bit 11	Reserved		
	Bit 12			
Bit 13				
Bit 14				
0x282A:005 (PAR 126/005)	Status words: Device status (Status words: Device status) • Read only		Display of the current inverter device state.	
	0	Initialisation		
	2	Not Ready to Switch On		
	3	Switch-on inhibited		
	4	Ready to Switch On		
	5	Switched on		
	6	Operation enabled		
	7	"Disable operation" command		
	8	"Shutdown" command		
	9	Quick stop active		
	10	Error response active		
	11	Error		
0x282B:001 (PAR 125/001)	Inverter diagnostics: Active control source (Inverter diag.: Active ctrl) • Read only		Display of the control source that is currently active.	
	0	Flexible I/O configuration		
	1	Network		
	2	Keypad		
	3	Internal		
	4			
	5			
	6			
7				
0x282B:002 (PAR 125/002)	Inverter diagnostics: Active setpoint source (Inverter diag.: Active setpoint) • Read only		Display of the setpoint source that is currently active.	
	0	Not selected		



Diagnostics and fault elimination

Diagnostics
Inverter diagnostics

Parameter	Name / value range / [default setting]	Info
	1 Analog input 1	
	2 Analog input 2	
	3 Keypad Setpoint	
	4 Digital frequency via Dlx	Frequency setpoint at digital input 1.
	5 Network Setpoint	
	11 Preset setpoint 1	Preset values 1 ... 15
	12 Preset setpoint 2	
	13 Preset setpoint 3	
	14 Preset setpoint 4	
	15 Preset setpoint 5	
	16 Preset setpoint 6	
	17 Preset setpoint 7	
	18 Preset setpoint 8	
	19 Preset setpoint 9	
	20 Preset setpoint 10	
	21 Preset setpoint 11	
	22 Preset setpoint 12	
	23 Preset setpoint 13	
	24 Preset setpoint 14	
	25 Preset setpoint 15	
	31 Preset segm. val. 1	"Sequencer" function
	32 Preset segm. val. 2	
	33 Preset segm. val. 3	
	34 Preset segm. val. 4	
	35 Preset segm. val. 5	
	36 Preset segm. val. 6	
	37 Preset segm. val. 7	
	38 Preset segm. val. 8	
	39 Last segment	
	50 Motor potentiometer	"Motor potentiometer" function
	99 Test setpoint	
0x282B:003 (PAR 125/003)	Inverter diagnostics: Keypad LCD status (<i>Inverter diag.: LCD icon status</i>) • Read only	Bit-coded state of the keypad status displays.
	Bit 0 LOC	1 ≙ local keypad control active.
	Bit 1 REM	1 ≙ remote control via terminals, network, etc. active.
	Bit 2 MAN	1 ≙ manual setpoint selection via keypad active.
	Bit 3 Auto	1 ≙ automatic setpoint selection via terminals, network, etc. active.
	Bit 4 Set	
	Bit 5 Reserved	-
	Bit 6	
Bit 7		
0x282B:004 (PAR 125/004)	Inverter diagnostics: Active drive mode (<i>Inverter diag.: Drive mode</i>) • Read only	Display of the active drive mode.
	0 Speed mode	Speed mode active.
	1 Process controller mode	Process controller mode active.
	3 Test mode (internal)	Test mode active.
	4 Jog operation	"Forward jog (CW)" or "Backward jog (CCW)" function active.
0x2831	Lenze status word • Read only	Bit-coded status word of the internal motor control.
	Bit 0 Reserved	-
	Bit 1 Speed 1 limited	1 ≙ input of speed controller 1 in limitation.
	Bit 2 Speed limited	1 ≙ output of speed controller 1 in limitation.
	Bit 3 Torque limited	1 ≙ setpoint torque in limitation.
	Bit 4 Current limited	1 ≙ setpoint current in limitation.

Diagnostics and fault elimination

Diagnostics
Inverter diagnostics



Parameter	Name / value range / [default setting]	Info	
	Bit 5	Speed 2 limited	1 ≡ input of speed controller 2 in torque mode in limitation.
	Bit 6	Upper speed limit active	1 ≡ speed is limited to upper speed limit in torque mode .
	Bit 7	Lower speed limit active	1 ≡ speed is limited to lower speed limit in torque mode .
	Bit 8	Reserved	-
	Bit 9		
	Bit 10	Output frequency limited	1 ≡ setpoint frequency with V/f operation in limitation.
	Bit 11	Magnetisation completed	1 ≡ during V/f operation, the factor 7 rotor time constant has passed (calculated from the time at which the inverter was enabled without restart on the fly and with a total motor current of 20 % rated motor current for the first time). Otherwise 0.
	Bit 12	Motor phase error	1 ≡ motor phase failure detection active.
	Bit 13	Reserved	-
	Bit 14	Blocking time for error reset is active	1 ≡ the fault can only be reset when the blocking time has elapsed.
	Bit 15	Reserved	-
0x2833	Lenze status word 2 • Read only		Bit-coded Lenze status word.
	Bit 0	Reserved	-
	Bit 1	Manual test mode active	1 ≡ manual test mode active.
	Bit 2	Manual control active	1 ≡ manual control active.
	Bit 3	Reserved	-
	Bit 4		
	Bit 5		
	Bit 6	DC braking active	1 ≡ DC braking active.
	Bit 7	Reserved	-
	Bit 8		
	Bit 9		
	Bit 10		
	Bit 11		
	Bit 12		
	Bit 13		
Bit 14			
Bit 15			
0x2DAC (PAR 119)	Keypad status (Keypad status) • Read only		Bit-coded display of the keypad status.
	Bit 0	Start Key	1 ≡ keypad key activated.
	Bit 1	Stop Key	
	Bit 2	Up arrow	
	Bit 3	Down arrow	
	Bit 4	Enter Key	
	Bit 5	Back key	
	Bit 6	Reserved	-
	Bit 7		
	Bit 8		
	Bit 9		
	Bit 10		
	Bit 11		
	Bit 12		
	Bit 13		
Bit 14			
Bit 15			
0x2DAD (PAR 120)	Internal hardware states (Int. HW states) • Read only		Bit-coded display of internal hardware states.
	Bit 0	Relay	0 ≡ X9/NO-COM open and NC-COM closed. 1 ≡ X9/NO-COM closed and NC-COM open.



Diagnostics and fault elimination

Diagnostics
Network diagnostics

Parameter	Name / value range / [default setting]	Info		
	Bit 1	Digital output 1	0 ≡ LOW level, 1 ≡ HIGH level.	
	Bit 2	Digital output 2		
	Bit 3	Reserved		
	Bit 4			
	Bit 5			
	Bit 6			
	Bit 7			
	Bit 8			
	Bit 9			
	Bit 10	Charge Relay		
	Bit 11	Reserved		-
	Bit 12			
	Bit 13			
	Bit 14			
	Bit 15			
0x603F (PAR 150)	Error code (Active error) • Read only	Error message		

5.3.4 Network diagnostics

The following parameters show some general information with regard to the network option available and the network.

Further fieldbus-specific diagnostic parameters are described in the following subchapters.

Parameter	Name / value range / [default setting]	Info
0x282B:005 (PAR 125/005)	Inverter diagnostics: Most recently used control register (Inverter diag.: Netw. contr.reg.) • Read only	Display of the network register for the control that was accessed last (e. g. 0x6040 or 0x400B:1). • Format: 0xiiii:ss00 (iiii = hexadecimal index, ss = hexadecimal subindex) • The lowest byte is always 0x00.
0x282B:006 (PAR 125/006)	Inverter diagnostics: Most recently used setpoint register (Inverter diag.: Netw. setp.reg.) • Read only	Display of the network register for setpoint selection that was accessed last (e. g. 0x6042 or 0x400B:3). • Format: 0xiiii:ss00 (iiii = hexadecimal index, ss = hexadecimal subindex) • The lowest byte is always 0x00.
0x400B:006 (PAR 592/006)	Predefined process input data: Network speed setpoint (Legacy NetWordIN: Netw. speed setp.) -599.0 ... [0.0] ... 599.0 Hz	Display of the setpoint received via network for speed mode.
0x400B:007 (PAR 592/007)	Predefined process input data: Network process controller setpoint (Legacy NetWordIN: Netw. PID setp.) -300.00 ... [0.00] ... 300.00 PUnit	Display of the setpoint received via network for process controller mode.
0x400B:008 (PAR 592/008)	Predefined process input data: Network torque setpoint (Legacy NetWordIN: Netw. torque setp.) -32768 ... [0] ... 32767 Nm	Display of the setpoint received via network for torque mode.
0x231F:001 (PAR 500/001)	Module ID: Active module ID (Module ID: Active module ID) • Read only • Default setting depending on the size.	Display of the network options currently configured in the inverter. • When the "Load Lenze settings" device command 0x2022:001 (PAR 700/001) or "Accept new inverter hardware" 0x2022:027 (PAR 700/027) is executed, the module ID is stored in the memory module. • With the help of this module ID, the keypad only shows the communication parameters relevant to the respective network.
	0	No network
	67	CANopen
	80	PROFIBUS
	87	Modbus

Diagnostics and fault elimination

Diagnostics
Network diagnostics



Parameter	Name / value range / [default setting]	Info
0x231F:002 (PAR 500/002)	Module ID: Module ID connected (Module ID: Module ID conn.) • Read only	Display of the network options currently connected in the inverter.
	0 No network	
	67 CANopen	
	80 PROFIBUS	
	87 Modbus	

Related topics

► [Configuring the network](#) 96

5.3.4.1 CANopen diagnostics

The following parameters serve to diagnose the CANopen interface and communication via CANopen.

Preconditions

Control unit (CU) of the inverter is provided with CANopen.

Parameter	Name / value range / [default setting]	Info
0x1000	Device type • Read only	CANopen device profile in compliance with CiA301/CiA402 CANopen specification. Specifies the axis type: <ul style="list-style-type: none"> • 0x01010192 ≡ single axis • 0x02010192 ≡ double axis • 0x01020192 ≡ servo single axis • 0x02020192 ≡ servo double axis • 0x01030192 ≡ stepper single axis • 0x02030192 ≡ stepper double axis
0x1001	Error register • Read only	Bit-coded error status. • The inverter only outputs a generic error (bit 0 = 1).
0x1008	Manufacturer's device name • Read only	Manufacturer's device name
0x1009	Manufacturer hardware version • Read only	Manufacturer hardware version
0x100A	Manufacturer software version • Read only	Manufacturer software version
0x1018:001	Identity object: Supplier ID • Read only	Manufacturer's identification number • The identification number allocated to Lenze by the organisation "CAN in Automation e. V." is "0x0000003B".
0x1018:002	Identity object: Product code • Read only	Product code of the inverter.
0x1018:003	Identity object: Revision • Read only	Main and subversion of firmware.
0x1018:004	Identity object: Serial number • Read only	Serial number of the inverter.
0x2302:001 (PAR 511/001)	Active CANopen settings: Node ID (CANopen status: Node ID) • Read only	Display of the active node address.
0x2302:002 (PAR 511/002)	Active CANopen settings: Baud rate (CANopen status: Baud rate) • Read only	Display of the active baud rate.
	0 Automatic	
	1 20 kbps	
	2 50 kbps	
	3 125 kbps	
	4 250 kbps	
	5 500 kbps	
	6 800 kbps	
7 1 Mbps		



Diagnostics and fault elimination

Diagnostics
Network diagnostics

Parameter	Name / value range / [default setting]	Info
0x2307 (PAR 515)	CANopen time-out status (Time-out status) • Read only	Bit-coded status display of the CAN time monitoring functions.
	Bit 0 RPDO1-Timeout	1 ≙ RPDO1 was not received within the monitoring time or not with the sync configured. • Status is reset automatically after the RPDO has been received again. • Setting of monitoring time for RPDO1 in 0x1400:005 (PAR 540/005).
	Bit 1 RPDO2-Timeout	1 ≙ RPDO2 was not received within the monitoring time or not with the sync configured. • Status is reset automatically after the RPDO has been received again. • Setting of monitoring time for RPDO2 in 0x1401:005 (PAR 541/005).
	Bit 2 RPDO3-Timeout	1 ≙ RPDO3 was not received within the monitoring time or not with the sync configured. • Status is reset automatically after the RPDO has been received again. • Setting of monitoring time for RPDO3 in 0x1402:005 (PAR 542/005).
	Bit 3 Reserved	-
	Bit 4	
	Bit 5	
	Bit 6	
	Bit 7	
	Bit 8 Heartbeat-Timeout Consumer 1	1 ≙ within the "Heartbeat Consumer Time", no heartbeat telegram was received from node 1 to be monitored. • Status can only be reset by mains switching. • "Heartbeat Consumer Time" setting in 0x1016:001 (PAR 520/001).
	Bit 9 Heartbeat-Timeout Consumer 2	1 ≙ within the "Heartbeat Consumer Time", no heartbeat telegram was received from node 2 to be monitored. • Status can only be reset by mains switching. • "Heartbeat Consumer Time" setting in 0x1016:002 (PAR 520/002).
	Bit 10 Heartbeat-Timeout Consumer 3	1 ≙ within the "Heartbeat Consumer Time", no heartbeat telegram was received from node 3 to be monitored. • Status can only be reset by mains switching. • "Heartbeat Consumer Time" setting in 0x1016:003 (PAR 520/003).
	Bit 11 Heartbeat-Timeout Consumer 4	1 ≙ within the "Heartbeat Consumer Time", no heartbeat telegram was received from node 4 to be monitored. • Status can only be reset by mains switching. • "Heartbeat Consumer Time" setting in 0x1016:004 (PAR 520/004).
	Bit 12 Reserved	-
	Bit 13	
	Bit 14	
	Bit 15	
	Bit 16	
	Bit 17	
	Bit 18	
Bit 19		
Bit 20		
Bit 21		
Bit 22		
Bit 23		
Bit 24		
Bit 25		
Bit 26		
Bit 27		
Bit 28		
Bit 29		
Bit 30		
Bit 31		

Diagnostics and fault elimination

Diagnostics
Network diagnostics



Parameter	Name / value range / [default setting]	Info
0x2308 (PAR 516)	CANopen status (CANopen status) • Read only	Display of the current CAN bus state.
	0 Initialisation	CAN bus initialisation active. • The initialisation is started automatically at mains connection. During this phase, the inverter is not involved in the data exchange process on the CAN bus. • The standard values are re-written to all CAN-relevant parameters. • When the initialisation process has been completed, the inverter automatically adopts the "Pre-Operational" state.
	1 Reset node	"Reset Node" NMT command active. • Initialisation of all CAN-relevant parameters with the values stored.
	2 Reset communication	"Reset Communication" NMT command active. • Initialisation of all CAN-relevant parameters with the values stored.
	4 Stopped	Only network management telegrams can be received.
	5 Operational	Parameter data and process data can be received.
	127 Pre-Operational	Parameter data can be received, process data are ignored.
0x2309 (PAR 517)	CANopen controller status (Controller status) • Read only	Status display of the internal CANopen controller.
	1 Error active	The inverter is a fully-fledged communication node at the CANopen network. It is able to transmit and receive data and to report faults.
	2 Error passive	The inverter can only passively indicate faulty reception via the ACK field.
	3 Bus off	The inverter is electrically separated from the CANopen network. In order to exit this state, the CANopen interface must be reset.
0x230A:001 (PAR 580/001)	CANopen statistics: PDO1 received (CAN counter: PDO1 received) • Read only	Display of the number of PDO1 telegrams received.
0x230A:002 (PAR 580/002)	CANopen statistics: PDO2 received (CAN counter: PDO2 received) • Read only	Display of the number of PDO2 telegrams received.
0x230A:003 (PAR 580/003)	CANopen statistics: PDO3 received (CAN counter: PDO3 received) • Read only	Display of the number of PDO3 telegrams received.
0x230A:005 (PAR 580/005)	CANopen statistics: PDO1 transmitted (CAN counter: PDO1 transmitted) • Read only	Display of the number of PDO1 telegrams sent.
0x230A:006 (PAR 580/006)	CANopen statistics: PDO2 transmitted (CAN counter: PDO2 transmitted) • Read only	Display of the number of PDO2 telegrams sent.
0x230A:007 (PAR 580/007)	CANopen statistics: PDO3 transmitted (CAN counter: PDO3 transmitted) • Read only	Display of the number of PDO3 telegrams sent.
0x230A:009 (PAR 580/009)	CANopen statistics: SDO1 telegrams (CAN counter: SDO1 counter) • Read only	Display of the number of SDO1 telegrams.
0x230A:010 (PAR 580/010)	CANopen statistics: SDO2 telegrams (CAN counter: SDO2 counter) • Read only	Display of the number of SDO2 telegrams.
0x230B (PAR 518)	CANopen error counter (CAN error counter) • Read only	Display of the total number of CAN faults that have occurred.

Related topics

▶ [CANopen](#)  112



5.3.4.2 Modbus diagnostics

The following parameters serve to diagnose the Modbus interface and communication via Modbus.

Preconditions

Control unit (CU) of the inverter is provided with Modbus.

Parameter	Name / value range / [default setting]	Info
0x2322:001 (PAR 511/001)	Active Modbus settings: Node ID (Active sett.: Node ID) • Read only	Display of the active node address.
0x2322:002 (PAR 511/002)	Active Modbus settings: Baud rate (Active sett.: Baud rate) • Read only	Display of the active baud rate.
0x2322:003 (PAR 511/003)	Active Modbus settings: Data format (Active sett.: Data format) • Read only	Display of the active data format.
0x232A:001 (PAR 580/001)	Modbus statistics: Messages received (Modbus counter: Messages received) • Read only	Display of the total number of messages received. • This counter counts both valid and invalid messages. • After the maximum value has been reached, the counter starts again "0".
0x232A:002 (PAR 580/002)	Modbus statistics: Valid messages received (Modbus counter: Val. mess. rec.) • Read only	Display of the number of valid messages received. • After the maximum value has been reached, the counter starts again "0".
0x232A:003 (PAR 580/003)	Modbus statistics: Messages with exceptions (Modbus counter: Mess. w. exc.) • Read only	Display of the number of messages with exceptions that have been received. • After the maximum value has been reached, the counter starts again "0".
0x232A:004 (PAR 580/004)	Modbus statistics: Messages with errors (Modbus counter: Mess. with errors) • Read only	Display of the number of messages received with a faulty data integrity (parity, CRC). • After the maximum value has been reached, the counter starts again "0".
0x232A:005 (PAR 580/005)	Modbus statistics: Messages sent (Modbus counter: Messages sent) • Read only	Display of the total number of messages sent. • After the maximum value has been reached, the counter starts again "0".

Related topics

► [Modbus](#) 127

5.3.5 Diagnostics of the inputs and outputs

5.3.5.1 Digital inputs and outputs

The following parameters serve to diagnose the digital inputs and outputs of the inverter.

Parameter	Name / value range / [default setting]	Info
0x60FD (PAR 118)	Digital inputs (Dig.inp. status) • Read only	Bit coded display of the current state of the digital inputs
	Bit 0 Reserved	-
	Bit 1	
	Bit 2	
	Bit 3	
	Bit 4	
	Bit 5	
	Bit 6	
	Bit 7	
	Bit 8	
	Bit 9	
	Bit 10	
	Bit 11	
	Bit 12	
	Bit 13	

Diagnostics and fault elimination

Diagnostics

Diagnostics of the inputs and outputs



Parameter	Name / value range / [default setting]	Info		
	Bit 14	0 ≡ LOW level, 1 ≡ HIGH level.		
	Bit 15			
	Bit 16		Level of digital input 1	
	Bit 17		Level of digital input 2	
	Bit 18		Level of digital input 3	
	Bit 19		Level of digital input 4	
	Bit 20		Level of digital input 5	
	Bit 21		Level of digital input 6	
	Bit 22		Level of digital input 7	
	Bit 23		Reserved	
	Bit 24			
	Bit 25		Internal interconnection of digital inputs	0 ≡ digital input terminals are set to HIGH level via pull-up resistors. 1 ≡ digital input terminals are set to LOW level via pull-down resistors.
	Bit 26		Reserved	
	Bit 27			
Bit 28				
Bit 29				
Bit 30				
Bit 31				
0x4016:005	Digital output 1: Terminal state • Read only 0 FALSE 1 TRUE	Display of the logic state of output terminal X3/DO1.		
0x4016:006	Digital output 1: Trigger signal state • Read only 0 FALSE 1 TRUE	Display of the logic state of the trigger signal for digital output 1 (without taking a ON/OFF delay set and inversion into consideration).		
0x4018:005	Relay: Relay state • Read only 0 FALSE 1 TRUE	Display of the logic state of the relay.		
0x4018:006	Relay: Trigger signal state • Read only 0 FALSE 1 TRUE	Display of the logic state of the trigger signal for the relay (without taking a ON/OFF delay set and inversion into consideration).		

Related topics

▶ [Configuration of digital inputs](#) 210

▶ [Configuration of digital outputs](#) 215

5.3.5.2 Analog inputs and outputs

The following parameters serve to diagnose the analog inputs and outputs of the inverter.

Parameter	Name / value range / [default setting]	Info
0x2DA4:001 (PAR 110/001)	Diagnostics of analog input 1: Value in percent (AI1 diagnostics: AI1 terminal %) • Read only: x.x %	Display of the current input value at X3/AI1 scaled as value in percent. • 100 % ≡ 10 V or 20 mA or 5 V
0x2DA4:002 (PAR 110/002)	Diagnostics of analog input 1: Frequency value (AI1 diagnostics: AI1 scaled freq.) • Read only: x.x Hz	Display of the current input value at X3/AI1 scaled as a frequency value. • The setpoint source for speed mode is selected in 0x2860:001 (PAR 201/001).
0x2DA4:003 (PAR 110/003)	Diagnostics of analog input 1: Process controller value (AI1 diagnostics: AI1 scaled PID) • Read only: x.xx PUnit	Display of the current input value at X3/AI1 scaled as a process controller value. • The setpoint source for process controller mode is selected in 0x2860:002 (PAR 201/002).
0x2DA4:004 (PAR 110/004)	Diagnostics of analog input 1: Torque value (AI1 diagnostics: AI1 scaled torque) • Read only: x.xx %	Display of the current input value at X3/AI1 scaled as a percentage torque value. • 100 % ≡ permissible maximum torque



Diagnostics and fault elimination

Diagnostics
Diagnostics of the inputs and outputs

Parameter	Name / value range / [default setting]	Info
0x2DA4:016 (PAR 110/016)	Diagnostics of analog input 1: Status (AI1 diagnostics: AI1 status) • Read only	Bit-coded display of the status of analog input 1 (X3/AI1).
	Bit 0 Mode 0: 0 ... 10 VDC active	
	Bit 1 Mode 1: 0 ... 5 VDC active	
	Bit 2 Mode 2: 2 ... 10 VDC active	
	Bit 3 Mode 3: -10 ... 10 VDC active	
	Bit 4 Mode 4: 4 ... 20 mA active	
	Bit 5 Mode 5: 0 ... 20 mA active	
	Bit 6 24 V supply OK	
	Bit 7 Calibration successful	
	Bit 8 Monitoring threshold exceeded/not reached	
	Bit 9 Input current too low (mode 4)	
	Bit 10 Input voltage too low (mode 2)	
	Bit 11 Input voltage too high (mode 4)	
	Bit 12 Reserved	
Bit 13		
Bit 14		
Bit 15		
0x2DA5:001 (PAR 111/001)	Diagnostics of analog input 2: Value in percent (AI2 diagnostics: AI2 terminal %) • Read only: x.x %	Display of the current input value at X3/AI2 scaled as a value in percent. • 100 % \equiv 10 V or 20 mA or 5 V
0x2DA5:002 (PAR 111/002)	Diagnostics of analog input 2: Frequency value (AI2 diagnostics: AI2 scaled freq.) • Read only: x.x Hz	Display of the current input value at X3/AI2 scaled as a frequency value. • The setpoint source for speed mode is selected in 0x2860:001 (PAR 201/001) .
0x2DA5:003 (PAR 111/003)	Diagnostics of analog input 2: Process controller value (AI2 diagnostics: AI2 scaled PID) • Read only: x.xx PUnit	Display of the current input value at X3/AI2 scaled as a process controller value. • The setpoint source for process controller mode is selected in 0x2860:002 (PAR 201/002) .
0x2DA5:004 (PAR 111/004)	Diagnostics of analog input 2: Torque value (AI2 diagnostics: AI2 scaled torque) • Read only: x.xx %	Display of the current input value at X3/AI2 scaled as a percentage torque value. • 100 % \equiv permissible maximum torque
0x2DA5:016 (PAR 111/016)	Diagnostics of analog input 2: Status (AI2 diagnostics: AI2 status) • Read only	Bit-coded display of the status of analog input 2 (X3/AI2).
	Bit 0 Mode 0: 0 ... 10 VDC active	
	Bit 1 Mode 1: 0 ... 5 VDC active	
	Bit 2 Mode 2: 2 ... 10 VDC active	
	Bit 3 Mode 3: -10 ... 10 VDC active	
	Bit 4 Mode 4: 4 ... 20 mA active	
	Bit 5 Mode 5: 0 ... 20 mA active	
	Bit 6 24 V supply OK	
	Bit 7 Calibration successful	
	Bit 8 Monitoring threshold exceeded/not reached	
	Bit 9 Input current too low	
	Bit 10 Input voltage too low	
	Bit 11 Input voltage too high	
	Bit 12 Reserved	
Bit 13		
Bit 14		
Bit 15		
0x2DAA:001 (PAR 112/001)	Diagnostics of analog output 1: Voltage (AO1 value: Analog outp.1 volt.) • Read only: x.xx V	Display of the current output voltage at X3/AO1.
0x2DAA:002 (PAR 112/002)	Diagnostics of analog output 1: Current (AO1 value: Analog outp.1 current) • Read only: x.xx mA	Display of the present output current at X3/AO1.

Diagnostics and fault elimination

Diagnostics
Process controller status



Related topics

- ▶ [Configuration of analog inputs](#) 121
- ▶ [Configuration of analog outputs](#) 122

5.3.6 Process controller status

The following parameters serve to diagnose the process controller.

Parameter	Name / value range / [default setting]	Info
0x401F:001 (PAR 121/001)	Process controller diagnostics: Current setpoint (PID diagnostics: Curr. PID setp.) • Read only: x.xx PUnit	Display of the current reference value (setpoint) for the process controller.
0x401F:002 (PAR 121/002)	Process controller diagnostics: Current feedback (PID diagnostics: Curr. PID feedb.) • Read only: x.xx PUnit	Display of the current controlled variable (actual value) fed back for the process controller.
0x401F:003 (PAR 121/003)	Process controller diagnostics: Status (PID diagnostics: PID status) • Read only	Bit-coded status display of the process controller.
	Bit 0 Process controller off	
	Bit 1 Process controller output set to 0	
	Bit 2 Process controller I-component set to 0	
	Bit 3 Process controller influence is shown via ramp	
	Bit 4 Setpoint = actual value	
	Bit 5 Idle state active	
	Bit 6 Reserved	
Bit 7		

Related topics

- ▶ [Configuring the process controller](#) 138

5.3.7 Device identification

The following parameters show some general information about the inverter.

Parameter	Name / value range / [default setting]	Info
0x2000:001 (PAR 190/001)	Product code (Product code) • Read only	Example: "I55AE155D10V10017S"
0x2000:002 (PAR 190/002)	Serial number (Serial number) • Read only	Example: "0000000000000000XYXYZ"
0x2000:004 (PAR 190/004)	Control unit - firmware version (CU firmware ver.) • Read only	Example: "01.00.01.00"
0x2000:005 (PAR 190/005)	Control unit - firmware type (CU firmware type) • Read only	Example: "IOFW51AC10"
0x2000:006 (PAR 190/006)	Control unit - bootloader version (CU bootlder ver.) • Read only	Example: "00.00.00.13"
0x2000:007 (PAR 190/007)	Control unit - bootloader type (CU bootlder type) • Read only	Example: "IOBL51AOnn"
0x2000:008 (PAR 190/008)	Object directory version (OBD version) • Read only	Example: 108478
0x2000:010 (PAR 190/010)	Power unit - firmware version (PU firmware ver.) • Read only	
0x2000:011 (PAR 190/011)	Power unit - firmware type (PU firmware type) • Read only	



Parameter	Name / value range / [default setting]	Info
0x2000:012 (PAR 190/012)	Power unit - bootloader version (<i>PU bootldr ver.</i>) • Read only	
0x2000:013 (PAR 190/013)	Power unit - bootloader type (<i>PU bootldr type</i>) • Read only	
0x2001 (PAR 191)	Device name (<i>Device name</i>) ["My Device"]	Any device name (e.g. "Wheel drive") can be set in this object for the purpose of device identification.

5.3.8 Device overload monitoring (i*t)

The inverter calculates the i*t utilisation in order to protect itself against thermal overload. In simple terms: a higher current or an overcurrent that continues for a longer time causes a higher i*t utilisation.

⚠ DANGER!

Uncontrolled motor movements by pulse inhibit.

When the device overload monitoring function is activated, pulse inhibit is set and the motor becomes torqueless. A load that is connected to motors without a holding brake may therefore cause uncontrolled movements! Without a load, the motor will coast.

► Only operate the inverter under permissible load conditions.

Details

The device overload monitoring function primarily offers protection to the power section. Indirectly, also other components such as filter chokes, circuit-board conductors, and terminals are protected against overheating. Short-time overload currents followed by recovery periods (times of smaller current utilisation) are permissible. The monitoring function during operation checks whether these conditions are met, taking into consideration that higher switching frequencies and lower stator frequencies as well as higher DC voltages cause a greater device utilisation.

- If the device utilisation exceeds the warning threshold set in [0x2D40:002](#) (Lenze setting: 95 %), the inverter outputs a warning. The user can utilise this status as a trigger to activate specific functions.
- If the device utilisation exceeds the fixed error threshold 100 %, the inverter changes to the "Trouble" device state. Further operation of the inverter is prevented by controller inhibit. Controlled standstill can only be executed by the use of a mechanical brake.

Device overload monitoring enables operation of the inverter under the following load conditions:

- Continuous current load with up to 100 % rated current.
- 3-minute cycle: 150 % rated current for 60 s, recovery phase 120 s with 75 % rated current.
- 15-second cycle: 200 % rated current for 3 s, recovery phase 12 s with 75 % rated current.

Parameter	Name / value range / [default setting]	Info
0x2D40:002	Device utilisation (i*t): Warning threshold 0 ... [95] ... 101 %	If the device utilisation exceeds the threshold set, the inverter outputs a warning. • With the setting 0 % or 101 %, the warning is deactivated.
0x2D40:004 (PAR 135/004)	Device utilisation (i*t): Actual utilisation (<i>Device utilisation: Ixt utilisation</i>) • Read only: x %	Display of the current device utilisation.
0x2D40:005 (PAR 135/005)	Device utilisation (i*t): Error response (<i>Device utilisation: Error response</i>)	Selection of the response to be executed when the device overload monitoring function is triggered.
	2 Trouble	
	3 Error	
0x2DDF:001	Axis information: Rated current • Read only: x.xx A • Default setting depending on the size.	

Diagnostics and fault elimination

Diagnostics

Heatsink Temperature Monitoring



5.3.9 Heatsink Temperature Monitoring

Parameter	Name / value range / [default setting]	Info
0x2D84:001 (PAR 117/001)	Heatsink temperature monitoring: Actual value (Heatsink temp.: Heatsink temp.) • Read only: x.x °C	Display of the current heatsink temperature.
0x2D84:002	Heatsink temperature monitoring: Warning threshold 50.0 ... [80.0]* ... 100.0 °C • Default setting depending on the size.	Warning threshold for temperature monitoring. • If the heatsink temperature exceeds the threshold set here, the inverter outputs a warning. • The warning is reset with a hysteresis of approx. 5 °C. • If the heatsink temperature increases further and exceeds the non-adjustable error threshold (100 °C), the inverter changes to the "Fault" device status. Further operation of the inverter is disabled by controller inhibit.

5.3.10 Diagnostics timer

The following parameters provide some information about the use of the inverter.

This includes the following information:

- Operating and power-on time of the inverter/control unit
- Operating time of the internal fan
- Number of switching cycles of the mains voltage
- Number of switching cycles of the relay
- Number of short-circuits and earth faults that have occurred
- Display of the number of "Clamp responds too often" errors that have occurred.

Parameter	Name / value range / [default setting]	Info
0x2D81:001 (PAR 151/001)	Service life timer: Operating time (Timer/counter: Operating time) • Read only: x s	Display showing for how long the inverter has been running so far "Operation enabled" device state.
0x2D81:002 (PAR 151/002)		Display showing for how long the inverter has been switched on so far.
0x2D81:003 (PAR 151/003)	Service life timer: Control unit operating time (Timer/counter: CU oper. time) • Read only: x ns	Display showing how long the control unit of the inverter has been switched on for so far. • This also includes the time within which the control unit has only been supplied with an external 24 V voltage.
0x2D81:004 (PAR 151/004)	Service life timer: Main Switching Cycles (Timer/counter: Power cycles) • Read only	Display of the number of switching cycles of the mains voltage.
0x2D81:005 (PAR 151/005)	Service life timer: Relay switching cycles (Timer/counter: Relay cycles) • Read only	Display of the number of switching cycles of the relay.
0x2D81:006 (PAR 151/006)	Service life timer: Short-circuit counter (Timer/counter: Short-circ. counter) • Read only	Display of the number of short circuits that have occurred.
0x2D81:007 (PAR 151/007)	Service life timer: Earth fault counter (Timer/counter: Earth fault counter) • Read only	Display of the number of earth faults that have occurred.
0x2D81:008 (PAR 151/008)	Service life timer: Clamp active (Timer/counter: Clamp active) • Read only	Display of the number of "Clamp responds too often" errors that have occurred. • "Clamp" = short-time inhibit of the inverter in V/f operation when the current limit shown in 0x2DDF:002 is reached.
0x2D81:009 (PAR 151/009)	Service life timer: Fan operating time (Timer/counter: Fan oper. time) • Read only: x s	Display showing for how long the internal fan has been running so far.



5.4 Short overview of all error codes

Error code	Type	Adjustable in	Keypad display	Info
0x2310	Fault	-	OC power mod.	CiA: continuous overcurrent (inside the device)
0x2320	Fault	-	Earth fault error	CiA: short circuit/earth fault (inside the device)
0x2340	Fault	-	OC short circuit	CiA: short circuit (inside the device)
0x2350	Fault	-	OL i2t motor	CiA: i ² *t overload (thermal state)
0x2382	Error	0x2D40:005 (PAR 135/005)	ixt error	I*t error
0x2383	Warning	-	ixt warning	I*t warning
0x2387	Fault	-	OC11 error	Clamp responds too often
0x3120	Fault	-	Su02 error	Single phase failure
0x3210	Fault	-	Overvolt. error	DC bus overvoltage
0x3211	Warning	-	W.OV DC bus	DC bus overvoltage warning
0x3220	Trouble	-	Undervolt. error	DC bus undervoltage
0x3221	Warning	-	W.UV DC bus	DC bus undervoltage warning
0x3222	Warning	-	W. switch-on voltage	DC-bus voltage too low for switch-on
0x4210	Fault	-	Overtemp.error1	Overtemp. error power mod.
0x4280	Fault	-	Heatsink sens.	Thermal sensor heatsink error
0x4281	Warning	-	Heats. fan error	Heatsink fan error
0x4285	Warning	-	W.OT1	Power module overtemperature warning
0x4310	Error	0x2D49:002 (PAR 309/002)	OT motor	Motor temperature has reached error threshold
0x5112	Warning	-	W.24V supply	24 V supply critical
0x6010	Warning	-	Watchdog reset	Watchdog time-out
0x6181	Fault	-	Time-out 125 us task	Time-out in 125 us task
0x6182	Fault	-	Time-out 250 us task	Time-out in 250 us task
0x6183	Fault	-	Time-out 1 ms task	Time-out in 1 ms task
0x6184	Fault	-	Time-out 8 ms task	Time-out in 8 ms task
0x6188	Fault	-	Error dF12	Internal error
0x6189	Fault	-	Programming error	Power section programming error
0x618A	Warning	-	Int. fan error	Internal fan error
0x6190	Fault	-	PS COM inapplicable	Communication protocol version in the power section inapplicable
0x6191	Trouble	-	Sync.error PS	Communication in the power section not synchronous
0x6192	Trouble	-	Rx error PS	Communication reception error in the power section at control unit
0x6193	Fault	-	rx error power sec.	Power section comm. reception error
0x6194	Fault	-	COM SDO abort PS	PDO communication with power section aborted
0x6195	Warning	-	I2C conn. lost	I2C connection lost
0x6196	Warning	-	I2C bus error	I2C bus error
0x61B0	Fault	-	PS uC supply err.	uC supply voltage drop in the power section
0x61B1	Fault	-	Err. PS general	General error in the power section
0x6280	Fault	-	Incorrectly connected	Trigger/functions connected incorrectly
0x6281	Fault	-	User-def fault 1	User-defined fault 1 initiated via trigger/function
0x6282	Fault	-	User-def fault 2	User-defined fault 2 initiated via trigger/function
0x6290	Warning	-	Backw dir.prot.	Reversal warning
0x6291	Fault	-	Fault overflow	Number of maximum permissible faults exceeded
0x62A0	Fault	-	AC ctrl user err	AC control user error
0x62A1	Fault	-	User-def fault 1	User-defined fault 1 triggered via network
0x62A2	Fault	-	User-def fault 2	User-defined fault 2 triggered via network
0x62B1	Fault	-	NetwordIN1 error	NetwordIN1 function assignment incorrect
0x63A0	Fault	-	Eeprom error	On-board EEPROM access error
0x63A1	Fault	-	id tag error CU	Loading the ID tag calibration data in the control unit failed
0x63A2	Fault	-	ID tag error PS	Loading the ID tag calibration data in the power section failed
0x63A3	Fault	-	Error PS31	Power section unknown
0x63A4	Warning	-	OBEE T. OVERFL.	OBEE timer overflow
0x7080	Fault	-	Error SL	Assertion level monitoring

Diagnostics and fault elimination

Short overview of all error codes



Error code	Type	Adjustable in	Keypad display	Info
0x7081	Error	0x2636:010 (PAR 430/010)	Aln 01 error	Monitoring of analog input 1
0x7082	Error	0x2637:010 (PAR 431/010)	Error Aln 02	Monitoring of analog input 2
0x70A1	Warning	-	Err. analog outp 01	Monitoring of analog output 1
0x70A2	Warning	-	Err. analog outp 02	Monitoring of analog output 2
0x7121	Fault	-	Pole pos ID err.	Pole position identification error
0x7180	Error	0x2D46:002 (PAR 353/002)	Motor overcurrent	Motor overcurrent
0x7305	Warning	0x2C45 (PAR 342)	Fdbck err open circ	Open circuit - feedback system
0x7580	No response	0x218B	Tr. error diag. tx	Error when sending diagnostic messages
0x7581	No response	0x218B	Rec. error diag. rx	Error when receiving diagnostic messages
0x7680	Fault	-	EPM full	Memory module is full
0x7681	Fault	-	No EPM	No memory module
0x7682	Fault	-	EPM inv. data	Memory module contains invalid user data
0x7683	Fault	-	EPM access err.	Memory module access error
0x7684	Fault	-	EPM mem. error	Data not completely saved in the memory module before switch-off
0x7685	Fault	-	Netw. module new	New inverter hardware (network) detected
0x7686	Fault	-	Netw.conf.error	Network: configuration error
0x7687	Warning	-	EPM timer overflow	Memory module timer overflow
0x7688	Warning	-	EPM is empty	Memory module is empty
0x8182	Trouble	0x2857:010	CAN bus off	CAN bus off
0x8183	Warning	0x2857:011	CAN bus warning	CAN warning
0x8184	Error	0x2857:005	CAN heartb. C1	CAN heartbeat time-out consumer 1
0x8185	Error	0x2857:006	CAN heartb. C2	CAN heartbeat time-out consumer 2
0x8186	Error	0x2857:007	CAN heartb. C3	CAN heartbeat time-out consumer 3
0x8187	Error	0x2857:008	CAN heartb. C4	CAN heartbeat time-out consumer 4
0x8190	Error	0x2859:001 (PAR 515/001)	WD elapsed	Network: watchdog elapsed
0x8191	No response	0x2859:002 (PAR 515/002)	Cycl dat interr	Network: interruption of cyclic data exchange
0x8192	Error	0x2859:004 (PAR 515/004)	Communic.error	Network: communication error
0x8193	Trouble	0x2859:005 (PAR 515/005)	Inv cycl data	Network: invalid cyclic process data
0x81A0	Warning	-	Transm. error Modbus tx	Modbus: error when sending messages
0x81A1	Error	0x2858:001 (PAR 515/001)	Modbus TO	Modbus time-out
0x81A2	Warning	-	Modbus EC	Modbus: incorrect request by master
0x8286	Error	0x2859:003 (PAR 515/003)	PDO mapping error	Network: PDO mapping error
0x8291	Error	0x2857:001	TO RxPDO1	CAN RPDO1 time-out
0x8292	Error	0x2857:002	TO RxPDO2	CAN RPDO2 time-out
0x8293	Error	0x2857:003	TO RxPDO3	CAN RPDO3 time-out
0x9080	Fault	-	Keypad removed	Error - keypad removed
0xFF02	Error	0x2550:011 (PAR 707/011)	OC12 error	Brake resistor overload error
0xFF05	Fault	-	Safety error	Safety monitoring error
0xFF06	Error	0x2D44:002 (PAR 350/002)	Motor overspeed.	Motor overspeed
0xFF09	No response	0x2D45:001 (PAR 310/001)	Volt. phase error	Motor phase failure
0xFF0A	No response	0x2D45:001 (PAR 310/001)	PhaseU volt. err.	Phase U motor phase failure
0xFF0B	No response	0x2D45:001 (PAR 310/001)	PhaseV volt. err.	Motor phase failure phase V



Diagnostics and fault elimination

Short overview of all error codes

Error code	Type	Adjustable in	Keypad display	Info
0xFF0C	No response	0x2D45:001 (PAR 310/001)	PhaseW volt. err.	Motor phase failure phase W
0xFF19	Fault	-	ID1 error	Motor parameter identification error
0xFF30	Info	-	Tmonit. without resp.	Test monitoring does not generate any response
0xFF31	Warning	-	Tmonit. warning	Tmonit. generates warning
0xFF32	Trouble	-	Tmonit. fault	Test monitoring generates fault
0xFF33	Fault	-	Tmonit. error	Test monitoring generates error
0xFF34	Fault	-	Tmonit. del. err	Test monitoring generates error with a delayed error reset
0xFF35	Fault	-	Tmonit. error block	Test monitoring generates error with blocked error reset
0xFF36	Warning	0x2550:010 (PAR 707/010)	W.OL12	Brake resistor overload warning
0xFF37	Fault	-	Auto-start inh.	Automatic start at switch-on inhibited
0xFF56	Warning	-	W.MaxFrequency	Max. output frequency reached

Basic setting

Short overview of all error codes



6 Basic setting

- [Mains voltage](#) 67
- [Control source selection](#) 69
- [Selection of setpoint source](#) 70
- [Starting/stopping performance](#) 72
- [Frequency limits and ramp times](#) 73
- [Quick stop](#) 74
- [S-shaped ramps](#) 75
- [Optical device identification](#) 76



6.1 Mains voltage

The rated mains voltage set for the inverter has an impact on the operating range of the inverter.

Details

By default, the rated mains voltage is set in [0x2540:001 \(PAR 208/001\)](#) according to the inverter type code.



Check the setting of the rated mains voltage in [0x2540:001 \(PAR 208/001\)](#). Ensure that it matches the actual mains voltage applied!

The following results from the rated mains voltage set:

- the error threshold for monitoring the DC-bus voltage and
- the voltage threshold for braking operation ("brake chopper threshold").

Monitoring of the DC-bus voltage

- The warning thresholds for monitoring are adjustable.
- The error thresholds and reset thresholds for monitoring result from the rated mains voltage set:

Rated mains voltage	Undervoltage thresholds			Overvoltage thresholds		
	Warning threshold	Error threshold	Reset threshold	Warning threshold	Error threshold	Reset threshold
Setting in 0x2540:001 (PAR 208/001)	Setting in 0x2540:002 (PAR 208/002)	Display in 0x2540:003 (PAR 208/003)	Display in 0x2540:004 (PAR 208/004)	Setting in 0x2540:005 (PAR 208/005)	Display in 0x2540:006 (PAR 208/006)	Display in 0x2540:007 (PAR 208/007)

- If the DC-bus voltage of the inverter falls below the undervoltage error threshold, the "Trouble" response is triggered.
- If the DC-bus voltage of the inverter exceeds the overvoltage error threshold, the "Fault" response is triggered.



When the undervoltage or overvoltage monitoring function has been activated, the drive is not restarted automatically.

Parameter	Name / value range / [default setting]	Info						
0x2540:001 (PAR 208/001)	Mains voltage: Rated mains voltage (Mains volt. sett.: AC input volt.) • Setting can only be changed if controller inhibit is active. <table border="1"> <tr> <td>0</td> <td>230 Veff</td> </tr> <tr> <td>1</td> <td>400 Veff</td> </tr> <tr> <td>2</td> <td>480 Veff</td> </tr> </table>	0	230 Veff	1	400 Veff	2	480 Veff	Selection of the mains voltage for actuating the inverter.
0	230 Veff							
1	400 Veff							
2	480 Veff							
0x2540:002 (PAR 208/002)	Mains voltage: Undervoltage warning threshold (Mains volt. sett.: LU warning level) 0 ... [0]* ... 800 V • Default setting depending on the size.	Setting of the warning threshold for monitoring DC bus undervoltage. • If the DC bus voltage falls below the threshold set, the inverter outputs a warning. • The warning is reset with a hysteresis of 10 V.						
0x2540:003 (PAR 208/003)	Mains voltage: Undervoltage error threshold (Mains volt. sett.: LU error level) • Read only: x V • Default setting depending on the size.	Display of the fixed error threshold for monitoring DC bus undervoltage. • If the DC-bus voltage falls below the threshold displayed, the "Fault" response is triggered.						
0x2540:004 (PAR 208/004)	Mains voltage: Undervoltage reset threshold (Mains volt. sett.: LU deletion level) • Read only: x V • Default setting depending on the size.	Display of the fixed reset threshold for monitoring DC bus undervoltage.						

Basic setting

Mains voltage



Parameter	Name / value range / [default setting]	Info
0x2540:005 (PAR 208/005)	Mains voltage: Overvoltage warning threshold (Mains volt. sett.: OU warning level) 0 ... [0]* ... 800 V • Default setting depending on the size.	Setting of the warning threshold for monitoring DC bus overvoltage. • If the DC bus voltage exceeds the threshold set, the inverter outputs a warning. • The warning is reset with a hysteresis of 10 V.
0x2540:006 (PAR 208/006)	Mains voltage: Overvoltage error threshold (Mains volt. sett.: OU error level) • Read only: x V • Default setting depending on the size.	Display of the fixed error threshold for monitoring the DC bus overvoltage. • If the DC-bus voltage exceeds the threshold displayed, the "Fault" response is triggered.
0x2540:007 (PAR 208/007)	Mains voltage: Overvoltage reset threshold (Mains volt. sett.: OU deletion level) • Read only: x V • Default setting depending on the size.	Display of the fixed reset threshold for monitoring DC bus overvoltage.



6.2 Control source selection

"Control sources" are the signal sources from which the inverter receives its start, stop, and reversal commands.

Possible control sources are:

- Digital inputs
- Process input data (network)
- Keypad keys



Irrespective of the control source selection, stop commands are always active from each source connected! If, for instance, the inverter is configured for control via network and a keypad is connected for the purpose of diagnostics, the inverter is also stopped when the  keypad key is pressed.

Details

- In the Lenze setting [0x2824 \(PAR 200\)](#) = "terminal mode [0]", inverter control can be adapted individually to the respective application.
 - By default, the inverter can be controlled via the I/O terminals. ▶ [Function assignment of the inputs and outputs](#) [21](#)
 - Detailed information regarding the adaptation of the I/O configuration can be found in the "[Flexible I/O configuration](#)" chapter. [186](#)
- If the keypad is to be used as the sole control source for the application, selection "Keypad [1]" is to be set in [0x2824 \(PAR 200\)](#).
- The control source that is currently active is shown in [0x282B:001 \(PAR 125/001\)](#).

Parameter	Name / value range / [default setting]	Info
0x2824 (PAR 200)	Control selection (Control source)	Selection of the type of inverter control.
	0 Terminal mode (flexible I/O configuration)	This selection enables a flexible assignment of the start, stop, and rotating direction commands with digital signal sources (e.g. digital inputs, process data received via network).
	1 Keypad	This selection enables starting and stopping of the inverter exclusively via the start and stop key of the keypad. <ul style="list-style-type: none"> • Other signal sources for starting the inverter are ignored. • This selection is advisable for an initial functional test if no external control sources are connected yet.
0x282B:001 (PAR 125/001)	Inverter diagnostics: Active control source (Inverter diag.: Active ctrl)	Display of the control source that is currently active.
	• Read only	
	0 Flexible I/O configuration	
	1 Network	
	2 Keypad	
	3 Internal	
	4	
	5	
6		
7		

Basic setting

Selection of setpoint source



6.3 Selection of setpoint source

"Setpoint sources" are the signal sources from which the inverter receives its setpoints for the different operating modes.

Possible setpoint sources are:

- Analog inputs
- Keypad
- Process input data (network)
- Parameterisable setpoints (preset values)
- "Motor potentiometer" function

Details

- For applications only requiring one setpoint it is sufficient to define the standard setpoint source in the following parameters.
- For applications requiring a change-over of the setpoint source during operation, the function assignment of the functions for the setpoint selection has to be configured correspondingly. [▶ Flexible I/O configuration](#) [□ 186](#)

Parameter	Name / value range / [default setting]	Info
0x2860:001 (PAR 201/001)	Standard setpoint sources: Frequency setpoint source (Standard setpoint: Frequency setp.)	Selection of the standard setpoint source for speed mode. <ul style="list-style-type: none"> • The standard setpoint source is always active in speed mode if no setpoint change-over to another setpoint source via corresponding triggers/functions is active. ▶ Setpoint change-over □ 193
	1 Keypad	The setpoint is specified locally by the keypad. <ul style="list-style-type: none"> • Default setting: 0x2601:001 (PAR 202/001) • Use the ↑ and ↓ navigation keys to change the keypad setpoint (also during running operation).
	2 Analog input 1	The setpoint is specified analogously via X3/AI1. ▶ Analog input 1 □ 211
	3 Analog input 2	The setpoint is specified analogously via X3/AI2. ▶ Analog input 2 □ 213
	5 Network	The setpoint is specified via network. ▶ Configuring the network □ 96
	11 Preset frequency val. 1	For the setpoint selection, preset values can be parameterised and selected. ▶ Setpoint source of preset setpoints □ 195
	12 Preset frequency val. 2	
	13 Preset frequency val. 3	
	14 Preset frequency val. 4	
	15 Preset frequency val. 5	
	16 Preset frequency val. 6	
	17 Preset frequency val. 7	
	18 Preset frequency val. 8	
	19 Preset frequency val. 9	
	20 Preset frequency val. 10	
	21 Preset frequency val. 11	
	22 Preset frequency val. 12	
23 Preset frequency val. 13		
24 Preset frequency val. 14		
25 Preset frequency val. 15		
50 Motor potentiometer	The setpoint is generated by the "Motor potentiometer" function. ▶ Motor potentiometer setpoint source □ 198	
0x2860:002 (PAR 201/002)	Standard setpoint sources: Process controller setpoint source (Standard setpoint: PID setpoint)	Selection of the standard setpoint source for process controller mode. <ul style="list-style-type: none"> • The standard setpoint source is always active in process controller mode if no setpoint change-over to another setpoint source via corresponding triggers/functions is active.
	1 Keypad	The setpoint is specified locally by the keypad. <ul style="list-style-type: none"> • Default setting: 0x2601:002 (PAR 202/002) • Use the ↑ and ↓ navigation keys to change the keypad setpoint (also during running operation).



Basic setting

Selection of setpoint source Keypad setpoint default setting

Parameter	Name / value range / [default setting]	Info
	2 Analog input 1	The setpoint is specified analogously via X3/AI1. ▶ Analog input 1 □ 211
	3 Analog input 2	The setpoint is specified analogously via X3/AI2. ▶ Analog input 2 □ 213
	5 Network	The setpoint is specified via network. Configuring the network □ 96
	11 Process controller preset val. 1	For the setpoint selection, preset values can be parameterised and selected. ▶ Setpoint source of preset setpoints □ 195
	12 Process controller preset val. 2	
	13 Process controller preset val. 3	
	14 Process controller preset val. 4	
	15 Process controller preset val. 5	
	16 Process controller preset val. 6	
	17 Process controller preset val. 7	
	18 Process controller preset val. 8	
	50 Motor potentiometer	The setpoint is generated by the "Motor potentiometer" function. ▶ Motor potentiometer setpoint source □ 198
0x2860:003 (PAR 201/003)	Standard setpoint sources: Torque setpoint source (Standard setpoint: Torque setp.)	Selection of the standard setpoint source for torque mode. • The standard setpoint source is always active in torque mode if no setpoint change-over to another setpoint source via corresponding triggers/functions is active.
	1 Keypad	The setpoint is specified locally by the keypad. • Use the ↑ and ↓ navigation keys to change the keypad setpoint (also during running operation).
	2 Analog input 1	The setpoint is specified analogously via X3/AI1. ▶ Analog input 1 □ 211
	3 Analog input 2	The setpoint is specified analogously via X3/AI2. ▶ Analog input 2 □ 213
	50 Motor potentiometer	The setpoint is generated by the "Motor potentiometer" function. ▶ Motor potentiometer setpoint source □ 198

6.3.1 Keypad setpoint default setting

For the manual setpoint selection via keypad the following default settings are used.

Parameter	Name / value range / [default setting]	Info
0x2601:001 (PAR 202/001)	Keypad setpoints: Frequency setpoint (Keypad setpoints: KP freq. setp.) 0.0 ... [20.0] ... 599.0 Hz	Default setting of the keypad setpoint for speed mode.
0x2601:002 (PAR 202/002)	Keypad setpoints: Process controller setpoint (Keypad setpoints: KP PID setp.) -300.00 ... [0.00] ... 300.00 PUnit	Default setting of the keypad setpoint for process controller mode.

Basic setting

Starting/stopping performance
Starting performance

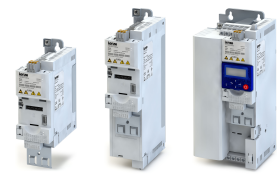

6.4 Starting/stopping performance

6.4.1 Starting performance

Parameter	Name / value range / [default setting]	Info
0x2838:001 (PAR 203/001)	Start/stop configuration: Start method (Start/stop config: Start method)	Starting performance of the inverter.
	• Setting can only be changed if controller inhibit is active.	
	0 Normal	After switch-on, the standard ramps are active. <ul style="list-style-type: none"> Acceleration time 1 can be set in 0x2917 (PAR 220). Deceleration time 1 can be set in 0x2918 (PAR 221).
	1 Start with DC braking	After switch-on, the "DC braking" function is active for the time set in 0x2B84:002 (PAR 704/002) . ▶ DC braking □ 153
2 Flying Start	After switch-on, the "Restart on the fly" function is active. This function makes it possible to restart a coasting motor on the fly during operation without speed feedback. Synchronicity between the inverter and the motor is coordinated so that the transition to the rotating drive is effected without jerk at the time of connection. ▶ Flying restart function □ 182	
0x2838:002 (PAR 203/002)	Start/stop configuration: Start at switch-on (Start/stop config: Start at switch-on)	Behaviour after mains connection.
	0 Off	If the controller is enabled at mains power-up, the inverter remains in the "Ready to switch on" state. For a change-over to the "Switched on" state, controller enable must be deactivated first. Only with the following controller enable, a change-over to the "Operation enabled" state is effected, and the motor follows the setpoint specified.
	1 On	If the controller is enabled at mains power-up, after mains power-up the motor directly follows the setpoint specified. With this setting, the inverter directly changes from the "Ready to switch on" state to the "Switched on" state and then to the "Operation enabled" state.

6.4.2 Stopping performance

Parameter	Name / value range / [default setting]	Info
0x2838:003 (PAR 203/003)	Start/stop configuration: Stop method (Start/stop config: Stop method)	Behaviour after the "Stop" command.
	0 Coasting	The motor coasts down to standstill.
	1 Standard Ramp	The motor is brought to a standstill with deceleration time 1 (or deceleration time 2, if activated). <ul style="list-style-type: none"> Deceleration time 1 can be set in 0x2918 (PAR 221). Deceleration time 2 can be set in 0x291A (PAR 223). ▶ Frequency limits and ramp times □ 73
	2 Quick stop ramp	The motor is brought to a standstill with the deceleration time set for the "Quick stop" function. <ul style="list-style-type: none"> Deceleration time for quick stop can be set in 0x291C (PAR 225).



6.5 Frequency limits and ramp times

The frequency range can be limited by setting a minimum and maximum frequency. For the frequency setpoint, two different ramps can be parameterised. Change-over to ramp 2 can be carried out manually or automatically.

Details

- The acceleration time set refers to the acceleration from standstill to the maximum frequency set. In the case of a lower setpoint selection, the actual acceleration time is reduced accordingly.
- The deceleration time set refers to the deceleration from the maximum frequency set to standstill. In the case of a lower actual frequency, the actual deceleration time is reduced accordingly.
- Change-over to the acceleration and deceleration time set for ramp 2 is effected automatically if
 - "Motor potentiometer" function is active, or
 - frequency setpoint (absolute value) > auto-change-over threshold [0x291B \(PAR 224\)](#).
- With the "Activate ramp 2" function, acceleration time 2 and deceleration time 2 can be activated manually. ▶ [Activating ramp 2 manually](#) 204

Parameter	Name / value range / [default setting]	Info
0x2915 (PAR 210)	Minimum frequency (<i>Min. frequency</i>) 0.0 ... [0.0] ... 599.0 Hz	Lower limit value for all frequency setpoints.
0x2916 (PAR 211)	Maximum frequency (<i>Max. frequency</i>) 0.0 ... [50.0] ... 599.0 Hz	Upper limit value for all frequency setpoints.
0x2917 (PAR 220)	Acceleration time 1 (<i>Acceleration time 1</i>) 0.0 ... [5.0] ... 3600.0 s	The acceleration time set refers to the acceleration from standstill to the maximum frequency set. In the case of a lower setpoint selection, the actual acceleration time is reduced accordingly.
0x2918 (PAR 221)	Deceleration time 1 (<i>Deceleration time 1</i>) 0.0 ... [5.0] ... 3600.0 s	The deceleration time set refers to the deceleration from the maximum frequency set to standstill. In the case of a lower actual frequency, the actual deceleration time is reduced accordingly.
0x2919 (PAR 222)	Acceleration time 2 (<i>Acceleration time 2</i>) 0.0 ... [5.0] ... 3600.0 s	The acceleration time set refers to the acceleration from standstill to the maximum frequency set. In the case of a lower setpoint selection, the actual acceleration time is reduced accordingly. Acceleration time 2 is active if <ul style="list-style-type: none"> • "Motor potentiometer" function is active, or • frequency setpoint (absolute value) > auto-change-over threshold 0x291B (PAR 224), or • the trigger assigned in 0x2631:039 (PAR 400/039) of the "Activate ramp 2" function is TRUE.
0x291A (PAR 223)	Deceleration time 2 (<i>Deceleration time 2</i>) 0.0 ... [5.0] ... 3600.0 s	The deceleration time set refers to the deceleration from the maximum frequency set to standstill. In the case of a lower actual frequency, the actual deceleration time is reduced accordingly. Deceleration time 2 is active if <ul style="list-style-type: none"> • "Motor potentiometer" function is active, or • frequency setpoint (absolute value) > auto-change-over threshold 0x291B (PAR 224), or • the trigger assigned in 0x2631:039 (PAR 400/039) of the "Activate ramp 2" function is TRUE.
0x291B (PAR 224)	Auto-changeover threshold of ramp 2 (<i>Switch ramp</i>) 0.0 ... [0.0] ... 599.0 Hz	Threshold for the automatic change-over to acceleration time 2 and deceleration time 2. <ul style="list-style-type: none"> • A change-over is effected if the frequency setpoint (absolute value) > auto-changeover threshold. • With the setting 0, the automatic change-over function is deactivated.

Basic setting

Quick stop



6.6 Quick stop

Parameter	Name / value range / [default setting]	Info
0x291C (PAR 225)	Quick stop deceleration time (QSP dec. time) 0.0 ... [1.0] ... 3600.0 s	If the "Quick stop" function is activated, the motor is brought to a standstill within the deceleration time set here. The deceleration time set refers to the deceleration from the maximum frequency set to standstill. In the case of a lower actual frequency, the actual deceleration time is reduced accordingly.
0x2631:003 (PAR 400/003)	Function assignment: Quick stop (Function list: Quick stop) <ul style="list-style-type: none">Setting can only be changed if controller inhibit is active.For possible settings see description for 0x2631:001 (PAR 400/001). 188	Assignment of a trigger for the "Quick stop" function. Trigger = TRUE: "Quick stop" function activated. Trigger = FALSE: no action / deactivate function again. Notes: <ul style="list-style-type: none">The "Quick stop" function brings the motor to a standstill within the deceleration time set in 0x291C (PAR 225).The "Quick stop" function has a higher priority than the "Start enable" function.
	00 Not connected	No trigger assigned (trigger is constantly FALSE).



6.7 S-shaped ramps

In order to reduce the jerk and to therefore prevent the drive components from damage, a smoothing factor can be set for the acceleration/deceleration ramps.

Details

- Setting a smoothing factor produces S-shaped ramps for the acceleration/deceleration.
- This type of acceleration/deceleration is for example required for sensitive machine parts with a certain amount of play.
- The total acceleration time and deceleration time increase correspondingly (see the following examples).

Example 1: smoothing factor = 50 %

- Total acceleration time = 1.5 * acceleration time
- Total deceleration time = 1.5 * deceleration time

Example 2: smoothing factor = 100 %

- Total acceleration time = 2 * acceleration time
- Total deceleration time = 2 * deceleration time

Parameter	Name / value range / [default setting]	Info
0x291E:001 (PAR 226/001)	S-Ramp characteristic: Smoothing factor (S-ramp char.: S-Ramp smoothing) 0.0 ... [0.0] ... 100.0 %	Factor for S-rounding of the acceleration/deceleration ramps. <ul style="list-style-type: none"> • With the setting "0.0", the S-rounding is deactivated and acceleration/deceleration with linear ramps is carried out.



6.8 Optical device identification

For applications including several interconnected inverters it may be difficult to locate a device that has been connected online. The "Optical device identification" function serves to locate the inverter by means of blinking LEDs.

Parameter	Name / value range / [default setting]	Info		
0x2021:001 (PAR 230/001)	Optical device identification: Start detection (Opt.dev.det.: Opt.det: start)	1 = start optical device identification. <ul style="list-style-type: none"> After the start-up, the two "RDY" and "ERR" LEDs on the front of the inverter are blinking at a blinking frequency of 20 Hz for the blinking duration set in 0x2021:2. Then the setting is automatically reset to "0". If the function is reactivated within the blinking time set, the time is extended correspondingly. A manual reset to "0" makes it possible to stop the function prematurely. 		
	<table border="1"> <tr> <td>0</td> <td>Stop</td> </tr> <tr> <td>1</td> <td>Start</td> </tr> </table>		0	Stop
0	Stop			
1	Start			
0x2021:002 (PAR 230/002)	Optical device identification: Blinking duration (Opt.dev.det.: Opt.det: time) 0 ... [5] ... 3600 s			



7 Motor control

- [Motor data](#) 78
- [Motor control selection](#) 81
- [Optimisation of motor control](#) 84
- [Optimisation of the control loops](#) 89
- [Motor rotating direction](#) 90
- [Switching frequency changeover](#) 91
- [Motor protection](#) 92

Motor control

Motor data



7.1 Motor data

The term "motor data" comprises all parameters only depending on the motor and only characterising the electrical behaviour of the machine. Motor data are independent of the application in which the inverter and the motor are used.

Preconditions

When you enter the motor nameplate data, take into account the phase connection implemented for the motor (star or delta connection). Only enter the data applying to the connection type selected.

Parameter	Name / value range / [default setting]	Info						
0x2822:004 (PAR 327/004)	Axis commands: Motor identification (Axis commands: Mot. ident.) 0 ... [0] ... 1	1 = start automatic calibration of the motor in "Energized" mode in order to identify the inverter characteristic and the motor parameters. Note: Before the procedure is started, the following parameters must be set correctly: <ul style="list-style-type: none"> • Motor control type 0x2C00 (PAR 300) • Motor rated current 0x6075 (PAR 323) • Rated speed 0x2C01:004 (PAR 320/004) • Rated frequency 0x2C01:005 (PAR 320/005) • Rated power 0x2C01:006 (PAR 320/006) • Rated voltage 0x2C01:007 (PAR 320/007) • Cosine phi 0x2C01:008 (PAR 320/008) 						
0x2822:005 (PAR 327/005)	Axis commands: Motor assessment (Axis commands: Motor assessment) 0 ... [0] ... 1	1 = start automatic calibration of the motor in "Non-energized" mode in order to assess the inverter characteristic and the motor parameters. Note: Before the procedure is started, the following parameters must be set correctly: <ul style="list-style-type: none"> • Motor control type 0x2C00 (PAR 300) • Motor rated current 0x6075 (PAR 323) • Rated speed 0x2C01:004 (PAR 320/004) • Rated frequency 0x2C01:005 (PAR 320/005) • Rated power 0x2C01:006 (PAR 320/006) • Rated voltage 0x2C01:007 (PAR 320/007) • Cosine phi 0x2C01:008 (PAR 320/008) 						
0x2910:001 (PAR 335/001)	Moment of inertia values: Motor (Moment of inertia: Motor inertia) 0.00 ... [3.70]* ... 20000000.00 kg cm ² <ul style="list-style-type: none"> • Default setting depending on the size. 	Setting of the moment of inertia of the motor.						
0x2910:002 (PAR 335/002)	Moment of inertia values: Load (Moment of inertia: Load inertia) 0.00 ... [3.70]* ... 20000000.00 kg cm ² <ul style="list-style-type: none"> • Default setting depending on the size. 	Setting of the moment of inertia of the load.						
0x2910:003	Moment of inertia values: Coupling <table border="1" style="width: 100%; border-collapse: collapse;"> <tr> <td style="text-align: center;">0</td> <td>Rigid</td> </tr> <tr> <td style="text-align: center;">1</td> <td>Flexible</td> </tr> <tr> <td style="text-align: center;">2</td> <td>With clearance</td> </tr> </table>	0	Rigid	1	Flexible	2	With clearance	Selection of the type of coupling between the moment of inertia of the motor and that of the load.
0	Rigid							
1	Flexible							
2	With clearance							
0x2947:001	Inverter characteristic: y1 = U1 (x = 0.00 %) 0.00 ... [0.00]* ... 20.00 V <ul style="list-style-type: none"> • Default setting depending on the size. 	The inverter characteristic (consisting of 17 values) is calculated and completed in the course of the motor identification/motor assessment process. Note: Changing these values is not recommended by Lenze.						
0x2947:002	Inverter characteristic: y2 = U2 (x = 6.25 %) 0.00 ... [0.00]* ... 20.00 V <ul style="list-style-type: none"> • Default setting depending on the size. 							
0x2947:003	Inverter characteristic: y3 = U3 (x = 12.50 %) 0.00 ... [0.00]* ... 20.00 V <ul style="list-style-type: none"> • Default setting depending on the size. 							
0x2947:004	Inverter characteristic: y4 = U4 (x = 18.75 %) 0.00 ... [0.00]* ... 20.00 V <ul style="list-style-type: none"> • Default setting depending on the size. 							
0x2947:005	Inverter characteristic: y5 = U5 (x = 25.00 %) 0.00 ... [0.00]* ... 20.00 V <ul style="list-style-type: none"> • Default setting depending on the size. 							
0x2947:006	Inverter characteristic: y6 = U6 (x = 31.25 %) 0.00 ... [0.00]* ... 20.00 V <ul style="list-style-type: none"> • Default setting depending on the size. 							



Parameter	Name / value range / [default setting]	Info
0x2947:007	Inverter characteristic: y7 = U7 (x = 37.50 %) 0.00 ... [0.00]* ... 20.00 V • Default setting depending on the size.	
0x2947:008	Inverter characteristic: y8 = U8 (x = 42.75 %) 0.00 ... [0.00]* ... 20.00 V • Default setting depending on the size.	
0x2947:009	Inverter characteristic: y9 = U9 (x = 50.00 %) 0.00 ... [0.00]* ... 20.00 V • Default setting depending on the size.	
0x2947:010	Inverter characteristic: y10 = U10 (x = 56.25 %) 0.00 ... [0.00]* ... 20.00 V • Default setting depending on the size.	
0x2947:011	Inverter characteristic: y11 = U11 (x = 62.50 %) 0.00 ... [0.00]* ... 20.00 V • Default setting depending on the size.	
0x2947:012	Inverter characteristic: y12 = U12 (x = 68.75 %) 0.00 ... [0.00]* ... 20.00 V • Default setting depending on the size.	
0x2947:013	Inverter characteristic: y13 = U13 (x = 75.00 %) 0.00 ... [0.00]* ... 20.00 V • Default setting depending on the size.	
0x2947:014	Inverter characteristic: y14 = U14 (x = 81.25 %) 0.00 ... [0.00]* ... 20.00 V • Default setting depending on the size.	
0x2947:015	Inverter characteristic: y15 = U15 (x = 87.50 %) 0.00 ... [0.00]* ... 20.00 V • Default setting depending on the size.	
0x2947:016	Inverter characteristic: y16 = U16 (x = 93.25 %) 0.00 ... [0.00]* ... 20.00 V • Default setting depending on the size.	
0x2947:017	Inverter characteristic: y17 = U17 (x = 100.00 %) 0.00 ... [0.00]* ... 20.00 V • Default setting depending on the size.	
0x2C01:001	Motor parameters: Number of pole pairs • Read only	Display of the number of pole pairs calculated from the rated speed and rated frequency.
0x2C01:002	Motor parameters: Stator resistance 0.0000 ... [10.1565]* ... 125.0000 Ohm • Default setting depending on the size.	General motor parameters. Carry out settings as specified by manufacturer data/motor data sheet.
0x2C01:003	Motor parameters: Stator leakage inductance 0.000 ... [23.566]* ... 500.000 mH • Default setting depending on the size.	
0x2C01:004 (PAR 320/004)	Motor parameters: Rated speed (Motor parameters: Mot. speed) 50 ... [1450] ... 50000 rpm	General motor parameters. Carry out settings as specified by motor nameplate data.
0x2C01:005 (PAR 320/005)	Motor parameters: Rated frequency (Motor parameters: Mot. frequency) 1.0 ... [50.0] ... 1000.0 Hz	
0x2C01:006 (PAR 320/006)	Motor parameters: Rated power (Motor parameters: Motor power) 0.00 ... [0.25]* ... 655.35 kW • Default setting depending on the size.	
0x2C01:007 (PAR 320/007)	Motor parameters: Rated voltage (Motor parameters: Motor voltage) 0 ... [230]* ... 65535 V • Default setting depending on the size.	
0x2C01:008 (PAR 320/008)	Motor parameters: Cosine phi (Motor parameters: Mot. cosine phi) 0.00 ... [0.80] ... 1.00	
0x2C01:010	Motor parameters: Name	

Motor control

Motor data





Parameter	Name / value range / [default setting]	Info
0x2C02:001 (PAR 351/001)	Motor parameter (ASM): Rotor resistance (ASM motor par.: ASM rotor res.) 0.0000 ... [8.8944]* ... 200.0000 Ohm • Default setting depending on the size.	Equivalent circuit data of the motor required for the motor model.
0x2C02:002 (PAR 351/002)	Motor parameter (ASM): Mutual inductance (ASM motor par.: ASM mutual ind.) 0.0 ... [381.9]* ... 50000.0 mH • Default setting depending on the size.	
0x2C02:003 (PAR 351/003)	Motor parameter (ASM): Magnetising current (ASM motor par.: ASM magn. current) 0.00 ... [0.96]* ... 500.00 A • Default setting depending on the size.	
0x6075 (PAR 323)	Motor rated current (Motor current) 0.001 ... [1.700]* ... 500.000 A • Default setting depending on the size. • Setting can only be changed if controller inhibit is active.	The rated motor current to be set here serves as a reference value for different parameters with a setting/display in percent. Relevant parameters: <ul style="list-style-type: none"> • DC braking: Current 0x2B84:001 (PAR 704/001) • Flying restart circuit: Current 0x2BA1:001 (PAR 718/001) • Motor overload monitoring ($i^2 \cdot t$): Maximum utilisation [60 s] 0x2D4B:001 (PAR 308/001) • Max current 0x6073 (PAR 324) • Current actual value 0x6078 (PAR 103)
0x6076 (PAR 325)	Motor rated torque (Motor torque) 0.001 ... [1.650]* ... 1000.000 Nm • Default setting depending on the size. • Setting can only be changed if controller inhibit is active.	The rated motor torque to be set here serves as a reference value for different parameters with a setting/display in percent. Relevant parameters: <ul style="list-style-type: none"> • Torque actual value 0x6077 (PAR 107)
0x6080 (PAR 322)	Max motor speed (Max. motor speed) 0 ... [6075] ... 480000 rpm	Limitation of the maximum motor speed.



7.2 Motor control selection

The inverter supports different modes for closed-loop/open-loop motor control.

Parameter	Name / value range / [default setting]	Info
0x2C00 (PAR 300)	Motor control type (<i>Motor ctrl mode</i>)	Selection of the motor control type.
	<ul style="list-style-type: none"> Setting can only be changed if controller inhibit is active. 	
	4 Sensorless vector control (SLVC)	This control type is used for sensorless vector control of an asynchronous motor. ▶ Sensorless vector control (SLVC)  82
6 V/f characteristic control (VFC open loop)	This control mode is used for the speed control of an asynchronous motor via a V/f characteristic and is the simplest control mode. ▶ V/f characteristic control  81	

In the following subchapters, each motor control is described in detail.

7.2.1 V/f characteristic control

The V/f characteristic control is a motor control for conventional frequency inverter applications. It is based on a simple and robust control mode for the operation of asynchronous motors with a linear or square-law load torque characteristic (e.g. fan). Because of the minimal parameterisation effort, such applications can be commissioned easily and quickly.

Preconditions

- The V/f characteristic control is only suitable for asynchronous motors.
- If you want to actuate a drive with a square-law V/f characteristic: please always check whether the corresponding drive is suitable for operation with a square-law V/f characteristic!
- From the motor nameplate data, at least the rated speed and rated frequency must be entered, so that the inverter can calculate the correct number of pole pairs. ▶ [Motor data](#)  78
- The motor must only be actuated above the rated motor frequency/rated voltage if this is expressly approved by the motor manufacturer!

Details

This motor control type is activated by setting **0x2C00 (PAR 300)** = " V/f characteristic control (VFC open loop) [6]".

Parameter	Name / value range / [default setting]	Info
0x2B00 (PAR 302)	V/f characteristic shape (<i>V/f curve</i>)	Selection of the V/f characteristic shape for the adaptation to different load profiles.
	<ul style="list-style-type: none"> Setting can only be changed if controller inhibit is active. 	
	0 Linear 1 Square-law	Linear characteristic for drives with constant load torque over the speed. Square-law characteristic for drives with a linear or square-law load torque over the speed. <ul style="list-style-type: none"> Square-law V/f characteristics are preferably used for centrifugal pumps and fan drives. Please always check whether the corresponding drive is suitable for operation with a square-law V/f characteristic! If your pump drive or fan drive is not suitable for operation with a square-law V/f characteristic, use the linear V/f characteristic instead.
0x2B01:001 (PAR 303/001)	V/f characteristic data: Base voltage (<i>V/f char. data: Base voltage</i>) 0 ... [230] * ... 5000 V	Voltage in the reference point of the V/f characteristic. <ul style="list-style-type: none"> The V/f base voltage is usually set to the rated motor voltage 0x2C01:007 (PAR 320/007).
0x2B01:002 (PAR 303/002)	V/f characteristic data: Base frequency (<i>V/f char. data: Base frequency</i>) 0 ... [50] * ... 599 Hz	Frequency in the reference point of the V/f characteristic. <ul style="list-style-type: none"> The V/f base frequency is usually set to the rated motor frequency 0x2C01:005 (PAR 320/005).

Motor control

Motor control selection
Sensorless vector control (SLVC)



Parameter	Name / value range / [default setting]	Info						
0x2540:001 (PAR 208/001)	Mains voltage: Rated mains voltage (Mains volt. sett.: AC input volt.) <ul style="list-style-type: none"> Setting can only be changed if controller inhibit is active. <table border="1"> <tr> <td>0</td> <td>230 Veff</td> </tr> <tr> <td>1</td> <td>400 Veff</td> </tr> <tr> <td>2</td> <td>480 Veff</td> </tr> </table>	0	230 Veff	1	400 Veff	2	480 Veff	Selection of the mains voltage for actuating the inverter.
0	230 Veff							
1	400 Veff							
2	480 Veff							
0x2915 (PAR 210)	Minimum frequency (Min. frequency) 0.0 ... [0.0] ... 599.0 Hz	Lower limit value for all frequency setpoints.						
0x2916 (PAR 211)	Maximum frequency (Max. frequency) 0.0 ... [50.0] ... 599.0 Hz	Upper limit value for all frequency setpoints.						

7.2.1.1 Linear V/f characteristic

In the **0x2B00 (PAR 302)** = "Linear characteristic [0]" default setting, the motor voltage of the inverter is determined on the basis of a linear characteristic depending on the field frequency or motor speed to be generated. The voltage follows a preselected characteristic.

7.2.1.2 Square-law V/f characteristic

In the case of the setting **0x2B00 (PAR 302)** = "Square-law characteristic [1]", the motor voltage of the inverter is determined on the basis of a square-law characteristic depending on the field frequency or motor speed to be generated. The voltage follows a preselected characteristic.

7.2.2 Sensorless vector control (SLVC)

Sensorless (field-oriented) vector control for asynchronous motors is based on a decoupled, separate control for the torque-producing and the field-producing current component. In addition, the actual speed is reconstructed by means of a motor model so that a speed sensor is not required.

Preconditions

- Sensorless vector control (SLVC) is only suitable for asynchronous motors.
- Operation of the sensorless vector control (SLVC) is only permissible for one single drive!
- Operation of the sensorless vector control (SLVC) is **not** permissible for hoists!
- The Lenze setting enables the actuation of a power-adapted motor. Optimum operation requires an identification of the inverter characteristic and the motor parameters. ▶ [Motor data](#) 78

Details

This motor control type is activated by setting **0x2C00 (PAR 300)** = "Sensorless vector control (SLVC) [4]".

In comparison to the V/f characteristic control without feedback, the following can be achieved by means of sensorless vector control SLVC:

- A higher maximum torque throughout the entire speed range
- A higher speed accuracy
- A higher concentricity factor
- A higher level of efficiency
- The implementation of torque-actuated operation with speed limitation
- The limitation of the maximum torque in motor and generator mode for speed-actuated operation

Parameter	Name / value range / [default setting]	Info
0x29C0:001	Field controller settings: Gain 0.00 ... [59.68]* ... 50000.00 A/Vs <ul style="list-style-type: none"> Default setting depending on the size. 	Gain factor Vp of the field controller.



Motor control

Motor control selection

Sensorless vector control (SLVC)

Parameter	Name / value range / [default setting]	Info
0x29C0:002	Field controller settings: Reset time 1.0 ... [45.5]* ... 6000.0 ms • Default setting depending on the size.	Reset time T _n of the field controller.
0x29E0:001	Field weakening controller settings: Gain 0.000 ... [0.000]* ... 2000000.000 Vs/V • Default setting depending on the size.	Gain factor V _p of the field weakening controller.
0x29E0:002	Field weakening controller settings: Reset time 1.0 ... [1478.3]* ... 240000.0 ms • Default setting depending on the size.	Reset time T _n of the field weakening controller.
0x2B40:001	SLVC: Gain 0.0000 ... [0.2686]* ... 1000.0000 Hz/A • Default setting depending on the size.	Gain of the SLVC-Q controller.
0x2B40:002	SLVC: Reset time 1.0 ... [2.3]* ... 2000.0 ms • Default setting depending on the size.	Reset time of the SLVC-Q controller.
0x2900:001 (PAR 332/001)	Speed controller parameters: Gain (Speed controller: Speed contr.: gain) 0.00000 ... [0.00193]* ... 20000.00000 Nm/rpm • Default setting depending on the size.	Gain factor V _p of the speed controller.
0x2900:002 (PAR 332/002)	Speed controller parameters: Reset time (Speed controller: Speed contr.: time) 1.0 ... [80.0]* ... 6000.0 ms • Default setting depending on the size.	Reset time T _i of the speed controller.
0x2915 (PAR 210)	Minimum frequency (Min. frequency) 0.0 ... [0.0] ... 599.0 Hz	Lower limit value for all frequency setpoints.
0x2916 (PAR 211)	Maximum frequency (Max. frequency) 0.0 ... [50.0] ... 599.0 Hz	Upper limit value for all frequency setpoints.
0x2942:001 (PAR 334/001)	Current controller parameters: Gain (Current controller: I-contr.: gain) 0.00 ... [42.55]* ... 750.00 V/A • Default setting depending on the size.	Gain factor V _p of the current controller.
0x2942:002 (PAR 334/002)	Current controller parameters: Reset time (Current controller: I-contr.: time) 0.01 ... [4.50]* ... 2000.00 ms • Default setting depending on the size.	Reset time T _i of the current controller.
0x2BA1:003 (PAR 718/003)	Flying restart circuit: Restart time (Flying restart circuit: Flying restart time) 1 ... [5911]* ... 60000 ms • Default setting depending on the size.	Restart time for flying restart process. • The duration of the flying restart process can be influenced by the setting of the restart time. • A reduction of the restart time causes an accelerated flying restart process and therefore a reduced flying restart duration.
0x6073 (PAR 324)	Max current (Max current) 0.0 ... [200.0] ... 3000.0 %	Maximum overload current of the inverter. • 100 % ≙ rated motor current 0x6075 (PAR 323) • If the current consumption of the motor exceeds this current limit, the inverter changes its dynamic behaviour, in order to counteract this exceedance. • If the change in the dynamic behaviour carried out by the inverter does not result in exiting the overcurrent state, the inverter outputs an error. Note! This parameter is not identical to the so-called ultimate motor current I _{ULT} ! • The ultimate motor current set in 0x2D46:001 (PAR 353/001) is a limit value for synchronous motors that serves to protect their magnets. • The value to be set here should always be considerably below the ultimate motor current!

Motor control

Optimisation of motor control
Voltage boost



7.3 Optimisation of motor control

The inverter provides different functions by means of which the drive behaviour can be further optimised.

7.3.1 Voltage boost

The parameterisable voltage boost makes it possible to improve the starting performance for applications requiring a high starting torque.

Preconditions

"V/f characteristic control (VFC open loop)" motor control has been selected in [0x2C00 \(PAR 300\)](#). Otherwise the voltage boost is not effective.

Parameter	Name / value range / [default setting]	Info
0x2B12:001 (PAR 316/001)	V/f voltage boost: Fixed boost (V/f boosts: V/f boost: stat.) 0.0 ... [2.5]* ... 20.0 % • Default setting depending on the size.	Fixed (constant) voltage boost for V/f characteristic control without feedback. • 100 % \equiv V/f base voltage 0x2B01:001 (PAR 303/001) • For the purpose of optimising the starting performance for applications requiring a high starting torque.
0x2B12:002 (PAR 316/002)	V/f voltage boost: Boost at acceleration (V/f boosts: V/f boost: dyn.) 0.0 ... [0.0] ... 20.0 %	Additional voltage boost for V/f characteristic control without feedback. • 100 % \equiv V/f base voltage 0x2B01:001 (PAR 303/001) • This voltage boost is only active while the motor is accelerated. It then acts in addition to the fixed voltage boost set in 0x2B12:001 (PAR 316/001) .
0x2B01:001 (PAR 303/001)	V/f characteristic data: Base voltage (V/f char. data: Base voltage) 0 ... [230]* ... 5000 V • Default setting depending on the size.	Voltage in the reference point of the V/f characteristic. • The V/f base voltage is usually set to the rated motor voltage 0x2C01:007 (PAR 320/007) .

7.3.2 Skip frequencies

By means of the three parameterisable skip frequencies, critical frequencies can be suppressed which lead to mechanical resonances in the system.

Details

- A skip frequency is active when the skip frequency and the corresponding stop bandwidth are set to a non-zero value.
- The skip frequency defines the centre point of the range to be suppressed, and the stop bandwidth defines its total size. In the case of a skip frequency = 20 Hz and stop bandwidth = 10 Hz, for example the range from 15 Hz to 25 Hz is suppressed.
- Skip frequencies are absolute values. With the setting "20 Hz", at the same time also the skip frequency "-20 Hz" is defined.
- The setting of a range including the frequency "0 Hz" (standstill) is invalid and is therefore ignored.

Parameter	Name / value range / [default setting]	Info
0x291F:001 (PAR 317/001)	Skip frequencies: Frequency 1 (Skip frequencies: Frequency 1) 0.0 ... [0.0] ... 599.0 Hz	Centre of frequency range 1 which is to be hidden.
0x291F:002 (PAR 317/002)	Skip frequencies: Bandwidth 1 (Skip frequencies: Bandwidth 1) 0.0 ... [0.0] ... 10.0 Hz	Size of frequency range 1 which is to be hidden.
0x291F:003 (PAR 317/003)	Skip frequencies: Frequency 2 (Skip frequencies: Frequency 2) 0.0 ... [0.0] ... 599.0 Hz	Centre of frequency range 2 which is to be hidden.
0x291F:004 (PAR 317/004)	Skip frequencies: Bandwidth 2 (Skip frequencies: Bandwidth 2) 0.0 ... [0.0] ... 10.0 Hz	Size of frequency range 2 which is to be hidden.
0x291F:005 (PAR 317/005)	Skip frequencies: Frequency 3 (Skip frequencies: Frequency 3) 0.0 ... [0.0] ... 599.0 Hz	Centre of frequency range 3 which is to be hidden.
0x291F:006 (PAR 317/006)	Skip frequencies: Bandwidth 3 (Skip frequencies: Bandwidth 3) 0.0 ... [0.0] ... 10.0 Hz	Size of frequency range 3 which is to be hidden.



Motor control

Optimisation of motor control

Skip frequencies

Parameter	Name / value range / [default setting]	Info
0x291F:016	Skip frequencies: Status	Bit-coded status display of the skip frequencies.
	• Read only	
	Bit 0 Blocking zone 1 active	
	Bit 1 Blocking zone 2 active	
	Bit 2 Blocking zone 3 active	
	Bit 3 Reserved	
	Bit 4 Frequency above blocking zone 1	
	Bit 5 Frequency above blocking zone 2	
	Bit 6 Frequency above blocking zone 3	
	Bit 7 Reserved	
	Bit 8 Blocking zone 1 invalid	
	Bit 9 Blocking zone 2 invalid	
	Bit 10 Blocking zone 3 invalid	
	Bit 11 Reserved	
Bit 12		
Bit 13		
Bit 14		
Bit 15		
0x291F:032	Skip frequencies: Input frequency	Display of the stop filter input frequency.
• Read only: x.xx Hz		
0x291F:033	Skip frequencies: Output frequency	Display of the stop filter output frequency.
• Read only: x.xx Hz		

Motor control

Optimisation of motor control
Optimising the stalling behaviour



7.3.3 Optimising the stalling behaviour

Motor stalling due to torque overload in the field weakening range in all characteristic-based motor control types (VFCplus) is prevented by means of an inverter-internal stalling current monitoring. In the field weakening range, hence at frequencies above the base frequency, it reduces the maximum current to prevent the motor from stalling. The reduction depends on the current field frequency, the base frequency, the DC-bus voltage, and the maximum current. Generally, a higher field frequency causes a stronger limitation of the maximum current. The response in the field weakening range can be adapted via the override point of field weakening [0x2B0C \(PAR 319\)](#).

⚠ DANGER!

Danger by incorrect parameterisation.

Possible consequences: damage to material assets and injury to persons

- ▶ Only change the Lenze setting (0 Hz) in [0x2B0C \(PAR 319\)](#) after consulting the motor manufacturer!
- ▶ Recommendation: maintain Lenze setting (0 Hz).

Details

With the override point of field weakening [0x2B0C \(PAR 319\)](#), the frequency-dependent maximum current characteristic can be shifted.

Override point of field weakening > 0 Hz:

- The maximum current characteristic is shifted to higher field frequencies by the frequency entered.
- The maximum permissible current and the maximum torque increase in the field weakening range.
- The risk of motor stalling increases.

Override point of field weakening < 0 Hz:

- The maximum current characteristic is shifted to lower field frequencies by the frequency entered.
- The maximum permissible current and the maximum torque are reduced in the field weakening range.
- The risk of motor stalling is reduced.

Parameter	Name / value range / [default setting]	Info
0x2B0C (PAR 319)	Override point of field weakening (<i>Overr. point of field weak.</i>) -599.0 ... [0.0] ... 599.0 Hz	Offset of the override point for field weakening.
0x2B01:002 (PAR 303/002)	V/f characteristic data: Base frequency (<i>V/f char. data: Base frequency</i>) 0 ... [50]* ... 599 Hz • Default setting depending on the size.	Frequency in the reference point of the V/f characteristic. • The V/f base frequency is usually set to the rated motor frequency 0x2C01:005 (PAR 320/005) .



7.3.4 Slip compensation

Slip compensation serves to automatically compensate for a load-dependent speed loss.

Preconditions

In order that the slip compensation can determine the rated slip correctly, the following parameters must be set correctly:

- Rated speed
- Rated frequency
- Number of pole pairs (automatically calculated from Rated speed and Rated frequency)

Parameter	Name / value range / [default setting]	Info
0x2B09:001 (PAR 315/001)	Slip compensation: Gain (Slip compens.: Slip: gain) -200.00 ... [100.00] ... 200.00 %	Adjustment in percent of the slip calculated. <ul style="list-style-type: none"> • For instance required for deviations of the real motor data from the nameplate data. • A setting of 100 % corresponds to the rated slip of the machine in the nominal operating point.
0x2B09:002 (PAR 315/002)	Slip compensation: Filter time (Slip compens.: Filter time) 1 ... [5] ... 6000 ms	
0x2C02:004 (PAR 351/004)	Motor parameter (ASM): Slip frequency (ASM motor par.: ASM slip freq.) <ul style="list-style-type: none"> • Read only: x.x Hz 	Display of the rated slip determined.
0x2C01:001	Motor parameters: Number of pole pairs <ul style="list-style-type: none"> • Read only 	Display of the number of pole pairs calculated from the rated speed and rated frequency.
0x2C01:004 (PAR 320/004)	Motor parameters: Rated speed (Motor parameters: Mot. speed) 50 ... [1450] ... 50000 rpm	General motor parameters. Carry out settings as specified by motor nameplate data.
0x2C01:005 (PAR 320/005)	Motor parameters: Rated frequency (Motor parameters: Mot. frequency) 1.0 ... [50.0] ... 1000.0 Hz	

Motor control

Optimisation of motor control
Oscillation damping



7.3.5 Oscillation damping

The oscillation damping serves to reduce the oscillations during no-load operation which are caused by energy oscillating between the mechanical system (mass inertia) and the electrical system (DC bus). Furthermore, the oscillation damping can also be used to compensate for resonances.

Preconditions

"V/f characteristic control (VFC open loop)" motor control has been selected in [0x2C00 \(PAR 300\)](#). Otherwise the oscillation damping is not effective.

Restrictions

Observe the following restrictions:

- Damping is possible only for constant oscillations at a steady-state operating point.
- Oscillations occurring sporadically cannot be damped.
- Oscillation damping is not suitable for oscillations occurring during dynamic processes (e.g. accelerations or load changes).
- Oscillation damping is only active if the setpoint speed is greater than 10 rpm and the DC-bus voltage exceeds a value of 100 V.

Details

The determination of the oscillation is based on the active current. In order to obtain the alternating component of the active current, this current is differentiated. This signal is then passed through a PT1 filter.

Identification of the oscillation

Before the oscillation damping function can be parameterised, the oscillation has to be identified. One way to do this is to examine the motor current while oscillation damping is switched off (gain = 0 %). At steady-state operation, a constant current flows. If the drive oscillates, these oscillations are also visible on the motor current. It is therefore possible to determine the frequency and the amplitude of the oscillation from the alternating component of the motor current. In the following, this alternating component is referred to as "current oscillation".

Parameter setting

The gain of the oscillation signal is to be set according to the following equation:

$$0x2B0A:001 \text{ (PAR 318/001)} = \text{current amplitude} * 100 \% / (\sqrt{2} * \text{maximum device current})$$

The default time constant of the PT1 filter should be sufficient for most applications. If required, it is only possible to adapt the time constant via »EASY Starter«. Generally, the time constant must be set so that the oscillation can be dampened, but that higher-frequency components are filtered from the signal. The time constant is determined from the reciprocal value of the double current oscillation frequency:

$$0x2B0A:002 \text{ (PAR 318/002)} = 1 / (2 * \text{oscillation frequency})$$

Parameter	Name / value range / [default setting]	Info
0x2B0A:001 (PAR 318/001)	Oscillation damping: Gain (Oscillation damping: Oscillation: gain) -100 ... [20] ... 100 %	Gain of the oscillation signal. <ul style="list-style-type: none">• With the setting 0, oscillation damping is deactivated.
0x2B0A:002 (PAR 318/002)	Oscillation damping: Filter time (Oscillation damping: Oscillation: time) 1 ... [5] ... 600 ms	Time constant of the PT1 filter.
0x2DDF:002	Axis information: Maximum current <ul style="list-style-type: none">• Read only: x.xx A• Default setting depending on the size.	Display of the maximum current of the axis.
0x2D88 (PAR 104)	Actual motor current (Act. motor current) <ul style="list-style-type: none">• Read only: x.x A	Display des present current-r.m.s. value.



7.4 Optimisation of the control loops

The following speed controller, I_{max} controller and current controller parameters are calculated and set automatically and in the course of the automatic calibration of the motor.

Details

- The calibration process can be carried out in "energised" or in "non-energised" mode.
- The calibration process takes all controllers into consideration at the same time; it is not possible to control the speed controller I_{max} controller, and current controller separately.
- Without carrying out the calibration, standard values are preset according to the voltage and power of the inverter.
- When the automatic calibration has been carried out, further adaptation is neither required nor recommended for typical applications.



If these parameters have to be adapted, this has to be done very carefully. An incorrect setting may have a negative impact on the control system.

7.4.1 Speed controller

Parameter	Name / value range / [default setting]	Info
0x2900:001 (PAR 332/001)	Speed controller parameters: Gain (Speed controller: Speed contr.: gain) 0.00000 ... [0.00193]* ... 20000.00000 Nm/rpm • Default setting depending on the size.	Gain factor V _p of the speed controller.
0x2900:002 (PAR 332/002)	Speed controller parameters: Reset time (Speed controller: Speed contr.: time) 1.0 ... [80.0]* ... 6000.0 ms • Default setting depending on the size.	Reset time T _i of the speed controller.
0x2904	Filter time 0.0 ... [2.0] ... 50.0 ms	Filter time for the actual speed value.

7.4.2 I_{max} controller

Parameter	Name / value range / [default setting]	Info
0x2B08:001 (PAR 333/001)	V/f I _{max} controller: Gain (V/f I _{max} controller: I _{max} ctrlrler: gain) 0.000 ... [0.284]* ... 1000.000 Hz/A • Default setting depending on the size.	Gain factor V _p of the I _{max} controller.
0x2B08:002 (PAR 333/002)	V/f I _{max} controller: Reset time (V/f I _{max} controller: I _{max} ctrlrler: time) 1.0 ... [2.3]* ... 2000.0 ms • Default setting depending on the size.	Reset time T _i of the I _{max} controller.

7.4.3 Current controller

Parameter	Name / value range / [default setting]	Info
0x2942:001 (PAR 334/001)	Current controller parameters: Gain (Current controller: I-contr.: gain) 0.00 ... [42.55]* ... 750.00 V/A • Default setting depending on the size.	Gain factor V _p of the current controller.
0x2942:002 (PAR 334/002)	Current controller parameters: Reset time (Current controller: I-contr.: time) 0.01 ... [4.50]* ... 2000.00 ms • Default setting depending on the size.	Reset time T _i of the current controller.



7.5 Motor rotating direction

Parameter	Name / value range / [default setting]	Info
0x283A (PAR 304)	Limitation of rotation (Rotation mode)	Optional restriction of the rotating direction.
	0 Only forwards	The motor can only be traversed in forward direction, since the transfer of negative frequency and process controller setpoints to the motor control is avoided. <ul style="list-style-type: none"> This function takes effect after the "Reversal" function (0x2631:013 (PAR 400/013)). Since this function only avoids negative setpoints, traversing in backward direction is possible if the motor has been wired for this rotating direction.
	1 Forwards and backwards	The motor can be traversed in both directions.
0x2631:013 (PAR 400/013)	Function assignment: Reversal (Function list: Reversal of rot. dir.) <ul style="list-style-type: none"> Setting can only be changed if controller inhibit is active. For possible settings see description for 0x2631:001 (PAR 400/001). 188 	Assignment of a trigger for the "Reversal" function. Trigger = TRUE: the setpoint specified is inverted (i. e. the sign is inverted). Trigger = FALSE: no action / deactivate function again.
	13 Digital input 3	State of X3/DI3, taking an inversion set in 0x2632:003 (PAR 411/003) into consideration.



7.6 Switching frequency changeover

The switching frequency of the inverter has an impact on the smooth running performance and the noise generation in the motor connected as well as on the power loss in the inverter. The lower the switching frequency, the better the concentricity factor, the smaller the power loss and the higher the noise generation.

Parameter	Name / value range / [default setting]	Info
0x2939 (PAR 305)	Switching frequency (Switching frequency)	Selection of the inverter switching frequency. Abbreviations used: <ul style="list-style-type: none"> • "Variable": adaptation of the switching frequency as a function of the current • "Drive-opt.": drive-optimised modulation ("sine/delta modulation") • "Fixed": fixed switching frequency • "Min. Pv": additional reduction of power loss
	1 4 kHz variable / drive-optimised	
	2 8 kHz variable / drive-optimised	
	3 16 kHz variable / drive-optimised	
	5 2 kHz fixed / drive-optimised	
	6 4 kHz fixed / drive-optimised	
	7 8 kHz fixed / drive-optimised	
	8 16 kHz fixed / drive-optimised	
	11 4 kHz variable / min. Pv	
	12 8 kHz variable / min. Pv	
	13 16 kHz variable / min. Pv	
	15 2 kHz constant/min. Pv	
	16 4 kHz constant/min. Pv	
	17 8 kHz constant/min. Pv	
	18 16 kHz constant/min. Pv	
	21 8 kHz variable / drive-optimised / 4 kHz min.	
	22 16 kHz variable / drive-optimised / 4 kHz min.	
23 16 kHz variable / drive-optimised / 8 kHz min.		
31 8 kHz variable /min. Pv / 4 kHz min.		
32 16 kHz variable /min. Pv / 4 kHz min.		
33 16 kHz variable /min. Pv / 8 kHz min.		

Motor control

Motor protection
Motor overload monitoring ($i^2 \cdot t$)



7.7 Motor protection

- Motor overload monitoring ($i^2 \cdot t$) [92](#)
- Current limits [93](#)
- Ultimate motor current [94](#)
- Motor phase failure detection [94](#)
- Motor speed monitoring [95](#)

7.7.1 Motor overload monitoring ($i^2 \cdot t$)

This function monitors the thermal utilisation of the motor, taking the motor currents recorded and a mathematical model as a basis.

DANGER!

Fire hazard by overheating of the motor.

Possible consequences: Death or severe injuries

- ▶ To achieve full motor protection, an additional temperature monitoring function with a separate evaluation must be installed.
- ▶ When actuating motors that are equipped with PTC thermistors or thermal contacts, always activate the PTC input.

Details

This function only serves to functionally protect the motor. It is not suitable for the safety-relevant protection against energy-induced hazards, since the implementation is not fail-safe.

- When the thermal motor utilisation calculated reaches the threshold set in [0x2D4B:001 \(PAR 308/001\)](#), the response set in [0x2D4B:003 \(PAR 308/003\)](#) is triggered.
- With the setting [0x2D4B:003 \(PAR 308/003\)](#) = "No response [0]", the monitoring function is deactivated.



To ensure a UL-compliant operation, [0x2D4B:002 \(PAR 308/002\)](#) and [0x2D4B:003 \(PAR 308/003\)](#) have to be left to Lenze setting! (speed compensation = "On [0]" and error response = "error [3]").

Parameter	Name / value range / [default setting]	Info
0x2D4B:001 (PAR 308/001)	Motor overload monitoring ($i^2 \cdot t$): Maximum utilisation [60 s] (Motor overload: Load at 60 sec) 30 ... [150] ... 200 %	Maximum permissible thermal motor utilisation (max. permissible motor current for 60 seconds). <ul style="list-style-type: none"> • 100 % \equiv rated motor current 0x6075 (PAR 323) • If the motor is actuated with the current set here for 60 seconds, the maximum permissible thermal motor utilisation is reached and the response set in 0x2D4B:003 (PAR 308/003) is executed. • If the motor is actuated with a different current, the time period until the motor overload monitoring function is activated is different. Generally the following applies: the lower the current, the lower the thermal utilisation and the later the monitoring function is triggered.
0x2D4B:002 (PAR 308/002)	Motor overload monitoring ($i^2 \cdot t$): Speed compensation (Motor overload: Speed comp.)	Use this function to protect motors that are actuated at a speed below 40 Hz. <ul style="list-style-type: none"> • UL-compliant operation requires the setting "On [0]"!
	0 On	Release time for motor overload monitoring is reduced in order to compensate for the reduced cooling of naturally ventilated AC induction motors during operation at low speed.
	1 Off	Function deactivated, no reduction of the motor overload monitoring release time.
0x2D4B:003 (PAR 308/003)	Motor overload monitoring ($i^2 \cdot t$): Error response (Motor overload: Error response) <ul style="list-style-type: none"> • For possible settings see description for 0x2D45:001 (PAR 310/001). 94 	Selection of the response to the triggering of motor overload monitoring. <ul style="list-style-type: none"> • UL-compliant operation requires the setting "Error [3]"!
	3 Error	



Parameter	Name / value range / [default setting]	Info
0x2D4B:005	Motor overload monitoring ($i^2 \cdot t$): Thermal load <ul style="list-style-type: none"> Read only 	

7.7.2 Current limits

For the purpose of current limitation, a maximum overload current can be set for the inverter. If the current consumption of the motor exceeds this current limit, the inverter changes its dynamic behaviour, in order to counteract this exceedance.

Details



If the change in the dynamic behaviour carried out by the inverter does not result in exiting the overcurrent state, the inverter outputs an error.

Overload during acceleration in motor mode

- The inverter prolongs the acceleration ramp to keep the current on or below the current limit.
- A longer time than is required for reaching the frequency setpoint is set.

Overload during deceleration in generator mode

- The inverter prolongs the deceleration ramp to keep the current on or below the current limit.
- A longer time than is required for reaching standstill is set.

Increasing load with a constant frequency

- If the motor current limit value is reached:
 - The inverter reduces the effective speed setpoint until a stable working point is set or an effective speed setpoint of 0 min^{-1} is reached.
 - If the load is reduced, the inverter increases the effective speed setpoint until the setpoint speed is reached or the load reaches the current limit value again.
- When the generator current limit value is reached:
 - The inverter increases the effective speed setpoint until a stable working point is reached or up to the maximum permissible output frequency [0x2916 \(PAR 211\)](#).
 - If the load is reduced, the inverter reduces the effective speed setpoint until the setpoint speed is reached or the load reaches the current limit value again.
- If an abrupt load is building at the motor shaft (e.g. drive is blocked), the overcurrent switch-off function may respond.

Parameter	Name / value range / [default setting]	Info
0x6073 (PAR 324)	Max current (Max current) 0.0 ... [200.0] ... 3000.0 %	Maximum overload current of the inverter. <ul style="list-style-type: none"> 100 % \equiv rated motor current 0x6075 (PAR 323) If the current consumption of the motor exceeds this current limit, the inverter changes its dynamic behaviour, in order to counteract this exceedance. If the change in the dynamic behaviour carried out by the inverter does not result in exiting the overcurrent state, the inverter outputs an error. Note! This parameter is not identical to the so-called ultimate motor current I_{ULT} ! <ul style="list-style-type: none"> The ultimate motor current set in 0x2D46:001 (PAR 353/001) is a limit value for synchronous motors that serves to protect their magnets. The value to be set here should always be considerably below the ultimate motor current!
0x2D88 (PAR 104)	Actual motor current (Act. motor current) <ul style="list-style-type: none">Read only: x.x A	Display des present current-r.m.s. value.

Motor control

Motor protection
Ultimate motor current



Parameter	Name / value range / [default setting]	Info
0x6078 (PAR 103)	Current actual value (Motor current %) • Read only: x.x %	Display of the present motor current. • 100 % ≙ rated motor current 0x6075 (PAR 323)

7.7.3 Ultimate motor current

The parameterisable ultimate motor current I_{ULT} serves to protect the motor.

i NOTICE!

With an incorrect parameterisation, the ultimate motor current may be exceeded in the process.

Possible consequence: irreversible damage of the motor.

- ▶ Be absolutely sure to adapt the setting of the ultimate motor current to the motor connected.
- ▶ Set the maximum output current of the inverter in 0x6073 (PAR 324) to a considerably lower value than that of the ultimate motor current.

Parameter	Name / value range / [default setting]	Info
0x2D46:001 (PAR 353/001)	Monitoring of ultimate motor current: Threshold (Ult mot. current monit.: Mot. current threshold) 0.0 ... [6.8]* ... 500.0 A • Default setting depending on the size.	Warning/error threshold for motor current monitoring. • If the instantaneous value of the motor current exceeds the threshold set, the response set in 0x2D46:002 (PAR 353/002) is effected for the purpose of motor protection.
0x2D46:002 (PAR 353/002)	Monitoring of ultimate motor current: Response (Ult mot. current monit.: Mot. current resp.) • For possible settings see description for 0x2D45:001 (PAR 310/001). □ 94	Selection of the response to the triggering of motor current monitoring.
	3 Error	

7.7.4 Motor phase failure detection

The motor phase failure detection function can be activated for both synchronous and asynchronous motors.

Preconditions

Phase failure detection during operation is basically only suitable for applications which are operated with a constant load and speed. In all other cases, transient processes or unfavourable operating points can cause maloperation.

Details

If a current-carrying motor phase (U, V, W) fails during operation, the response selected in 0x2D45:001 (PAR 310/001) is tripped if the following two conditions are met:

- Condition 1: detection is activated. See 0x2D45:002 (PAR 310/002)
- Condition 2: a specific commutation angle (approx. 150° electrically) has been covered without the detection of a current flow.

Parameter	Name / value range / [default setting]	Info
0x2D45:001 (PAR 310/001)	Motor phase failure detection: Response (Motor \emptyset failure: \emptyset error response)	Selection of the response following the detection of a motor phase failure.
	0 No response	
	1 Warning	
	2 Trouble	
	3 Error	



Parameter	Name / value range / [default setting]	Info
0x2D45:002 (PAR 310/002)	Motor phase failure detection: Current threshold (Motor \emptyset failure: \emptyset error current) 1.0 ... [5.0] ... 10.0 %	Current threshold for the activation of the motor phase failure detection function. <ul style="list-style-type: none"> 100 % \equiv Maximum current 0x2DDF:002 Background: in order to be able to reliably detect the failure of a motor phase, first a certain must flow for the current sensor system. The detection function is therefore only activated if the actual value of the motor current has exceeded the current threshold set here. Display of actual value for the motor current in 0x6078 (PAR 103).
0x2D45:003 (PAR 310/003)	Motor phase failure detection: Voltage threshold (Motor \emptyset failure: \emptyset error volt.) 0.0 ... [10.0] ... 100.0 V	Voltage threshold for the monitoring of several motor phases. <ul style="list-style-type: none"> The V/f characteristic control enables the detection of several failed motor phases during operation. Monitoring with regard to the failure of several motor phases is active if a response that is not "0: No response" is set in 0x2D45:001 (PAR 310/001) and if the motor voltage exceeds the voltage threshold set here. The monitoring function is triggered if the level of the motor current is lower than the device-dependent threshold for longer than 20 ms. The monitoring function for the failure of several motor phases can be deactivated if the value "100.0 V" is set here.

7.7.5 Motor speed monitoring

Use this function to monitor the motor speed during running operation.

Preconditions

In order to record the current motor speed, the drive must run and the motor must rotate.

Parameter	Name / value range / [default setting]	Info
0x2D44:001 (PAR 350/001)	Overspeed monitoring: Threshold (Overspeed monit.: Overspeed: threshold) 50 ... [8000] ... 50000 rpm	Warning/error threshold for motor speed monitoring. <ul style="list-style-type: none"> If the motor speed reaches the threshold set, the response selected in 0x2D44:002 (PAR 350/002) is effected.
0x2D44:002 (PAR 350/002)	Overspeed monitoring: Response (Overspeed monit.: Overspeed: response) <ul style="list-style-type: none"> For possible settings see description for 0x2D45:001 (PAR 310/001). 📖 94 	Selection of the response to the triggering of motor speed monitoring.
	3 Error	

Configuring the network

Motor protection
Motor speed monitoring



8 Configuring the network

The inverter is available in a version with CANopen and Modbus network option.



8.1 General network settings

Checking the network option

At switch-on, the inverter checks whether the parameter settings saved in the memory module match the network option available in the control unit. If this is not the case, the inverter assumes the error status. The error status can only be exited by accepting the currently available network option as new hardware. For this purpose, [0x2022:027 \(PAR 700/027\)](#) must be set to "1". When this device command is executed, all parameters for the new network option are initialised.

Diagnostic parameters:

- The network option currently configured in the inverter is displayed in [0x231F:001 \(PAR 500/001\)](#).
- The network option currently available in the inverter is displayed in [0x231F:002 \(PAR 500/002\)](#).

Enabling the network as control source

In order to be able to control the inverter via network, a trigger must first be assigned in [0x2631:037 \(PAR 400/037\)](#) of the "Network enable" function. This trigger can for instance be the constant value "TRUE" or a digital input. If the trigger assigned is TRUE, the inverter changes to the network control mode. The inverter now responds to the start and stop commands received via network.

In network control mode the following functions are still active:

- [0x2631:001 \(PAR 400/001\)](#): Controller enable
- [0x2631:002 \(PAR 400/002\)](#): Start enable
- [0x2631:003 \(PAR 400/003\)](#): Quick stop
- [0x2631:004 \(PAR 400/004\)](#): Reset error
- [0x2631:005 \(PAR 400/005\)](#): DC braking
- [0x2631:037 \(PAR 400/037\)](#): Network enable

All other functions that can be configured via [0x2631 \(PAR 400\)](#) are deactivated in network control mode.

Network control word and status word

For establishing a simple network connection, the inverter provides predefined control and status words for device profile CiA402, AC drive profile as well as in LECOM format. By means of data mapping to a network register, each of these words can be transferred as process data via network.

For the assignment of the predefined control and status words see the following chapters:

- [Device profile CiA402. !\[\]\(c045a398c48fcb47adf237d338b1b391_img.jpg\) 105](#)
- [AC Drive Profile. !\[\]\(6ea471090ba6b2c70129dc83eb6e6a11_img.jpg\) 106](#)
- [Lenze LECOM profile. !\[\]\(943b1c41f252b081e01aba2e7830f1c9_img.jpg\) 107](#)

If an individual control word format is to be implemented, the NETwordIN1 data word is provided for this purpose.

- The NETwordIN1 data word features the mapping address [0x40080100 \(index 0x4008:001\)](#).
- The functions which are to be triggered via bits 1 ... 16 of the NETwordIN1 data word are defined in [0x400E:001 \(PAR 505/001\)](#).

If an individual status word format is to be implemented, the NETwordOUT1 data word is provided for this purpose.

- The NETwordOUT1 data word features the mapping address [0x400A0100 \(index 0x400A:001\)](#).
- The trigger for bits 1 ... 16 of the NETwordOUT1 data word is defined in [0x2634:010 \(PAR 420/010\) ... 0x2634:025 \(PAR 420/025\)](#).

General information about the process of data mapping can be found in the chapter of the same name for the corresponding network.

Configuring the network

General network settings



Network setpoint

- In order to generally set the network as standard setpoint source, go to [0x2860:001 \(PAR 201/001\)](#) and select "Network [5]".
- If a bit of the mappable NETWordIN1 data word is to be used for activation, use [0x400E:001 \(PAR 505/001\)](#) to assign the function "Setpoint = Network [17]" to the corresponding bit of NETWordIN1.
- There is no specific function with a selectable trigger for a setpoint change-over to the network.

Parameter	Name / value range / [default setting]	Info	
0x231F:001 (PAR 500/001)	Module ID: Active module ID (Module ID: Active module ID)	Display of the network options currently configured in the inverter. <ul style="list-style-type: none"> • When the "Load Lenze settings" device command 0x2022:001 (PAR 700/001) or "Accept new inverter hardware" 0x2022:027 (PAR 700/027) is executed, the module ID is stored in the memory module. • With the help of this module ID, the keypad only shows the communication parameters relevant to the respective network. 	
	• Read only		
	• Default setting depending on the size.		
	0 No network		
	67 CANopen		
0x231F:002 (PAR 500/002)	Module ID: Module ID connected (Module ID: Module ID conn.)	Display of the network options currently connected in the inverter.	
	• Read only		
	0 No network		
	67 CANopen		
	80 PROFIBUS		
0x400E:001 (PAR 505/001)	NETWordIN1 function assignment: Bit 0 (NETWordIN1 config.: NETWordIN1.00)	Definition of the function that is to be triggered via bit 0 of the mappable NETWordIN1 data word.	
	• Setting can only be changed if controller inhibit is active.		
	0 Not active		Trigger bit without any function.
	1 Controller inhibit		Trigger bit = 0-1 edge: The inverter is inhibited. Starting the drive is not possible. Trigger bit = 0: The inverter is enabled (unless there is another cause for controller inhibit). Notes: <ul style="list-style-type: none"> • In all device states, a 0-1 edge causes an immediate change to the inhibited state with one exception: If the inverter is in the error status and the error condition still exists, the inverter remains in the error status. • Changing to the inhibited state causes an immediate stop of the drive, regardless of the stop method set in 0x2838:003 (PAR 203/003). The drive coasts down as a function of the mass inertia of the machine. • After deactivating the controller inhibit, a new start command is required to restart the drive. • The causes that are active for controller inhibit are shown in 0x282A:001 (PAR 126/001).
	2 Stop		Trigger bit = 1: Drive is stopped. Trigger bit = 0: No action / Deactivate stop again. Notes: <ul style="list-style-type: none"> • The stop method can be selected in 0x2838:003 (PAR 203/003).
3 Quick stop	Trigger bit = 1: "Quick stop" function activated. Trigger bit = 0: no action / deactivate function again. Notes: <ul style="list-style-type: none"> • The "Quick stop" function brings the motor to a standstill within the deceleration time set in 0x291C (PAR 225). • The "Quick stop" function has a higher priority than the "Start enable" function. 		



Configuring the network

General network settings

Parameter	Name / value range / [default setting]	Info
	4 Reset error	<p>Trigger bit = 0-1 edge: active error is reset (acknowledged) if the error cause has been eliminated.</p> <p>Trigger bit = 0: no action.</p> <p>Notes:</p> <ul style="list-style-type: none"> After resetting the error, a new enable/start command is required to restart the drive.
	5 DC braking	<p>Trigger bit = 1: "DC braking" function activated.</p> <p>Trigger bit = 0: no action / deactivate function again.</p>
	8 Forward run (CW)	<p>Trigger bit = 0-1 edge: drive is started in forward rotating direction (CW).</p> <p>Trigger bit = 1-0 edge: drive is stopped again.</p> <p>Notes:</p> <ul style="list-style-type: none"> In order to start the drive with this function, the "Stop [2]" function has to be assigned to a bit in order to provide a stop command. The stop method can be selected in 0x2838:003 (PAR 203/003). In the case of a bipolar setpoint selection (e.g. ± 10 V), the function is executed irrespective of the rotating direction. The rotating direction is determined by the sign of the setpoint. The function also serves to realise an automatic start after switch-on. <ul style="list-style-type: none"> ▶ Starting performance □ 72 The "Reversal [13]" function can be used in connection with this function.
	9 Backward run (CCW)	<p>Trigger bit = 0-1 edge: drive is started in backward rotating direction (CCW).</p> <p>Trigger bit = 1-0 edge: drive is stopped again.</p> <p>Notes:</p> <ul style="list-style-type: none"> In order to start the drive with the function, the "Stop [2]" function has to be assigned to a bit in order to provide a stop command. The stop method can be selected in 0x2838:003 (PAR 203/003). In the case of a bipolar setpoint selection (e.g. ± 10 V), the function is executed irrespective of the rotating direction. The rotating direction is determined by the sign of the setpoint. The function also serves to realise an automatic start after switch-on. <ul style="list-style-type: none"> ▶ Starting performance □ 72 The "Reversal [13]" function can be used in connection with this function.
	13 Reversal	<p>Trigger bit = 1: the setpoint specified is inverted (i. e. the sign is inverted).</p> <p>Trigger bit = 0: no action / deactivate function again.</p>
	14 Setpoint = AI1	<p>Trigger bit = 1: analog input 1 is used as setpoint source (if the trigger bit assigned has the highest setpoint priority).</p> <p>Trigger bit = 0: no action / deactivate function again.</p>
	15 Setpoint = AI2	<p>Trigger bit = 1: analog input 2 is used as setpoint source (if the trigger bit assigned has the highest setpoint priority).</p> <p>Trigger bit = 0: no action / deactivate function again.</p>
	17 Setpoint = Network	<p>Trigger bit = 1: the network is used as setpoint source (if the trigger bit assigned has the highest setpoint priority).</p> <p>Trigger bit = 0: no action / deactivate function again.</p>
	18 Preset val. selection bit 0	<p>Selection bit with the valency 2^0 for the bit-coded selection and activation of a parameterisable setpoint (preset value).</p>
	19 Preset val. selection bit 1	<p>Selection bit with the valency 2^1 for the bit-coded selection and activation of a parameterisable setpoint (preset value).</p>
	20 Preset val. selection bit 2	<p>Selection bit with the valency 2^2 for the bit-coded selection and activation of a parameterisable setpoint (preset value).</p>
	21 Preset val. selection bit 3	<p>Selection bit with the valency 2^3 for the bit-coded selection and activation of a parameterisable setpoint (preset value).</p>
	39 Activation of ramp 2	<p>Trigger bit = 1: activate acceleration time 2 and deceleration time 2 manually.</p> <p>Trigger bit = 0: no action / deactivate function again.</p>

Configuring the network

General network settings



Parameter	Name / value range / [default setting]	Info
	40 Load parameter set	Trigger bit = 0-1 edge: parameter change-over to the value set selected via "Parameter set selection bit 0" and "Parameter set selection bit 1". Trigger bit = 0: no action. Notes: <ul style="list-style-type: none"> The activation method for the "Parameter change-over" function can be selected in 0x4046 (PAR 755).
	41 Parameter set selection bit 0	Selection bit with the valency 2^0 for "Parameter change-over" function.
	42 Parameter set selection bit 1	Selection bit with the valency 2^1 for "Parameter change-over" function.
	43 User-defined fault 1	Trigger bit = 1: trigger user-defined fault 1. Trigger bit = 0: no action. Notes: <ul style="list-style-type: none"> When the fault has been triggered, the inverter changes to the "Fault" state. After resetting the fault, a new enable/start command is required to restart the drive.
	44 User-defined fault 2	Trigger bit = 1: trigger user-defined fault 2. Trigger bit = 0: no action. Notes: <ul style="list-style-type: none"> When the fault has been triggered, the inverter changes to the "Fault" state. After resetting the fault, a new enable/start command is required to restart the drive.
	45 Process controller off	Trigger bit = 1: if process controller mode is active, ignore PID control and actuate the drive in speed-controlled manner. Trigger bit = 0: if process controller mode is active, actuate the drive with PID control. Notes: <ul style="list-style-type: none"> PID control can be selected in 0x4020:001 (PAR 600/001).
	46 Set process controller output to 0	Trigger bit = 1: if process controller mode is active, the I component and the output of the process controller are set to 0 and the internal control algorithm is stopped. Process controller mode remains active. Trigger bit = 0: no action / deactivate function again.
	47 Inhibit process controller I-component	Trigger bit = 1: if process controller mode is active, the I component of the process controller is set to 0 and the integration process is stopped. Trigger bit = 0: no action / deactivate function again. Notes: <ul style="list-style-type: none"> The reset time can be set in 0x4049 (PAR 602).
	48 Activate process controller influence ramp	Trigger bit = 1: the influence of the process controller is shown by means of a ramp. Trigger bit = 0 or not connected: the influence of the process controller is shown by means of a ramp. Notes: <ul style="list-style-type: none"> The influence of the process controller is always active (not only in process controller mode). Acceleration time for showing the influence of the process controller can be set in 0x404C:001 (PAR 607/001). Deceleration time for hiding the influence of the process controller can be set in 0x404C:002 (PAR 607/002).
0x400E:002 (PAR 505/002)	NETWordIN1 function assignment: Bit 1 (NETWordIN1 config.: NETWordIN1.01) <ul style="list-style-type: none"> Setting can only be changed if controller inhibit is active. For possible settings see description for 0x400E:001 (PAR 505/001). □ 98 	Definition of the function that is to be triggered via bit 1 of the mappable NETWordIN1 data word.
	00 Not active	Trigger bit without any function.



Configuring the network

General network settings

Parameter	Name / value range / [default setting]	Info
0x400E:003 (PAR 505/003)	NETWordIN1 function assignment: Bit 2 (NETWordIN1 config.: NETWordIN1.02) <ul style="list-style-type: none"> Setting can only be changed if controller inhibit is active. For possible settings see description for 0x400E:001 (PAR 505/001). □ 98 	Definition of the function that is to be triggered via bit 2 of the mappable NETWordIN1 data word.
	03 Quick stop	Trigger bit = 1: "Quick stop" function activated. Trigger bit = 0: no action / deactivate function again. Notes: <ul style="list-style-type: none"> The "Quick stop" function brings the motor to a standstill within the deceleration time set in 0x291C (PAR 225). The "Quick stop" function has a higher priority than the "Start enable" function.
0x400E:004 (PAR 505/004)	NETWordIN1 function assignment: Bit 3 (NETWordIN1 config.: NETWordIN1.03) <ul style="list-style-type: none"> Setting can only be changed if controller inhibit is active. For possible settings see description for 0x400E:001 (PAR 505/001). □ 98 	Definition of the function that is to be triggered via bit 3 of the mappable NETWordIN1 data word.
	8 Forward run (CW)	Trigger bit = 0-1 edge: drive is started in forward rotating direction (CW). Trigger bit = 1-0 edge: drive is stopped again. Notes: <ul style="list-style-type: none"> In order to start the drive with this function, the "Stop [2]" function has to be assigned to a bit in order to provide a stop command. The stop method can be selected in 0x2838:003 (PAR 203/003). In the case of a bipolar setpoint selection (e.g. ±10 V), the function is executed irrespective of the rotating direction. The rotating direction is determined by the sign of the setpoint. The function also serves to realise an automatic start after switch-on. ▶ Starting performance □ 72 The "Reversal [13]" function can be used in connection with this function.
0x400E:005 (PAR 505/005)	NETWordIN1 function assignment: Bit 4 (NETWordIN1 config.: NETWordIN1.04) <ul style="list-style-type: none"> Setting can only be changed if controller inhibit is active. For possible settings see description for 0x400E:001 (PAR 505/001). □ 98 	Definition of the function that is to be triggered via bit 4 of the mappable NETWordIN1 data word.
	13 Reversal	Trigger bit = 1: the setpoint specified is inverted (i. e. the sign is inverted). Trigger bit = 0: no action / deactivate function again.
0x400E:006 (PAR 505/006)	NETWordIN1 function assignment: Bit 5 (NETWordIN1 config.: NETWordIN1.05) <ul style="list-style-type: none"> Setting can only be changed if controller inhibit is active. For possible settings see description for 0x400E:001 (PAR 505/001). □ 98 	Definition of the function that is to be triggered via bit 5 of the mappable NETWordIN1 data word.
	05 DC braking	Trigger bit = 1: "DC braking" function activated. Trigger bit = 0: no action / deactivate function again.
0x400E:007 (PAR 505/007)	NETWordIN1 function assignment: Bit 6 (NETWordIN1 config.: NETWordIN1.06) <ul style="list-style-type: none"> Setting can only be changed if controller inhibit is active. For possible settings see description for 0x400E:001 (PAR 505/001). □ 98 	Definition of the function that is to be triggered via bit 6 of the mappable NETWordIN1 data word.
	00 Not active	Trigger bit without any function.

Configuring the network

General network settings



Parameter	Name / value range / [default setting]	Info
0x400E:008 (PAR 505/008)	NETWordIN1 function assignment: Bit 7 (NETWordIN1 config.: NETWordIN1.07) <ul style="list-style-type: none"> Setting can only be changed if controller inhibit is active. For possible settings see description for 0x400E:001 (PAR 505/001). □98 	Definition of the function that is to be triggered via bit 7 of the mappable NETWordIN1 data word.
	04 Reset error	Trigger bit = 0-1 edge: active error is reset (acknowledged) if the error cause has been eliminated. Trigger bit = 0: no action. Notes: <ul style="list-style-type: none"> After resetting the error, a new enable/start command is required to restart the drive.
0x400E:009 (PAR 505/009)	NETWordIN1 function assignment: Bit 8 (NETWordIN1 config.: NETWordIN1.08) <ul style="list-style-type: none"> Setting can only be changed if controller inhibit is active. For possible settings see description for 0x400E:001 (PAR 505/001). □98 	Definition of the function that is to be triggered via bit 8 of the mappable NETWordIN1 data word.
	18 Preset val. selection bit 0	Selection bit with the valency 2 ⁰ for the bit-coded selection and activation of a parameterisable setpoint (preset value).
0x400E:010 (PAR 505/010)	NETWordIN1 function assignment: Bit 9 (NETWordIN1 config.: NETWordIN1.09) <ul style="list-style-type: none"> Setting can only be changed if controller inhibit is active. For possible settings see description for 0x400E:001 (PAR 505/001). □98 	Definition of the function that is to be triggered via bit 9 of the mappable NETWordIN1 data word.
	19 Preset val. selection bit 1	Selection bit with the valency 2 ¹ for the bit-coded selection and activation of a parameterisable setpoint (preset value).
0x400E:011 (PAR 505/011)	NETWordIN1 function assignment: Bit 10 (NETWordIN1 config.: NETWordIN1.10) <ul style="list-style-type: none"> Setting can only be changed if controller inhibit is active. For possible settings see description for 0x400E:001 (PAR 505/001). □98 	Definition of the function that is to be triggered via bit 10 of the mappable NETWordIN1 data word.
	00 Not active	Trigger bit without any function.
0x400E:012 (PAR 505/012)	NETWordIN1 function assignment: Bit 11 (NETWordIN1 config.: NETWordIN1.11) <ul style="list-style-type: none"> Setting can only be changed if controller inhibit is active. For possible settings see description for 0x400E:001 (PAR 505/001). □98 	Definition of the function that is to be triggered via bit 11 of the mappable NETWordIN1 data word.
	00 Not active	Trigger bit without any function.
0x400E:013 (PAR 505/013)	NETWordIN1 function assignment: Bit 12 (NETWordIN1 config.: NETWordIN1.12) <ul style="list-style-type: none"> Setting can only be changed if controller inhibit is active. For possible settings see description for 0x400E:001 (PAR 505/001). □98 	Definition of the function that is to be triggered via bit 12 of the mappable NETWordIN1 data word.
	00 Not active	Trigger bit without any function.
0x400E:014 (PAR 505/014)	NETWordIN1 function assignment: Bit 13 (NETWordIN1 config.: NETWordIN1.13) <ul style="list-style-type: none"> Setting can only be changed if controller inhibit is active. For possible settings see description for 0x400E:001 (PAR 505/001). □98 	Definition of the function that is to be triggered via bit 13 of the mappable NETWordIN1 data word.
	00 Not active	Trigger bit without any function.
0x400E:015 (PAR 505/015)	NETWordIN1 function assignment: Bit 14 (NETWordIN1 config.: NETWordIN1.14) <ul style="list-style-type: none"> Setting can only be changed if controller inhibit is active. For possible settings see description for 0x400E:001 (PAR 505/001). □98 	Definition of the function that is to be triggered via bit 14 of the mappable NETWordIN1 data word.
	00 Not active	Trigger bit without any function.



Configuring the network

General network settings

Parameter	Name / value range / [default setting]	Info
0x400E:016 (PAR 505/016)	NETWordIN1 function assignment: Bit 15 (NETWordIN1 config.: NETWordIN1.15) <ul style="list-style-type: none"> Setting can only be changed if controller inhibit is active. For possible settings see description for 0x400E:001 (PAR 505/001). □ 98 	Definition of the function that is to be triggered via bit 15 of the mappable NETWordIN1 data word.
	00 Not active	Trigger bit without any function.
0x2022:027 (PAR 700/027)	Device commands: Accept new inverter hardware (Device commands: Accept new HW) 0 ... [0] ... 1 <ul style="list-style-type: none"> Setting can only be changed if controller inhibit is active. 	1 = initialise parameters for a new network option.
0x2631:037 (PAR 400/037)	Function assignment: Network enable (Function list: Network enable) <ul style="list-style-type: none"> For possible settings see description for 0x2631:001 (PAR 400/001). □ 188 	Assignment of a trigger for the "Network enable" function. Trigger = TRUE: activate network control mode. Trigger = FALSE: no action / deactivate network control mode again.
	00 Not connected	No trigger assigned (trigger is constantly FALSE).
0x2860:001 (PAR 201/001)	Standard setpoint sources: Frequency setpoint source (Standard setpoint: Frequency setp.) <ul style="list-style-type: none"> For possible settings see description for 0x2860:001 (PAR 201/001). □ 70 	Selection of the standard setpoint source for speed mode. <ul style="list-style-type: none"> The standard setpoint source is always active in speed mode if no setpoint change-over to another setpoint source via corresponding triggers/functions is active. ▶ Setpoint change-over □ 193
	2 Analog input 1	The setpoint is specified analogously via X3/AI1. ▶ Analog input 1 □ 211
0x2860:002 (PAR 201/002)	Standard setpoint sources: Process controller setpoint source (Standard setpoint: PID setpoint) <ul style="list-style-type: none"> For possible settings see description for 0x2860:002 (PAR 201/002). □ 70 	Selection of the standard setpoint source for process controller mode. <ul style="list-style-type: none"> The standard setpoint source is always active in process controller mode if no setpoint change-over to another setpoint source via corresponding triggers/functions is active.
	1 Keypad	The setpoint is specified locally by the keypad. <ul style="list-style-type: none"> Default setting: 0x2601:002 (PAR 202/002) Use the ↑ and ↓ navigation keys to change the keypad setpoint (also during running operation).
0x2860:003 (PAR 201/003)	Standard setpoint sources: Torque setpoint source (Standard setpoint: Torque setp.)	Selection of the standard setpoint source for torque mode. <ul style="list-style-type: none"> The standard setpoint source is always active in torque mode if no setpoint change-over to another setpoint source via corresponding triggers/functions is active.
	1 Keypad	The setpoint is specified locally by the keypad. <ul style="list-style-type: none"> Use the ↑ and ↓ navigation keys to change the keypad setpoint (also during running operation).
	2 Analog input 1	The setpoint is specified analogously via X3/AI1. ▶ Analog input 1 □ 211
	3 Analog input 2	The setpoint is specified analogously via X3/AI2. ▶ Analog input 2 □ 213
	50 Motor potentiometer	The setpoint is generated by the "Motor potentiometer" function. ▶ Motor potentiometer setpoint source □ 198



8.2 Predefined process data words

Process data are exchanged via cyclic data exchange between the network master and the inverter.

Details

For the cyclic data exchange, the inverter is provided with 24 network registers.

- 12 network registers are provided as input registers for data words from the network master to the inverter.
- 12 network registers are provided as output registers for data words from the inverter to the network master.
- Each network register is provided with a corresponding code that defines which parameters (or other data codes) are mapped to the network register.
- The input and output registers are divided into three blocks (A, B, C) in each case, featuring 4 successive data words, respectively:

Network register	
Input register	Output register
Network IN A0	Network OUT A0
Network IN A1	Network OUT A1
Network IN A2	Network OUT A2
Network IN A3	Network OUT A3
Network IN B0	Network OUT B0
Network IN B1	Network OUT B1
Network IN B2	Network OUT B2
Network IN B3	Network OUT B3
Network IN C0	Network OUT C0
Network IN C1	Network OUT C1
Network IN C2	Network OUT C2
Network IN C3	Network OUT C3

The terms "input" and "output" refer to the point of view of the inverter:

- Input data are transmitted by the network master and received by the inverter.
- Output data are transmitted by the inverter and received by the network master.



The exact assignment of the network registers and the number of data words that can be transmitted cyclically varies according to the network/communication protocol. You can find some detailed information in the documentation for the respective communication protocol.

Data mapping

For establishing a simple network connection, the inverter provides predefined control and status words for device profile CiA402, AC drive profile as well as in LECOM format. By means of data mapping to a network register, each of these words can be transferred as process data via network. Additionally, further mappable data words to individually control the inverter are provided. The mappable data words are described in detail in the following subchapters.



Data mapping cannot be applied to all parameters. The mappable parameters are marked correspondingly in the parameter attribute list. ▶ [Parameter attribute list](#)  229



8.2.1 Device profile CiA402

For control via CiA402 device profile, the parameters listed in the following can be mapped to network registers.

Details

- The Controlword features the mapping address 0x60400000.
- The Statusword features the mapping address 0x60410000.
- General information about the process of data mapping can be found in the chapter of the same name for the corresponding network.
- For further CiA402 parameters, see the "Device profile CiA402" chapter. [177](#)

Parameter	Name / value range / [default setting]	Info	
0x6040	Controlword 0 ... [0] ... 65535	Mappable CiA402 control word with bit assignment in compliance with CiA402 device profile.	
	Bit 0	Switch on	
	Bit 1	Enable voltage	
	Bit 2	Quick stop	
	Bit 3	Enable operation	
	Bit 4	Operation mode specific	
	Bit 5		
	Bit 6		
	Bit 7	Fault reset	
	Bit 8	n/a	Bit is not supported.
	Bit 9	Operation mode specific	
	Bit 10	Reserved	
	Bit 11	Override coast	
	Bit 12	Autolnit	
	Bit 13	Reserved	
	Bit 14	Release holding brake	
Bit 15	Reserved		
0x6041 (PAR 780)	Statusword (Statusword) • Read only	Mappable CiA402 status word with bit assignment in compliance with CiA402 device profile.	
	Bit 0	Ready to switch on	
	Bit 1	Switched on	
	Bit 2	Operation enabled	
	Bit 3	Fault active	
	Bit 4	Voltage enabled	
	Bit 5	Quick stop	
	Bit 6	Switch on disabled	
	Bit 7	Warning active	
	Bit 8	Deactivate RPDOs	1 ≡ cyclic PDOs have been deactivated.
	Bit 9	Remote	1 ≡ inverter can receive commands via network.
	Bit 10	Target reached	1 ≡ the actual position is in the window.
	Bit 11	Internal limit active	1 ≡ internal limitation of a setpoint active.
	Bit 12	Operation mode active	
	Bit 13	Following error	
	Bit 14	Holding brake released	
Bit 15	Safe torque off (STO) not active		

Configuring the network

Predefined process data words
AC Drive Profile



8.2.2 AC Drive Profile

For control via AC drive profile, the parameters listed in the following can be mapped to network registers.

Details

- The AC Drive control word features the mapping address 0x400B0100.
- The AC Drive status word features the mapping address 0x400C0100.
- General information about the process of data mapping can be found in the chapter of the same name for the corresponding network.

Parameter	Name / value range / [default setting]	Info	
0x400B:001 (PAR 592/001)	Predefined process input data: AC Drive control word (Legacy NetWordIN: AC control word) 0x0000 ... [0x0000] ... 0xFFFF	Mappable control word with bit assignment in compliance with EtherNet/IP™ AC drive profile.	
	Bit 0	Run forward	
	Bit 1	Run reverse	
	Bit 2	Reset error (0-1 edge)	
	Bit 3	Reserved	
	Bit 4		
	Bit 5	Control from Network	
	Bit 6	Reference from Network	
	Bit 7	Reserved	
	Bit 8		
	Bit 9		
	Bit 10		
	Bit 11		
	Bit 12	Controller inhibit	
	Bit 13	Quick stop	
Bit 14	Process controller off		
Bit 15	DC braking		
0x400C:001 (PAR 593/001)	Predefined process output data: AC Drive status word (Old netw. off: AC drive status word) • Read only	Mappable status word with bit assignment in compliance with EtherNet/IP™ AC drive profile.	
	Bit 0	Fault/Trip	
	Bit 1	Reserved	
	Bit 2	Running Forward	
	Bit 3	Running Reverse	
	Bit 4	Ready	
	Bit 5	Control from Network	
	Bit 6	Reference from Network	
	Bit 7	At Reference	
	Bit 8	Reserved	
	Bit 9		
	Bit 10		
	Bit 11		
	Bit 12	Process controller active	
	Bit 13	Torque mode active	
Bit 14	Current limit reached		
Bit 15	DC braking active		



8.2.3 Lenze LECOM profile

For connection to Lenze inverters with a LECOM control word (C135) and LECOM status word (C150), the parameters listed in the following can be mapped to network registers.

Details

- The LECOM control word (C135) features the mapping address 0x400B0200.
- The LECOM status word (C150) features the mapping address 0x400C0200.
- General information about the process of data mapping can be found in the chapter of the same name for the corresponding network.

Parameter	Name / value range / [default setting]	Info
0x400B:002 (PAR 592/002)	Predefined process input data: LECOM control word (C135) (Legacy NetWordIN: C0135 control word) 0x0000 ... [0x0000] ... 0xFFFF	Mappable control word with bit assignment in compliance with code C135 of the 8200 Lenze inverter.
	Bit 0	Setpoint Selection bit 0
	Bit 1	Setpoint Selection bit 1
	Bit 2	Reversal
	Bit 3	Quick stop
	Bit 4	Reserved
	Bit 5	
	Bit 6	
	Bit 7	
	Bit 8	
	Bit 9	Controller inhibit
	Bit 10	User-defined fault
	Bit 11	Reset error (0-1 edge)
	Bit 12	Reserved
	Bit 13	
	Bit 14	DC braking
Bit 15	Reserved	
0x400C:002 (PAR 593/002)	Predefined process output data: LECOM status word (C150) (Old netw. off: C0150 status word) • Read only	Mappable status word with bit assignment in compliance with code C150 of the 8200 Lenze inverter.
	Bit 0	Active parameter set (0 = set 1 or 3; 1 = set 2 or 4)
	Bit 1	Power section inhibited
	Bit 2	Current or Torque limit reached
	Bit 3	Frequency setpoint reached
	Bit 4	Ramp generator (input = output)
	Bit 5	Frequency < frequency threshold
	Bit 6	Actual frequency = 0
	Bit 7	Controller inhibit
	Bit 8	Coded status bit 0
	Bit 9	Coded status bit 1
	Bit 10	Coded status bit 2
	Bit 11	Coded status bit 3
	Bit 12	Overtemperature warning
	Bit 13	DC-bus overvoltage
	Bit 14	Reversal
Bit 15	Ready for Operation	

Configuring the network

Predefined process data words
Further process data



8.2.4 Further process data

The parameters listed in the following can also be mapped to network registers, in order to transmit control and status information as well as setpoints and actual values as process data.

Details

- The following parameters are always available irrespective of the network option.
- The use of these parameters for the transmission of process data is optional. It is also possible to only use part of the parameters. For the transmission of the frequency setpoint and actual value, for instance several parameters with a different resolution can be selected.
- Via the parameters, at the same time the general network activity can be diagnosed.

NetWordIN1 ... NetWordIN4

These four mappable data words are provided to individually control the inverter:

- NetWordIN1: for the implementation of an individual control word format. [▶ General network settings](#) [□ 97](#)
- NetWordIN2: for control of the digital outputs via network. [▶ Configuration of digital outputs](#) [□ 215](#)
- NetWordIN3 and NetWordIN4: for control of the analog outputs via network. [▶ Configuration of analog outputs](#) [□ 221](#)

NetWordOUT1 and NetWordOUT2

These two mappable data words are provided to output status messages to the network master:

- NetWordOUT1: for the implementation of an individual status word format. [▶ NETWordOUT1 status word](#) [□ 218](#)
- NetWordOUT2: for the output of messages of the "Sequencer" function (in preparation).

Parameter	Name / value range / [default setting]	Info	
0x4008:001 (PAR 590/001)	Process input words: NETWordIN1 (NETWordIN stat: NETWordIN1) 0x0000 ... [0x0000] ... 0xFFFF	Mappable data word for flexible control of the inverter via network. Assignment of the functions: <ul style="list-style-type: none"> • 0x400E:001 (PAR 505/001): assignment of functions to bit 0 ... 15. 	
	Bit 0		Mapping bit 0
	Bit 1		Mapping bit 1
	Bit 2		Mapping bit 2
	Bit 3		Mapping bit 3
	Bit 4		Mapping bit 4
	Bit 5		Mapping bit 5
	Bit 6		Mapping bit 6
	Bit 7		Mapping bit 7
	Bit 8		Mapping bit 8
	Bit 9		Mapping bit 9
	Bit 10		Mapping bit 10
	Bit 11		Mapping bit 11
	Bit 12		Mapping bit 12
	Bit 13		Mapping bit 13
	Bit 14		Mapping bit 14
Bit 15	Mapping bit 15		
0x4008:002 (PAR 590/002)	Process input words: NETWordIN2 (NETWordIN stat: NETWordIN2) 0x0000 ... [0x0000] ... 0xFFFF	Mappable data word for optional control of the digital outputs via network. Assignment of the digital outputs: <ul style="list-style-type: none"> • 0x2634:001 (PAR 420/001) = 34 ... 49: assignment of the relay output to bit 0 ... 15. • 0x2634:002 (PAR 420/002) = 34 ... 49: assignment of digital output 1 to bit 0 ... 15. • = 34 ... 49: assignment of digital output 2 to bit 0 ... 15. 	
	Bit 0		Mapping bit 0
	Bit 1		Mapping bit 1
	Bit 2		Mapping bit 2
	Bit 3		Mapping bit 3
	Bit 4		Mapping bit 4
	Bit 5		Mapping bit 5
	Bit 6		Mapping bit 6
Bit 7	Mapping bit 7		



Configuring the network

Predefined process data words
Further process data

Parameter	Name / value range / [default setting]	Info
	Bit 8 Mapping bit 8	
	Bit 9 Mapping bit 9	
	Bit 10 Mapping bit 10	
	Bit 11 Mapping bit 11	
	Bit 12 Mapping bit 12	
	Bit 13 Mapping bit 13	
	Bit 14 Mapping bit 14	
	Bit 15 Mapping bit 15	
0x4008:003 (PAR 590/003)	Process input words: NETWordIN3 (NETWordIN stat: NETWordIN3) 0.0 ... [0.0] ... 100.0 %	Mappable data word for optional control of an analog output via network. Assignment of the analog outputs: <ul style="list-style-type: none"> • 0x2639:002 (PAR 440/002) = 20: analog output 1 or • = 20: analog output 2
0x4008:004 (PAR 590/004)	Process input words: NETWordIN4 (NETWordIN stat: NETWordIN4) 0.0 ... [0.0] ... 100.0 %	Mappable data word for optional control of an analog output via network. Assignment of the analog outputs: <ul style="list-style-type: none"> • 0x2639:002 (PAR 440/002) = 21: analog output 1 or • = 21: analog output 2
0x400A:001 (PAR 591/001)	Process output words: NetWordOUT1 (NetzWortOUT Stat: NetzWortOUT1) • Read only	Mappable data word for the output of status messages of the inverter via network. Assignment of the status messages: <ul style="list-style-type: none"> • 0x2634:010 (PAR 420/010): assignment of status message to bit 0. • 0x2634:011 (PAR 420/011): assignment of status message to bit 1. • ... • 0x2634:025 (PAR 420/025): assignment of status message to bit 15.
	Bit 0 Mapping bit 0	
	Bit 1 Mapping bit 1	
	Bit 2 Mapping bit 2	
	Bit 3 Mapping bit 3	
	Bit 4 Mapping bit 4	
	Bit 5 Mapping bit 5	
	Bit 6 Mapping bit 6	
	Bit 7 Mapping bit 7	
	Bit 8 Mapping bit 8	
	Bit 9 Mapping bit 9	
	Bit 10 Mapping bit 10	
	Bit 11 Mapping bit 11	
	Bit 12 Mapping bit 12	
	Bit 13 Mapping bit 13	
	Bit 14 Mapping bit 14	
	Bit 15 Mapping bit 15	
0x400A:002 (PAR 591/002)	Process output words: NetWordOUT2 (NetzWortOUT Stat: NetzWortOUT2) • Read only	Mappable data word for the output of messages of the "Sequencer" function via network.
	Bit 0 Mapping bit 0	
	Bit 1 Mapping bit 1	
	Bit 2 Mapping bit 2	
	Bit 3 Mapping bit 3	
	Bit 4 Mapping bit 4	
	Bit 5 Mapping bit 5	
	Bit 6 Mapping bit 6	
	Bit 7 Mapping bit 7	
	Bit 8 Mapping bit 8	
	Bit 9 Mapping bit 9	
	Bit 10 Mapping bit 10	
	Bit 11 Mapping bit 11	
	Bit 12 Mapping bit 12	
	Bit 13 Mapping bit 13	
	Bit 14 Mapping bit 14	
	Bit 15 Mapping bit 15	

Configuring the network

Predefined process data words
Further process data



Parameter	Name / value range / [default setting]	Info
0x400B:003 (PAR 592/003)	Predefined process input data: Network setpoint frequency [0.1 Hz] (Legacy NetWordIN: Netwfreq. 0.1Hz) 0.0 ... [0.0] ... 599.0 Hz	Mappable parameter for specifying the frequency setpoint in [0.1 Hz] via network. <ul style="list-style-type: none"> The specification is made without sign (irrespective of the rotating direction). The rotating direction is specified via the control word. Example: 456 ≙ 45.6 Hz
0x400B:004 (PAR 592/004)	Predefined process input data: Network setpoint speed [r/min] (Legacy NetWordIN: Netwspeed r/min) 0 ... [0] ... 50000 rpm	Mappable parameter for specifying the setpoint as speed in [rpm] via network. <ul style="list-style-type: none"> The specification is made without sign (irrespective of the rotating direction). The rotating direction is specified via the control word. Example: 456 ≙ 456 rpm
0x400B:005 (PAR 592/005)	Predefined process input data: Network setpoint frequency [0.01 Hz] (Legacy NetWordIN: Netwfreq. 0.01Hz) 0.00 ... [0.00] ... 599.00 Hz	Mappable parameter for specifying the frequency setpoint in [0.01 Hz] via network. <ul style="list-style-type: none"> The specification is made without sign (irrespective of the rotating direction). The rotating direction is specified via the control word. Example: 456 ≙ 4.56 Hz
0x400C:003 (PAR 593/003)	Predefined process output data: Actual frequency [0.1 Hz] (Old netw. off: Actual frequency Hz) • Read only: x.x Hz	Mappable parameter for the output of the actual frequency value in [0.1 Hz] via network. <ul style="list-style-type: none"> The output is effected without sign (irrespective of the rotating direction). The rotating direction is specified via the status word. Example: 456 ≙ 45.6 Hz
0x400C:004 (PAR 593/004)	Predefined process output data: Actual motor speed [r/min] (Old netw. off: Act. speed r/min) • Read only: x rpm	Mappable parameter for the output of the actual value as speed in [rpm] via network. <ul style="list-style-type: none"> The output is effected without sign (irrespective of the rotating direction). The rotating direction is specified via the status word. Example: 456 ≙ 456 rpm
0x400C:005 (PAR 593/005)	Predefined process output data: Drive status (Old netw. off: Drive status) • Read only	Mappable status word (Modbus Legacy Register 2003).
	0 Error (non-resettable)	
	1 Error	
	2 Waiting for start	
	3 Identification not executed	
	4 Controller inhibit	
	5 Stop	
	7 Identification	
	8 Running	
	9 Acceleration	
	10 Deceleration	
	11 Deceleration override	
	12 DC braking	
	13 Flying Start	
	14 Current limit reached	
	16 Process controller idle state	
0x400C:006 (PAR 593/006)	Predefined process output data: Actual frequency [0.01 Hz] (Old netw. off: Act. freq. 0.01Hz) • Read only: x.xx Hz	Mappable parameter for the output of the actual frequency value in [0.01 Hz] via network. <ul style="list-style-type: none"> The output is effected without sign (irrespective of the rotating direction). The rotating direction is specified via the status word. Example: 456 ≙ 4.56 Hz



8.3 Acyclic data exchange

The acyclic data exchange is normally used for transmitting parameter data the transmission of which is not time-critical. Such parameter data are for example operating parameters, motor data, and diagnostic information.

Details

- The acyclic data exchange enables access to all parameters of the inverter.
- For all communication protocols except Modbus, the parameter is addressed directly via the index and subindex.
- The parameter attribute list contains a list of all inverter parameters. This list in particular includes some information that is relevant to the reading and writing of parameters via the network. ▶ [Parameter attribute list](#)  229

Configuring the network

CANopen
CANopen introduction



8.4 CANopen

CANopen is an internationally approved communication protocol which is designed for commercial and industrial automation applications. High data transfer rates in connection with efficient data formatting provide for the coordination of motion control devices in multi-axis applications.



Information about the dimensioning of a CANopen network can be found in the configuration document for the inverter.

Preconditions

- Control unit (CU) of the inverter is provided with Modbus/CANopen.
- Modbus/CANopen selector at the inverter front is set to "CANopen".

8.4.1 CANopen introduction

- The Lenze implementation of the CANopen communication profile (CiA DS301, version 4.02) enables baud rates from 20 kbps to 1 Mbps.
- For establishing a simple network connection, the inverter provides predefined control and status words for device profile CiA402, AC drive profile and in LECOM format. Additionally, further mappable data words are provided to individually control the inverter.
- The inverter control is preconfigured via a CiA402-compliant control word.

8.4.2 CANopen node address

Each network node must be provided with a unique node address.

Details

- The node address can be set in [0x2301:001 \(PAR 510/001\)](#).
- The setting that is active when the inverter is switched on is the effective setting.
- The active node address is shown in [0x2302:001 \(PAR 511/001\)](#).

Parameter	Name / value range / [default setting]	Info
0x2301:001 (PAR 510/001)	CANopen settings: Node ID (CANopen sett.: Node ID) 1 ... [1] ... 127	Setting of the node address. <ul style="list-style-type: none">• A change in the node address will not be effective until a CAN Reset Node is performed.
0x2302:001 (PAR 511/001)	Active CANopen settings: Node ID (CANopen status: Node ID) <ul style="list-style-type: none">• Read only	Display of the active node address.
0x2303 (PAR 509)	DIP switch position (DIP switch) <ul style="list-style-type: none">• Read only	Display of the DIP switch setting at the last mains power-on.



8.4.3 CANopen baud rate

All network nodes must be set to the same baud rate.

Details

- The baud rate can be set in [0x2301:002 \(PAR 510/002\)](#).
- The setting that is active when the inverter is switched on is the effective setting.
- The active baud rate is shown in [0x2302:002 \(PAR 511/002\)](#).

Parameter	Name / value range / [default setting]	Info
0x2301:002 (PAR 510/002)	CANopen settings: Baud rate (CANopen sett.: Baud rate)	Setting of the baud rate. • A change in the baud rate will not be effective until a CAN reset node is performed.
	1 20 kbps	
	2 50 kbps	
	3 125 kbps	
	4 250 kbps	
	5 500 kbps	
	6 800 kbps	
	7 1 Mbps	
0x2302:002 (PAR 511/002)	Active CANopen settings: Baud rate (CANopen status: Baud rate) • Read only	Display of the active baud rate.
	0 Automatic	
	1 20 kbps	
	2 50 kbps	
	3 125 kbps	
	4 250 kbps	
	5 500 kbps	
	6 800 kbps	
7 1 Mbps		

8.4.4 CANopen initialisation

If the initialisation of the CANopen network and the associated status change from "Pre-Operational" to "Operational" is not effected by a higher-level host system, the inverter can instead be defined as a "quasi" master to execute this task.

Details

Configuration of the inverter as CAN master is carried out in [0x2301:003 \(PAR 510/003\)](#). As CAN master, the controller sets all nodes connected to the bus (broadcast telegram) to the "Operational" communication state using the "Start remote node" NMT telegram. Only this communication state enables data exchange via the process data objects.



A change in master/slave operation only becomes effective by repeated mains switching of the inverter or by transmitting the "Reset Node" or "Reset Communication" NMT telegram to the inverter. As an alternative to the "Reset Node" NMT telegram, the "Reset network node" [0x2022:016 \(PAR 700/016\)](#) device command is provided for reinitialisation of the CAN-specific device parameters.

Parameter	Name / value range / [default setting]	Info
0x2301:003 (PAR 510/003)	CANopen settings: Slave/Master (CANopen sett.: Slave/Master)	1 = after mains switching, inverter starts as CAN master.
	0 Slave	
	1 Mini-master	
0x2301:004 (PAR 510/004)	CANopen settings: Start of remote deceleration (CANopen sett.: Start rem. dec.) 0 ... [3000] ... 65535 ms	If the inverter has been defined as CAN master, a delay time can be set here, which has to elapse after mains switching before the inverter deposits the "Start Remote Node" NMT telegram on the CAN bus.

Configuring the network

CANopen
CANopen diagnostics



8.4.5 CANopen diagnostics

For the purpose of diagnostics, the inverter provides several status words via which the CAN bus status, the CAN bus controller status, and the status of different time monitoring functions can be queried.

Parameter	Name / value range / [default setting]	Info
0x2307 (PAR 515)	CANopen time-out status (Time-out status) • Read only	Bit-coded status display of the CAN time monitoring functions.
Bit 0	RPDO1-Timeout	1 ≡ RPDO1 was not received within the monitoring time or not with the sync configured. • Status is reset automatically after the RPDO has been received again. • Setting of monitoring time for RPDO1 in 0x1400:005 (PAR 540/005) .
Bit 1	RPDO2-Timeout	1 ≡ RPDO2 was not received within the monitoring time or not with the sync configured. • Status is reset automatically after the RPDO has been received again. • Setting of monitoring time for RPDO2 in 0x1401:005 (PAR 541/005) .
Bit 2	RPDO3-Timeout	1 ≡ RPDO3 was not received within the monitoring time or not with the sync configured. • Status is reset automatically after the RPDO has been received again. • Setting of monitoring time for RPDO3 in 0x1402:005 (PAR 542/005) .
Bit 3	Reserved	-
Bit 4		
Bit 5		
Bit 6		
Bit 7		
Bit 8	Heartbeat-Timeout Consumer 1	1 ≡ within the "Heartbeat Consumer Time", no heartbeat telegram was received from node 1 to be monitored. • Status can only be reset by mains switching. • "Heartbeat Consumer Time" setting in 0x1016:001 (PAR 520/001) .
Bit 9	Heartbeat-Timeout Consumer 2	1 ≡ within the "Heartbeat Consumer Time", no heartbeat telegram was received from node 2 to be monitored. • Status can only be reset by mains switching. • "Heartbeat Consumer Time" setting in 0x1016:002 (PAR 520/002) .
Bit 10	Heartbeat-Timeout Consumer 3	1 ≡ within the "Heartbeat Consumer Time", no heartbeat telegram was received from node 3 to be monitored. • Status can only be reset by mains switching. • "Heartbeat Consumer Time" setting in 0x1016:003 (PAR 520/003) .
Bit 11	Heartbeat-Timeout Consumer 4	1 ≡ within the "Heartbeat Consumer Time", no heartbeat telegram was received from node 4 to be monitored. • Status can only be reset by mains switching. • "Heartbeat Consumer Time" setting in 0x1016:004 (PAR 520/004) .
Bit 12	Reserved	-
Bit 13		
Bit 14		
Bit 15		
Bit 16		
Bit 17		
Bit 18		
Bit 19		
Bit 20		
Bit 21		
Bit 22		
Bit 23		
Bit 24		
Bit 25		
Bit 26		
Bit 27		
Bit 28		
Bit 29		
Bit 30		



Parameter	Name / value range / [default setting]	Info
	Bit 31	
0x2308 (PAR 516)	CANopen status (CANopen status) • Read only	Display of the current CAN bus state.
	0 Initialisation	CAN bus initialisation active. • The initialisation is started automatically at mains connection. During this phase, the inverter is not involved in the data exchange process on the CAN bus. • The standard values are re-written to all CAN-relevant parameters. • When the initialisation process has been completed, the inverter automatically adopts the "Pre-Operational" state.
	1 Reset node	"Reset Node" NMT command active. • Initialisation of all CAN-relevant parameters with the values stored.
	2 Reset communication	"Reset Communication" NMT command active. • Initialisation of all CAN-relevant parameters with the values stored.
	4 Stopped	Only network management telegrams can be received.
	5 Operational	Parameter data and process data can be received.
	127 Pre-Operational	Parameter data can be received, process data are ignored.
0x2309 (PAR 517)	CANopen controller status (Controller status) • Read only	Status display of the internal CANopen controller.
	1 Error active	The inverter is a fully-fledged communication node at the CANopen network. It is able to transmit and receive data and to report faults.
	2 Error passive	The inverter can only passively indicate faulty reception via the ACK field.
	3 Bus off	The inverter is electrically separated from the CANopen network. In order to exit this state, the CANopen interface must be reset.

8.4.6 CANopen emergency telegram

If the error status changes when an internal device error occurs or is remedied, an emergency telegram is sent to the NMT master once.

Details

- The identifier for the emergency telegram is fixedly defined and is shown in [0x1014](#).
- In [0x1015](#), a blocking time can be set, in order to limit the bus load in the case of emergency telegrams following quickly in succession.

Parameter	Name / value range / [default setting]	Info
0x1014	COB-ID EMCY • Read only	Display of the identifier for emergency telegrams.
0x1015	Inhibit time EMCY 0.0 ... [0.0] ... 6553.5 ms	Blocking time which can be set in order to limit the bus load in the case of emergency telegrams following quickly in succession.

8.4.7 CANopen heartbeat protocol

The heartbeat protocol can be used for node monitoring purposes within a CAN network.

Details

Basic procedure:

1. A heartbeat producer cyclically sends a heartbeat telegram to one or several receivers (consumers).
2. The consumer(s) monitor(s) the heartbeat telegram for arrival on a regular basis.

The inverter can be configured as producer or as consumer to monitor up to four other nodes.

Parameter	Name / value range / [default setting]	Info
0x1016:000 (PAR 520/000)	Consumer heartbeat time: Highest subindex (Cons heartbeat: Highest subindex) • Read only	Number of nodes to be monitored.
0x1016:001 (PAR 520/001)	Consumer heartbeat time: Node 1 (Cons heartbeat: Node 1) 0x00000000 ... [0x00000000] ... 0x00FFFFFF	Node ID and heartbeat time of node 1 which is to be monitored. • Format: 0x00nnhhhh (nn = node ID, hhhh = heartbeat time in [ms])

Configuring the network

CANopen

CANopen heartbeat protocol



Parameter	Name / value range / [default setting]	Info
0x1016:002 (PAR 520/002)	Consumer heartbeat time: Node 2 (Cons heartbeat: Node 2) 0x00000000 ... [0x00000000] ... 0x00FFFFFF	Node ID and heartbeat time of node 2 which is to be monitored. <ul style="list-style-type: none">• Format: 0x00nnhhhh (nn = node ID, hhhh = heartbeat time in [ms])
0x1016:003 (PAR 520/003)	Consumer heartbeat time: Node 3 (Cons heartbeat: Node 3) 0x00000000 ... [0x00000000] ... 0x00FFFFFF	Node ID and heartbeat time of node 3 which is to be monitored. <ul style="list-style-type: none">• Format: 0x00nnhhhh (nn = node ID, hhhh = heartbeat time in [ms])
0x1016:004 (PAR 520/004)	Consumer heartbeat time: Node 4 (Cons heartbeat: Node 4) 0x00000000 ... [0x00000000] ... 0x00FFFFFF	Node ID and heartbeat time of node 4 which is to be monitored. <ul style="list-style-type: none">• Format: 0x00nnhhhh (nn = node ID, hhhh = heartbeat time in [ms])
0x1017 (PAR 522)	Producer heartbeat time (Prod heartbeat) 0 ... [0] ... 65535 ms	Time interval for the transmission of the heartbeat telegram to the consumer(s). <ul style="list-style-type: none">• The heartbeat telegram is sent automatically as soon as a time > 0 ms is set.• The time set is rounded down to an integer multiple of 5 ms.



8.4.8 CANopen process data objects

Process data objects (PDOs) are used for the cyclic transmission of (process) data via CANopen. PDOs only contain data and an identifier. They do not contain any information about the sender or receiver and are therefore very efficient.

Details

- Process data objects which the inverter receives via the network are referred to as "Receive PDOs" (RPDOs).
- Process data objects which the inverter sends via the network are referred to as "Transmit PDOs" (TPDOs).
- The maximum length of a PDO is 8 bytes (4 data words).
- Each PDO requires a unique identifier ("COB-ID") for the purpose of identification within the network.
- Furthermore the transmission type must be defined for TPDOs (see the following section).
- Communication parameters such as the transmission type and cycle time for each PDO can be set freely and independently of the settings of other PDOs

Transmission type

Process data objects can be transmitted in an event-controlled or time-controlled manner. The below table shows that it is possible to combine the different methods by means of logic operations (AND, OR):

- Event-controlled: The PDO is sent if a special device-internal event has occurred, for instance, if the data contents of the TPDO have changed or if a transmission cycle time has elapsed.
- Synchronous transmission: Transmission of a TPDOs or reception of an RPDO is effected after the inverter has received a sync telegram (COB-ID 0x80).
- Cyclic transmission: The cyclic transmission of PDOs is effected when the transmission cycle time has elapsed.
- Polled via RTR: Transmission of a TPDO is carried out on request by another device via data request frame (RTR remote transmit request). For this, the data requester (e.g. master) sends the data request frame with the COB-ID of the TPDO that is to be requested to transmit. The receiver recognises the RTR and carries out the transmission.

Transmission type	PDO transmission			Logic combination of different transmission types
	cyclic	synchronous	event-controlled	
0		●	●	AND
1 ... 240		●		-
254, 255	●		●	OR

Transmission type	Description
0	Synchronous and acyclic <ul style="list-style-type: none"> • The PDO is transmitted on an event-controlled basis with every sync (e.g. when a bit change occurs in the PDO).
1 ... 240	Synchronous and cyclic (sync-controlled with a response) <ul style="list-style-type: none"> • Selection n = 1: The PDO is transmitted with every sync. • Selection 1 < n ≤ 240: The PDO is transmitted with every n-th sync.
241 ... 251	Reserved
252	Synchronous - RTR only
253	Asynchronous - RTR only
254, 255	Asynchronous - manufacturer-specific / device profile-specific <ul style="list-style-type: none"> • If one of these values is entered, the PDO is transferred in an event-controlled or cyclic manner. (The values "254" and "255" are equivalent). • For a cyclic transmission, a cycle time must be entered for the respective PDO. In this case, cyclic transmission takes place in addition to event-controlled transmission.

Configuring the network

CANopen
CANopen process data objects



Synchronisation of PDOs via sync telegram

During cyclic transmission, one or more PDOs are transmitted/received in fixed time intervals. An additional specific telegram, the so-called sync telegram, is used for synchronising cyclic process data.

- The sync telegram is the trigger point for the transmission of process data from the slaves to the master and for the acceptance of process data from the master in the slaves.
- For sync-controlled process data processing, the sync telegram must be generated accordingly.
- The response to a sync telegram is determined by the transmission type selected.

Generating the sync telegram:

- **0x1005** can be used to activate the generation of sync telegrams and to write the identifier value.
- Sync telegrams are created when bit 30 (see below) is set to "1".
- The interval between sync telegrams is to be set in **0x1006**.

Writing identifiers:

- To receive PDOs, the value 0x80 must be entered in the 11-bit identifier in the Lenze setting (and in compliance with the CANopen specification). This means that all inverters are set to the same sync telegram by default.
- If sync telegrams are only to be received by specific nodes, their identifiers can be entered with a value of up to and including 0x07FF.
- The identifier can only be changed if the inverter does not send any sync telegrams (**0x1005**, Bit 30 = "0").

Data telegram assignment

8th byte (data 4)		7th byte (data 3)	6th byte (data 2)	5th byte (data 1)
Bit 31	Bit 30	Bit 29 ... bit 11		Bit 10 ... bit 0
x	0/1	Extended identifier*		11-bit identifier

* The extended identifier is not supported. Bit 11 ... bit 29 must be set to "0".

Parameter	Name / value range / [default setting]	Info
0x1005	COB-ID SYNC 0x00000000 ... [0x00000080] ... 0xFFFFFFFF	Identifier for sync telegram. How to change the identifier: 1. Deactivate Sync: Set bit 30 to "0". 2. Change identifier. 3. Activate Sync: Set bit 30 to "1".
0x1006	Communication cyclic period 0 ... [0] ... 65535000 us	Cycle time for sync telegrams. • A setting of "1000" or integer multiples of this settings are possible. • With the setting "0", no sync telegrams are generated.
0x1400:000	RPDO1 communication parameter: Highest subindex • Read only	
0x1400:001 (PAR 540/001)	RPDO1 communication parameter: COB-ID (RPDO1 config.: COB-ID) 0x00000000 ... [0x00000200] ... 0xFFFFFFFF	RPDO1: identifier How to change the identifier: 1. Set PDO to "invalid": Set bit 31 to "1". 2. Change identifier. 3. Reset PDO to "valid": Set bit 31 to "0".
0x1400:002 (PAR 540/002)	RPDO1 communication parameter: Transmission type (RPDO1 config.: Transm. type) 0 ... [255] ... 255	RPDO1: transmission type in compliance with DS301 V4.02
0x1400:005 (PAR 540/005)	RPDO1 communication parameter: Event timer (RPDO1 config.: Event timer) 0 ... [100] ... 65535 ms	RPDO1: time-out for the monitoring of data reception.
0x1401:001 (PAR 541/001)	RPDO2 communication parameter: COB-ID (RPDO2 config.: COB-ID) 0x00000000 ... [0x80000300] ... 0xFFFFFFFF	RPDO2: identifier How to change the identifier: 1. Set PDO to "invalid": Set bit 31 to "1". 2. Change identifier. 3. Reset PDO to "valid": Set bit 31 to "0".
0x1401:002 (PAR 541/002)	RPDO2 communication parameter: Transmission type (RPDO2 config.: Transm. type) 0 ... [255] ... 255	RPDO2: transmission type in compliance with DS301 V4.02



Configuring the network

CANopen
CANopen process data objects

Parameter	Name / value range / [default setting]	Info
0x1401:005 (PAR 541/005)	RPDO2 communication parameter: Event timer (RPDO2 config.: Event timer) 0 ... [100] ... 65535 ms	RPDO2: time-out for the monitoring of data reception.
0x1402:001 (PAR 542/001)	RPDO3 communication parameter: COB-ID (RPDO3 config.: COB-ID) 0x00000000 ... [0x80000400] ... 0xFFFFFFFF	RPDO3: identifier How to change the identifier: 1. Set PDO to "invalid": Set bit 31 to "1". 2. Change identifier. 3. Reset PDO to "valid": Set bit 31 to "0".
0x1402:002 (PAR 542/002)	RPDO3 communication parameter: Transmission type (RPDO3 config.: Transm. type) 0 ... [255] ... 255	RPDO3: transmission type in compliance with DS301 V4.02
0x1402:005 (PAR 542/005)	RPDO3 communication parameter: Event timer (RPDO3 config.: Event timer) 0 ... [100] ... 65535 ms	RPDO3: time-out for the monitoring of data reception.
0x1800:000	TPDO1 communication parameter: Highest subindex • Read only	The value "5" is permanently set.
0x1800:001 (PAR 550/001)	TPDO1 communication parameter: COB-ID (TPDO1 config.: COB-ID) 0x00000001 ... [0x40000180] ... 0xFFFFFFFF	TPDO1: identifier How to change the identifier: 1. Set PDO to "invalid": Set bit 31 to "1". 2. Change identifier. 3. Reset PDO to "valid": Set bit 31 to "0".
0x1800:002 (PAR 550/002)	TPDO1 communication parameter: Transmission type (TPDO1 config.: Transm. type) 0 ... [255] ... 255	TPDO1: transmission type in compliance with DS301 V4.02
0x1800:003 (PAR 550/003)	TPDO1 communication parameter: Inhibit time (TPDO1 config.: Inhibit time) 0.0 ... [0.0] ... 6553.5 ms	TPDO1: minimum time between the transmission of two identical PDOs (see DS301 V4.02).
0x1800:005 (PAR 550/005)	TPDO1 communication parameter: Event timer (TPDO1 config.: Event timer) 0 ... [20] ... 65535 ms	TPDO1: cycle time for PDO transmission with transmission type "254".
0x1801:000	TPDO2 communication parameter: Highest subindex • Read only	The value "5" is permanently set.
0x1801:001 (PAR 551/001)	TPDO2 communication parameter: COB-ID (TPDO2 config.: COB-ID) 0x00000001 ... [0xC0000280] ... 0xFFFFFFFF	TPDO2: identifier How to change the identifier: 1. Set PDO to "invalid": Set bit 31 to "1". 2. Change identifier. 3. Reset PDO to "valid": Set bit 31 to "0".
0x1801:002 (PAR 551/002)	TPDO2 communication parameter: Transmission type (TPDO2 config.: Transm. type) 0 ... [255] ... 255	TPDO2: transmission type in compliance with DS301 V4.02
0x1801:003 (PAR 551/003)	TPDO2 communication parameter: Inhibit time (TPDO2 config.: Inhibit time) 0.0 ... [0.0] ... 6553.5 ms	TPDO2: minimum time between the transmission of two identical PDOs (see DS301 V4.02).
0x1801:005 (PAR 551/005)	TPDO2 communication parameter: Event timer (TPDO2 config.: Event timer) 0 ... [0] ... 65535 ms	TPDO2: cycle time for PDO transmission with transmission type "254".
0x1802:000	TPDO3 communication parameter: Highest subindex • Read only	The value "5" is permanently set.
0x1802:001 (PAR 552/001)	TPDO3 communication parameter: COB-ID (TPDO3 config.: COB-ID) 0x00000001 ... [0xC0000380] ... 0xFFFFFFFF	TPDO3: identifier How to change the identifier: 1. Set PDO to "invalid": Set bit 31 to "1". 2. Change identifier. 3. Reset PDO to "valid": Set bit 31 to "0".
0x1802:002 (PAR 552/002)	TPDO3 communication parameter: Transmission type (TPDO3 config.: Transm. type) 0 ... [255] ... 255	TPDO3: transmission type in compliance with DS301 V4.02
0x1802:003 (PAR 552/003)	TPDO3 communication parameter: Inhibit time (TPDO3 config.: Inhibit time) 0.0 ... [0.0] ... 6553.5 ms	TPDO3: minimum time between the transmission of two identical PDOs (see DS301 V4.02).

Configuring the network

CANopen
CANopen data mapping



Parameter	Name / value range / [default setting]	Info
0x1802:005 (PAR 552/005)	TPDO3 communication parameter: Event timer (TPDO3 config.: Event timer) 0 ... [0] ... 65535 ms	TPDO3: cycle time for PDO transmission with transmission type "254".

8.4.9 CANopen data mapping

Data mapping serves to define which process data are transmitted cyclically via the process data channels.

Details

Data mapping (in the case of CANopen also referred to as "PDO mapping") is preconfigured for control of the inverter via the CiA402 device profile:

- RPDO1 = Controlword [0x6040](#) and Target velocity [0x6042 \(PAR 781\)](#).
- TPDO1 = Statusword [0x6041 \(PAR 780\)](#) and Velocity actual value [0x6044 \(PAR 783\)](#).

Variable PDO mapping

For individual drive solutions, the inverter supports "variable PDO mapping", providing 8 mapping entries in each case to assign 8-bit, 16-bit, and 32-bit parameters to a PDO in an optional order. The total length of the parameters mapped, however, must not exceed 8 bytes.



The process of PDO mapping cannot be applied to all parameters. The mappable parameters are marked correspondingly in the parameter attribute list.

▶ [Parameter attribute list](#) 229

The process of variable PDO mapping only allows the following procedure:

1. Set PDO to "invalid": set bit 31 in the corresponding identifier (0x1400:1 ... 0x1402:1 or 0x1800:1 ... 0x1802:1) to "1".
2. Set PDO mapping to "invalid": set subindex 0 in the mapping parameter (0x1600 ... 0x1602 or 0x1A00 ... 0x1A02) to "0".
3. Set desired PDO mapping via the corresponding mapping entries.
format: 0xiiii:ssll (iiii = hexadecimal index, ss = hexadecimal subindex, ll = hexadecimal data length)
4. Set subindex 0 in the mapping parameter (0x1600 ... 0x1602 or 0x1A00 ... 0x1A02) to a valid value (number of parameters mapped).
5. Reset PDO to "valid": set bit 31 in the corresponding identifier (0x1400:1 ... 0x1402:1 or 0x1800:1 ... 0x1802:1) to "0".

Parameter	Name / value range / [default setting]	Info
0x1600:000	RPDO1 mapping parameter: Highest subindex 0 ... [2] ... 8	Number of objects mapped in RPDO1.
0x1600:001	RPDO1 mapping parameter: Entry 1 0x00000000 ... [0x60400010] ... 0xFFFFFFFF	Mapping entry 1 for RPDO1.
0x1600:002	RPDO1 mapping parameter: Entry 2 0x00000000 ... [0x60420010] ... 0xFFFFFFFF	Mapping entry 2 for RPDO1.
0x1600:003	RPDO1 mapping parameter: Entry 3 0x00000000 ... [0x00000000] ... 0xFFFFFFFF	Mapping entry 3 for RPDO1.
0x1600:004	RPDO1 mapping parameter: Entry 4 0x00000000 ... [0x00000000] ... 0xFFFFFFFF	Mapping entry 4 for RPDO1.
0x1600:005	RPDO1 mapping parameter: Entry 5 0x00000000 ... [0x00000000] ... 0xFFFFFFFF	Mapping entry 5 for RPDO1.
0x1600:006	RPDO1 mapping parameter: Entry 6 0x00000000 ... [0x00000000] ... 0xFFFFFFFF	Mapping entry 6 for RPDO1.
0x1600:007	RPDO1 mapping parameter: Entry 7 0x00000000 ... [0x00000000] ... 0xFFFFFFFF	Mapping entry 7 for RPDO1.
0x1600:008	RPDO1 mapping parameter: Entry 8 0x00000000 ... [0x00000000] ... 0xFFFFFFFF	Mapping entry 8 for RPDO1.
0x1601:000	RPDO2 mapping parameter: Highest subindex 0 ... [0] ... 8	Number of objects mapped in RPDO2.



Configuring the network

CANopen
CANopen data mapping

Parameter	Name / value range / [default setting]	Info
0x1601:001	RPDO2 mapping parameter: Entry 1 0x00000000 ... [0x00000000] ... 0xFFFFFFFF	Mapping entry 1 for RPDO2.
0x1601:002	RPDO2 mapping parameter: Entry 2 0x00000000 ... [0x00000000] ... 0xFFFFFFFF	Mapping entry 2 for RPDO2.
0x1601:003	RPDO2 mapping parameter: Entry 3 0x00000000 ... [0x00000000] ... 0xFFFFFFFF	Mapping entry 3 for RPDO2.
0x1601:004	RPDO2 mapping parameter: Entry 4 0x00000000 ... [0x00000000] ... 0xFFFFFFFF	Mapping entry 4 for RPDO2.
0x1601:005	RPDO2 mapping parameter: Entry 5 0x00000000 ... [0x00000000] ... 0xFFFFFFFF	Mapping entry 5 for RPDO2.
0x1601:006	RPDO2 mapping parameter: Entry 6 0x00000000 ... [0x00000000] ... 0xFFFFFFFF	Mapping entry 6 for RPDO2.
0x1601:007	RPDO2 mapping parameter: Entry 7 0x00000000 ... [0x00000000] ... 0xFFFFFFFF	Mapping entry 7 for RPDO2.
0x1601:008	RPDO2 mapping parameter: Entry 8 0x00000000 ... [0x00000000] ... 0xFFFFFFFF	Mapping entry 8 for RPDO2.
0x1602:000	RPDO3 mapping parameter: Highest subindex 0 ... [0] ... 8	Number of objects mapped in RPDO3.
0x1602:001	RPDO3 mapping parameter: Entry 1 0x00000000 ... [0x00000000] ... 0xFFFFFFFF	Mapping entry 1 for RPDO3.
0x1602:002	RPDO3 mapping parameter: Entry 2 0x00000000 ... [0x00000000] ... 0xFFFFFFFF	Mapping entry 2 for RPDO3.
0x1602:003	RPDO3 mapping parameter: Entry 3 0x00000000 ... [0x00000000] ... 0xFFFFFFFF	Mapping entry 3 for RPDO3.
0x1602:004	RPDO3 mapping parameter: Entry 4 0x00000000 ... [0x00000000] ... 0xFFFFFFFF	Mapping entry 4 for RPDO3.
0x1602:005	RPDO3 mapping parameter: Entry 5 0x00000000 ... [0x00000000] ... 0xFFFFFFFF	Mapping entry 5 for RPDO3.
0x1602:006	RPDO3 mapping parameter: Entry 6 0x00000000 ... [0x00000000] ... 0xFFFFFFFF	Mapping entry 6 for RPDO3.
0x1602:007	RPDO3 mapping parameter: Entry 7 0x00000000 ... [0x00000000] ... 0xFFFFFFFF	Mapping entry 7 for RPDO3.
0x1602:008	RPDO3 mapping parameter: Entry 8 0x00000000 ... [0x00000000] ... 0xFFFFFFFF	Mapping entry 8 for RPDO3.
0x1A00:000	TPDO1 mapping parameter: Highest subindex 0 ... [2] ... 8	Number of objects mapped in TPDO1.
0x1A00:001	TPDO1 mapping parameter: Entry 1 0x00000000 ... [0x60410010] ... 0xFFFFFFFF	Mapping entry 1 for TPDO1.
0x1A00:002	TPDO1 mapping parameter: Entry 2 0x00000000 ... [0x60440010] ... 0xFFFFFFFF	Mapping entry 2 for TPDO1.
0x1A00:003	TPDO1 mapping parameter: Entry 3 0x00000000 ... [0x00000000] ... 0xFFFFFFFF	Mapping entry 3 for TPDO1.
0x1A00:004	TPDO1 mapping parameter: Entry 4 0x00000000 ... [0x00000000] ... 0xFFFFFFFF	Mapping entry 4 for TPDO1.
0x1A00:005	TPDO1 mapping parameter: Entry 5 0x00000000 ... [0x00000000] ... 0xFFFFFFFF	Mapping entry 5 for TPDO1.
0x1A00:006	TPDO1 mapping parameter: Entry 6 0x00000000 ... [0x00000000] ... 0xFFFFFFFF	Mapping entry 6 for TPDO1.
0x1A00:007	TPDO1 mapping parameter: Entry 7 0x00000000 ... [0x00000000] ... 0xFFFFFFFF	Mapping entry 7 for TPDO1.
0x1A00:008	TPDO1 mapping parameter: Entry 8 0x00000000 ... [0x00000000] ... 0xFFFFFFFF	Mapping entry 8 for TPDO1.
0x1A01:000	TPDO2 mapping parameter: Highest subindex 0 ... [0] ... 8	Number of objects mapped in TPDO2.
0x1A01:001	TPDO2 mapping parameter: Entry 1 0x00000000 ... [0x00000000] ... 0xFFFFFFFF	Mapping entry 1 for TPDO2.
0x1A01:002	TPDO2 mapping parameter: Entry 2 0x00000000 ... [0x00000000] ... 0xFFFFFFFF	Mapping entry 2 for TPDO2.
0x1A01:003	TPDO2 mapping parameter: Entry 3 0x00000000 ... [0x00000000] ... 0xFFFFFFFF	Mapping entry 3 for TPDO2.

Configuring the network

CANopen

CANopen service data objects



Parameter	Name / value range / [default setting]	Info
0x1A01:004	TPDO2 mapping parameter: Entry 4 0x00000000 ... [0x00000000] ... 0xFFFFFFFF	Mapping entry 4 for TPDO2.
0x1A01:005	TPDO2 mapping parameter: Entry 5 0x00000000 ... [0x00000000] ... 0xFFFFFFFF	Mapping entry 5 for TPDO2.
0x1A01:006	TPDO2 mapping parameter: Entry 6 0x00000000 ... [0x00000000] ... 0xFFFFFFFF	Mapping entry 6 for TPDO2.
0x1A01:007	TPDO2 mapping parameter: Entry 7 0x00000000 ... [0x00000000] ... 0xFFFFFFFF	Mapping entry 7 for TPDO2.
0x1A01:008	TPDO2 mapping parameter: Entry 8 0x00000000 ... [0x00000000] ... 0xFFFFFFFF	Mapping entry 8 for TPDO2.
0x1A02:000	TPDO3 mapping parameter: Highest subindex 0 ... [0] ... 8	Number of objects mapped in TPDO3.
0x1A02:001	TPDO3 mapping parameter: Entry 1 0x00000000 ... [0x00000000] ... 0xFFFFFFFF	Mapping entry 1 for TPDO3.
0x1A02:002	TPDO3 mapping parameter: Entry 2 0x00000000 ... [0x00000000] ... 0xFFFFFFFF	Mapping entry 2 for TPDO3.
0x1A02:003	TPDO3 mapping parameter: Entry 3 0x00000000 ... [0x00000000] ... 0xFFFFFFFF	Mapping entry 3 for TPDO3.
0x1A02:004	TPDO3 mapping parameter: Entry 4 0x00000000 ... [0x00000000] ... 0xFFFFFFFF	Mapping entry 4 for TPDO3.
0x1A02:005	TPDO3 mapping parameter: Entry 5 0x00000000 ... [0x00000000] ... 0xFFFFFFFF	Mapping entry 5 for TPDO3.
0x1A02:006	TPDO3 mapping parameter: Entry 6 0x00000000 ... [0x00000000] ... 0xFFFFFFFF	Mapping entry 6 for TPDO3.
0x1A02:007	TPDO3 mapping parameter: Entry 7 0x00000000 ... [0x00000000] ... 0xFFFFFFFF	Mapping entry 7 for TPDO3.
0x1A02:008	TPDO3 mapping parameter: Entry 8 0x00000000 ... [0x00000000] ... 0xFFFFFFFF	Mapping entry 8 for TPDO3.

8.4.10 CANopen service data objects

Service data objects (SDOs) make it possible to read and write all parameters of the inverter via CANopen.

Details

- Two independent SDO channels are provided at the same time. SDO channel 1 is always active. SDO channel 2 can be activated via [0x2301:005 \(PAR 510/005\)](#).
- The identifiers for SDO1 and SDO2 are generated from the basic identifier (in compliance with the "Predefined Connection Set") and the node address set.
- An SDO is always transmitted with confirmation, i. e. the reception of an SDO frame is acknowledged by the receiver.

Structure of the SDO frame user data

The user data are shown in Motorola format:

1st byte	2nd byte	3rd byte	4th byte	5th byte	6th byte	7th byte	8th byte
Command	Index		Subindex	Data 1	Data 2	Data 3	Data 4
See table below.	LOW byte	HIGH byte		LOW word		HIGH word	
	Address of the parameter to be read or written.			LOW byte	HIGH byte	LOW byte	HIGH byte

The following commands can be transmitted or received for writing and reading the parameters:

Command	1st byte		Data length	Info
	hex	dec		
Write request	0x23	35	4 bytes	Writing of a parameter to the inverter.
	0x2B	43	2 bytes	
	0x2F	47	1 byte	
	0x21	33	Block	
Write response	0x60	96	4 bytes	Inverter acknowledges a write request.
Read request	0x40	64	4 bytes	Reading of a parameter from the inverter.



Command	1st byte		Data length	Info
	hex	dec		
Read response	0x43	67	4 bytes	Inverter response to a read request with the current parameter value.
	0x4B	75	2 bytes	
	0x4F	79	1 byte	
	0x41	65	Block	
Error response	0x80	128	4 bytes	Inverter response to the incorrect execution of the read/write request.

More precisely, the command byte comprises the following information:

Command	1st byte							
	Command specifier (cs)			Toggle (t)	Length*		e	s
	Bit 7	Bit 6	Bit 5	Bit 4	Bit 3	Bit 2	Bit 1	Bit 0
Write request	0	0	1	0	0/1	0/1	1	1
Write response	0	1	1	0	0	0	0	0
Read request	0	1	0	0	0	0	0	0
Read response	0	1	0	0	0/1	0/1	1	1
Error response	1	0	0	0	0	0	0	0

*Bit coding of the length: 00 = 4 bytes, 01 = 3 bytes, 10 = 2 bytes, 11 = 1 byte
e: expedited (shortened block service)
s: segmented (normal block service)

More commands are defined in the DS301 V4.02 CANopen specification (e.g. segmented transfer).

Maximally 4 bytes are available for parameter value entries. Depending on the data format, they are assigned as follows:

5th byte	6th byte	7th byte	8th byte
Parameter value (1 byte)	0x00	0x00	0x00
Parameter value (2 bytes)		0x00	0x00
LOW byte	HIGH byte		
Parameter value (4 bytes)			
LOW word		HIGH word	
LOW byte	HIGH byte	LOW byte	HIGH byte



The parameter attribute list in the annex also specifies a scaling factor. The scaling factor is relevant to the transmission of parameter values which are represented with one or several decimal positions in the parameter list. If the scaling factor is > 1, before the transmission, the value must be multiplied with the scaling factor specified, so that the value can be transferred completely (as an integer value). On the SDO-client side, the integer value must then be divided by the scaling factor again, in order to receive the original value with decimal positions.

▶ [Parameter attribute list](#) □ 229

Parameter	Name / value range / [default setting]	Info
0x1200:000	SDO1 server parameter: Highest subindex • Read only	
0x1200:001	SDO1 server parameter: COB-ID client -> server (RX) • Read only	Display of the receive identifier for SDO server channel 1 (basic SDO channel). • According to DS301 V4.02, the basic SDO channel can neither be changed nor deactivated.
0x1200:002	SDO1 server parameter: COB-ID server -> client (TX) • Read only	Display of the transmit identifier for SDO server channel 1 (basic SDO channel). • According to DS301 V4.02, the basic SDO channel can neither be changed nor deactivated.
0x1201:000	SDO2 server parameter: Highest subindex • Read only	

Configuring the network

CANopen

CANopen error responses



Parameter	Name / value range / [default setting]	Info
0x1201:001	SDO2 server parameter: COB-ID client -> server (RX) 0x00000000 ... [0x80000640] ... 0xFFFFFFFF	Specification of the receive identifier for SDO server channel 2. <ul style="list-style-type: none"> If SDO server channel 2 is activated via 0x2301:005 (PAR 510/005), this parameter is set to the value "node address + 0x640". This default setting can be changed.
0x1201:002	SDO2 server parameter: COB-ID server -> client (TX) 0x00000000 ... [0x800005C0] ... 0xFFFFFFFF	Specification of the transmit identifier for SDO server channel 2. <ul style="list-style-type: none"> If SDO server channel 2 is activated via 0x2301:005 (PAR 510/005), this parameter is set to the value "node address + 0x5C0". This default setting can be changed.
0x1201:003	SDO2 server parameter: SDO client node ID 1 ... [0] ... 127	Specification of the node address for the SDO client.
0x2301:005 (PAR 510/005)	CANopen settings: Activate SDO2 channel (CANopen sett.: SDO2 config.)	1 = activate SDO server channel 2.
	0 Not active	
	1 Active	

8.4.11 CANopen error responses

The response to CANopen errors such as missing PDOs or heartbeat frames can be configured via the following parameters.

Parameter	Name / value range / [default setting]	Info
0x1029:000	Error behavior: Highest subindex <ul style="list-style-type: none"> Read only 	
0x1029:001	Error behavior: Communication error	Selection of the NMT state to which the inverter is to change automatically if a failure of a CANopen node or an internal error is detected in the "Operational" state. These also include the following communication errors: <ul style="list-style-type: none"> Change-over of the CAN interface to the "Bus-off" state. Occurrence of a "Life Guarding Event". Occurrence of a "Heartbeat Event".
	0 Status -> Pre-operational	In the "Pre-operational" state, network management, sync, and emergency telegrams as well as parameter data can be received; process data, however, are ignored.
	1 No status change	
	2 Status -> Stopped	In the "Stopped" state, only network management telegrams can be received.
0x2857:001	CANopen monitoring: RPDO1-Timeout <ul style="list-style-type: none"> For possible settings see description for 0x2D45:001 (PAR 310/001). 94 	Selection of the response to triggering the RPDO1 time monitoring.
	3 Error	
0x2857:002	CANopen monitoring: RPDO2-Timeout <ul style="list-style-type: none"> For possible settings see description for 0x2D45:001 (PAR 310/001). 94 	Selection of the response to triggering the RPDO2 time monitoring.
	3 Error	
0x2857:003	CANopen monitoring: RPDO3-Timeout <ul style="list-style-type: none"> For possible settings see description for 0x2D45:001 (PAR 310/001). 94 	Selection of the response to triggering the RPDO3 time monitoring.
	3 Error	
0x2857:005	CANopen monitoring: Heartbeat-Timeout Consumer 1 <ul style="list-style-type: none"> For possible settings see description for 0x2D45:001 (PAR 310/001). 94 	Selection of the response with "Heartbeat Event" in consumer 1.
	3 Error	
0x2857:006	CANopen monitoring: Heartbeat-Timeout Consumer 2 <ul style="list-style-type: none"> For possible settings see description for 0x2D45:001 (PAR 310/001). 94 	Selection of the response with "Heartbeat Event" in consumer 2.
	3 Error	
0x2857:007	CANopen monitoring: Heartbeat-Timeout Consumer 3 <ul style="list-style-type: none"> For possible settings see description for 0x2D45:001 (PAR 310/001). 94 	Selection of the response with "Heartbeat Event" in consumer 3.
	3 Error	



Parameter	Name / value range / [default setting]	Info
0x2857:008	CANopen monitoring: Heartbeat-Timeout Consumer 4 • For possible settings see description for 0x2D45:001 (PAR 310/001) . 94	Selection of the response with "Heartbeat Event" in consumer 4.
	3 Error	
0x2857:010	CANopen monitoring: "Bus-off" state change • For possible settings see description for 0x2D45:001 (PAR 310/001) . 94	Selection of the response to changing to the "Bus off" state.
	2 Trouble	
0x2857:011	CANopen monitoring: Warning	Selection of the response that is executed in the case of too many incorrectly sent or received CAN telegrams (> 96).
	0 No response	
	1 Warning	
	2 Trouble	
	3 Error	

8.4.12 CANopen diagnostic counter

The following parameters serve to diagnose the communication activities between the inverter and the CANopen network. The counters are free-running, i. e. when the maximum value has been reached, the respective counter starts at 0 again.

Parameter	Name / value range / [default setting]	Info
0x230A:000	CANopen statistics: Highest subindex • Read only	Number of frame and error counters.
0x230A:001 (PAR 580/001)	CANopen statistics: PDO1 received (CAN counter: PDO1 received) • Read only	Display of the number of PDO1 telegrams received.
0x230A:002 (PAR 580/002)	CANopen statistics: PDO2 received (CAN counter: PDO2 received) • Read only	Display of the number of PDO2 telegrams received.
0x230A:003 (PAR 580/003)	CANopen statistics: PDO3 received (CAN counter: PDO3 received) • Read only	Display of the number of PDO3 telegrams received.
0x230A:005 (PAR 580/005)	CANopen statistics: PDO1 transmitted (CAN counter: PDO1 transmitted) • Read only	Display of the number of PDO1 telegrams sent.
0x230A:006 (PAR 580/006)	CANopen statistics: PDO2 transmitted (CAN counter: PDO2 transmitted) • Read only	Display of the number of PDO2 telegrams sent.
0x230A:007 (PAR 580/007)	CANopen statistics: PDO3 transmitted (CAN counter: PDO3 transmitted) • Read only	Display of the number of PDO3 telegrams sent.
0x230A:009 (PAR 580/009)	CANopen statistics: SDO1 telegrams (CAN counter: SDO1 counter) • Read only	Display of the number of SDO1 telegrams.
0x230A:010 (PAR 580/010)	CANopen statistics: SDO2 telegrams (CAN counter: SDO2 counter) • Read only	Display of the number of SDO2 telegrams.
0x230B (PAR 518)	CANopen error counter (CAN error counter) • Read only	Display of the total number of CAN faults that have occurred.

Configuring the network

CANopen
CANopen LED status displays



8.4.13 CANopen LED status displays

Information about the CAN bus status can be obtained quickly via the "CAN-RUN" and "CAN-ERR" LED displays on the front of the inverter.

The meaning can be seen from the tables below.

Inverter not active on the CAN bus (yet)

LED display	Meaning
 (CAN-ERR is permanently lit)	Inverter not active on the CAN bus / "Bus Off" state.
 (CAN-RUN and CAN-ERR are flickering)	Automatic baud rate detection active.

Inverter active on the CAN bus

The "CAN-RUN" LED indicates the CANopen state:

LED display	CANopen state
 (CAN-RUN is blinking every 0.2 seconds)	Pre-Operational
 (CAN-RUN and CAN-ERR are flickering)	Operational
 (CAN-RUN blinks every second)	Stopped

The "CAN-ERR" LED indicates a CANopen error:

LED display	CANopen error
 (CAN-ERR blinks once, then goes off for 1 second)	Warning Limit reached
 (CAN-ERR blinks twice, then goes off for 1 second)	Node Guard Event
 (CAN-ERR blinks three times, then goes off for 1 second)	Sync message error (only possible in the "Operational" state)

8.4.14 Resetting the CANopen interface

The following parameter can be used to restart or stop CAN communication. Optionally it is also possible to reset all CAN parameters to the default state.

Parameter	Name / value range / [default setting]	Info
0x2300 (PAR 508)	Activate network (Activ. network) • Setting can only be changed if controller inhibit is active.	Restart / stop CAN communication. • After successful execution, the value 0 is shown.
	0 No action/no error	Only status feedback.
	1 Restart with current values	Restart CAN communication with the current values.
	2 Restart with standard values	Restart CAN communication with the standard values of the CAN parameters (0x1000 ... 0x1FFF and 0x2301). The standard values of these parameters are saved in the memory module.
	5 Stop network communication	Stop CAN communication. • The "Stop Remote Node" NMT command is executed. After successful execution of this command, only the reception of network management frames is possible.
	10 In progress	Only status feedback.
	11 Action cancelled	
	12 Error	



8.5 Modbus

Modbus is an internationally approved, asynchronous, serial communication protocol, designed for commercial and industrial automation applications.



Information about the dimensioning of a Modbus network can be found in the configuration document for the inverter.

Preconditions

- Control unit (CU) of the inverter is provided with Modbus/CANopen.
- Modbus/CANopen selector at the inverter front is set to "Modbus".

8.5.1 Modbus introduction

- The process of data transmission distinguishes between three different operating modes: Modbus ASCII, Modbus RTU, and Modbus TCP. The inverter supports the Modbus RTU operating mode ("Remote Terminal Unit").
- The Modbus protocol is based on a master/slave architecture where the inverter always works as slave.
- The Modbus network only permits one master (at a time) sending commands and requests. The master is also the sole instance to be allowed to initiate Modbus communication. No direct communication takes place between the slaves.
- The physical interface corresponds to TIA/EIA-485-A which is very common and suitable for the industrial environment. This interface enables baud rates from 2400 to 115200 kbps.
- The inverter supports Modbus function codes 3, 6, 16 (0x10) and 23 (0x17).

8.5.2 Modbus node address

Each network node must be provided with a unique node address.

Details

- The node address can be set in [0x2321:001 \(PAR 510/001\)](#).
- The setting that is active when the inverter is switched on is the effective setting.
- The node address 0 is reserved for messages to all nodes ("Broadcast") .
- The active node address is shown in [0x2322:001 \(PAR 511/001\)](#).

Parameter	Name / value range / [default setting]	Info
0x2321:001 (PAR 510/001)	Modbus settings: Node ID (Modbus sett.: Node ID) 1 ... [1] ... 247	Setting of the node address. <ul style="list-style-type: none"> • A change in the node address only becomes effective after a restart of Modbus communication.
0x2323 (PAR 509)	DIP switch position (DIP switch) <ul style="list-style-type: none"> • Read only 	Display of the DIP switch setting at the last mains power-on.

Configuring the network

Modbus
Modbus baud rate

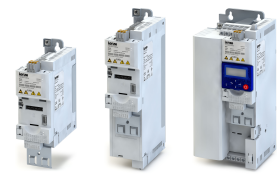

8.5.3 Modbus baud rate

All network nodes must be set to the same baud rate.

Details

- The node address can be set in [0x2321:002 \(PAR 510/002\)](#).
- If the automatic baud rate detection function is activated, the first 5 ... 10 messages are lost after switch-on.
- The active baud rate is shown in [0x2322:002 \(PAR 511/002\)](#).

Parameter	Name / value range / [default setting]	Info
0x2321:002 (PAR 510/002)	Modbus settings: Baud rate (Modbus sett.: Baud rate)	Setting of the baud rate. <ul style="list-style-type: none"> • A change in the baud rate only becomes effective after a restart of Modbus communication. • If the automatic baud rate detection function is activated, the first 5 ... 10 messages are lost after switch-on.
	0 Automatic	
	1 2400 kbps	
	2 4800 kbps	
	3 9600 kbps	
	4 19200 kbps	
	5 38400 kbps	
	6 57600 kbps	
7 115200 kbps		
0x2323 (PAR 509)	DIP switch position (DIP switch) <ul style="list-style-type: none"> • Read only 	Display of the DIP switch setting at the last mains power-on.

8.5.4 Modbus data format

Parameter	Name / value range / [default setting]	Info
0x2321:003 (PAR 510/003)	Modbus settings: Data format (Modbus sett.: Data format)	Definition of the parity and stop bits.
	0 Automatic	Automatic data format detection. <ul style="list-style-type: none"> • With this setting, the first 5 ... 10 messages are lost after switch-on.
	1 8, E, 1	8 data bits, even parity, 1 stop bit
	2 8, O, 1	8 data bits, odd parity, 1 stop bit
3 8, N, 2	8 data bits, no parity bit, 2 stop bits	
0x2323 (PAR 509)	DIP switch position (DIP switch) <ul style="list-style-type: none"> • Read only 	Display of the DIP switch setting at the last mains power-on.

8.5.5 Modbus time-out monitoring

Parameter	Name / value range / [default setting]	Info
0x2858:001 (PAR 515/001)	Modbus monitoring: Response to time-out (Modbus monit.: Time-out action) <ul style="list-style-type: none"> • For possible settings see description for 0x2D45:001 (PAR 310/001). 94 	Selection of the response executed if no valid messages have been received via the Modbus for a longer time than the time-out period set in 0x2858:2.
	3 Error	
0x2858:002 (PAR 515/002)	Modbus monitoring: Time-out (Modbus monit.: Timeout) 0.0 ... [2.0] ... 300.0 s	Time-out period for monitoring the message reception via Modbus.

8.5.6 Modbus diagnostics

The following parameters serve to diagnose the communication activities between the inverter and the Modbus network.

Parameter	Name / value range / [default setting]	Info
0x2322:001 (PAR 511/001)	Active Modbus settings: Node ID (Active sett.: Node ID) <ul style="list-style-type: none"> • Read only 	Display of the active node address.
0x2322:002 (PAR 511/002)	Active Modbus settings: Baud rate (Active sett.: Baud rate) <ul style="list-style-type: none"> • Read only 	Display of the active baud rate.



Configuring the network

Modbus Modbus diagnostics

Parameter	Name / value range / [default setting]	Info
0x2322:003 (PAR 511/003)	Active Modbus settings: Data format (Active sett.: Data format) • Read only	Display of the active data format.
0x232A:001 (PAR 580/001)	Modbus statistics: Messages received (Modbus counter: Messages received) • Read only	Display of the total number of messages received. • This counter counts both valid and invalid messages. • After the maximum value has been reached, the counter starts again "0".
0x232A:002 (PAR 580/002)	Modbus statistics: Valid messages received (Modbus counter: Val. mess. rec.) • Read only	Display of the number of valid messages received. • After the maximum value has been reached, the counter starts again "0".
0x232A:003 (PAR 580/003)	Modbus statistics: Messages with exceptions (Modbus counter: Mess. w. exc.) • Read only	Display of the number of messages with exceptions that have been received. • After the maximum value has been reached, the counter starts again "0".
0x232A:004 (PAR 580/004)	Modbus statistics: Messages with errors (Modbus counter: Mess. with errors) • Read only	Display of the number of messages received with a faulty data integrity (parity, CRC). • After the maximum value has been reached, the counter starts again "0".
0x232A:005 (PAR 580/005)	Modbus statistics: Messages sent (Modbus counter: Messages sent) • Read only	Display of the total number of messages sent. • After the maximum value has been reached, the counter starts again "0".
0x232E:001 (PAR 583/001)	Modbus diagnostics of last RX data: Offset (RX data diagnostics: RX data offset) 0 ... [0] ... 240	For purposes of diagnostics, the last message received (max. 16 bytes) is shown in 0x232E:1 ... 16. For longer messages, an offset can be specified here, indicating from which byte of the message the display of the 16 bytes is to start.
0x232E:002 (PAR 583/002)	Modbus diagnostics of last RX data: Data byte 0 (RX data diagnostics: Last RxD byte0) • Read only	Display of the message received last.
0x232E:003 (PAR 583/003)	Modbus diagnostics of last RX data: Data byte 1 (RX data diagnostics: Last RxD byte2) • Read only	
0x232E:004 (PAR 583/004)	Modbus diagnostics of last RX data: Data byte 2 (RX data diagnostics: Last RxD byte4) • Read only	
0x232E:005 (PAR 583/005)	Modbus diagnostics of last RX data: Data byte 3 (RX data diagnostics: Last RxD byte6) • Read only	
0x232E:006 (PAR 583/006)	Modbus diagnostics of last RX data: Data byte 4 (RX data diagnostics: Last RxD byte8) • Read only	
0x232E:007 (PAR 583/007)	Modbus diagnostics of last RX data: Data byte 5 (RX data diagnostics: Last RxD byte10) • Read only	
0x232E:008 (PAR 583/008)	Modbus diagnostics of last RX data: Data byte 6 (RX data diagnostics: Last RxD byte12) • Read only	
0x232E:009 (PAR 583/009)	Modbus diagnostics of last RX data: Data byte 7 (RX data diagnostics: Last RxD byte14) • Read only	
0x232E:010 (PAR 583/010)	Modbus diagnostics of last RX data: Data byte 8 (RX data diagnostics: Last RxD byte16) • Read only	
0x232E:011 (PAR 583/011)	Modbus diagnostics of last RX data: Data byte 9 (RX data diagnostics: Last RxD byte18) • Read only	
0x232E:012 (PAR 583/012)	Modbus diagnostics of last RX data: Data byte 10 (RX data diagnostics: Last RxD byte20) • Read only	
0x232E:013 (PAR 583/013)	Modbus diagnostics of last RX data: Data byte 11 (RX data diagnostics: Last RxD byte22) • Read only	

Configuring the network

Modbus
Modbus diagnostics



Parameter	Name / value range / [default setting]	Info
0x232E:014 (PAR 583/014)	Modbus diagnostics of last RX data: Data byte 12 (RX data diagnostics: Last RxD byte24) • Read only	
0x232E:015 (PAR 583/015)	Modbus diagnostics of last RX data: Data byte 13 (RX data diagnostics: Last RxD byte26) • Read only	
0x232E:016 (PAR 583/016)	Modbus diagnostics of last RX data: Data byte 14 (RX data diagnostics: Last RxD byte28) • Read only	
0x232E:017 (PAR 583/017)	Modbus diagnostics of last RX data: Data byte 15 (RX data diagnostics: Last RxD byte30) • Read only	
0x232F:001 (PAR 585/001)	Modbus diagnostics of last TX data: Offset (TX data diagnostics: TX data offset) 0 ... [0] ... 240	For purposes of diagnostics, the last message sent (max. 16 bytes) is shown in 0x232F:1 ... 16. For longer messages, an offset can be specified here, indicating from which byte of the message the display of the 16 bytes is to start.
0x232F:002 (PAR 585/002)	Modbus diagnostics of last TX data: Data byte 0 (TX data diagnostics: Last TxD byte0) • Read only	Display of the message sent last.
0x232F:003 (PAR 585/003)	Modbus diagnostics of last TX data: Data byte 1 (TX data diagnostics: Last TxD Byte1) • Read only	
0x232F:004 (PAR 585/004)	Modbus diagnostics of last TX data: Data byte 2 (TX data diagnostics: Last TxD byte2) • Read only	
0x232F:005 (PAR 585/005)	Modbus diagnostics of last TX data: Data byte 3 (TX data diagnostics: Last TxD byte3) • Read only	
0x232F:006 (PAR 585/006)	Modbus diagnostics of last TX data: Data byte 4 (TX data diagnostics: Last TxD byte4) • Read only	
0x232F:007 (PAR 585/007)	Modbus diagnostics of last TX data: Data byte 5 (TX data diagnostics: Last TxD byte5) • Read only	
0x232F:008 (PAR 585/008)	Modbus diagnostics of last TX data: Data byte 6 (TX data diagnostics: Last TxD byte6) • Read only	
0x232F:009 (PAR 585/009)	Modbus diagnostics of last TX data: Data byte 7 (TX data diagnostics: Last TxD byte7) • Read only	
0x232F:010 (PAR 585/010)	Modbus diagnostics of last TX data: Data byte 8 (TX data diagnostics: Last TxD byte8) • Read only	
0x232F:011 (PAR 585/011)	Modbus diagnostics of last TX data: Data byte 9 (TX data diagnostics: Last TxD byte9) • Read only	
0x232F:012 (PAR 585/012)	Modbus diagnostics of last TX data: Data byte 10 (TX data diagnostics: Last TxD byte10) • Read only	
0x232F:013 (PAR 585/013)	Modbus diagnostics of last TX data: Data byte 11 (TX data diagnostics: Last TxD byte11) • Read only	
0x232F:014 (PAR 585/014)	Modbus diagnostics of last TX data: Data byte 12 (TX data diagnostics: Last TxD byte12) • Read only	
0x232F:015 (PAR 585/015)	Modbus diagnostics of last TX data: Data byte 13 (TX data diagnostics: Last TxD byte13) • Read only	
0x232F:016 (PAR 585/016)	Modbus diagnostics of last TX data: Data byte 14 (TX data diagnostics: Last TxD byte14) • Read only	



Parameter	Name / value range / [default setting]	Info
0x232F:017 (PAR 585/017)	Modbus diagnostics of last TX data: Data byte 15 (TX data diagnostics: Last TxD byte15) • Read only	

8.5.7 Modbus function codes

The mode of access to inverter data (parameters) is controlled via function codes.

Details

The inverter supports the following function codes:

Function code	Function name	Description
3	0x03	Read Holding Registers
6	0x06	Preset Single Register
16	0x10	Preset Multiple Registers
23	0x17	Read/Write 4X Registers

Addressing

- The function codes listed above exclusively refer to 4X registers in Modbus addressing.
- All data in Lenze drives can only be accessed via 4X registers, i.e. via register addresses starting from 40001.
- The 4xxx reference is implicit, i. e. given by the function code used. In the frame therefore the leading 4 is omitted in the addressing process.
- The numbering of the registers starts with 1; addressing, however, starts with 0. Therefore, for instance, the address 0 is used in the frame when register 40001 is read.

Telegram structure

Communication is established on the basis of the central medium access method. Communication is always started by a master request. The inverter (slave) then either gives a valid response or outputs an error code (provided that the request has been received and evaluated as a valid Modbus frame). Error causes can be invalid CRC checksums, function codes that are not supported, or impermissible data access.

All Modbus frames have the following basic structure:

- A "frame" consists of a PDU (Protocol Data Unit) and an ADU (Application Data Unit).
- The PDU contains the function code and the data belonging to the function code.
- The ADU serves the purposes of addressing and error detection.
- The data are represented in Big Endian format (most significant byte first).

ADU (Application Data Unit)			
Slave address	Function code	Data	Checksum (CRC)
	PDU (Protocol Data Unit)		

Error codes

Error code	Name	Cause(s)
0x01	Invalid function code	The function code is not supported by the inverter, or the inverter is in a state in which the request is not permissible or in which it cannot be processed.
0x02	Invalid data address	The combination of a start address and the length of the data to be transmitted is invalid. Example: If you have a slave with 100 registers, the first register has the address 0 and the last register has the address 99. If there is a request of four registers now, from the start address 96, the request can be processed successfully (for registers 96, 97, 98, and 99). If, however, five registers from the start address 96 are queried, this error code is returned, since the slave has no register with the address 100.
0x03	Invalid data value	The cause, however, is not that a (parameter) value is written outside the valid setting range. As a matter of principle, the Modbus protocol has no information on valid setting ranges of individual registers or their meaning.
0x04	Slave device failure	A non-correctable error has occurred while the request was processed in the inverter.

Configuring the network

Modbus
Modbus data mapping



8.5.8 Modbus data mapping

The process of data mapping is used for defining which Modbus registers read or write to which inverter parameters.

Details

- There are fixedly defined Modbus registers for common control and status words, which are located in coherent blocks, in order to facilitate communication with OPC servers and other Modbus masters. In order to access all relevant data of the inverter, only a minimum number of commands is required.
- In addition, 24 registers are provided for variable mapping, i. e. free assignment to inverter parameters.

Predefined Modbus control registers

- These registers are provided with write and read access.
- The cross-reference in column 2 leads to the detailed parameter description.

Modbus registers	Permanently assigned parameter	
	Address	Name
42101	0x400B:001 (PAR 592/001)	AC Drive control word
42102	0x400B:005 (PAR 592/005)	Network setpoint frequency [0.01 Hz]
42103	0x4008:003 (PAR 590/003)	NETWordIN2
42104	0x400B:001 (PAR 592/001)	NETWordIN3
42105	0x400B:007 (PAR 592/007)	Network process controller setpoint
42106	0x6071	Target torque
42107	0x4008:001 (PAR 590/001)	NETWordIN1
42108	0x4008:004 (PAR 590/004)	NETWordIN4
42109 ... 42121	-	Reserved

Predefined Modbus status registers

- These registers are only provided with read access.
- The cross-reference in column 2 leads to the detailed parameter description.

Modbus registers	Permanently assigned parameter	
	Address	Name
42001	0x400C:001 (PAR 593/001)	AC Drive status word
42002	0x400C:006 (PAR 593/006)	Actual frequency [0.01 Hz]
42003	0x603F (PAR 150)	Error code
42004	0x400C:005 (PAR 593/005)	Drive status
42005	0x2D89 (PAR 106)	Actual motor voltage
42006	0x2D88 (PAR 104)	Actual motor current
42007	0x6078 (PAR 103)	Current actual value
42008	0x2DA2:002 (PAR 108/002)	Apparent power (42008 = High Word, 42009 = Low Word)
42009		
42010	0x2D84:001 (PAR 117/001)	Actual value
42011	0x2D87 (PAR 105)	DC-bus voltage
42012	0x60FD (PAR 118)	Digital inputs
42013	0x6077 (PAR 107)	Torque actual value
42014 ... 42021	-	Reserved

Variable mapping

- Via 0x232B:1 ... 24, 24 registers can be mapped variably to parameters of the inverter. Format: 0xiiiiss00 (iiii = hexadecimal index, ss = hexadecimal subindex)
- The display of the internal Modbus register numbers in 0x232C:1 ... 24 is generated automatically. Since 32-bit parameters require two registers, there is no 1:1 assignment.
- For the mappable registers, a CRC (Cyclic Redundancy Check) is executed. The checksum determined is shown in [0x232D \(PAR 532\)](#). The user can read this "validation code" and use it for comparison in the Modbus master. In this way it can be checked whether the inverter currently queried is configured correctly for the respective application.



Configuring the network

Modbus Modbus data mapping

Parameter	Name / value range / [default setting]	Info
0x232B:001 (PAR 530/001)	Modbus parameter mapping: Parameter 1 (Para. mapping: Parameter 1) 0x00000000 ... [0x00000000] ... 0xFFFFFFFF00	Mapping entry for Modbus register 40103.
0x232B:002 (PAR 530/002)	Modbus parameter mapping: Parameter 2 (Para. mapping: Parameter 2) 0x00000000 ... [0x00000000] ... 0xFFFFFFFF00	Mapping entry for Modbus register 40105.
0x232B:003 (PAR 530/003)	Modbus parameter mapping: Parameter 3 (Para. mapping: Parameter 3) 0x00000000 ... [0x00000000] ... 0xFFFFFFFF00	Mapping entry for Modbus register 40107.
0x232B:004 (PAR 530/004)	Modbus parameter mapping: Parameter 4 (Para. mapping: Parameter 4) 0x00000000 ... [0x00000000] ... 0xFFFFFFFF00	Mapping entry for Modbus register 40109.
0x232B:005 (PAR 530/005)	Modbus parameter mapping: Parameter 5 (Para. mapping: Parameter 5) 0x00000000 ... [0x00000000] ... 0xFFFFFFFF00	Mapping entry for Modbus register 40111.
0x232B:006 (PAR 530/006)	Modbus parameter mapping: Parameter 6 (Para. mapping: Parameter 6) 0x00000000 ... [0x00000000] ... 0xFFFFFFFF00	Mapping entry for Modbus register 40113.
0x232B:007 (PAR 530/007)	Modbus parameter mapping: Parameter 7 (Para. mapping: Parameter 7) 0x00000000 ... [0x00000000] ... 0xFFFFFFFF00	Mapping entry for Modbus register 40115.
0x232B:008 (PAR 530/008)	Modbus parameter mapping: Parameter 8 (Para. mapping: Parameter 8) 0x00000000 ... [0x00000000] ... 0xFFFFFFFF00	Mapping entry for Modbus register 40117.
0x232B:009 (PAR 530/009)	Modbus parameter mapping: Parameter 9 (Para. mapping: Parameter 9) 0x00000000 ... [0x00000000] ... 0xFFFFFFFF00	Mapping entry for Modbus register 40119.
0x232B:010 (PAR 530/010)	Modbus parameter mapping: Parameter 10 (Para. mapping: Parameter 10) 0x00000000 ... [0x00000000] ... 0xFFFFFFFF00	Mapping entry for Modbus register 40121.
0x232B:011 (PAR 530/011)	Modbus parameter mapping: Parameter 11 (Para. mapping: Parameter 11) 0x00000000 ... [0x00000000] ... 0xFFFFFFFF00	Mapping entry for Modbus register 40123.
0x232B:012 (PAR 530/012)	Modbus parameter mapping: Parameter 12 (Para. mapping: Parameter 12) 0x00000000 ... [0x00000000] ... 0xFFFFFFFF00	Mapping entry for Modbus register 40125.
0x232B:013 (PAR 530/013)	Modbus parameter mapping: Parameter 13 (Para. mapping: Parameter 13) 0x00000000 ... [0x00000000] ... 0xFFFFFFFF00	Mapping entry for Modbus register 40127.
0x232B:014 (PAR 530/014)	Modbus parameter mapping: Parameter 14 (Para. mapping: Parameter 14) 0x00000000 ... [0x00000000] ... 0xFFFFFFFF00	Mapping entry for Modbus register 40129.
0x232B:015 (PAR 530/015)	Modbus parameter mapping: Parameter 15 (Para. mapping: Parameter 15) 0x00000000 ... [0x00000000] ... 0xFFFFFFFF00	Mapping entry for Modbus register 40131.
0x232B:016 (PAR 530/016)	Modbus parameter mapping: Parameter 16 (Para. mapping: Parameter 16) 0x00000000 ... [0x00000000] ... 0xFFFFFFFF00	Mapping entry for Modbus register 40133.
0x232B:017 (PAR 530/017)	Modbus parameter mapping: Parameter 17 (Para. mapping: Parameter 17) 0x00000000 ... [0x00000000] ... 0xFFFFFFFF00	Mapping entry for Modbus register 40135.
0x232B:018 (PAR 530/018)	Modbus parameter mapping: Parameter 18 (Para. mapping: Parameter 18) 0x00000000 ... [0x00000000] ... 0xFFFFFFFF00	Mapping entry for Modbus register 40137.
0x232B:019 (PAR 530/019)	Modbus parameter mapping: Parameter 19 (Para. mapping: Parameter 19) 0x00000000 ... [0x00000000] ... 0xFFFFFFFF00	Mapping entry for Modbus register 40139.
0x232B:020 (PAR 530/020)	Modbus parameter mapping: Parameter 20 (Para. mapping: Parameter 20) 0x00000000 ... [0x00000000] ... 0xFFFFFFFF00	Mapping entry for Modbus register 40141.
0x232B:021 (PAR 530/021)	Modbus parameter mapping: Parameter 21 (Para. mapping: Parameter 21) 0x00000000 ... [0x00000000] ... 0xFFFFFFFF00	Mapping entry for Modbus register 40143.

Configuring the network

Modbus

Modbus data mapping



Parameter	Name / value range / [default setting]	Info
0x232B:022 (PAR 530/022)	Modbus parameter mapping: Parameter 22 (Para. mapping: Parameter 22) 0x00000000 ... [0x00000000] ... 0xFFFFFFFF	Mapping entry for Modbus register 40145.
0x232B:023 (PAR 530/023)	Modbus parameter mapping: Parameter 23 (Para. mapping: Parameter 23) 0x00000000 ... [0x00000000] ... 0xFFFFFFFF	Mapping entry for Modbus register 40147.
0x232B:024 (PAR 530/024)	Modbus parameter mapping: Parameter 24 (Para. mapping: Parameter 24) 0x00000000 ... [0x00000000] ... 0xFFFFFFFF	Mapping entry for Modbus register 40149.
0x232C:001 (PAR 531/001)	Modbus register assignment: Register 1 (Reg. assigned: Register 1) • Read only	Display of the internal Modbus register number starting from which the parameter mapped in 0x232B:1 is stored. • For the first parameter mapped, always 2500.
0x232C:002 (PAR 531/002)	Modbus register assignment: Register 2 (Reg. assigned: Register 2) • Read only	Display of the internal Modbus register number starting from which the parameter mapped in 0x232B:2 is stored. • 2500 + offset. The offset results from the data types of the previously mapped parameters.
0x232C:003 (PAR 531/003)	Modbus register assignment: Register 3 (Reg. assigned: Register 3) • Read only	Display of the internal Modbus register number starting from which the parameter mapped in 0x232B:3 is stored. • 2500 + offset. The offset results from the data types of the previously mapped parameters.
0x232C:004 (PAR 531/004)	Modbus register assignment: Register 4 (Reg. assigned: Register 4) • Read only	Display of the internal Modbus register number starting from which the parameter mapped in 0x232B:4 is stored. • 2500 + offset. The offset results from the data types of the previously mapped parameters.
0x232C:005 (PAR 531/005)	Modbus register assignment: Register 5 (Reg. assigned: Register 5) • Read only	Display of the internal Modbus register number starting from which the parameter mapped in 0x232B:5 is stored. • 2500 + offset. The offset results from the data types of the previously mapped parameters.
0x232C:006 (PAR 531/006)	Modbus register assignment: Register 6 (Reg. assigned: Register 6) • Read only	Display of the internal Modbus register number starting from which the parameter mapped in 0x232B:6 is stored. • 2500 + offset. The offset results from the data types of the previously mapped parameters.
0x232C:007 (PAR 531/007)	Modbus register assignment: Register 7 (Reg. assigned: Register 7) • Read only	Display of the internal Modbus register number starting from which the parameter mapped in 0x232B:7 is stored. • 2500 + offset. The offset results from the data types of the previously mapped parameters.
0x232C:008 (PAR 531/008)	Modbus register assignment: Register 8 (Reg. assigned: Register 8) • Read only	Display of the internal Modbus register number starting from which the parameter mapped in 0x232B:8 is stored. • 2500 + offset. The offset results from the data types of the previously mapped parameters.
0x232C:009 (PAR 531/009)	Modbus register assignment: Register 9 (Reg. assigned: Register 9) • Read only	Display of the internal Modbus register number starting from which the parameter mapped in 0x232B:9 is stored. • 2500 + offset. The offset results from the data types of the previously mapped parameters.
0x232C:010 (PAR 531/010)	Modbus register assignment: Register 10 (Reg. assigned: Register 10) • Read only	Display of the internal Modbus register number starting from which the parameter mapped in 0x232B:10 is stored. • 2500 + offset. The offset results from the data types of the previously mapped parameters.
0x232C:011 (PAR 531/011)	Modbus register assignment: Register 11 (Reg. assigned: Register 11) • Read only	Display of the internal Modbus register number starting from which the parameter mapped in 0x232B:11 is stored. • 2500 + offset. The offset results from the data types of the previously mapped parameters.
0x232C:012 (PAR 531/012)	Modbus register assignment: Register 12 (Reg. assigned: Register 12) • Read only	Display of the internal Modbus register number starting from which the parameter mapped in 0x232B:12 is stored. • 2500 + offset. The offset results from the data types of the previously mapped parameters.
0x232C:013 (PAR 531/013)	Modbus register assignment: Register 13 (Reg. assigned: Register 13) • Read only	Display of the internal Modbus register number starting from which the parameter mapped in 0x232B:13 is stored. • 2500 + offset. The offset results from the data types of the previously mapped parameters.



Configuring the network

Modbus Modbus data mapping

Parameter	Name / value range / [default setting]	Info
0x232C:014 (PAR 531/014)	Modbus register assignment: Register 14 (Reg. assigned: Register 14) • Read only	Display of the internal Modbus register number starting from which the parameter mapped in 0x232B:14 is stored. • 2500 + offset. The offset results from the data types of the previously mapped parameters.
0x232C:015 (PAR 531/015)	Modbus register assignment: Register 15 (Reg. assigned: Register 15) • Read only	Display of the internal Modbus register number starting from which the parameter mapped in 0x232B:15 is stored. • 2500 + offset. The offset results from the data types of the previously mapped parameters.
0x232C:016 (PAR 531/016)	Modbus register assignment: Register 16 (Reg. assigned: Register 16) • Read only	Display of the internal Modbus register number starting from which the parameter mapped in 0x232B:16 is stored. • 2500 + offset. The offset results from the data types of the previously mapped parameters.
0x232C:017 (PAR 531/017)	Modbus register assignment: Register 17 (Reg. assigned: Register 17) • Read only	Display of the internal Modbus register number starting from which the parameter mapped in 0x232B:17 is stored. • 2500 + offset. The offset results from the data types of the previously mapped parameters.
0x232C:018 (PAR 531/018)	Modbus register assignment: Register 18 (Reg. assigned: Register 18) • Read only	Display of the internal Modbus register number starting from which the parameter mapped in 0x232B:18 is stored. • 2500 + offset. The offset results from the data types of the previously mapped parameters.
0x232C:019 (PAR 531/019)	Modbus register assignment: Register 19 (Reg. assigned: Register 19) • Read only	Display of the internal Modbus register number starting from which the parameter mapped in 0x232B:19 is stored. • 2500 + offset. The offset results from the data types of the previously mapped parameters.
0x232C:020 (PAR 531/020)	Modbus register assignment: Register 20 (Reg. assigned: Register 20) • Read only	Display of the internal Modbus register number starting from which the parameter mapped in 0x232B:20 is stored. • 2500 + offset. The offset results from the data types of the previously mapped parameters.
0x232C:021 (PAR 531/021)	Modbus register assignment: Register 21 (Reg. assigned: Register 21) • Read only	Display of the internal Modbus register number starting from which the parameter mapped in 0x232B:21 is stored. • 2500 + offset. The offset results from the data types of the previously mapped parameters.
0x232C:022 (PAR 531/022)	Modbus register assignment: Register 22 (Reg. assigned: Register 22) • Read only	Display of the internal Modbus register number starting from which the parameter mapped in 0x232B:22 is stored. • 2500 + offset. The offset results from the data types of the previously mapped parameters.
0x232C:023 (PAR 531/023)	Modbus register assignment: Register 23 (Reg. assigned: Register 23) • Read only	Display of the internal Modbus register number starting from which the parameter mapped in 0x232B:23 is stored. • 2500 + offset. The offset results from the data types of the previously mapped parameters.
0x232C:024 (PAR 531/024)	Modbus register assignment: Register 24 (Reg. assigned: Register 24) • Read only	Display of the internal Modbus register number starting from which the parameter mapped in 0x232B:24 is stored. • 2500 + offset. The offset results from the data types of the previously mapped parameters.
0x232D (PAR 532)	Modbus verification code (Verification code) • Read only	
0x6071	Target torque -3276.8 ... [0.0] ... 3276.7 %	Setpoint torque • 100 % ≙ Motor rated torque 0x6076 (PAR 325)

Configuring the network

Modbus
Modbus LED status displays





8.5.9 Modbus LED status displays

Information about the Modbus status can be obtained quickly via the "MOD-RUN" and "MOD-ERR" LED displays on the front of the inverter.

The meaning can be seen from the tables below.

Inverter not active on the Modbus bus (yet)

LED display	Meaning
 (MOD-ERR is lit permanently)	Internal error
 (MOD-RUN and MOD-ERR are flickering)	Automatic baud rate detection active.

Inverter active on the Modbus

The green "MOD-RUN" LED indicates the communication status:

LED display	Communication status
Off	No reception / no transmission
On	Reception / transmission active

The red "MOD-ERR" LED indicates an error:

LED display	Fault
Off	No fault
Blinking	Communication error

8.5.10 Reset Modbus interface

Parameter	Name / value range / [default setting]	Info
0x2320 (PAR 508)	Activate Modbus network (<i>Activ. netw. sett.</i>) 0 ... [0] ... 1	1 = activate network options.

8.5.11 Modbus response time

Parameter	Name / value range / [default setting]	Info
0x2321:004 (PAR 510/004)	Modbus settings: Minimum response time (<i>Modbus sett.: Min. resp. time</i>) 0 ... [0] ... 1000 ms	Minimum time delay between the reception of a valid message and the response of the drive.



8.5.12 Short setup of Modbus

In the following, the steps required for controlling the inverter via Modbus are described.

Parameterisation required

1. Activate network: `0x2631:037 (PAR 400/037) = "1: TRUE"`
2. Set network as default setpoint source: `0x2860:001 (PAR 201/001) = "5: Network"`
3. Set Modbus node address. ▶ [Modbus node address](#) 127
4. Set Modbus baud rate. ▶ [Modbus baud rate](#) 128
 - Default setting: automatic detection.
 - If the automatic baud rate detection function is activated, the first 5 ... 10 messages are lost after switch-on.
5. Set Modbus data format. ▶ [Modbus data format](#) 128
 - Default setting: automatic detection.
 - If the automatic data format detection function is activated, the first 5 ... 10 messages are lost after switch-on.



Digital input DI1 is assigned with the "Start enable" function by default and therefore must be set to HIGH level. ▶ [Controller enable, starting & stopping, reversal](#) 188

Starting/stopping the drive via Modbus

For starting/stopping the drive, Modbus register 42101 can be used.

- Modbus register 42101 is permanently assigned to the AC Drive control word `0x400B:001 (PAR 592/001)`.
- In the frame, the leading 4 is omitted in the addressing process. The numbering of the registers starts with 1; addressing, however starts with 0. Therefore the address 2100 (`0x0834`) is used in the frame when register 42101 is written.

Bits set in the AC Drive control word:

- Bit 0 ≡ forward operation
- Bit 5 ≡ network control
- Bit 6 ≡ network setpoint set

Example of an inverter with the node address 1:

Request frame by the master							
Slave address	Function code	Data				Checksum (CRC)	
		Register address		AC Drive control word			
0x01	0x06	0x08	0x34	0x00	0x61	0x0B	0x8C

If digital input DI1 ("Start enable") is set to HIGH level, the drive should start and the inverter should respond with the same frame as confirmation:

Response message from the inverter							
Slave address	Function code	Data				Checksum (CRC)	
		Register address		AC Drive control word			
0x01	0x06	0x08	0x34	0x00	0x61	0x0B	0x8C

Configuring the process controller

Modbus
Short setup of Modbus



9 Configuring the process controller



9.1 Basic process controller settings

By means of the process controller, a process variable can be regulated, for instance the pressure of a pump. The process controller is also referred to as "PID controller" (PID controller = proportional, integral and differential controller).

Details

The process controller is part of a closed control loop. The variable to be influenced (controlled variable) is measured continuously by means of a sensor and supplied to the inverter as an analog signal (actual value) which, in the inverter, is then compared to the reference value (setpoint). The system deviation resulting therefrom is supplied to the process controller which, on this basis, decelerates or accelerates the motor speed according to the desired dynamic performance of the control loop, so that, for instance, a pump always generates the desired pressure.

The basic setting of the process controller is carried out via the following parameters.

Parameter	Name / value range / [default setting]	Info
0x4020:001 (PAR 600/001)	Process controller: Operating mode (Process controller: Operating mode)	Selection of the process controller operating mode.
	0 Inhibited	Process controller deactivated.
	1 Normal operation	If the controlled variable (actual value) fed back is reduced, the motor speed is increased. Example: pressure-controlled booster pumps (increase in the motor speed produces an increase in pressure.)
	2 Reversing duty	If the controlled variable (actual value) fed back is reduced, the motor speed is also reduced. Example: temperature-controlled cooling water pump (increase in motor speed produces decrease in temperature.)
	3 Normal operation in both rotating directions	As selection 1, but also inverted rotating direction possible if both rotating directions are enabled with the setting 0x283A (PAR 304) = 1.
4 Reversing duty in both rotating directions	As selection 2, but also inverted rotating direction possible if both rotating directions are enabled with the setting 0x283A (PAR 304) = 1.	
0x4020:002 (PAR 600/002)	Process controller: Feedback source (Process controller: PID feedback)	Selection of the source via which the feedback of the controlled variable (actual value) for the process controller is effected.
	1 Analog input 1	
2 Analog input 2		
0x4020:003 (PAR 600/003)	Process controller: Closed-loop controlled speed range (Process controller: PID speed range) 0 ... [100] ... 100 %	Setting of the maximum output frequency up to which the process controller carries out regulation. <ul style="list-style-type: none"> 100 % ≙ upper frequency limit value 0x2916 (PAR 211).
0x4020:004 (PAR 600/004)	Process controller: Speed feedforward control source (Process controller: PID line speed)	Optional selection of a speed feedforward control source for the process controller. <ul style="list-style-type: none"> Is advisable, for instance, for dancer position controls if the motor speed must not fall below line speed (process controller output value = line speed + controlled motor speed). Standard applications usually do not require a speed feedforward control; therefore it is deactivated in the default setting.
	0 Without speed feedforward control	
	1 Keypad frequency setpoint	
	2 Analog input 1	
	3 Analog input 2	
	4 Preset frequency setpoint 1	
	5 Preset frequency setpoint 2	
	6 Preset frequency setpoint 3	
	7 Preset frequency setpoint 4	
8 Network		
0x4021:001 (PAR 606/001)	Process controller speed operation: Acceleration time (PID acc./dec.: PID acceleration time) 0.0 ... [1.0] ... 3600.0 s	Acceleration time for (temporary) speed-controlled drive control in process controller mode. <ul style="list-style-type: none"> This acceleration time is effective if process controller mode is active and a change-over to speed-controlled operation has been effected by the trigger set in 0x2631:045 (PAR 400/045). The acceleration time takes effect at the output of the process controller.

Configuring the process controller

Basic process controller settings



Parameter	Name / value range / [default setting]	Info
0x4021:002 (PAR 606/002)	Process controller speed operation: Deceleration time (PID acc./dec.: PID deceleration time) 0.0 ... [1.0] ... 3600.0 s	Deceleration time for (temporary) speed-controlled drive control in process controller mode. <ul style="list-style-type: none"> This deceleration time is effective if process controller mode is active and a change-over to speed-controlled operation has been effected by the trigger set in 0x2631:045 (PAR 400/045). The deceleration time takes effect at the output of the process controller.
0x4048 (PAR 601)	P component gain (P-gain) 0.0 ... [5.0] ... 1000.0 %	Output frequency of the process controller per 1 % system deviation. <ul style="list-style-type: none"> 100 % ≙ maximum frequency 0x2916 (PAR 211).
0x4049 (PAR 602)	I component reset time (I-deceleration) 20 ... [400] ... 6000 ms	Reset time for system deviation. <ul style="list-style-type: none"> With the setting "6000 ms", the I component is deactivated. The I component can also be deactivated via a trigger assigned in 0x2631:047 (PAR 400/047) of the "Inhibit process controller I-component" 0x2631:047 (PAR 400/047) function.
0x404A (PAR 603)	D component gain (D-gain) 0.0 ... [0.0] ... 20.0 s	D component, does not respond to the rate of the system deviation, but only to its rate of change.
0x404B (PAR 604)	Setpoint ramp (process controller) (PID setp.ramp) 0.0 ... [20.0] ... 100.0 s	Acceleration time and deceleration time for the process controller setpoint, relating to the entire setting range of the process controller.
0x404C:001 (PAR 607/001)	Process controller influence: Acceleration time for showing (PID influence: Show time) 0.0 ... [5.0] ... 999.9 s	If the trigger assigned in 0x2631:048 (PAR 400/048) of the "Activate process controller influence ramp" function is TRUE, the influence of the process controller is shown by means of a ramp with the acceleration time set here.
0x404C:002 (PAR 607/002)	Process controller influence: Deceleration time for masking out (PID influence: Mask out time) 0.0 ... [5.0] ... 999.9 s	If the trigger assigned in 0x2631:048 (PAR 400/048) of the "Activate process controller influence ramp" function is FALSE, the influence of the process controller is hidden via a ramp with the deceleration time set here.
0x404D:001 (PAR 608/001)	Process controller alarms: MIN alarm threshold (PID alarms: PID min alarm) -300.00 ... [0.00] ... 300.00 PUnit	Trigger threshold for the "MIN alarm" trigger. <ul style="list-style-type: none"> The "MIN alarm" trigger is TRUE if the controlled variable fed back (in process controller mode) is smaller than the threshold set here. The trigger can be assigned to the relay, a digital output, or the NET-WordOUT1 status word. ▶ Configuration of digital outputs □ 215
0x404D:002 (PAR 608/002)	Process controller alarms: MAX alarm threshold (PID alarms: PID max alarm) -300.00 ... [100.00] ... 300.00 PUnit	Trigger threshold for the "MAX alarm" trigger. <ul style="list-style-type: none"> The "MAX alarm" trigger is TRUE if the controlled variable fed back (in process controller mode) is greater than the threshold set here. The trigger can be assigned to the relay, a digital output or the NET-WordOUT1 status word. ▶ Configuration of digital outputs □ 215
0x404E:001 (PAR 605/001)	Setpoint limits (process controller): Minimum setpoint (PID setp. limit: PID setp. min.) -300.00 ... [-300.00] ... 300.00 PUnit	Minimum value of the process controller setting range.
0x404E:002 (PAR 605/002)	Setpoint limits (process controller): Maximum setpoint (PID setp. limit: PID setp. max.) -300.00 ... [300.00] ... 300.00 PUnit	Maximum value of the process controller setting range.
0x2860:002 (PAR 201/002)	Standard setpoint sources: Process controller setpoint source (Standard setpoint: PID setpoint) <ul style="list-style-type: none"> For possible settings see description for 0x2860:002 (PAR 201/002). □ 70 	Selection of the standard setpoint source for process controller mode. <ul style="list-style-type: none"> The standard setpoint source is always active in process controller mode if no setpoint change-over to another setpoint source via corresponding triggers/functions is active.
	1 Keypad	The setpoint is specified locally by the keypad. <ul style="list-style-type: none"> Default setting: 0x2601:002 (PAR 202/002) Use the ↑ and ↓ navigation keys to change the keypad setpoint (also during running operation).



Configuring the process controller

Basic process controller settings

Parameter	Name / value range / [default setting]	Info
0x401F:003 (PAR 121/003)	Process controller diagnostics: Status (PID diagnostics: PID status)	Bit-coded status display of the process controller.
	• Read only	
	Bit 0 Process controller off	
	Bit 1 Process controller output set to 0	
	Bit 2 Process controller I-component set to 0	
	Bit 3 Process controller influence is shown via ramp	
	Bit 4 Setpoint = actual value	
	Bit 5 Idle state active	
Bit 6 Reserved		
Bit 7		

Configuring the process controller

Process controller - idle state and rinse function
Process controller idle state



9.2 Process controller - idle state and rinse function

9.2.1 Process controller idle state

This function sets the drive in process controller mode to an energy-saving idle state when no power is required.

Parameter	Name / value range / [default setting]	Info
0x4023:001 (PAR 610/001)	Process controller idle state: Activation (Sleep mode sett.: Sleep start mode)	Selection of the condition for activating the idle state.
	0 Inhibited	Idle state deactivated.
	1 Setpoint < threshold	Activation of idle state if frequency setpoint < frequency threshold 0x4023:003 (PAR 610/003) longer than the deceleration time 0x4023:005 (PAR 610/005).
	2 Setpoint < threshold OR feedback > feedback threshold	Activation of idle state if <ul style="list-style-type: none"> frequency setpoint < frequency threshold 0x4023:003 (PAR 610/003) longer than the deceleration time 0x4023:005 (PAR 610/005) OR controlled variable fed back > feedback threshold 0x4023:004 (PAR 610/004) longer than the deceleration time 0x4023:005 (PAR 610/005).
3 Setpoint < threshold OR feedback < feedback threshold	Activation of idle state if <ul style="list-style-type: none"> frequency setpoint < frequency threshold 0x4023:003 (PAR 610/003) longer than the deceleration time 0x4023:005 (PAR 610/005) OR controlled variable fed back < feedback threshold 0x4023:004 (PAR 610/004) longer than the deceleration time 0x4023:005 (PAR 610/005). 	
0x4023:002 (PAR 610/002)	Process controller idle state: Stop method (Sleep mode sett.: Sleep stop meth.)	Selection of the stop method after activation of the idle state.
	0 Coasting	The motor coasts down to standstill.
	1 Deceleration to standstill	The motor is brought to a standstill with deceleration time 1 (or deceleration time 2, if activated). <ul style="list-style-type: none"> Deceleration time 1 can be set in 0x2918 (PAR 221). Deceleration time 2 can be set in 0x291A (PAR 223). ▶ Frequency limits and ramp times □ 73
2 Stop method set	The stop method set in 0x2838:003 (PAR 203/003) is used.	
0x4023:003 (PAR 610/003)	Process controller idle state: Frequency threshold (Sleep mode sett.: Sleep freq. thresh.) 0.0 ... [0.0] ... 599.0 Hz	Frequency threshold for the activation of the idle state.
0x4023:004 (PAR 610/004)	Process controller idle state: Feedback threshold (Sleep mode sett.: Sleep fdbk thresh.) -300.00 ... [0.00] ... 300.00 PUnit	Feedback threshold for the activation of the idle state.
0x4023:005 (PAR 610/005)	Process controller idle state: Deceleration time (Sleep mode sett.: Sleep dec.) 0.0 ... [0.0] ... 300.0 s	Minimum time for which the respective threshold must be underrun or exceeded before the idle state is activated.
0x4023:006 (PAR 610/006)	Process controller idle state: Completion (Sleep mode sett.: Sleep rec. mode)	Selection of the condition for terminating the idle state.
	0 Setpoint > threshold OR system deviation > bandwidth	Completion of idle state if <ul style="list-style-type: none"> frequency setpoint > (frequency threshold 0x4023:003 (PAR 610/003) + 2 Hz hysteresis) OR system deviation > bandwidth 0x4023:007 (PAR 610/007) in the process controller mode.
	1 Feedback < completion threshold	Completion of idle state if the controlled variable fed back < completion threshold 0x4023:008 (PAR 610/008).
2 Feedback > completion threshold	Completion of idle state if the controlled variable fed back > completion threshold 0x4023:008 (PAR 610/008).	
0x4023:007 (PAR 610/007)	Process controller idle state: Bandwidth (Sleep mode sett.: Sleep bandw.) 0.00 ... [0.00] ... 300.00 PUnit	Range around the process controller setpoint for terminating the idle state.
0x4023:008 (PAR 610/008)	Process controller idle state: Completion threshold (Sleep mode sett.: Sleep fdbck.rec) -300.00 ... [0.00] ... 300.00 PUnit	Termination threshold for idle state.



Configuring the process controller

Process controller - idle state and rinse function
 Process controller rinse function

9.2.2 Process controller rinse function

This function accelerates the drive in sleep mode to a defined speed at regular intervals. The rinsing of a pump that has been in an inactive state for a longer period is a typical application.

Parameter	Name / value range / [default setting]	Info
0x4024:001 (PAR 615/001)	Automatic rinsing: Rinsing in idle state (Set auto-rinse: Auto-rinse mode)	1 = activate automatic rinsing in idle state.
	0 Inhibited	
	1 Enabled	
0x4024:002 (PAR 615/002)	Automatic rinsing: Time period between rinsing processes (Set auto-rinse: Auto-rinse del.) 0.0 ... [30.0] ... 6000.0 min	Time interval between two rinsing processes.
0x4024:003 (PAR 615/003)	Automatic rinsing: Speed (Set auto-rinse: Auto-rinse speed) -599.0 ... [0.0] ... 599.0 Hz	Speed setpoint for rinse function.
0x4024:004 (PAR 615/004)	Automatic rinsing: Duration of rinsing process (Set auto-rinse: Auto-rinse time) 0.0 ... [0.0] ... 6000.0 s	Duration of a rinsing process.

Additional functions

Process controller - idle state and rinse function
Process controller rinse function



10 Additional functions

- [Device Commands](#) 145
- [Keypad](#) 151
- [DC braking](#) 153
- [Brake energy management](#) 155
- [Load loss detection](#) 158
- [Access protection](#) 159
- [Favorites](#) 162
- [Parameter change-over](#) 167
- [Device profile CiA402](#) 177
- [Holding brake control](#) 180
- [Flying restart function](#) 182
- [Fault configuration](#) 183
- [Parameter for engineering tools](#) 184



10.1 Device Commands

10.1.1 Restoring the Lenze settings

With the "Load Lenze settings" device command, all parameters can be reset to the Lenze setting.



By executing this device command, all parameter settings made by the user are lost!

Details

- All parameters in the RAM memory of the inverter are set to the Lenze setting stored in the firmware of the inverter. (The persistent parameters in the memory module remain unaffected by this measure.)
- Afterwards the inverter can be parameterised again on the basis of this initial state.
- Typical application: incorrect or unknown parameter settings.

Parameter	Name / value range / [default setting]	Info
0x2022:001 (PAR 700/001)	Device commands: Load Lenze settings (Device commands: Load Lenze sett.) • Setting can only be changed if controller inhibit is active.	1 ≙ reset all parameters in the RAM memory of the inverter to the Lenze setting that is stored in the inverter firmware. • All parameter changes made by the user are lost during this process! • It may take some seconds to execute the task. When the task has been executed successfully, the value 0 is shown.
	0 Off / ready	Only status feedback.
	1 On / start	Execute device command.
	2 In progress	Only status feedback.
	3 Action cancelled	
	4 No access	
	5 No access (controller inhibit)	

Additional functions

Device Commands
Saving/loading the parameter settings



10.1.2 Saving/loading the parameter settings

If parameter settings of the inverter are changed, these changes at first are only made in the RAM memory of the inverter. In order to save the parameter settings with mains failure protection, the inverter is provided with a pluggable memory module and corresponding device commands.

Details

The memory module is provided with two memories, the user memory and the OEM memory.

- The keypad can be used to save changed parameter settings in the user memory by clicking the keypad Enter key > 3 s.
- Parameter settings carried out with »EASY Starter« or via network must be explicitly saved in the user memory by means of the "Save data in the user memory" device command, so that the changes carried out are not lost when the mains of the inverter are switched.

OEM memory

The OEM memory is provided for the storage of customised parameter settings by the OEM/mechanical engineer. If the user carries out parameter settings with the keypad, they are always saved in the user memory if the keypad Enter key is clicked > 3 s. The OEM memory remains unaffected by these changes.

- With the "Load data from the OEM memory" device command, the parameter settings pre-configured by the OEM/mechanical engineer can be reloaded to the RAM memory of the inverter anytime, if required.
- Parameter settings can only be stored in the OEM memory with »EASY Starter« or via network. This explicitly requires execution of the "Save data in the OEM memory" device command. At the same time, the parameter settings are stored in the user memory.

Response after initial switch-on of the inverter

After switch-on, the inverter first tries to load the parameter settings stored in the user memory. If the user memory is empty or damaged, an error message is output and the user must intervene:

- Option 1 = user memory empty: → Lenze setting is loaded automatically → data are saved automatically in the user memory of the memory module.
- Option 2 = user memory damaged: → error message → Lenze setting is loaded manually → data are saved manually in the user memory of the memory module.
- Option 3 = OEM memory empty/damaged: → error message → data are loaded manually from the user memory of the memory module.

Parameter	Name / value range / [default setting]	Info
0x2022:003 (PAR 700/003)	Device commands: Save data in the user memory (Device commands: Save user data)	1 = save current parameter settings in the main memory of the memory module with mains failure protection. <ul style="list-style-type: none"> • It may take some seconds to execute the task. When the task has been executed successfully, the value 0 is shown. • Do not switch off the supply voltage during the saving process and do not unplug the memory module from the inverter! • When the inverter is switched on, all parameters are automatically loaded from the main memory of the memory module to the RAM memory of the inverter.
	0 Off / ready	Only status feedback.
	1 On / start	Execute device command.
	2 In progress	Only status feedback.
	3 Action cancelled	
	4 No access	
	5 No access (controller inhibit)	



Additional functions

Device Commands

Saving/loading the parameter settings

Parameter	Name / value range / [default setting]	Info
0x2022:004 (PAR 700/004)	Device commands: Load data from the user memory (<i>Device commands: Load user data</i>) <ul style="list-style-type: none"> Setting can only be changed if controller inhibit is active. 	1 = load data from the main memory of the memory module to the RAM memory of the inverter. <ul style="list-style-type: none"> After successful execution, the value 0 is shown.
	0 Off / ready	Only status feedback.
	1 On / start	Execute device command.
	2 In progress	Only status feedback.
	3 Action cancelled	
	4 No access	
5 No access (controller inhibit)		
0x2022:005 (PAR 700/005)	Device commands: Load data from the OEM memory (<i>Device commands: Load OEM data</i>) <ul style="list-style-type: none"> Setting can only be changed if controller inhibit is active. 	1 = load data from the OEM memory of the memory module to the RAM memory of the inverter. <ul style="list-style-type: none"> After successful execution, the value 0 is shown.
	0 Off / ready	Only status feedback.
	1 On / start	Execute device command.
	2 In progress	Only status feedback.
	3 Action cancelled	
	4 No access	
5 No access (controller inhibit)		
0x2022:006 (PAR 700/006)	Device commands: Save data in the OEM memory (<i>Device commands: Save OEM data</i>)	1 = save current parameter settings in the OEM memory of the memory module with mains failure protection. <ul style="list-style-type: none"> At the same time, the parameter settings are saved in the main memory of the memory module. After successful execution, the value 0 is shown.
	0 Off / ready	Only status feedback.
	1 On / start	Execute device command.
	2 In progress	Only status feedback.
	3 Action cancelled	
	4 No access	
5 No access (controller inhibit)		
0x2829 (PAR 732)	Automatic storage in the memory module (<i>Autom. EPM data</i>)	1 = activate automatic saving of parameters in the memory module. <ul style="list-style-type: none"> With the setting 0, the "Save data in the user memory" 0x2022:003 (PAR 700/003) device command must be explicitly executed, or the "Enter" keypad key must be pressed for longer than 3 s to save the current parameter settings in the memory module of the inverter with mains failure protection.
	0 Inhibit	
	1 Enable	

Additional functions

Device Commands
Device commands for parameter change-over



10.1.3 Device commands for parameter change-over

Irrespective of the state of the functions/triggers for this function, the "Parameter change-over" function can also be optionally executed with the device commands specified here.

DANGER!

Changed parameter settings can become effective immediately depending on the activating method set in [0x4046 \(PAR 755\)](#).

The possible consequence is an unexpected response of the motor shaft while the inverter is enabled.

- ▶ If possible, only carry out parameter changes while the controller is inhibited.
- ▶ Certain device commands or settings which could cause a critical state of the drive behaviour can generally only be carried out with controller inhibit.

Details

If activation method 1 or 3 is set in [0x4046 \(PAR 755\)](#), the change-over is effected immediately. If activation method 0 or 2 is set, the respective device command is only executed if the inverter is inhibited.

Detailed information about the "Parameter change-over" function can be found in the "[Parameter change-over](#)" chapter. [167](#)

Parameter	Name / value range / [default setting]	Info
0x2022:007 (PAR 700/007)	Device commands: Load parameter set 1 (Device commands: Load par. set 1)	1 = load value set 1 of the "Parameter change-over" function. • The parameters specified in 0x4041/1...32 are set to the values set in 0x4042/1...32. • After successful execution, the value 0 is shown. ▶ Parameter change-over 167
	0 Off / ready	Only status feedback.
	1 On / start	Execute device command.
	2 In progress	Only status feedback.
	3 Action cancelled	
	4 No access	
5 No access (controller inhibit)		
0x2022:008 (PAR 700/008)	Device commands: Load parameter set 2 (Device commands: Load par. set 2)	1 = load value set 2 of the "Parameter change-over" function. • The parameters specified in 0x4041/1...32 are set to the values set in 0x4043/1...32. • After successful execution, the value 0 is shown. ▶ Parameter change-over 167
	0 Off / ready	Only status feedback.
	1 On / start	Execute device command.
	2 In progress	Only status feedback.
	3 Action cancelled	
	4 No access	
5 No access (controller inhibit)		
0x2022:009 (PAR 700/009)	Device commands: Load parameter set 3 (Device commands: Load par. set 3)	1 = load value set 3 of the "Parameter change-over" function. • The parameters specified in 0x4041/1...32 are set to the values set in 0x4044/1...32. • After successful execution, the value 0 is shown. ▶ Parameter change-over 167
	0 Off / ready	Only status feedback.
	1 On / start	Execute device command.
	2 In progress	Only status feedback.
	3 Action cancelled	
	4 No access	
5 No access (controller inhibit)		



Additional functions

Device Commands
Initialising the network interface

Parameter	Name / value range / [default setting]	Info
0x2022:010 (PAR 700/010)	Device commands: Load parameter set 4 (Device commands: Load par. set 4)	1 = load value set 4 of the "Parameter change-over" function. <ul style="list-style-type: none"> The parameters specified in 0x4041/1...32 are set to the values set in 0x4045/1...32. After successful execution, the value 0 is shown. ▶ Parameter change-over 167
	0 Off / ready	Only status feedback.
	1 On / start	Execute device command.
	2 In progress	Only status feedback.
	3 Action cancelled	
	4 No access	
	5 No access (controller inhibit)	

10.1.4 Initialising the network interface

Changed communication settings (e.g. baud rate or node address) only become effective when the network interface has been initialised. This either requires switching the inverter off and on again or executing the "Reset network node" device command.

Parameter	Name / value range / [default setting]	Info
0x2022:016 (PAR 700/016)	Device commands: Reset network node (Device commands: Reset netw. node) 0 ... [0] ... 1 • Setting can only be changed if controller inhibit is active.	1 = initialise network interface. <ul style="list-style-type: none"> Required when the baud rate, node address, or identifiers are changed. After successful execution, the value 0 is shown.
0x2022:027 (PAR 700/027)	Device commands: Accept new inverter hardware (Device commands: Accept new HW) 0 ... [0] ... 1 • Setting can only be changed if controller inhibit is active.	1 = initialise parameters for a new network option.

10.1.5 Updating the memory module data format

If the memory module contains valid parameter data of a previous firmware version they can be converted to a format matching the current firmware version of the inverter by means of the "Updating the memory module data format" device command.



When this device command has been executed, the data in the memory module are no longer compatible with previous firmware versions!

Details

- The inverter also works with parameter settings of a previous firmware version. However, it is only possible to make changes to the parameter settings if the parameter settings in the memory module match the firmware version of the inverter.
- The keypad shows the "PS02 error" message if the parameter data in the memory module deviate from the firmware version of the inverter.

Parameter	Name / value range / [default setting]	Info
0x2022:026 (PAR 700/026)	Device commands: Updating the memory module data format (Device commands: Compile EPM) 0 ... [0] ... 1 • Setting can only be changed if controller inhibit is active.	1 = convert parameter data in the memory module to a format matching the current firmware version of the inverter.

Additional functions

Device Commands
Delete logbook



10.1.6 Delete logbook

By means of the "Delete logbook" device command, all logbook entries can be deleted.

Parameter	Name / value range / [default setting]	Info
0x2022:015 (PAR 700/015)	Device commands: Delete logbook (Device commands: Delete logbook) 0 ... [0] ... 1 • Setting can only be changed if controller inhibit is active.	1 = delete all entries in the logbook.



10.2 Keypad

For the keypad various settings can be made, which are described in detail in the following subchapters.

10.2.1 Keypad language Selection

Parameter	Name / value range / [default setting]	Info
0x2863 (PAR 705)	Keypad language selection (Language selection)	Language selection for the keypad display.
	0 No language selected	
	1 English	
	2 German	

10.2.2 Keypad setpoint increment

Parameter	Name / value range / [default setting]	Info
0x2862 (PAR 701)	Keypad setpoint increment (Keypad setpoint) 1 ... [1] ... 100	Adaptation of the increment for keypad setpoints when a keypad arrow key is pressed once. The value set serves as a multiplier for the preset increments. Preset increments: <ul style="list-style-type: none"> • 0.1 Hz for frequency setpoint 0x2601:001 (PAR 202/001). • 0.01 PUnit for process controller setpoint 0x2601:002 (PAR 202/002). • 1 % for torque setpoint . Notes: <ul style="list-style-type: none"> • With a setting > 1, the option of repeatedly changing the setpoint by pressing the key for a longer time is deactivated. • The setting only has an impact on the keypad setpoints. Example: with the setting "5", the keypad frequency setpoint is increased/decreased by 0.5 Hz every time the key is pressed.

10.2.3 Keypad scaling of speed display

Parameter	Name / value range / [default setting]	Info
0x4002 (PAR 702)	Speed display scaling (Scaled speed factor) 0.00 ... [0.00] ... 650.00	Factor for the scaling of the speed display in 0x400D (PAR 101) . <ul style="list-style-type: none"> • With the setting "0.00", no scaling takes place. • Example: with the "16.50" and the actual frequency = 50 Hz, 0x400D (PAR 101) shows the speed "825 rpm".
0x400D (PAR 101)	Scaled actual value (Scaled actual value) <ul style="list-style-type: none"> • Read only: x Units 	Display of the current speed in application units.

Additional functions

Keypad
Keypad status display



10.2.4 Keypad status display

During operation, the keypad displays the output frequency of the inverter, and in process controller mode it shows the process controller setpoint. Alternatively, an optional diagnostic parameter can be displayed during operation.

Details

Normal display depending on the operating mode

- In the default speed mode, the keypad displays the output frequency of the inverter.
- If process controller mode is enabled and active, the keypad shows the current process controller setpoint in [P unit]. If process controller mode is not active, the keypad displays the output frequency of the inverter again.
- If the inverter is working in torque mode, the keypad displays the output frequency of the inverter.

Alternative display during operation

- In [0x2864 \(PAR 703\)](#), an optional diagnostic parameter can be set, which is to be shown on the keypad during operation.
- In order to activate the normal display again, [0x2864 \(PAR 703\)](#) = 0 is to be set.

Parameter	Name / value range / [default setting]	Info
0x2864 (PAR 703)	Keypad status display (KP running indicator) 0x00000000 ... [0x00000000] ... 0xFFFFFFFF00	0 = normal display depending on the operating mode. As an alternative, an optional diagnostic parameter can be set here, which is to be shown on the keypad during operation. <ul style="list-style-type: none">• Format: 0xiiii:ss00 (iiii = hexadecimal index, ss = hexadecimal subindex)• The lowest byte is always 0x00.• Keypad format: Piii.ss (iii = decimal PAR number, ss = decimal subindex)



10.3 DC braking

The "DC braking" function allows the drive to be quickly braked to a standstill without the need of using an external brake resistor.

i NOTICE!

Avoid long-time activation of the "DC braking" function with a high braking current or a high braking voltage!

Possible consequence: thermal motor overload.

- ▶ Only use the "DC braking" function in applications in which the load is only exceptionally stopped.

Details

The function can be used as follows:

1. Automatically at motor start-up:

- DC braking can be selected as starting method in [0x2838:001 \(PAR 203/001\)](#).
- At motor start-up, DC braking is then active with the braking current set in [0x2B84:001 \(PAR 704/001\)](#) for the hold time set in [0x2B84:002 \(PAR 704/002\)](#).
- Only when the hold time has elapsed, the motor is accelerated to the setpoint.

2. Automatically when the motor is stopped:

- If the motor frequency falls below the operating threshold set in [0x2B84:003 \(PAR 704/003\)](#) when the motor is stopped, the inverter stops the deceleration process.
- DC braking then becomes active with the braking current set in [0x2B84:001 \(PAR 704/001\)](#) for the hold time set in [0x2B84:002 \(PAR 704/002\)](#).

3. Manually:

- DC braking can be activated manually via the trigger assigned to the "DC braking" function. ▶ [Activating DC braking manually](#) □ 202
- DC braking then remains active as long as the trigger is TRUE.

Parameter	Name / value range / [default setting]	Info
0x2B84:001 (PAR 704/001)	DC braking: Current (DC braking: Current) 0.0 ... [0.0] ... 200.0 %	Braking current for DC braking. • 100 % ≙ rated motor current 0x6075 (PAR 323)
0x2B84:002 (PAR 704/002)	DC braking: Automatic hold time (DC braking: Hold time autom.) 0.0 ... [0.0] ... 999.9 s	Hold time for automatic DC braking. • The "Automatic DC braking" function is active for the time set here.
0x2B84:003 (PAR 704/003)	DC braking: Automatic operating threshold (DC braking: Threshold autom.) 0.0 ... [0.0] ... 599.0 Hz	Operating threshold for automatic DC braking. • With the setting 0, the "Automatic DC braking" function is deactivated.
0x2631:005 (PAR 400/005)	Function assignment: DC braking (Function list: DC braking) • For possible settings see description for 0x2631:001 (PAR 400/001) . □ 188	Assignment of a trigger for the "DC braking" function. Trigger = TRUE: "DC braking" function is activated. Trigger = FALSE: no action / deactivate function again. ▶ DC braking □ 153
	00 Not connected	No trigger assigned (trigger is constantly FALSE).

Additional functions

DC braking



Parameter	Name / value range / [default setting]	Info
0x2838:001 (PAR 203/001)	Start/stop configuration: Start method (Start/stop cfg: Start method) <ul style="list-style-type: none"> Setting can only be changed if controller inhibit is active. 	Starting performance of the inverter.
	0 Normal	After switch-on, the standard ramps are active. <ul style="list-style-type: none"> Acceleration time 1 can be set in 0x2917 (PAR 220). Deceleration time 1 can be set in 0x2918 (PAR 221).
	1 Start with DC braking	After switch-on, the "DC braking" function is active for the time set in 0x2B84:002 (PAR 704/002) . ▶ DC braking ☐ 153
	2 Flying Start	After switch-on, the "Restart on the fly" function is active. This function makes it possible to restart a coasting motor on the fly during operation without speed feedback. Synchronicity between the inverter and the motor is coordinated so that the transition to the rotating drive is effected without jerk at the time of connection. ▶ Flying restart function ☐ 182
0x2838:003 (PAR 203/003)	Start/stop configuration: Stop method (Start/stop cfg: Stop method)	Behaviour after the "Stop" command.
	0 Coasting	The motor coasts down to standstill.
	1 Standard Ramp	The motor is brought to a standstill with deceleration time 1 (or deceleration time 2, if activated). <ul style="list-style-type: none"> Deceleration time 1 can be set in 0x2918 (PAR 221). Deceleration time 2 can be set in 0x291A (PAR 223). ▶ Frequency limits and ramp times ☐ 73
	2 Quick stop ramp	The motor is brought to a standstill with the deceleration time set for the "Quick stop" function. <ul style="list-style-type: none"> Deceleration time for quick stop can be set in 0x291C (PAR 225).



10.4 Brake energy management

When braking electrical motors, the kinetic energy of the drive train is fed back regeneratively to the DC bus. This energy causes a DC-bus voltage boost. If the energy fed back is too high, the inverter reports an error.

Several different strategies can serve to avoid DC-bus overvoltage:

- Use of a brake resistor
- Stopping the deceleration ramp function generator when the brake chopper threshold is exceeded
- Use of the "Inverter motor brake" function
- Combination of the above named options
- DC-bus connection

Details

The voltage threshold for braking operation results on the basis of the rated mains voltage set:

Rated mains voltage	Voltage threshold for braking operation
230 V	DC 380 V
400 V	DC 725 V
480 V	DC 775 V

The voltage threshold for braking operation can be reduced by 0 ... 100 V. The reduction required can be set in [0x2541:003 \(PAR 706/003\)](#).

If the DC-bus voltage exceeds the voltage threshold for braking operation, the braking method selected in [0x2541:001 \(PAR 706/001\)](#) is applied.

- Optimum following of the actual frequency value to the frequency setpoint (e.g. quick stop of the motor) can always be achieved by the use of a brake resistor.
- Stopping the ramp function generator enables smoother deceleration with lower torque oscillation..
- The "Inverter motor brake" function allows for quick braking without using a brake resistor. For process-related reasons, torque oscillations may occur.

Parameter	Name / value range / [default setting]	Info
0x2541:001 (PAR 706/001)	Brake energy management: Operating mode (<i>Brake management: Operating mode</i>)	Selection of the braking method. <ul style="list-style-type: none"> • The braking method(s) selected is/are activated if the DC-bus voltage exceeds the voltage threshold for the braking operation shown in 0x2541:002 (PAR 706/002).
	0 Brake resistor	The integrated brake chopper (brake transistor) is used.
	1 Deceleration ramp function generator stop	The deceleration ramp function generator is stopped. ▶ Stopping the deceleration ramp function generator ¶ 156
	2 Brake resistor and deceleration ramp function generator stop	The brake resistor is supplied with current and the deceleration ramp function generator is stopped.
	3 Inverter motor brake and deceleration ramp function generator stop	Braking with the "Inverter motor brake" braking method in connection with "Deceleration ramp function generator stop" is executed. ▶ Inverter motor brake ¶ 157
4 Brake resistor, inverter motor brake, and deceleration ramp function generator stop	Braking is performed by combining all three braking procedures.	
0x2541:002 (PAR 706/002)	Brake energy management: Active threshold (<i>Brake management: Active threshold</i>) <ul style="list-style-type: none"> • Read only: x V 	Display of the active voltage threshold for braking operation ("brake chopper threshold"). <ul style="list-style-type: none"> • The voltage threshold shown depends on the mains voltage selected in 0x2540:001 (PAR 208/001) and the voltage value set in 0x2541:003 (PAR 706/003). • The voltage threshold must not exceed the steady-state DC voltage establishing itself in the DC bus!
0x2541:003 (PAR 706/003)	Brake energy management: Reduced threshold (<i>Brake management: Red. threshold</i>) 0 ... [0] ... 100 V	The voltage threshold for braking operation ("brake chopper threshold") is reduced by the voltage value set here.

Additional functions

Brake energy management
Stopping the deceleration ramp function generator



Parameter	Name / value range / [default setting]	Info
0x2541:005 (PAR 706/005)	Brake energy management: Deceleration override time (<i>Brake management: Del. overr. time</i>) 0.0 ... [2.0] ... 60.0 s	Maximum permissible time for the deceleration override by means of the braking method selected in 0x2541:001 (PAR 706/001) . <ul style="list-style-type: none">• If the deceleration continues for a longer time, the "Overvoltage in the DC bus" error is tripped.• If the DC-bus voltage does not fall below the voltage threshold for braking operation shown in 0x2541:002 (PAR 706/002) within this time, the drive is decelerated further.• The time is only reset if the voltage threshold shown in 0x2541:002 (PAR 706/002) is not reached.
0x2540:001 (PAR 208/001)	Mains voltage: Rated mains voltage (<i>Mains volt. sett.: AC input volt.</i>) <ul style="list-style-type: none">• Setting can only be changed if controller inhibit is active.	Selection of the mains voltage for actuating the inverter.
	0 230 Veff	
	1 400 Veff	
	2 480 Veff	

10.4.1 Stopping the deceleration ramp function generator

The deceleration ramp function generator is stopped for a short time if the voltage threshold for braking operation is exceeded.

Details

This braking method does not feature any individual parameters.



10.4.2 Inverter motor brake

With this braking method, which can be selected in `0x2541:001 (PAR 706/001)`, the regenerative energy in the motor is converted as a result of dynamic acceleration/deceleration with down-ramping of the ramp function generator.

i NOTICE!

Too frequent braking may cause thermal overload of the motor.

- ▶ Avoid activating the "Inverter motor brake" function over a longer time!
- ▶ In applications with a high mass inertia and long braking times (> 2 s), use the "DC braking" function.

Preconditions

- The "Inverter motor brake" braking method must not be used with vertical conveyors (hoists) or with active loads!
- The "Inverter motor brake" braking method only works in operating mode `0x6060 (PAR 301)` = "-2: Lenze velocity mode".
- The motor overload monitoring function is not adapted, so that it may possibly not work correctly.

Details

During the acceleration process, the ramp function generator is stopped. By means of a hysteresis 2 point DC-bus voltage controller, the frequency set in `0x2541:004 (PAR 706/004)` is added to the frequency setpoint, taking the sign of the current actual frequency into consideration. Furthermore the ramp function generator is stopped in a state of overvoltage. If the DC-bus voltage falls below a defined DC-bus voltage potential of the hysteresis controller, the additional frequency connected is reduced again and the ramp function generator is re-activated. By the alternating acceleration and deceleration resulting from this circuit, the energy is converted thermally in the motor. For process-related reasons, torque oscillations may occur.

Setting instructions

Generally, the smallest value possible required by the application for being able to still traverse the load to be moved in a controlled fashion should be set as additional frequency. Greater mass inertia values require an increase in the rated motor frequency set. Increasing the rated motor frequency, however, causes greater torque oscillations. A possible consequence is the reduced service life of mechanical components. Furthermore an increase in the rated motor frequency also increases the energy converted into heat in the motor. A possible consequence is the reduced service life of the motor.

Parameter	Name / value range / [default setting]	Info
<code>0x2541:004 (PAR 706/004)</code>	Brake energy management: Additional frequency (<i>Brake management: Add.frequency</i>) 0.0 ... [0.0] ... 10.0 Hz	Frequency deviation which is connected to the deceleration ramp in a pulsative fashion when the "Inverter motor brake" braking method is used.
<code>0x2C01:005 (PAR 320/005)</code>	Motor parameters: Rated frequency (<i>Motor parameters: Mot. frequency</i>) 1.0 ... [50.0] ... 1000.0 Hz	General motor parameters. Carry out settings as specified by motor nameplate data.
<code>0x6060 (PAR 301)</code>	Modes of operation (<i>Modes of op.</i>)	Selection of the operating mode.
	-2 Lenze speed mode	
	0 Mode not changed or assigned	No operating mode (standstill).
	2 Velocity mode	

Additional functions

Load loss detection



10.5 Load loss detection

This function serves to detect a load loss and to then activate a specific function, for instance the switching of the relay.

Parameter	Name / value range / [default setting]	Info
0x4006:001 (PAR 710/001)	Load loss detection: Threshold (Load loss monit.: Load loss threshold) 0.0 ... [0.0] ... 200.0 %	Threshold for load loss detection. <ul style="list-style-type: none">The load loss detection function is activated if, with a rotating motor, the present motor current falls below the threshold set here for at least the time set in 0x4006:002 (PAR 710/002).The load loss detection status (internal "Load loss detection" trigger) can be assigned via the flexible I/O configuration, e.g. to a digital output or a relay.
0x4006:002 (PAR 710/002)	Load loss detection: Deceleration (Load loss monit.: Load loss delay) 0.0 ... [0.0] ... 300.0 s	Tripping delay for load loss detection.
0x6075 (PAR 323)	Motor rated current (Motor current) 0.001 ... [1.700]* ... 500.000 A <ul style="list-style-type: none">Default setting depending on the size.Setting can only be changed if controller inhibit is active.	The rated motor current to be set here serves as a reference value for different parameters with a setting/display in percent. Relevant parameters: <ul style="list-style-type: none">DC braking: Current 0x2B84:001 (PAR 704/001)Flying restart circuit: Current 0x2BA1:001 (PAR 718/001)Motor overload monitoring ($i^2 \cdot t$): Maximum utilisation [60 s] 0x2D4B:001 (PAR 308/001)Max current 0x6073 (PAR 324)Current actual value 0x6078 (PAR 103)
0x6078 (PAR 103)	Current actual value (Motor current %) <ul style="list-style-type: none">Read only: x.x %	Display of the present motor current. <ul style="list-style-type: none">100 % \equiv rated motor current 0x6075 (PAR 323)



10.6 **Access protection**

Additional functions

Access protection
Write access protection



10.6.1 Write access protection

Optionally a lwrite access protection function can be installed for the inverter parameters.

Details

Usually the write access protection function is implemented by the mechanical engineer/OEM , for example to protect the inverter against incorrect parameterisation by non-authorised persons.

- Only authorised persons (who know the PIN) are then allowed to change all parameters of the inverter.
- Depending on the configuration, non-authorised persons (who don't know the PIN) are not granted write access or are only allowed to change the parameters in the user menu.
- All parameters are always provided with read access.



Write access protection only restricts parameterisation via keypad and »EASY Starter«. Write access protection via network is not restricted. Irrespective of the write access protection that is currently set, a higher-level controller, OPC-UA server, or any other communication partner connected to the inverter is always provided with full read/write access to all parameters of the inverter.

Configuration of the write access protection function is carried out by setting PIN1 and/or PIN2. The following table shows the access protection variants offered by this:

PIN1 setting	PIN2 setting	Log-in	Status display after log-in	Active write access protection (via keypad/»EASY Starter«)
0x203D (PAR 730)	0x203E (PAR 731)	0x203F	0x2040 (PAR 197)	
0	0	-	0	No access protection configured.
> 0	0	0 or wrong PIN	2	Write access only possible to parameters of group 0 (Favorites).
		Correct PIN1	0	Write access to all parameters possible.
0	> 0	0 or wrong PIN	1	No write access.
		Correct PIN2	0	Write access to all parameters possible.
> 0	> 0	0 or wrong PIN	1	No write access.
		Correct PIN1	2	Write access only possible to parameters of group 0 (Favorites).
		Correct PIN2	0	Write access to all parameters possible.

»EASY Starter« provides a user-friendly parameterisation dialog for the configuration of the write access protection function. When the write access protection function has been activated, entry of the correct PIN1 or PIN2 in 0x203F is required in order to remove write access protection.

When the write access protection function is active, the keypad automatically displays an input dialog for the PIN if a change-over to parameterisation mode is effected. Set the PIN using the keypad arrow keys. After the PIN set has been accepted by means of the keypad "Enter" key, a short status display of the write access protection function is given.



Additional functions

Access protection
Write access protection

»EASY Starter« functions affected by write access protection

The following »EASY Starter« functions are not supported when write access protection is active:

- Parameter set download
- Manual check of motor rotating direction
- Definition of the user menu parameters
- Definition of the parameters for the "Parameter change-over" function
- Deletion of the logbook entries

The following »EASY Starter« functions are supported irrespective of whether write access protection is active:

- Optical device identification [0x2021:001 \(PAR 230/001\)](#)
- Enable/inhibit inverter [0x2822:001](#)
- Start/stop program
- Reset parameter to the Lenze setting [0x2022:001 \(PAR 700/001\)](#)
- Save parameter set [0x2022:003 \(PAR 700/003\)](#)
- Load user parameter [0x2022:004 \(PAR 700/004\)](#)
- Load OEM parameter [0x2022:005 \(PAR 700/005\)](#)
- Reset error [0x2631:004 \(PAR 400/004\)](#)

Parameter	Name / value range / [default setting]	Info
0x203D (PAR 730)	PIN1 access protection (PIN1 protection) -1 ... [0] ... 9999	PIN definition for write access protection. <ul style="list-style-type: none"> • 1 ... 9999 = set/change PIN. • 0 = delete PIN (deactivate access protection). • When the PIN has been set successfully, the value -1 is shown; otherwise 0. • Setting/changing the PIN via keypad/»EASY Starter« only possible if no write access protection is active. • Settings/changes via »EASY Starter« become effective immediately; via keypad they only become effective when the parameter group has been exited.
0x203E (PAR 731)	PIN2 access protection (PIN2 protection) -1 ... [0] ... 9999	PIN2 for write access protection. PIN1 for write access protection. <ul style="list-style-type: none"> • 1 ... 9999 = set/change PIN. • 0 = delete PIN (deactivate access protection). • When the PIN has been set successfully, the value -1 is shown; otherwise 0. • Setting/changing the PIN via keypad/»EASY Starter« only possible if no write access protection is active. • Settings/changes via »EASY Starter« become effective immediately; via keypad they only become effective when the parameter group has been exited. • 1 ... 9999 = set/change PIN. • 0 = delete PIN (deactivate access protection). • When the PIN has been set successfully, the value -1 is shown; otherwise 0. • Setting/changing the PIN via keypad/»EASY Starter« only possible if no write access protection is active. • Settings/changes via »EASY Starter« become effective immediately; via keypad they only become effective when the parameter group has been exited.
0x203F	PIN1/PIN2 log-in -32768 ... [0] ... 32767	Parameter for PIN entry for the purpose of deactivating an active access protection. <ul style="list-style-type: none"> • 1 ... 9999 = log-in (deactivate access protection). • 0 = log-out (reactivate access protection). • After having logged in successfully, the value 0 is shown; otherwise -1. • After 10 invalid entries, the log-in function is inhibited. In order to remove the log-in inhibit, the inverter must be switched off and on again.
0x2040 (PAR 197)	Access protection status (Protection status) <ul style="list-style-type: none"> • Read only 	Display of the active access protection after log-in via PIN1/PIN2. <ul style="list-style-type: none"> • 0 = write access to all parameters possible. • 1 = no write access. • 2 = write access only possible to parameters of group 0 (Favorites).

Additional functions

Favorites
Accessing the "Favorites" with the keypad







10.7 Favorites

In order to gain quick access using »EASY Starter« or the keypad, frequently used parameters of the inverter can be defined as "Favorites".

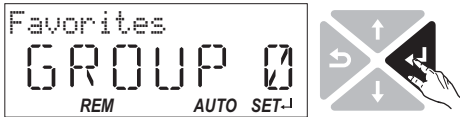
- »EASY Starter« provides quick access to the "Favorites" via the *Favorites* tab.
- On the keypad, the "Favorites" can be found in group 0.

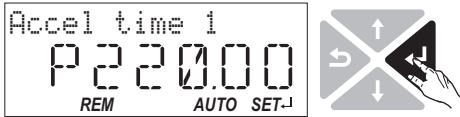
10.7.1 Accessing the "Favorites" with the keypad

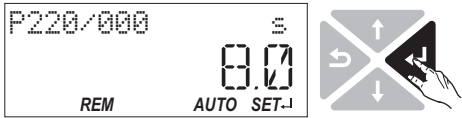
1. 
2. 
3. 
4. 
5. 
6. 

1. Use the \leftarrow key in the operating mode to navigate to the parameterisation mode one level below.
You are now in the group level. All parameters of the inverter are divided into different groups according to their function.
Group 0 contains the "Favorites".
Note: By using the \rightarrow key you can navigate one level upwards again anytime.
2. Use the \leftarrow key to navigate to one level below.
You are now in the parameter level of the group selected.
3. Use the \uparrow and \downarrow navigation keys to select the desired parameter.
4. Use the \leftarrow key to navigate to one level below.
You are now in the editing mode.
5. Set the desired value using the \uparrow and \downarrow navigation keys.
6. Use the \leftarrow key to accept the changed setting.
The editing mode is exited.
Note: By using the \rightarrow key you can exit the editing mode without accepting the new setting (abort).

10.7.2 Favorites parameter list (default setting)

In the default setting, the most common parameters for the solution of typical applications are defined as "Favorites":

No.	Display	Name	Default setting	Setting range	Info
1	P100.00	Actual frequency	x.x Hz	- (Read only)	0x2DDD (PAR 100)
2	P103.00	Motor current %	x.x %	- (Read only)	0x6078 (PAR 103)
3	P106.00	Motor voltage	x VAC	- (Read only)	0x2D89 (PAR 106)
4	P150.00	Active error	-	- (Read only)	0x603F (PAR 150)
5	P200.00	Control source	Terminal mode [0]	Selection list	0x2824 (PAR 200)
6	P201.01	Frequency setp.	Analog input 1 [2]	Selection list	0x2860:001 (PAR 201/001)
7	P203.01	Start method	Normal [0]	Selection list	0x2838:001 (PAR 203/001)
8	P203.03	Stop method	Standard Ramp [1]	Selection list	0x2838:003 (PAR 203/003)
9	P208.01	AC input volt.	230 Veff [0]	Selection list	0x2540:001 (PAR 208/001)
10	P210.00	Min. frequency	0.0 Hz	0.0 ... 599.0 Hz	0x2915 (PAR 210)
11	P211.00	Max. frequency	50.0 Hz	0.0 ... 599.0 Hz	0x2916 (PAR 211)
12	P220.00	Acceleration time 1	5.0 s	0.0 ... 3600.0 s	0x2917 (PAR 220)
13	P221.00	Deceleration time 1	5.0 s	0.0 ... 3600.0 s	0x2918 (PAR 221)
14	P300.00	Motor ctrl mode	VFC open loop [6]	Selection list	0x2C00 (PAR 300)
15	P302.00	V/f curve	Linear [0]	Selection list	0x2B00 (PAR 302)
16	P303.01	Base voltage	230 V	0 ... 5000 V	0x2B01:001 (PAR 303/001)
17	P303.02	Base frequency	50 Hz	0 ... 599 Hz	0x2B01:002 (PAR 303/002)



Additional functions

Favorites
Configuring the "Favorites"

No.	Display	Name	Default setting	Setting range	Info
18	P304.00	Rotation mode	Forwards/backw. [1]	Selection list	0x283A (PAR 304)
19	P305.00	Switching frequency	8kHz var/opt/4 [21]	Selection list	0x2939 (PAR 305)
20	P308.01	Load at 60 sec	150 %	30 ... 200 %	0x2D4B:001 (PAR 308/001)
21	P316.01	V/f boost: stat.	2.5 %	0.0 ... 20.0 %	0x2B12:001 (PAR 316/001)
22	P324.00	Max current	200.0 %	0.0 ... 3000.0 %	0x6073 (PAR 324)
23	P400.01	Controller enable	TRUE [1]	Selection list	0x2631:001 (PAR 400/001)
24	P400.02	Start enable	Digital input 1 [11]	Selection list	0x2631:002 (PAR 400/002)
25	P400.03	Quick stop	Not connected [0]	Selection list	0x2631:003 (PAR 400/003)
26	P400.04	Reset error	Digital input 2 [12]	Selection list	0x2631:004 (PAR 400/004)
27	P400.05	DC braking	Not connected [0]	Selection list	0x2631:005 (PAR 400/005)
28	P400.06	Forward start	Not connected [0]	Selection list	0x2631:006 (PAR 400/006)
29	P400.07	Backward start	Not connected [0]	Selection list	0x2631:007 (PAR 400/007)
30	P400.08	Forward run	Not connected [0]	Selection list	0x2631:008 (PAR 400/008)
31	P400.09	Backward run	Not connected [0]	Selection list	0x2631:009 (PAR 400/009)
32	P400.13	Reversal of rot. dir.	Digital input 3 [13]	Selection list	0x2631:013 (PAR 400/013)
33	P400.18	Preset b0	Digital input 4 [14]	Selection list	0x2631:018 (PAR 400/018)
34	P400.19	Preset b1	Digital input 5 [15]	Selection list	0x2631:019 (PAR 400/019)
35	P400.20	Preset b2	Not connected [0]	Selection list	0x2631:020 (PAR 400/020)
36	P420.01	Relay function	Ready for operation [51]	Selection list	0x2634:001 (PAR 420/001)
37	P420.02	DO1 function	Release brake [115]	Selection list	0x2634:002 (PAR 420/002)
38	P430.01	AI1 config.	0...10VDC [0]	Selection list	0x2636:001 (PAR 430/001)
39	P430.02	AI1 freq @ min	0.0 Hz	-1000.0 ... 1000.0 Hz	0x2636:002 (PAR 430/002)
40	P430.03	AI1 freq @ max	50.0 Hz	-1000.0 ... 1000.0 Hz	0x2636:003 (PAR 430/003)
41	P440.01	AO1 config.	0...10VDC [1]	Selection list	0x2639:001 (PAR 440/001)
42	P440.02	AO1 function	Actual outp. freq. [1]	Selection list	0x2639:002 (PAR 440/002)
43	P440.03	AO1 funct @ min	0	-2147483648 ... 2147483647	0x2639:003 (PAR 440/003)
44	P440.04	AO1 funct @ max	1000	-2147483648 ... 2147483647	0x2639:004 (PAR 440/004)
45	P450.01	Preset value 1	20.0 Hz	0.0 ... 599.0 Hz	0x2911:001 (PAR 450/001)
46	P450.02	Preset value 2	40.0 Hz	0.0 ... 599.0 Hz	0x2911:002 (PAR 450/002)
47	P450.03	Preset value 3	50.0 Hz	0.0 ... 599.0 Hz	0x2911:003 (PAR 450/003)
48	P450.04	Preset value 4	0.0 Hz	0.0 ... 599.0 Hz	0x2911:004 (PAR 450/004)
49	-	-	-	-	not assigned
50	-	-	-	-	not assigned

10.7.3 Configuring the "Favorites"

The "Favorites" can be configured by the user.

Details

- »EASY Starter« provides a user-friendly parameterisation dialog for configuration of the "Favorites".
- A maximum number of 50 parameters can be defined as "Favorites".

Parameter	Name / value range / [default setting]	Info
0x261C:001 (PAR 740/001)	Favorites settings: Parameter 1 (Favorites sett.: Favorites pos 1) 0x00000000 ... [0x2DDD0000] ... 0xFFFFFFFF00	Definition of the "Favorites" parameters. <ul style="list-style-type: none"> • Format: 0xiiii:ss00 (iiii = hexadecimal index, ss = hexadecimal subindex) • The lowest byte is always 0x00. • Keypad format: Piii.ss (iii = decimal PAR number, ss = decimal subindex)
0x261C:002 (PAR 740/002)	Favorites settings: Parameter 2 (Favorites sett.: Favorites pos 2) 0x00000000 ... [0x60780000] ... 0xFFFFFFFF00	
0x261C:003 (PAR 740/003)	Favorites settings: Parameter 3 (Favorites sett.: Favorites pos 3) 0x00000000 ... [0x2D890000] ... 0xFFFFFFFF00	
0x261C:004 (PAR 740/004)	Favorites settings: Parameter 4 (Favorites sett.: Favorites pos 4) 0x00000000 ... [0x603F0000] ... 0xFFFFFFFF00	

Additional functions

Favorites
Configuring the "Favorites"



Parameter	Name / value range / [default setting]	Info
0x261C:005 (PAR 740/005)	Favorites settings: Parameter 5 (Favorites sett.: Favorites pos 5) 0x00000000 ... [0x28240000] ... 0xFFFFFFFF00	
0x261C:006 (PAR 740/006)	Favorites settings: Parameter 6 (Favorites sett.: Favorites pos 6) 0x00000000 ... [0x28600100] ... 0xFFFFFFFF00	
0x261C:007 (PAR 740/007)	Favorites settings: Parameter 7 (Favorites sett.: Favorites pos 7) 0x00000000 ... [0x28380100] ... 0xFFFFFFFF00	
0x261C:008 (PAR 740/008)	Favorites settings: Parameter 8 (Favorites sett.: Favorites pos 8) 0x00000000 ... [0x28380300] ... 0xFFFFFFFF00	
0x261C:009 (PAR 740/009)	Favorites settings: Parameter 9 (Favorites sett.: Favorites pos 9) 0x00000000 ... [0x25400100] ... 0xFFFFFFFF00	
0x261C:010 (PAR 740/010)	Favorites settings: Parameter 10 (Favorites sett.: Favorites pos 10) 0x00000000 ... [0x29150000] ... 0xFFFFFFFF00	
0x261C:011 (PAR 740/011)	Favorites settings: Parameter 11 (Favorites sett.: Favorites pos 11) 0x00000000 ... [0x29160000] ... 0xFFFFFFFF00	
0x261C:012 (PAR 740/012)	Favorites settings: Parameter 12 (Favorites sett.: Favorites pos 12) 0x00000000 ... [0x29170000] ... 0xFFFFFFFF00	
0x261C:013 (PAR 740/013)	Favorites settings: Parameter 13 (Favorites sett.: Favorites pos 13) 0x00000000 ... [0x29180000] ... 0xFFFFFFFF00	
0x261C:014 (PAR 740/014)	Favorites settings: Parameter 14 (Favorites sett.: Favorites pos 14) 0x00000000 ... [0x2C000000] ... 0xFFFFFFFF00	
0x261C:015 (PAR 740/015)	Favorites settings: Parameter 15 (Favorites sett.: Favorites pos 15) 0x00000000 ... [0x2B000000] ... 0xFFFFFFFF00	
0x261C:016 (PAR 740/016)	Favorites settings: Parameter 16 (Favorites sett.: Favorites pos 16) 0x00000000 ... [0x2B010100] ... 0xFFFFFFFF00	
0x261C:017 (PAR 740/017)	Favorites settings: Parameter 17 (Favorites sett.: Favorites pos 17) 0x00000000 ... [0x2B010200] ... 0xFFFFFFFF00	
0x261C:018 (PAR 740/018)	Favorites settings: Parameter 18 (Favorites sett.: Favorites pos 18) 0x00000000 ... [0x283A0000] ... 0xFFFFFFFF00	
0x261C:019 (PAR 740/019)	Favorites settings: Parameter 19 (Favorites sett.: Favorites pos 19) 0x00000000 ... [0x29390000] ... 0xFFFFFFFF00	
0x261C:020 (PAR 740/020)	Favorites settings: Parameter 20 (Favorites sett.: Favorites pos 20) 0x00000000 ... [0x2D4B0100] ... 0xFFFFFFFF00	
0x261C:021 (PAR 740/021)	Favorites settings: Parameter 21 (Favorites sett.: Favorites pos 21) 0x00000000 ... [0x2B120100] ... 0xFFFFFFFF00	
0x261C:022 (PAR 740/022)	Favorites settings: Parameter 22 (Favorites sett.: Favorites pos 22) 0x00000000 ... [0x60730000] ... 0xFFFFFFFF00	
0x261C:023 (PAR 740/023)	Favorites settings: Parameter 23 (Favorites sett.: Favorites pos 23) 0x00000000 ... [0x26310100] ... 0xFFFFFFFF00	
0x261C:024 (PAR 740/024)	Favorites settings: Parameter 24 (Favorites sett.: Favorites pos 24) 0x00000000 ... [0x26310200] ... 0xFFFFFFFF00	
0x261C:025 (PAR 740/025)	Favorites settings: Parameter 25 (Favorites sett.: Favorites pos 25) 0x00000000 ... [0x26310300] ... 0xFFFFFFFF00	



Additional functions

Favorites
Configuring the "Favorites"

Parameter	Name / value range / [default setting]	Info
0x261C:026 (PAR 740/026)	Favorites settings: Parameter 26 (Favorites sett.: Favorites pos 26) 0x00000000 ... [0x26310400] ... 0xFFFFFFFF00	
0x261C:027 (PAR 740/027)	Favorites settings: Parameter 27 (Favorites sett.: Favorites pos 27) 0x00000000 ... [0x26310500] ... 0xFFFFFFFF00	
0x261C:028 (PAR 740/028)	Favorites settings: Parameter 28 (Favorites sett.: Favorites pos 28) 0x00000000 ... [0x26310600] ... 0xFFFFFFFF00	
0x261C:029 (PAR 740/029)	Favorites settings: Parameter 29 (Favorites sett.: Favorites pos 29) 0x00000000 ... [0x26310700] ... 0xFFFFFFFF00	
0x261C:030 (PAR 740/030)	Favorites settings: Parameter 30 (Favorites sett.: Favorites pos 30) 0x00000000 ... [0x26310800] ... 0xFFFFFFFF00	
0x261C:031 (PAR 740/031)	Favorites settings: Parameter 31 (Favorites sett.: Favorites pos 31) 0x00000000 ... [0x26310900] ... 0xFFFFFFFF00	
0x261C:032 (PAR 740/032)	Favorites settings: Parameter 32 (Favorites sett.: Favorites pos 32) 0x00000000 ... [0x26310D00] ... 0xFFFFFFFF00	
0x261C:033 (PAR 740/033)	Favorites settings: Parameter 33 (Favorites sett.: Favorites pos 33) 0x00000000 ... [0x26311200] ... 0xFFFFFFFF00	
0x261C:034 (PAR 740/034)	Favorites settings: Parameter 34 (Favorites sett.: Favorites pos 34) 0x00000000 ... [0x26311300] ... 0xFFFFFFFF00	
0x261C:035 (PAR 740/035)	Favorites settings: Parameter 35 (Favorites sett.: Favorites pos 35) 0x00000000 ... [0x26311400] ... 0xFFFFFFFF00	
0x261C:036 (PAR 740/036)	Favorites settings: Parameter 36 (Favorites sett.: Favorites pos 36) 0x00000000 ... [0x26340100] ... 0xFFFFFFFF00	
0x261C:037 (PAR 740/037)	Favorites settings: Parameter 37 (Favorites sett.: Favorites pos 37) 0x00000000 ... [0x26340200] ... 0xFFFFFFFF00	
0x261C:038 (PAR 740/038)	Favorites settings: Parameter 38 (Favorites sett.: Favorites pos 38) 0x00000000 ... [0x26360100] ... 0xFFFFFFFF00	
0x261C:039 (PAR 740/039)	Favorites settings: Parameter 39 (Favorites sett.: Favorites pos 39) 0x00000000 ... [0x26360200] ... 0xFFFFFFFF00	
0x261C:040 (PAR 740/040)	Favorites settings: Parameter 40 (Favorites sett.: Favorites pos 40) 0x00000000 ... [0x26360300] ... 0xFFFFFFFF00	
0x261C:041 (PAR 740/041)	Favorites settings: Parameter 41 (Favorites sett.: Favorites pos 41) 0x00000000 ... [0x26390100] ... 0xFFFFFFFF00	
0x261C:042 (PAR 740/042)	Favorites settings: Parameter 42 (Favorites sett.: Favorites pos 42) 0x00000000 ... [0x26390200] ... 0xFFFFFFFF00	
0x261C:043 (PAR 740/043)	Favorites settings: Parameter 43 (Favorites sett.: Favorites pos 43) 0x00000000 ... [0x26390300] ... 0xFFFFFFFF00	
0x261C:044 (PAR 740/044)	Favorites settings: Parameter 44 (Favorites sett.: Favorites pos 44) 0x00000000 ... [0x26390400] ... 0xFFFFFFFF00	
0x261C:045 (PAR 740/045)	Favorites settings: Parameter 45 (Favorites sett.: Favorites pos 45) 0x00000000 ... [0x29110100] ... 0xFFFFFFFF00	
0x261C:046 (PAR 740/046)	Favorites settings: Parameter 46 (Favorites sett.: Favorites pos 46) 0x00000000 ... [0x29110200] ... 0xFFFFFFFF00	

Additional functions

Favorites

Configuring the "Favorites"



Parameter	Name / value range / [default setting]	Info
0x261C:047 (PAR 740/047)	Favorites settings: Parameter 47 (Favorites sett.: Favorites pos 47) 0x00000000 ... [0x29110300] ... 0xFFFFFFFF00	
0x261C:048 (PAR 740/048)	Favorites settings: Parameter 48 (Favorites sett.: Favorites pos 48) 0x00000000 ... [0x29110400] ... 0xFFFFFFFF00	
0x261C:049 (PAR 740/049)	Favorites settings: Parameter 49 (Favorites sett.: Favorites pos 49) 0x00000000 ... [0x00000000] ... 0xFFFFFFFF00	
0x261C:050 (PAR 740/050)	Favorites settings: Parameter 50 (Favorites sett.: Favorites pos 50) 0x00000000 ... [0x00000000] ... 0xFFFFFFFF00	



10.8 Parameter change-over

For up to 32 freely selectable parameters, this function provides a change-over between four sets with different parameter values.

⚠ DANGER!

Changed parameter settings are effective immediately.

The possible consequence is an unexpected response of the motor shaft while the inverter is enabled.

- ▶ If possible, only carry out parameter changes while the controller is inhibited.
- ▶ Certain device commands or settings which might cause a critical state of the drive behaviour can generally only be carried out with controller inhibit.

Details

The parameter list is compiled in the same way as that of the "Favorites" via parameterisation. »EASY Starter« provides a user-friendly parameterisation dialog for this purpose.

Change-over to another value set can optionally be effected via corresponding device commands and/or special functions/triggers:

▶ [Device commands for parameter change-over](#) 148

▶ [Functions for parameter change-over](#) 206

Parameter	Name / value range / [default setting]	Info
0x2022:011 (PAR 700/011)	Device commands: Save parameter set 1 (Device commands: Save par. set 1)	1 = save value set 1 of the "Parameter change-over" function. • When the device command has been executed successfully, the value 0 is shown.
	0 Off / ready	Only status feedback.
	1 On / start	Execute device command.
	2 In progress	Only status feedback.
	3 Action cancelled	
	4 No access	
5 No access (controller inhibit)		
0x2022:012 (PAR 700/012)	Device commands: Save parameter set 2 (Device commands: Save par. set 2)	1 = save value set 2 of the "Parameter change-over" function. • When the device command has been executed successfully, the value 0 is shown.
	0 Off / ready	Only status feedback.
	1 On / start	Execute device command.
	2 In progress	Only status feedback.
	3 Action cancelled	
	4 No access	
5 No access (controller inhibit)		
0x2022:013 (PAR 700/013)	Device commands: Save parameter set 3 (Device commands: Save par. set 3)	1 = save value set 3 of the "Parameter change-over" function. • When the device command has been executed successfully, the value 0 is shown.
	0 Off / ready	Only status feedback.
	1 On / start	Execute device command.
	2 In progress	Only status feedback.
	3 Action cancelled	
	4 No access	
5 No access (controller inhibit)		

Additional functions

Parameter change-over



Parameter	Name / value range / [default setting]	Info
0x2022:014 (PAR 700/014)	Device commands: Save parameter set 4 (Device commands: Save par. set 4)	1 = save value set 3 of the "Parameter change-over" function. • When the device command has been executed successfully, the value 0 is shown.
	0 Off / ready	Only status feedback.
	1 On / start	Execute device command.
	2 In progress	Only status feedback.
	3 Action cancelled	
	4 No access	
5 No access (controller inhibit)		
0x4041:001 (PAR 750/001)	Parameter change-over: Parameter 1 (Param. set setup: Parameter 1) 0x00000000 ... [0x00000000] ... 0xFFFFFFFF	Definition of the parameter list for the "Parameter change-over" function. • Format: 0xiiii00 (iiii = hexadecimal index, ss = hexadecimal subindex) • The lowest byte is always 0x00.
0x4041:002 (PAR 750/002)	Parameter change-over: Parameter 2 (Param. set setup: Parameter 2) 0x00000000 ... [0x00000000] ... 0xFFFFFFFF	
0x4041:003 (PAR 750/003)	Parameter change-over: Parameter 3 (Param. set setup: Parameter 3) 0x00000000 ... [0x00000000] ... 0xFFFFFFFF	
0x4041:004 (PAR 750/004)	Parameter change-over: Parameter 4 (Param. set setup: Parameter 4) 0x00000000 ... [0x00000000] ... 0xFFFFFFFF	
0x4041:005 (PAR 750/005)	Parameter change-over: Parameter 5 (Param. set setup: Parameter 5) 0x00000000 ... [0x00000000] ... 0xFFFFFFFF	
0x4041:006 (PAR 750/006)	Parameter change-over: Parameter 6 (Param. set setup: Parameter 6) 0x00000000 ... [0x00000000] ... 0xFFFFFFFF	
0x4041:007 (PAR 750/007)	Parameter change-over: Parameter 7 (Param. set setup: Parameter 7) 0x00000000 ... [0x00000000] ... 0xFFFFFFFF	
0x4041:008 (PAR 750/008)	Parameter change-over: Parameter 8 (Param. set setup: Parameter 8) 0x00000000 ... [0x00000000] ... 0xFFFFFFFF	
0x4041:009 (PAR 750/009)	Parameter change-over: Parameter 9 (Param. set setup: CodeParameter) 0x00000000 ... [0x00000000] ... 0xFFFFFFFF	
0x4041:010 (PAR 750/010)	Parameter change-over: Parameter 10 (Param. set setup: Parameter 10) 0x00000000 ... [0x00000000] ... 0xFFFFFFFF	
0x4041:011 (PAR 750/011)	Parameter change-over: Parameter 11 (Param. set setup: Parameter 11) 0x00000000 ... [0x00000000] ... 0xFFFFFFFF	
0x4041:012 (PAR 750/012)	Parameter change-over: Parameter 12 (Param. set setup: Parameter 12) 0x00000000 ... [0x00000000] ... 0xFFFFFFFF	
0x4041:013 (PAR 750/013)	Parameter change-over: Parameter 13 (Param. set setup: Parameter 13) 0x00000000 ... [0x00000000] ... 0xFFFFFFFF	
0x4041:014 (PAR 750/014)	Parameter change-over: Parameter 14 (Param. set setup: Parameter 14) 0x00000000 ... [0x00000000] ... 0xFFFFFFFF	
0x4041:015 (PAR 750/015)	Parameter change-over: Parameter 15 (Param. set setup: Parameter 15) 0x00000000 ... [0x00000000] ... 0xFFFFFFFF	
0x4041:016 (PAR 750/016)	Parameter change-over: Parameter 16 (Param. set setup: Parameter 16) 0x00000000 ... [0x00000000] ... 0xFFFFFFFF	
0x4041:017 (PAR 750/017)	Parameter change-over: Parameter 17 (Param. set setup: Parameter 17) 0x00000000 ... [0x00000000] ... 0xFFFFFFFF	



Additional functions

Parameter change-over

Parameter	Name / value range / [default setting]	Info
0x4041:018 (PAR 750/018)	Parameter change-over: Parameter 18 (Param. set setup: Parameter 18) 0x00000000 ... [0x00000000] ... 0xFFFFFFFF00	
0x4041:019 (PAR 750/019)	Parameter change-over: Parameter 19 (Param. set setup: Parameter 19) 0x00000000 ... [0x00000000] ... 0xFFFFFFFF00	
0x4041:020 (PAR 750/020)	Parameter change-over: Parameter 20 (Param. set setup: Parameter 20) 0x00000000 ... [0x00000000] ... 0xFFFFFFFF00	
0x4041:021 (PAR 750/021)	Parameter change-over: Parameter 21 (Param. set setup: Parameter 21) 0x00000000 ... [0x00000000] ... 0xFFFFFFFF00	
0x4041:022 (PAR 750/022)	Parameter change-over: Parameter 22 (Param. set setup: Parameter 22) 0x00000000 ... [0x00000000] ... 0xFFFFFFFF00	
0x4041:023 (PAR 750/023)	Parameter change-over: Parameter 23 (Param. set setup: Parameter 23) 0x00000000 ... [0x00000000] ... 0xFFFFFFFF00	
0x4041:024 (PAR 750/024)	Parameter change-over: Parameter 24 (Param. set setup: Parameter 24) 0x00000000 ... [0x00000000] ... 0xFFFFFFFF00	
0x4041:025 (PAR 750/025)	Parameter change-over: Parameter 25 (Param. set setup: Parameter 25) 0x00000000 ... [0x00000000] ... 0xFFFFFFFF00	
0x4041:026 (PAR 750/026)	Parameter change-over: Parameter 26 (Param. set setup: Parameter 26) 0x00000000 ... [0x00000000] ... 0xFFFFFFFF00	
0x4041:027 (PAR 750/027)	Parameter change-over: Parameter 27 (Param. set setup: Parameter 27) 0x00000000 ... [0x00000000] ... 0xFFFFFFFF00	
0x4041:028 (PAR 750/028)	Parameter change-over: Parameter 28 (Param. set setup: Parameter 28) 0x00000000 ... [0x00000000] ... 0xFFFFFFFF00	
0x4041:029 (PAR 750/029)	Parameter change-over: Parameter 29 (Param. set setup: Parameter 29) 0x00000000 ... [0x00000000] ... 0xFFFFFFFF00	
0x4041:030 (PAR 750/030)	Parameter change-over: Parameter 30 (Param. set setup: Parameter 30) 0x00000000 ... [0x00000000] ... 0xFFFFFFFF00	
0x4041:031 (PAR 750/031)	Parameter change-over: Parameter 31 (Param. set setup: Parameter 31) 0x00000000 ... [0x00000000] ... 0xFFFFFFFF00	
0x4041:032 (PAR 750/032)	Parameter change-over: Parameter 32 (Param. set setup: Parameter 32) 0x00000000 ... [0x00000000] ... 0xFFFFFFFF00	
0x4042:001 (PAR 751/001)	Parameter value set 1: Value of parameter 1 (Param. set 1: Set1: Value 1) -2147483648 ... [0] ... 2147483647	Value set 1 for the parameter list defined in 0x4041:001 (PAR 750/001).
0x4042:002 (PAR 751/002)	Parameter value set 1: Value of parameter 2 (Param. set 1: Set1: value 2) -2147483648 ... [0] ... 2147483647	
0x4042:003 (PAR 751/003)	Parameter value set 1: Value of parameter 3 (Param. set 1: Set1: value 3) -2147483648 ... [0] ... 2147483647	
0x4042:004 (PAR 751/004)	Parameter value set 1: Value of parameter 4 (Param. set 1: Set1: value 4) -2147483648 ... [0] ... 2147483647	
0x4042:005 (PAR 751/005)	Parameter value set 1: Value of parameter 5 (Param. set 1: Set1: value 5) -2147483648 ... [0] ... 2147483647	
0x4042:006 (PAR 751/006)	Parameter value set 1: Value of parameter 6 (Param. set 1: Set1: value 6) -2147483648 ... [0] ... 2147483647	

Additional functions

Parameter change-over



Parameter	Name / value range / [default setting]	Info
0x4042:007 (PAR 751/007)	Parameter value set 1: Value of parameter 7 (Param. set 1: Set1: value 7) -2147483648 ... [0] ... 2147483647	
0x4042:008 (PAR 751/008)	Parameter value set 1: Value of parameter 8 (Param. set 1: Set1: value 8) -2147483648 ... [0] ... 2147483647	
0x4042:009 (PAR 751/009)	Parameter value set 1: Value of parameter 9 (Param. set 1: Set1: value 9) -2147483648 ... [0] ... 2147483647	
0x4042:010 (PAR 751/010)	Parameter value set 1: Value of parameter 10 (Param. set 1: Set1: value 10) -2147483648 ... [0] ... 2147483647	
0x4042:011 (PAR 751/011)	Parameter value set 1: Value of parameter 11 (Param. set 1: Set1: value 11) -2147483648 ... [0] ... 2147483647	
0x4042:012 (PAR 751/012)	Parameter value set 1: Value of parameter 12 (Param. set 1: Set1: value 12) -2147483648 ... [0] ... 2147483647	
0x4042:013 (PAR 751/013)	Parameter value set 1: Value of parameter 13 (Param. set 1: Set1: value 13) -2147483648 ... [0] ... 2147483647	
0x4042:014 (PAR 751/014)	Parameter value set 1: Value of parameter 14 (Param. set 1: Set1: value 14) -2147483648 ... [0] ... 2147483647	
0x4042:015 (PAR 751/015)	Parameter value set 1: Value of parameter 15 (Param. set 1: Set1: value 15) -2147483648 ... [0] ... 2147483647	
0x4042:016 (PAR 751/016)	Parameter value set 1: Value of parameter 16 (Param. set 1: Set1: value 16) -2147483648 ... [0] ... 2147483647	
0x4042:017 (PAR 751/017)	Parameter value set 1: Value of parameter 17 (Param. set 1: Set1: value 17) -2147483648 ... [0] ... 2147483647	
0x4042:018 (PAR 751/018)	Parameter value set 1: Value of parameter 18 (Param. set 1: Set1: value 18) -2147483648 ... [0] ... 2147483647	
0x4042:019 (PAR 751/019)	Parameter value set 1: Value of parameter 19 (Param. set 1: Set1: value 19) -2147483648 ... [0] ... 2147483647	
0x4042:020 (PAR 751/020)	Parameter value set 1: Value of parameter 20 (Param. set 1: Set1: value 20) -2147483648 ... [0] ... 2147483647	
0x4042:021 (PAR 751/021)	Parameter value set 1: Value of parameter 21 (Param. set 1: Set1: value 21) -2147483648 ... [0] ... 2147483647	
0x4042:022 (PAR 751/022)	Parameter value set 1: Value of parameter 22 (Param. set 1: Set1: value 22) -2147483648 ... [0] ... 2147483647	
0x4042:023 (PAR 751/023)	Parameter value set 1: Value of parameter 23 (Param. set 1: Set1: value 23) -2147483648 ... [0] ... 2147483647	
0x4042:024 (PAR 751/024)	Parameter value set 1: Value of parameter 24 (Param. set 1: Set1: value 24) -2147483648 ... [0] ... 2147483647	
0x4042:025 (PAR 751/025)	Parameter value set 1: Value of parameter 25 (Param. set 1: Set1: value 25) -2147483648 ... [0] ... 2147483647	
0x4042:026 (PAR 751/026)	Parameter value set 1: Value of parameter 26 (Param. set 1: Set1: value 26) -2147483648 ... [0] ... 2147483647	
0x4042:027 (PAR 751/027)	Parameter value set 1: Value of parameter 27 (Param. set 1: Set1: value 27) -2147483648 ... [0] ... 2147483647	



Additional functions

Parameter change-over

Parameter	Name / value range / [default setting]	Info
0x4042:028 (PAR 751/028)	Parameter value set 1: Value of parameter 28 (Param. set 1: Set1: value 28) -2147483648 ... [0] ... 2147483647	
0x4042:029 (PAR 751/029)	Parameter value set 1: Value of parameter 29 (Param. set 1: Set1: value 29) -2147483648 ... [0] ... 2147483647	
0x4042:030 (PAR 751/030)	Parameter value set 1: Value of parameter 30 (Param. set 1: Set1: value 30) -2147483648 ... [0] ... 2147483647	
0x4042:031 (PAR 751/031)	Parameter value set 1: Value of parameter 31 (Param. set 1: Set1: value 31) -2147483648 ... [0] ... 2147483647	
0x4042:032 (PAR 751/032)	Parameter value set 1: Value of parameter 32 (Param. set 1: Set1: value 32) -2147483648 ... [0] ... 2147483647	
0x4043:001 (PAR 752/001)	Parameter value set 2: Value of parameter 1 (Param. set 2: Set2: value 1) -2147483648 ... [0] ... 2147483647	Value set 2 for the parameter list defined in 0x4041:001 (PAR 750/001) .
0x4043:002 (PAR 752/002)	Parameter value set 2: Value of parameter 2 (Param. set 2: Set2: value 2) -2147483648 ... [0] ... 2147483647	
0x4043:003 (PAR 752/003)	Parameter value set 2: Value of parameter 3 (Param. set 2: Set2: value 3) -2147483648 ... [0] ... 2147483647	
0x4043:004 (PAR 752/004)	Parameter value set 2: Value of parameter 4 (Param. set 2: Set2: value 4) -2147483648 ... [0] ... 2147483647	
0x4043:005 (PAR 752/005)	Parameter value set 2: Value of parameter 5 (Param. set 2: Set2: value 5) -2147483648 ... [0] ... 2147483647	
0x4043:006 (PAR 752/006)	Parameter value set 2: Value of parameter 6 (Param. set 2: Set2: value 6) -2147483648 ... [0] ... 2147483647	
0x4043:007 (PAR 752/007)	Parameter value set 2: Value of parameter 7 (Param. set 2: Set2: value 7) -2147483648 ... [0] ... 2147483647	
0x4043:008 (PAR 752/008)	Parameter value set 2: Value of parameter 8 (Param. set 2: Set2: value 8) -2147483648 ... [0] ... 2147483647	
0x4043:009 (PAR 752/009)	Parameter value set 2: Value of parameter 9 (Param. set 2: Set2: value 9) -2147483648 ... [0] ... 2147483647	
0x4043:010 (PAR 752/010)	Parameter value set 2: Value of parameter 10 (Param. set 2: Set2: value 10) -2147483648 ... [0] ... 2147483647	
0x4043:011 (PAR 752/011)	Parameter value set 2: Value of parameter 11 (Param. set 2: Set2: value 11) -2147483648 ... [0] ... 2147483647	
0x4043:012 (PAR 752/012)	Parameter value set 2: Value of parameter 12 (Param. set 2: Set2: value 12) -2147483648 ... [0] ... 2147483647	
0x4043:013 (PAR 752/013)	Parameter value set 2: Value of parameter 13 (Param. set 2: Set2: value 13) -2147483648 ... [0] ... 2147483647	
0x4043:014 (PAR 752/014)	Parameter value set 2: Value of parameter 14 (Param. set 2: Set2: value 14) -2147483648 ... [0] ... 2147483647	
0x4043:015 (PAR 752/015)	Parameter value set 2: Value of parameter 15 (Param. set 2: Set2: value 15) -2147483648 ... [0] ... 2147483647	
0x4043:016 (PAR 752/016)	Parameter value set 2: Value of parameter 16 (Param. set 2: Set2: value 16) -2147483648 ... [0] ... 2147483647	

Additional functions

Parameter change-over



Parameter	Name / value range / [default setting]	Info
0x4043:017 (PAR 752/017)	Parameter value set 2: Value of parameter 17 (Param. set 2: Set2: value 17) -2147483648 ... [0] ... 2147483647	
0x4043:018 (PAR 752/018)	Parameter value set 2: Value of parameter 18 (Param. set 2: Set2: value 18) -2147483648 ... [0] ... 2147483647	
0x4043:019 (PAR 752/019)	Parameter value set 2: Value of parameter 19 (Param. set 2: Set2: value 19) -2147483648 ... [0] ... 2147483647	
0x4043:020 (PAR 752/020)	Parameter value set 2: Value of parameter 20 (Param. set 2: Set2: value 20) -2147483648 ... [0] ... 2147483647	
0x4043:021 (PAR 752/021)	Parameter value set 2: Value of parameter 21 (Param. set 2: Set2: value 21) -2147483648 ... [0] ... 2147483647	
0x4043:022 (PAR 752/022)	Parameter value set 2: Value of parameter 22 (Param. set 2: Set2: value 22) -2147483648 ... [0] ... 2147483647	
0x4043:023 (PAR 752/023)	Parameter value set 2: Value of parameter 23 (Param. set 2: Set2: value 23) -2147483648 ... [0] ... 2147483647	
0x4043:024 (PAR 752/024)	Parameter value set 2: Value of parameter 24 (Param. set 2: Set2: value 24) -2147483648 ... [0] ... 2147483647	
0x4043:025 (PAR 752/025)	Parameter value set 2: Value of parameter 25 (Param. set 2: Set2: value 25) -2147483648 ... [0] ... 2147483647	
0x4043:026 (PAR 752/026)	Parameter value set 2: Value of parameter 26 (Param. set 2: Set2: value 26) -2147483648 ... [0] ... 2147483647	
0x4043:027 (PAR 752/027)	Parameter value set 2: Value of parameter 27 (Param. set 2: Set2: value 27) -2147483648 ... [0] ... 2147483647	
0x4043:028 (PAR 752/028)	Parameter value set 2: Value of parameter 28 (Param. set 2: Set2: value 28) -2147483648 ... [0] ... 2147483647	
0x4043:029 (PAR 752/029)	Parameter value set 2: Value of parameter 29 (Param. set 2: Set2: value 29) -2147483648 ... [0] ... 2147483647	
0x4043:030 (PAR 752/030)	Parameter value set 2: Value of parameter 30 (Param. set 2: Set2: value 30) -2147483648 ... [0] ... 2147483647	
0x4043:031 (PAR 752/031)	Parameter value set 2: Value of parameter 31 (Param. set 2: Set2: value 31) -2147483648 ... [0] ... 2147483647	
0x4043:032 (PAR 752/032)	Parameter value set 2: Value of parameter 32 (Param. set 2: Set2: value 32) -2147483648 ... [0] ... 2147483647	
0x4044:001 (PAR 753/001)	Parameter value set 3: Value of parameter 1 (Param. set 3: Set3: Value 1) -2147483648 ... [0] ... 2147483647	Value set 3 for the parameter list defined in 0x4041:001 (PAR 750/001).
0x4044:002 (PAR 753/002)	Parameter value set 3: Value of parameter 2 (Param. set 3: Set3: value 2) -2147483648 ... [0] ... 2147483647	
0x4044:003 (PAR 753/003)	Parameter value set 3: Value of parameter 3 (Param. set 3: Set3: value 3) -2147483648 ... [0] ... 2147483647	
0x4044:004 (PAR 753/004)	Parameter value set 3: Value of parameter 4 (Param. set 3: Set3: value 4) -2147483648 ... [0] ... 2147483647	
0x4044:005 (PAR 753/005)	Parameter value set 3: Value of parameter 5 (Param. set 3: Set3: value 5) -2147483648 ... [0] ... 2147483647	



Additional functions

Parameter change-over

Parameter	Name / value range / [default setting]	Info
0x4044:006 (PAR 753/006)	Parameter value set 3: Value of parameter 6 (Param. set 3: Set3: value 6) -2147483648 ... [0] ... 2147483647	
0x4044:007 (PAR 753/007)	Parameter value set 3: Value of parameter 7 (Param. set 3: Set3: value 7) -2147483648 ... [0] ... 2147483647	
0x4044:008 (PAR 753/008)	Parameter value set 3: Value of parameter 8 (Param. set 3: Set3: value 8) -2147483648 ... [0] ... 2147483647	
0x4044:009 (PAR 753/009)	Parameter value set 3: Value of parameter 9 (Param. set 3: Set3: value 9) -2147483648 ... [0] ... 2147483647	
0x4044:010 (PAR 753/010)	Parameter value set 3: Value of parameter 10 (Param. set 3: Set3: value 10) -2147483648 ... [0] ... 2147483647	
0x4044:011 (PAR 753/011)	Parameter value set 3: Value of parameter 11 (Param. set 3: Set3: value 11) -2147483648 ... [0] ... 2147483647	
0x4044:012 (PAR 753/012)	Parameter value set 3: Value of parameter 12 (Param. set 3: Set3: value 12) -2147483648 ... [0] ... 2147483647	
0x4044:013 (PAR 753/013)	Parameter value set 3: Value of parameter 13 (Param. set 3: Set3: value 13) -2147483648 ... [0] ... 2147483647	
0x4044:014 (PAR 753/014)	Parameter value set 3: Value of parameter 14 (Param. set 3: Set3: value 14) -2147483648 ... [0] ... 2147483647	
0x4044:015 (PAR 753/015)	Parameter value set 3: Value of parameter 15 (Param. set 3: Set3: value 15) -2147483648 ... [0] ... 2147483647	
0x4044:016 (PAR 753/016)	Parameter value set 3: Value of parameter 16 (Param. set 3: Set3: value 16) -2147483648 ... [0] ... 2147483647	
0x4044:017 (PAR 753/017)	Parameter value set 3: Value of parameter 17 (Param. set 3: Set3: value 17) -2147483648 ... [0] ... 2147483647	
0x4044:018 (PAR 753/018)	Parameter value set 3: Value of parameter 18 (Param. set 3: Set3: value 18) -2147483648 ... [0] ... 2147483647	
0x4044:019 (PAR 753/019)	Parameter value set 3: Value of parameter 19 (Param. set 3: Set3: value 19) -2147483648 ... [0] ... 2147483647	
0x4044:020 (PAR 753/020)	Parameter value set 3: Value of parameter 20 (Param. set 3: Set3: value 20) -2147483648 ... [0] ... 2147483647	
0x4044:021 (PAR 753/021)	Parameter value set 3: Value of parameter 21 (Param. set 3: Set3: value 21) -2147483648 ... [0] ... 2147483647	
0x4044:022 (PAR 753/022)	Parameter value set 3: Value of parameter 22 (Param. set 3: Set3: value 22) -2147483648 ... [0] ... 2147483647	
0x4044:023 (PAR 753/023)	Parameter value set 3: Value of parameter 23 (Param. set 3: Set3: value 23) -2147483648 ... [0] ... 2147483647	
0x4044:024 (PAR 753/024)	Parameter value set 3: Value of parameter 24 (Param. set 3: Set3: value 24) -2147483648 ... [0] ... 2147483647	
0x4044:025 (PAR 753/025)	Parameter value set 3: Value of parameter 25 (Param. set 3: Set3: value 25) -2147483648 ... [0] ... 2147483647	
0x4044:026 (PAR 753/026)	Parameter value set 3: Value of parameter 26 (Param. set 3: Set3: value 26) -2147483648 ... [0] ... 2147483647	

Additional functions

Parameter change-over



Parameter	Name / value range / [default setting]	Info
0x4044:027 (PAR 753/027)	Parameter value set 3: Value of parameter 27 (Param. set 3: Set3: value 27) -2147483648 ... [0] ... 2147483647	
0x4044:028 (PAR 753/028)	Parameter value set 3: Value of parameter 28 (Param. set 3: Set3: value 28) -2147483648 ... [0] ... 2147483647	
0x4044:029 (PAR 753/029)	Parameter value set 3: Value of parameter 29 (Param. set 3: Set3: value 29) -2147483648 ... [0] ... 2147483647	
0x4044:030 (PAR 753/030)	Parameter value set 3: Value of parameter 30 (Param. set 3: Set3: value 30) -2147483648 ... [0] ... 2147483647	
0x4044:031 (PAR 753/031)	Parameter value set 3: Value of parameter 31 (Param. set 3: Set3: value 31) -2147483648 ... [0] ... 2147483647	
0x4044:032 (PAR 753/032)	Parameter value set 3: Value of parameter 32 (Param. set 3: Set3: value 32) -2147483648 ... [0] ... 2147483647	
0x4045:001 (PAR 754/001)	Parameter value set 4: Value of parameter 1 (Param. set 4: Set4: value 1) -2147483648 ... [0] ... 2147483647	Value set 4 for the parameter list defined in 0x4041:001 (PAR 750/001).
0x4045:002 (PAR 754/002)	Parameter value set 4: Value of parameter 2 (Param. set 4: Set4: value 2) -2147483648 ... [0] ... 2147483647	
0x4045:003 (PAR 754/003)	Parameter value set 4: Value of parameter 3 (Param. set 4: Set4: value 3) -2147483648 ... [0] ... 2147483647	
0x4045:004 (PAR 754/004)	Parameter value set 4: Value of parameter 4 (Param. set 4: Set4: value 4) -2147483648 ... [0] ... 2147483647	
0x4045:005 (PAR 754/005)	Parameter value set 4: Value of parameter 5 (Param. set 4: Set4: value 5) -2147483648 ... [0] ... 2147483647	
0x4045:006 (PAR 754/006)	Parameter value set 4: Value of parameter 6 (Param. set 4: Set4: value 6) -2147483648 ... [0] ... 2147483647	
0x4045:007 (PAR 754/007)	Parameter value set 4: Value of parameter 7 (Param. set 4: Set4: value 7) -2147483648 ... [0] ... 2147483647	
0x4045:008 (PAR 754/008)	Parameter value set 4: Value of parameter 8 (Param. set 4: Set4: value 8) -2147483648 ... [0] ... 2147483647	
0x4045:009 (PAR 754/009)	Parameter value set 4: Value of parameter 9 (Param. set 4: Set4: value 9) -2147483648 ... [0] ... 2147483647	
0x4045:010 (PAR 754/010)	Parameter value set 4: Value of parameter 10 (Param. set 4: Set4: value 10) -2147483648 ... [0] ... 2147483647	
0x4045:011 (PAR 754/011)	Parameter value set 4: Value of parameter 11 (Param. set 4: Set4: value 11) -2147483648 ... [0] ... 2147483647	
0x4045:012 (PAR 754/012)	Parameter value set 4: Value of parameter 12 (Param. set 4: Set4: value 12) -2147483648 ... [0] ... 2147483647	
0x4045:013 (PAR 754/013)	Parameter value set 4: Value of parameter 13 (Param. set 4: Set4: value 13) -2147483648 ... [0] ... 2147483647	
0x4045:014 (PAR 754/014)	Parameter value set 4: Value of parameter 14 (Param. set 4: Set4: value 14) -2147483648 ... [0] ... 2147483647	
0x4045:015 (PAR 754/015)	Parameter value set 4: Value of parameter 15 (Param. set 4: Set4: value 15) -2147483648 ... [0] ... 2147483647	



Additional functions

Parameter change-over

Parameter	Name / value range / [default setting]	Info
0x4045:016 (PAR 754/016)	Parameter value set 4: Value of parameter 16 (Param. set 4: Set4: value 16) -2147483648 ... [0] ... 2147483647	
0x4045:017 (PAR 754/017)	Parameter value set 4: Value of parameter 17 (Param. set 4: Set4: value 17) -2147483648 ... [0] ... 2147483647	
0x4045:018 (PAR 754/018)	Parameter value set 4: Value of parameter 18 (Param. set 4: Set4: value 18) -2147483648 ... [0] ... 2147483647	
0x4045:019 (PAR 754/019)	Parameter value set 4: Value of parameter 19 (Param. set 4: Set4: value 19) -2147483648 ... [0] ... 2147483647	
0x4045:020 (PAR 754/020)	Parameter value set 4: Value of parameter 20 (Param. set 4: Set4: value 20) -2147483648 ... [0] ... 2147483647	
0x4045:021 (PAR 754/021)	Parameter value set 4: Value of parameter 21 (Param. set 4: Set4: value 21) -2147483648 ... [0] ... 2147483647	
0x4045:022 (PAR 754/022)	Parameter value set 4: Value of parameter 22 (Param. set 4: Set4: value 22) -2147483648 ... [0] ... 2147483647	
0x4045:023 (PAR 754/023)	Parameter value set 4: Value of parameter 23 (Param. set 4: Set4: value 23) -2147483648 ... [0] ... 2147483647	
0x4045:024 (PAR 754/024)	Parameter value set 4: Value of parameter 24 (Param. set 4: Set4: value 24) -2147483648 ... [0] ... 2147483647	
0x4045:025 (PAR 754/025)	Parameter value set 4: Value of parameter 25 (Param. set 4: Set4: value 25) -2147483648 ... [0] ... 2147483647	
0x4045:026 (PAR 754/026)	Parameter value set 4: Value of parameter 26 (Param. set 4: Set4: value 26) -2147483648 ... [0] ... 2147483647	
0x4045:027 (PAR 754/027)	Parameter value set 4: Value of parameter 27 (Param. set 4: Set4: value 27) -2147483648 ... [0] ... 2147483647	
0x4045:028 (PAR 754/028)	Parameter value set 4: Value of parameter 28 (Param. set 4: Set4: value 28) -2147483648 ... [0] ... 2147483647	
0x4045:029 (PAR 754/029)	Parameter value set 4: Value of parameter 29 (Param. set 4: Set4: value 29) -2147483648 ... [0] ... 2147483647	
0x4045:030 (PAR 754/030)	Parameter value set 4: Value of parameter 30 (Param. set 4: Set4: value 30) -2147483648 ... [0] ... 2147483647	
0x4045:031 (PAR 754/031)	Parameter value set 4: Value of parameter 31 (Param. set 4: Set4: value 31) -2147483648 ... [0] ... 2147483647	
0x4045:032 (PAR 754/032)	Parameter value set 4: Value of parameter 32 (Param. set 4: Set4: value 32) -2147483648 ... [0] ... 2147483647	

Additional functions

Parameter change-over



Parameter	Name / value range / [default setting]	Info
0x4046 (PAR 755)	Activation of parameter set (Param. set mode)	Selection of the activation method for the parameter change-over.
	0 Via command (only if the controller is inhibited)	The parameter set selected via the "Parameter set selection bit 0" and "Parameter set selection bit 1" functions is activated if the trigger assigned in 0x2631:040 (PAR 400/040) of the "Load parameter set" function supplies a FALSE-TRUE edge AND the inverter is inhibited.
	1 Via command (immediately)	The parameter set selected via the "Parameter set selection bit 0" and "Parameter set selection bit 1" functions is activated if the trigger assigned in 0x2631:040 (PAR 400/040) of the "Load parameter set" function supplies a FALSE-TRUE edge.
	2 If the selection is changed (only if the controller is inhibited)	The parameter set selected via the "Parameter set selection bit 0" and "Parameter set selection bit 1" functions is activated if a state change of these selection bits takes place AND the inverter is inhibited.
	3 If the selection is changed (immediately)	The parameter set selected via the "Parameter set selection bit 0" and "Parameter set selection bit 1" functions is activated if a state change of these selection bits takes place.
0x4047:001 (PAR 756/001)	Parameter change-over error message: Status (Param. set status: Param. set error)	Error message for the "Parameter set changeover" function. <ul style="list-style-type: none"> In the event of an error, an error status is shown here, and in 0x4047:002 (PAR 756/002) the number of the list entry in which the error has occurred is displayed (in connection with the value set selected). If several errors occur at the same time, only the first incorrect list entry will be displayed. Hence, after elimination of the displayed error and repeated activation, more errors may be displayed. The parameter list will always be processed from beginning to end, even if errors occur in the meantime.
	0 No fault	
	33803 Invalid data type	
	33804 Range violation	
	33806 Invalid index	
	33813 No element selected	
	33815 Writing impermissible	
	33816 Device not inhibited	
	33829 Invalid subindex	
	33837 Access impermissible	
33865 No subindexes		
0x4047:002 (PAR 756/002)	Parameter change-over error message: List entry (Param. set status: ParSet error loc)	Error message for the "Parameter set changeover" function. <ul style="list-style-type: none"> In the event of an error, the number of the list entry for which the error displayed in 0x4047:001 (PAR 756/001) has occurred is shown here.
	• Read only	
0x2631:040 (PAR 400/040)	Function assignment: Load parameter set (Function list: Load param.set)	Assignment of a trigger for the "Load parameter set" function. Trigger = FALSE-TRUE edge: parameter change-over to the value set selected via "Parameter set selection bit 0" and "Parameter set selection bit 1". Trigger = FALSE: no action. Notes: <ul style="list-style-type: none"> The activation method for the "Parameter change-over" function can be selected in 0x4046 (PAR 755).
	• Setting can only be changed if controller inhibit is active. • For possible settings see description for 0x2631:001 (PAR 400/001). 188	
	00 Not connected	No trigger assigned (trigger is constantly FALSE).
0x2631:041 (PAR 400/041)	Function assignment: Parameter set selection bit 0 (Function list: Par.set selection b0)	Assignment of a trigger for the "Parameter set selection bit 0" function. Selection bit with the valency 2 ⁰ for "Parameter change-over" function. Trigger = FALSE: selection bit = "0". Trigger = TRUE: selection bit = "1".
	• Setting can only be changed if controller inhibit is active. • For possible settings see description for 0x2631:001 (PAR 400/001). 188	
	00 Not connected	No trigger assigned (trigger is constantly FALSE).
0x2631:042 (PAR 400/042)	Function assignment: Parameter set selection bit 1 (Function list: Par.set selection b1)	Assignment of a trigger for the "Parameter set selection bit 1" function. Selection bit with the valency 2 ¹ for "Parameter change-over" function. Trigger = FALSE: selection bit = "0". Trigger = TRUE: selection bit = "1".
	• Setting can only be changed if controller inhibit is active. • For possible settings see description for 0x2631:001 (PAR 400/001). 188	
	00 Not connected	No trigger assigned (trigger is constantly FALSE).



10.9 Device profile CiA402

The CiA 402 device profile defines the functional behaviour of stepping motors, servo drives, and frequency inverters. In order to be able to describe the different drive types, various operating modes and device parameters are specified in the device profile. Each operating mode provides objects (e.g. for the setpoint speed, acceleration and deceleration) to generate the desired drive behaviour.

Parameter	Name / value range / [default setting]	Info
0x6042 (PAR 781)	Target velocity (Setp. speed vl) -32768 ... [0] ... 32767 rpm	Setpoint speed (velocity mode).
0x6043 (PAR 782)	Velocity demand (Speed interpol) • Read only: x rpm	Display of the interpolated setpoint speed (velocity mode).
0x6044 (PAR 783)	Velocity actual value (Actual speed) • Read only: x rpm	Display of the actual speed (velocity mode).
0x6046:001 (PAR 784/001)	Velocity min max amount: Velocity min amount (Min/max speed: VL min amount) 0 ... [0] ... 480000 rpm	Minimum speed (velocity mode).
0x6046:002 (PAR 784/002)	Velocity min max amount: Velocity max amount (Min/max speed: VL max amount) 0 ... [480000] ... 480000 rpm	Maximum speed (velocity mode).
0x6048:001 (PAR 785/001)	Velocity acceleration: Delta speed (Speed acc.: Delta speed) 0 ... [3000] ... 2147483647 rpm	Acceleration: speed interval
0x6048:002 (PAR 785/002)	Velocity acceleration: Delta time (Speed acc.: Delta time) 0 ... [10] ... 65535 s	Acceleration: time interval
0x6049:001 (PAR 786/001)	Velocity deceleration: Delta speed (Speed decel.: Delta speed) 0 ... [3000] ... 2147483647 rpm	Deceleration: speed interval
0x6049:002 (PAR 786/002)	Velocity deceleration: Delta time (Speed decel.: Delta time) 0 ... [10] ... 65535 s	Deceleration: time interval
0x605A	Quick stop option code	Device status after exiting the quick stop ramp.
	2 Quick stop ramp -> switch-on inhibited 6 Quick stop ramp -> quick stop active	Automatic change to the "Switch-on inhibited" device state. The inverter remains in the "Quick stop active" device state.
0x605E (PAR 791)	Fault reaction option code (Resp. in the event of error)	Selection of the response to faults.
	-2 DC braking 0 Coasting	The motor coasts down to standstill.
	2 Quick Stop	
0x6060 (PAR 301)	Modes of operation (Modes of op.) • Setting can only be changed if controller inhibit is active.	Selection of the operating mode.
	-2 Lenze speed mode	
	0 Mode not changed or assigned 2 Velocity mode	No operating mode (standstill).
0x6061 (PAR 788)	Modes of operation display (Modes of op. dis) • Read only	Display of the current operating mode.
	-11 Lenze identification -10 Lenze test mode -2 Lenze speed mode	
	0 Mode not changed or assigned 2 Velocity mode	No operating mode (standstill).
0x6071	Target torque -3276.8 ... [0.0] ... 3276.7 %	Setpoint torque • 100 % ≙ Motor rated torque 0x6076 (PAR 325)

Additional functions

Device profile CiA402



Parameter	Name / value range / [default setting]	Info
0x6074	Torque demand value • Read only: x.x %	Display of the interpolated setpoint torque. • 100 % \equiv Motor rated torque 0x6076 (PAR 325)
0x6079	DC link circuit voltage • Read only: x.xxx V	Display of the current DC-bus voltage.
0x6085 (PAR 790)	Quick stop deceleration (<i>402quickst time</i>) 0 ... [546000] ... 2147483647 pos. unit / s ²	Change in velocity used for deceleration to a standstill if quick stop is activated. • Setting only applies to CiA402 velocity mode. • For Lenze velocity mode, the deceleration time set in 0x291C (PAR 225) is effective. 0x6085 = ((initial speed of the motor [rpm]) / (duration of the ramp until standstill [s])) * 1092
0x6502 (PAR 789)	Supported drive modes (<i>Supported modes</i>) • Read only	Bit-coded display of the operating modes supported.
Bit 0	Not specified	Bit is not supported.
Bit 1	Velocity mode	
Bit 2	Not specified	Bit is not supported.
Bit 3		
Bit 4	Reserved	-
Bit 5	Not specified	Bit is not supported.
Bit 6		
Bit 7	Cyclic synchronous position mode	
Bit 8	Cyclic synchronous velocity mode	
Bit 9	Cyclic synchronous torque mode	
Bit 10	Reserved	-
Bit 11		
Bit 12		
Bit 13		
Bit 14		
Bit 15		
Bit 16		
Bit 17	Lenze speed mode	
Bit 18	Reserved	-
Bit 19		
Bit 20		
Bit 21		
Bit 22		
Bit 23		
Bit 24		
Bit 25		
Bit 26		
Bit 27		
Bit 28		
Bit 29		
Bit 30		
Bit 31		
0x6040	Controlword 0 ... [0] ... 65535	Mappable CiA402 control word with bit assignment in compliance with CiA402 device profile.
Bit 0	Switch on	
Bit 1	Enable voltage	
Bit 2	Quick stop	
Bit 3	Enable operation	
Bit 4	Operation mode specific	
Bit 5		
Bit 6		
Bit 7	Fault reset	
Bit 8	n/a	Bit is not supported.



Additional functions

Device profile CiA402

Parameter	Name / value range / [default setting]	Info
	Bit 9 Operation mode specific	
	Bit 10 Reserved	
	Bit 11 Override coast	
	Bit 12 Autolnit	
	Bit 13 Reserved	
	Bit 14 Release holding brake	
	Bit 15 Reserved	
0x6041 (PAR 780)	Statusword (<i>Statusword</i>) • Read only	Mappable CiA402 status word with bit assignment in compliance with CiA402 device profile.
	Bit 0 Ready to switch on	
	Bit 1 Switched on	
	Bit 2 Operation enabled	
	Bit 3 Fault active	
	Bit 4 Voltage enabled	
	Bit 5 Quick stop	
	Bit 6 Switch on disabled	
	Bit 7 Warning active	
	Bit 8 Deactivate RPDOs	1 ≡ cyclic PDOs have been deactivated.
	Bit 9 Remote	1 ≡ inverter can receive commands via network.
	Bit 10 Target reached	1 ≡ the actual position is in the window.
	Bit 11 Internal limit active	1 ≡ internal limitation of a setpoint active.
	Bit 12 Operation mode active	
	Bit 13 Following error	
	Bit 14 Holding brake released	
	Bit 15 Safe torque off (STO) not active	

Additional functions

Holding brake control



10.10 Holding brake control

This function is used for low-wear control of a holding brake.

Preconditions

- Observe that the holding brake is an important element of the machine's safety concept as a whole. Therefore be sure to carry out commissioning of this system part with particular care!
- Holding brakes on Lenze motors are not intended for braking during operation. The increased wear caused by braking during operation may destroy the holding brake prematurely!
- Ensure that the inverter builds up a sufficient torque in the motor when releasing and applying the holding brake, in order to hold the load. For this purpose, a voltage boost can for instance be set for the V/f characteristic control. ▶ [Voltage boost](#) □ 84
- If the holding brake is to be controlled via a digital output, the use of an additional relay or power contactor is required. The digital output is not suited for direct control of a holding brake.
- When a power contactor is used, the response time and release time of the contactor is added to the engagement and disengagement time of the holding brake. Both times must also be taken into consideration for parameterising the engagement and disengagement time of the holding brake.
- If, instead of an electrically releasing (self-holding) holding brake, an electrically holding (self-releasing) holding brake is to be controlled, a signal inversion for the digital output used or for the relay is to be set! ▶ [Configuration of digital outputs](#) □ 215
- If a switch-on delay is required, it has to be set for the digital output used or for the relay! ▶ [Configuration of digital outputs](#) □ 215

Details

Holding brakes are used for locking axes with controller inhibit or pulse inhibit, or if the system is in the "mains off" state. This is not only important for vertical axes but, for instance, also for horizontal axes which may cause various problems with uncontrolled movements.

Examples:

- Loss of the reference information after mains OFF and further spinning of the drive.
- Collision with other moving machine parts.

The holding brake can either be released automatically when the controller is enabled or manually via a control signal. The holding brake control itself only outputs a digital trigger for releasing the holding brake. This trigger can be assigned to a digital output or, in the easiest case, to the relay which then switches the brake supply.

Parameter	Name / value range / [default setting]	Info
0x2820:001 (PAR 712/001)	Holding brake control: Operating mode (Mech. brake: MB operating mode)	Selection of the operating mode for the holding brake control.
	0 Automatically (via device state)	The "Release holding brake" command is effected automatically when the inverter is in the "Controller enable" state.
	1 Manually	The "Release holding brake" command is activated by an external trigger: <ul style="list-style-type: none"> • Via bit 14 in the CiA402 control word 0x6040. • Via the trigger assigned in 0x2631:049 (PAR 400/049) of the "Release holding brake" function.
	2 No braking function	During normal operation, brakes are neither controlled, nor detected, nor monitored.
0x2820:002 (PAR 712/002)	Holding brake control: Engagement time (Mech. brake: Engagement time) 0 ... [100] ... 10000 ms	Engagement time (application time) of the holding brake.
0x2820:003 (PAR 712/003)	Holding brake control: Disengagement time (Mech. brake: Disengagem. time) 0 ... [100] ... 10000 ms	Disengagement time (release time) of the holding brake.



Additional functions

Holding brake control

Parameter	Name / value range / [default setting]	Info
0x2820:007 (PAR 712/007)	Holding brake control: Application threshold (Mech. brake: MB application level) 0.0 ... [0.2] ... 599.0 Hz	Threshold for applying the holding brake for automatic mode without feedforward control (typically for horizontal applications). <ul style="list-style-type: none"> Only effective if the holding load in 0x2820:008 (PAR 712/008) is set to 0 %. By setting a threshold, the holding brake can be triggered to close before the output frequency has reached the value 0 Hz. In order that the brake can work correctly, the threshold for closing the brake must be set to a value that is greater than or that equals the minimum frequency 0x2915 (PAR 210).
0x2820:008 (PAR 712/008)	Holding brake control: Holding load (Mech. brake: MB holding load) -500.0 ... [0.0] ... 500.0 %	Holding load for automatic mode (typically for vertical applications). <ul style="list-style-type: none"> 100 % ≡ slip frequency 0x2C02:004 (PAR 351/004) For vertical applications we recommend starting with the setting 100 % and then reducing the setting value, if required.
0x2820:015 (PAR 712/015)	Holding brake control: Brake status (Mech. brake: MB status) <ul style="list-style-type: none"> Read only 	Display of the holding brake status.
	0 Active	
	1 Brake released	
0x2631:049 (PAR 400/049)	Function assignment: Release holding brake (Function list: Release brake) <ul style="list-style-type: none"> Setting can only be changed if controller inhibit is active. For possible settings see description for 0x2631:001 (PAR 400/001). 188 	Assignment of a trigger for the "Release holding brake" function. Trigger = TRUE: release holding brake in manual mode. Trigger = FALSE: no action. Notes: <ul style="list-style-type: none"> Function is only executed if the operating mode of the holding brake in 0x2820:001 (PAR 712/001) is set to "Manual [1]".
	00 Not connected	No trigger assigned (trigger is constantly FALSE).

Additional functions

Flying restart function



10.11 Flying restart function

This function makes it possible to restart a coasting motor on the fly during operation without speed feedback. Synchronicity between the inverter and the motor is coordinated so that the transition to the rotating drive is effected without jerk at the time of connection.

Preconditions

- The "Flying restart process" function is only suitable for asynchronous motors.
- The "Flying restart process" function is only used if selection 2 is set as starting performance in [0x2838:001 \(PAR 203/001\)](#).

Details

The function works with a simple motor model requiring knowledge of the motor stator resistance and the rated motor current. The inverter determines synchronicity by identifying the synchronous field frequency. The "Flying restart process" is completed within approx. 0.5 ... 1.5 seconds. The duration is influenced by the start frequency [0x2BA1:001 \(PAR 718/001\)](#). If the field frequency is not known, a fixed start frequency of 10 Hz (or -10 Hz for systems rotating in the negative direction) is recommended.

Parameter	Name / value range / [default setting]	Info
0x2BA1:001 (PAR 718/001)	Flying restart circuit: Current (Flying restart circuit: Flying restart current) 0 ... [30] ... 100 %	Current that is injected into the motor during the flying restart process for the identification of the speed. <ul style="list-style-type: none">• Reducing the current causes a reduction of the motor torque during the flying restart process. A short-time starting action or reversing of the motor is prevented with low flying restart currents.• If the current is increased, this improves the robustness of the flying restart function.
0x2BA1:002 (PAR 718/002)	Flying restart circuit: Start frequency (Flying restart circuit: Start frequency) -599.0 ... [20.0] ... 599.0 Hz	Restart frequency for flying restart process.
0x2BA1:003 (PAR 718/003)	Flying restart circuit: Restart time (Flying restart circuit: Flying restart time) 1 ... [5911]* ... 60000 ms <ul style="list-style-type: none">• Default setting depending on the size.	Restart time for flying restart process. <ul style="list-style-type: none">• The duration of the flying restart process can be influenced by the setting of the restart time.• A reduction of the restart time causes an accelerated flying restart process and therefore a reduced flying restart duration.
0x2BA1:008 (PAR 718/008)	Flying restart circuit: Flying restart frequency (Flying restart circuit: Flying restart frequency) <ul style="list-style-type: none">• Read only: x.x Hz	



10.12 Fault configuration

Configuration of the restart behaviour after a fault.



The fault configuration has no impact on errors and warnings of the inverter.

Parameter	Name / value range / [default setting]	Info
0x2826	Time-out for error response 0.0 ... [6.0] ... 100.0 s	This timer is started when a change-over to the "Error response active" device state takes place. If no motor standstill is detected after this time-out has elapsed, or the motor is still rotating, a change-over to the "Error" device state takes place. Note: If the "coast to stop forced" bit is set when the error has occurred, an immediate change-over to the "Error" device state takes place.
0x2839:002 (PAR 760/002)	Fault configuration: Restart delay (Fault config.: Ctrl: start-up del) 0.0 ... [3.0] ... 1000.0 s	If a fault occurs, a restart is possible at the earliest after the time set here has elapsed.
0x2839:003 (PAR 760/003)	Fault configuration: Number of restart attempts (Fault config.: Ctrl: start-up counter) 0 ... [5] ... 255	Number of restart attempts after a fault. Note! With a setting > 1, automatic restart of the motor is possible after a fault (e.g. device overload)!
0x2839:004 (PAR 760/004)	Fault configuration: Down-counting time of glitch counter (Fault config.: Ctrl: dec. period) 0.1 ... [5.0] ... 3600.0 s	Time of trouble-free operation after the expiry of which the fault counter is decreased by 1.
0x2839:005 (PAR 760/005)	Fault configuration: Current counter content of glitch counter (Fault config.: Ctrl: curr. counter) • Read only	Display of the current fault counter content. • The counter content is increased by 1 after each restart attempt.

Additional functions

Parameter for engineering tools



10.13 Parameter for engineering tools

The following parameters are required for an interaction of the engineering tools with the inverter connected online.

Parameter	Name / value range / [default setting]	Info	
0x2022:032	Device commands: Deactivate PDO Communication	1 = deactivate PDO communication.	
	0 Off / ready	Only status feedback.	
	1 On / start	Execute device command.	
	2 In progress	Only status feedback.	
	3 Action cancelled		
	4 No access		
	5 No access (controller inhibit)		
0x2022:033	Device commands: Activate PDO Communication	1 = activate PDO communication.	
	0 Off / ready	Only status feedback.	
	1 On / start	Execute device command.	
	2 In progress	Only status feedback.	
	3 Action cancelled		
	4 No access		
	5 No access (controller inhibit)		
0x2822:001	Axis commands: Enable inverter	1 = enable inverter.	
	0 Controller inhibited	<ul style="list-style-type: none"> In 0x2823:002, a status information for the axis command is displayed. 	
	1 Controller enabled		
0x2822:002	Axis commands: Activate quick stop 0 ... [0] ... 1	1 = activate quick stop. <ul style="list-style-type: none"> In 0x2823:002, a status information for the axis command is displayed. 	
0x2822:003	Axis commands: Reset error 0 ... [0] ... 1	1 = reset error. <ul style="list-style-type: none"> In 0x2823:002, a status information for the axis command is displayed. 	
0x2823:001	Last subindex <ul style="list-style-type: none"> Read only 		
0x2823:002	Status of last axis command <ul style="list-style-type: none"> Read only 	Status information on the axis command executed last.	
	0 Successful		
	1 Unknown command		
	2 No access		
	3 Time-out		
	4 Error		
	5 Command server assigned		
	6 Controller inhibit required		
	7 Controller enable required		
	8 Command is executed		
	10 Memory module link invalid		
	11 Password too short		
	12 Wrong password		
	13 Password set		
	14 Password assigned		
0x2832	Motor identification status <ul style="list-style-type: none"> Read only 	Bit coded display of the status of the motor parameter identification.	
	Bit 0 Identification enabled		
	Bit 1 Identification active		
	Bit 2 Identification completed		
	Bit 3 Identification failed		
	Bit 4 Reserved		-
	Bit 5		
	Bit 6		
	Bit 7		
	Bit 8		



Additional functions

Parameter for engineering tools

Parameter	Name / value range / [default setting]	Info
	Bit 9 Bit 10 Bit 11 Bit 12 Bit 13 Bit 14 Bit 15	
0x2EFF:001	Bootloader activation key 1 0 ... [0] ... 4294967295 • Setting can only be changed if controller inhibit is active.	
0x2EFF:002	Bootloader activation key 2 0 ... [0] ... 4294967295 • Setting can only be changed if controller inhibit is active.	
0x2EFF:003	Bootloader activation key 3 0 ... [0] ... 4294967295 • Setting can only be changed if controller inhibit is active.	



11 Flexible I/O configuration

Use parameter 0x2631 (*PAR 400*) to individually adapt the inverter control to the respective application. This is basically effected by assigning digital control sources ("triggers") to functions of the inverter.

⚠ DANGER!

Do not assign a digital input to several functions!

Possible consequence: unforeseeable behaviour of the drive

- ▶ Ensure that a digital input is always only assigned to one function.

Details

- Each subcode of 0x2631 (*PAR 400*) is permanently assigned to a specific function. Functions are for example "Controller enable", "Quick stop" or "Forward start (CW)".
- For a function, exactly one (digital) trigger can be set:



- Possible triggers to be selected are for example the digital input and internal status signals of the inverter.
- A list of all triggers available can be found in the description for the parameter [0x2631:001 \(PAR 400/001\)](#).
- If the trigger condition is met, the corresponding function is executed. More details with regard to the respective trigger conditions can be gathered from the functional descriptions in the following subchapters.
- If certain assignment guidelines are not complied with (depending on whether the keypad control or terminal mode has been selected), a corresponding error message is output.

Example: changing the function assignment of a digital input

In order to, for example, cancel the default assignment of digital input 4 to the "Reversal" function and to assign digital input 4 to the "DC braking" function instead, the following two settings are required:

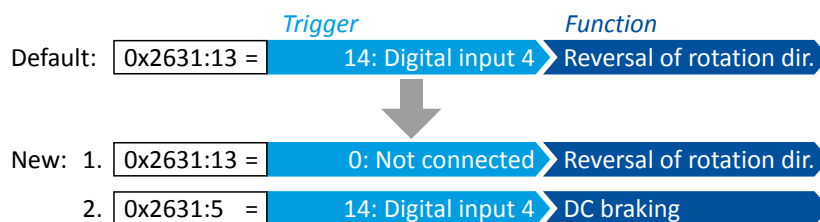



11.1 Control source change-over

The term "control sources" in this connection refers to the signal sources from which the inverter receives its start, stop, and reversal commands.



Possible control sources are:

- Digital inputs
- Process input data (network)
- Keypad keys

Details

If flexible control is set in [0x2824 \(PAR 200\)](#), a change-over from one control source to another can be effected during operation using corresponding functions. The inverter not only supports such a change-over via its digital inputs, but also as a function of internal inverter states.

In order to deactivate the digital inputs as control source and use the keypad or network as control source instead:



- By means of the "Keypad control" ([0x2631:012 \(PAR 400/012\)](#)) function, the keypad can be activated as control source. The drive can then be started and stopped via the  and  keypad keys.
- The "Network enable" ([0x2631:037 \(PAR 400/037\)](#)) function serves to activate the network control mode. The inverter then responds to the start and stop commands received via network.

Inverter behaviour when the control source is changed

If, during change-over of the control source, a function with a level-sensitive trigger is active (e.g. Quick stop" or "DC braking"), the inverter responds to the new trigger state for the respective function immediately when the control source is changed over.

If a function with an edge-sensitive trigger is active instead (e.g. Forward start (CW)", "Backward start (CCW)"), this function remains active after change-over until another function is activated by the new control source.



If the  keypad key is pressed, this state is saved internally. Restarting the drive from another control source therefore requires pressing the  key first in order to cancel the stop command by the keypad again.

Parameter	Name / value range / [default setting]	Info
0x2631:012 (PAR 400/012)	Function assignment: Keypad control (Function list: Keypad control) • For possible settings see description for 0x2631:001 (PAR 400/001) . 188	Assignment of a trigger for the "Keypad control" function. Trigger = TRUE: activate keypad as control source. Trigger = FALSE: no action / deactivate keypad as control source again.
	00 Not connected	No trigger assigned (trigger is constantly FALSE).
0x2631:037 (PAR 400/037)	Function assignment: Network enable (Function list: Network enable) • For possible settings see description for 0x2631:001 (PAR 400/001) . 188	Assignment of a trigger for the "Network enable" function. Trigger = TRUE: activate network control mode. Trigger = FALSE: no action / deactivate network control mode again.
	00 Not connected	No trigger assigned (trigger is constantly FALSE).
0x2824 (PAR 200)	Control selection (Control source)	Selection of the type of inverter control.
	0 Terminal mode (flexible I/O configuration)	This selection enables a flexible assignment of the start, stop, and rotating direction commands with digital signal sources (e.g. digital inputs, process data received via network).
	1 Keypad	This selection enables starting and stopping of the inverter exclusively via the start and stop key of the keypad. • Other signal sources for starting the inverter are ignored. • This selection is advisable for an initial functional test if no external control sources are connected yet.

Flexible I/O configuration

Controller enable, starting & stopping, reversal



11.2 Controller enable, starting & stopping, reversal

Configuration of the triggers for the following basic functions for traversing the drive:

- Controller enable - enable/inhibit operation.
- Start enable - start drive / enable start functions.
- Quick stop - bring drive to a standstill in best time.
- Forward start (CW) / backward start (CCW) - start drive in edge-controlled fashion.
- Forward run (CW) / backward run (CCW) - start/stop drive in status-controlled fashion.
- Forward jog (CW) / backward jog (CCW) - traverse drive with preset setpoint.
- Change of direction of rotation

Preconditions

- The triggers for start and stop commands set in 0x2631 (PAR 400) are only effective if selection "0" (terminal mode) is set in [0x2824 \(PAR 200\)](#).
- In terminal mode, either the "Controller enable" function or the "Start enable" function must be connected to an input so that the drive can be stopped again anytime!

Parameter	Name / value range / [default setting]	Info
0x2631:001 (PAR 400/001)	Function assignment: Controller enable (Function list: Controller enable) <ul style="list-style-type: none"> • Setting can only be changed if controller inhibit is active. 	Assignment of a trigger for the "Controller enable" function. Trigger = TRUE: The inverter is enabled (unless there is another cause for controller inhibit). Trigger = FALSE: The inverter is inhibited. Starting the drive is not possible. Notes: <ul style="list-style-type: none"> • In all device states, a TRUE-FALSE edge causes an immediate change to the inhibited state with one exception: If the inverter is in the error status and the error condition still exists, the inverter remains in the error status. • Changing to the inhibited state causes an immediate stop of the drive, regardless of the stop method set in 0x2838:003 (PAR 203/003). The drive coasts down as a function of the mass inertia of the machine. • The causes that are active for controller inhibit are shown in 0x282A:001 (PAR 126/001).
	0 Not connected	No trigger assigned (trigger is constantly FALSE).
	1 Constant TRUE	Trigger is constantly TRUE.
	11 Digital input 1	State of X3/DI1, taking an inversion set in 0x2632:001 (PAR 411/001) into consideration.
	12 Digital input 2	State of X3/DI2, taking an inversion set in 0x2632:002 (PAR 411/002) into consideration.
	13 Digital input 3	State of X3/DI3, taking an inversion set in 0x2632:003 (PAR 411/003) into consideration.
	14 Digital input 4	State of X3/DI4, taking an inversion set in 0x2632:004 (PAR 411/004) into consideration.
	15 Digital input 5	State of X3/DI5, taking an inversion set in 0x2632:005 (PAR 411/005) into consideration.
	16 Digital input 6	State of X3/DI6, taking an inversion set in into consideration.
	17 Digital input 7	State of X3/DI7, taking an inversion set in into consideration.
	50 Running	TRUE if motor is controlled (pulse width modulation on). Otherwise FALSE.
	51 Ready for operation	TRUE if operation is enabled AND no error is active. Otherwise FALSE.
	53 Stop active	TRUE if inverter is not enabled OR Stop command is active and output frequency = 0. FALSE if inverter enabled OR quick stop active OR fault active OR output frequency ≠ 0.
	54 Quick stop active	TRUE if quick stop is active. Otherwise FALSE. <ul style="list-style-type: none"> • With the setting "Quick stop ramp -> switch-on inhibited" in 0x605A, the "Quick stop active" status is reset to FALSE after ramp-down to standstill. • With the setting "Quick stop ramp -> quick stop active" in 0x605A, the "quick stop active" status remains TRUE until the "quick stop" function is activated.



Flexible I/O configuration

Controller enable, starting & stopping, reversal

Parameter	Name / value range / [default setting]	Info
	58 Device warning active	TRUE if warning is active. Otherwise FALSE. <ul style="list-style-type: none"> A warning has no impact on the operating status of the inverter. A warning is reset automatically if the cause has been eliminated.
	59 Device fault active	TRUE if a fault is active. Otherwise FALSE. <ul style="list-style-type: none"> A fault deactivates control of the motor in the moment of its occurrence. A fault is reset automatically if the cause has been eliminated.
	60 Heatsink temperature warning active	TRUE if current heatsink temperature > warning threshold for temperature monitoring. Otherwise FALSE. <ul style="list-style-type: none"> Display of the current heatsink temperature in 0x2D84:001 (PAR 117/001). Setting of the warning threshold in 0x2D84:002.
	69 Reversal active	TRUE if reversal is active. Otherwise FALSE. <ul style="list-style-type: none"> Selection of the trigger for the "Reversal" function in 0x2631:013 (PAR 400/013).
	70 Frequency threshold exceeded	TRUE if current output frequency > frequency threshold. Otherwise FALSE. <ul style="list-style-type: none"> Display of the current output frequency in 0x2DDD (PAR 100). Setting Frequency threshold in 0x4005 (PAR 412). ▶ Frequency threshold for "Frequency threshold exceeded" trigger □ 209
	71 Actual speed = 0	TRUE if current output frequency = 0 Hz (± 0.01 Hz), irrespective of the operating mode. Otherwise FALSE. <ul style="list-style-type: none"> Display of the current output frequency in 0x2DDD (PAR 100).
	78 Current limit reached	TRUE if current motor current ≥ maximum current. Otherwise FALSE. <ul style="list-style-type: none"> Display of the present motor current in 0x2D88 (PAR 104). Setting for the maximum current in 0x6073 (PAR 324).
	80 Follower signal (4 ... 20 mA) lost	TRUE if follower signal (4 ... 20 mA) lower than 2 mA.
	81 Error of analog input 1	TRUE if error detection for analog input 1 has been activated. Otherwise FALSE. <p>The error detection function can be configured via the following parameters:</p> <ul style="list-style-type: none"> Monitoring threshold 0x2636:008 (PAR 430/008) Monitoring condition 0x2636:009 (PAR 430/009) Monitoring response 0x2636:010 (PAR 430/010) ▶ Analog input 1 □ 211
	82 Error of analog input 2	TRUE if error detection for analog input 2 has been activated. Otherwise FALSE. <p>The error detection function can be configured via the following parameters:</p> <ul style="list-style-type: none"> Monitoring threshold 0x2637:008 (PAR 431/008) Monitoring condition 0x2637:009 (PAR 431/009) Monitoring response 0x2637:010 (PAR 431/010) ▶ Analog input 2 □ 213
	83 Load loss	TRUE if current motor current < threshold for load loss detection for at least the delay for load loss detection. Otherwise FALSE. <ul style="list-style-type: none"> Display of the present motor current in 0x6078 (PAR 103). Setting Threshold in 0x4006:001 (PAR 710/001). Setting Deceleration in 0x4006:002 (PAR 710/002). ▶ Load loss detection □ 158
	104 Local control active	TRUE if local keypad control ("LOC") active. Otherwise FALSE.
	105 Remote control active	TRUE if remote control ("REM") via terminals, network, etc. active. Otherwise FALSE.
	106 Manual setpoint selection active	TRUE if manual setpoint selection ("MAN") via keypad active. Otherwise FALSE. <ul style="list-style-type: none"> Selection of the trigger for the "Setpoint = Keypad" function in 0x2631:016 (PAR 400/016).
	107 Automatic setpoint selection active	TRUE if automatic setpoint selection ("AUTO") via terminals, network, etc. active. Otherwise FALSE.

Flexible I/O configuration

Controller enable, starting & stopping, reversal



Parameter	Name / value range / [default setting]	Info
0x2631:002 (PAR 400/002)	Function assignment: Start enable (Function list: Start enable) <ul style="list-style-type: none"> Setting can only be changed if controller inhibit is active. For possible settings see description for 0x2631:001 (PAR 400/001). □ 188 	Assignment of a trigger for the "Start enable" function. Trigger = FALSE-TRUE edge: Drive is started in forward rotating direction (CW) if the following conditions are fulfilled: <ul style="list-style-type: none"> Controller is enabled and no error or quick stop are active. No other start command is configured (start-forwards/start-backwards/run-forwards/run-backwards = "Not connected [0]"). Trigger = TRUE-FALSE edge: drive is stopped again. Notes: <ul style="list-style-type: none"> If the controller enable is set = "Constant TRUE [1]", the only permissible trigger for this function is a digital input (otherwise the error message "Connected incorrectly" appears). The stop method can be selected in 0x2838:003 (PAR 203/003). The function also serves to realise an automatic start after switch-on. ▶ Starting performance □ 72
	11 Digital input 1	State of X3/DI1, taking an inversion set in 0x2632:001 (PAR 411/001) into consideration.
0x2631:003 (PAR 400/003)	Function assignment: Quick stop (Function list: Quick stop) <ul style="list-style-type: none"> Setting can only be changed if controller inhibit is active. For possible settings see description for 0x2631:001 (PAR 400/001). □ 188 	Assignment of a trigger for the "Quick stop" function. Trigger = TRUE: "Quick stop" function activated. Trigger = FALSE: no action / deactivate function again. Notes: <ul style="list-style-type: none"> The "Quick stop" function brings the motor to a standstill within the deceleration time set in 0x291C (PAR 225). The "Quick stop" function has a higher priority than the "Start enable" function.
	00 Not connected	No trigger assigned (trigger is constantly FALSE).
0x2631:006 (PAR 400/006)	Function assignment: Forward start (CW) (Function list: Forward start) <ul style="list-style-type: none"> Setting can only be changed if controller inhibit is active. For possible settings see description for 0x2631:001 (PAR 400/001). □ 188 	Assignment of a trigger for the "Forward start (CW)" function. Trigger = FALSE-TRUE edge: drive is started in forward rotating direction (CW). Trigger = FALSE: no action. Notes: <ul style="list-style-type: none"> In order to start the drive with this function, the "Start enable" function has to be assigned to a trigger in order to provide a stop command. After the start, the drive runs until the start enable is deactivated again or another stop command is given. In the case of a bipolar setpoint selection (e.g ± 10 V), the function is executed irrespective of the rotating direction. The rotating direction is determined by the sign of the setpoint. The "Reversal" function (0x2631:013 (PAR 400/013)) can be used in connection with this function. The use of the "Forward start (CW)" and "Backward start (CCW)" functions excludes the use of the "Forward run (CW)" and "Backward run (CCW)" and vice versa (produces a "Incorrectly connected" error message).
	00 Not connected	No trigger assigned (trigger is constantly FALSE).



Flexible I/O configuration

Controller enable, starting & stopping, reversal

Parameter	Name / value range / [default setting]	Info
0x2631:007 (PAR 400/007)	Function assignment: Backward start (CCW) (Function list: Backward start) <ul style="list-style-type: none"> Setting can only be changed if controller inhibit is active. For possible settings see description for 0x2631:001 (PAR 400/001). □ 188 	Assignment of a trigger for the "Backward start (CCW)" function Trigger = FALSE-TRUE edge: drive is started in backward rotating direction (CCW). Trigger = FALSE: no action. Notes: <ul style="list-style-type: none"> In order to start the drive with this function, the "Start enable" function has to be assigned to a trigger in order to provide a stop command. After the start, the drive runs until the start enable is deactivated again or another stop command is given. In the case of a bipolar setpoint selection (e.g. ± 10 V), the function is executed irrespective of the rotating direction. The rotating direction is determined by the sign of the setpoint. The "Reversal" function (0x2631:013 (PAR 400/013)) can be used in connection with this function. The use of the "Forward start (CW)" and "Backward start (CCW)" functions excludes the use of the "Forward run (CW)" and "Backward run (CCW)" and vice versa (produces a "Incorrectly connected" error message).
	00 Not connected	No trigger assigned (trigger is constantly FALSE).
0x2631:008 (PAR 400/008)	Function assignment: Forward run (CW) (Function list: Forward run) <ul style="list-style-type: none"> Setting can only be changed if controller inhibit is active. For possible settings see description for 0x2631:001 (PAR 400/001). □ 188 	Assignment of a trigger for the "Forward run (CW)" function. Trigger = TRUE: drive traverses in forward rotating direction (CW). Trigger = TRUE-FALSE edge: drive is stopped again. Notes: <ul style="list-style-type: none"> In order to start the drive with this function, the "Start enable" function has to be assigned to a trigger in order to provide a stop command. (If start enable is deactivated, the drive will be stopped as well.) The stop method can be selected in 0x2838:003 (PAR 203/003). In the case of a bipolar setpoint selection (e.g. ± 10 V), the function is executed irrespective of the rotating direction. The rotating direction is determined by the sign of the setpoint. The function also serves to realise an automatic start after switch-on. ▶ Starting performance □ 72 The "Reversal" function (0x2631:013 (PAR 400/013)) can be used in connection with this function. The use of the "Forward run (CW)" and "Backward run (CCW)" functions excludes the use of the "Forward start (CW)" and "Backward start (CCW)" functions and vice versa (produces a "Incorrectly connected" error message).
	00 Not connected	No trigger assigned (trigger is constantly FALSE).
0x2631:009 (PAR 400/009)	Function assignment: Backward run (CCW) (Function list: Backward run) <ul style="list-style-type: none"> Setting can only be changed if controller inhibit is active. For possible settings see description for 0x2631:001 (PAR 400/001). □ 188 	Assignment of a trigger for the "Backward run (CCW)" function. Trigger = TRUE: drive traverses in backward rotating direction (CCW). Trigger = TRUE-FALSE edge: drive is stopped again. Notes: <ul style="list-style-type: none"> In order to start the drive with this function, the "Start enable" function has to be assigned to a trigger in order to provide a stop command. (If start enable is deactivated, the drive will be stopped as well.) The stop method can be selected in 0x2838:003 (PAR 203/003). In the case of a bipolar setpoint selection (e.g. ± 10 V), the function is executed irrespective of the rotating direction. The rotating direction is determined by the sign of the setpoint. The function also serves to realise an automatic start after switch-on. ▶ Starting performance □ 72 The "Reversal" function (0x2631:013 (PAR 400/013)) can be used in connection with this function. The use of the "Forward run (CW)" and "Backward run (CCW)" functions excludes the use of the "Forward start (CW)" and "Backward start (CCW)" functions and vice versa (produces a "Incorrectly connected" error message).
	00 Not connected	No trigger assigned (trigger is constantly FALSE).

Flexible I/O configuration

Controller enable, starting & stopping, reversal

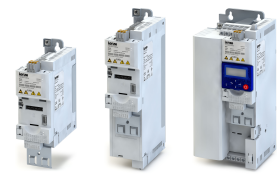

Parameter	Name / value range / [default setting]	Info
0x2631:010 (PAR 400/010)	Function assignment: Foward jog (CW) (Function list: Forward jog) <ul style="list-style-type: none"> Setting can only be changed if controller inhibit is active. For possible settings see description for 0x2631:001 (PAR 400/001). 188 	Assignment of a trigger for the "Foward jog (CW)" function. Trigger = TRUE: drive traverses in forward rotating direction (CW) with the preset value 5. Trigger = TRUE-FALSE edge: drive is stopped again. Notes: <ul style="list-style-type: none"> The preset value 5 can be set in 0x2911:005 (PAR 450/005). The stop method can be selected in 0x2838:003 (PAR 203/003). Jog operation has a higher priority than a stop command. If jog operation is active, a stop command that has been triggered has no effect! However, jog operation can be interrupted by the "Quick stop" function. Jog operation cannot be started automatically. The "Start at switch-on" option in 0x2838:002 (PAR 203/002) does not apply to jog operation. If "Foward jog (CW)" and "Backward jog (CCW)" are activated at the same time, the drive is stopped using the stop method and jog operation must be triggered again.
	00 Not connected	No trigger assigned (trigger is constantly FALSE).
0x2631:011 (PAR 400/011)	Function assignment: Backward jog (CCW) (Function list: Backward jog) <ul style="list-style-type: none"> Setting can only be changed if controller inhibit is active. For possible settings see description for 0x2631:001 (PAR 400/001). 188 	Assignment of a trigger for the "Backward jog (CCW)" function. Trigger = TRUE: drive traverses in backward rotating direction (CCW) with the preset value 6. Trigger = TRUE-FALSE edge: drive is stopped again. Notes: <ul style="list-style-type: none"> The preset value 6 can be set in 0x2911:006 (PAR 450/006). The stop method can be selected in 0x2838:003 (PAR 203/003). Jog operation has a higher priority than a stop command. If jog operation is active, a stop command that has been triggered has no effect! However, jog operation can be interrupted by the "Quick stop" function. Jog operation cannot be started automatically. The "Start at switch-on" option in 0x2838:002 (PAR 203/002) does not apply to jog operation. If "Foward jog (CW)" and "Backward jog (CCW)" are activated at the same time, the drive is stopped using the stop method and jog operation must be triggered again.
	00 Not connected	No trigger assigned (trigger is constantly FALSE).
0x2631:013 (PAR 400/013)	Function assignment: Reversal (Function list: Reversal of rot. dir.) <ul style="list-style-type: none"> Setting can only be changed if controller inhibit is active. For possible settings see description for 0x2631:001 (PAR 400/001). 188 	Assignment of a trigger for the "Reversal" function. Trigger = TRUE: the setpoint specified is inverted (i. e. the sign is inverted). Trigger = FALSE: no action / deactivate function again.
	13 Digital input 3	State of X3/DI3, taking an inversion set in 0x2632:003 (PAR 411/003) into consideration.



11.3 Setpoint change-over

Corresponding functions make it possible to change over to other setpoint sources during operation.

Possible setpoint sources are:

- Analog inputs
- Keypad
- Process input data (network)
- Parameterisable setpoints (preset values)
- "Motor potentiometer" function

Details

If no setpoint change-over function is active, the standard setpoint sources are active:

- [0x2860:001 \(PAR 201/001\)](#): frequency setpoint source
- [0x2860:002 \(PAR 201/002\)](#): process controller setpoint source

The setpoint source currently active is shown in [0x282B:002 \(PAR 125/002\)](#).

11.3.1 Priority of the setpoint sources

Since only one setpoint source can be active at a time, the following priorities apply:

1. Setpoint selection via network control word if the "Network enable" function is TRUE.
 - ▶ [0x2631:037 \(PAR 400/037\)](#) [□ 187](#)
2. Trigger for setpoint change-over (in the order of the selection list):
 1. 1: TRUE
 2. 11: digital input 1
 3. 12: digital input 2
 4. 13: digital input 3
 5. ...
3. Standard setpoint source set. ▶ [Selection of setpoint source](#) [□ 70](#)

Example of allocating priority

- Digital input 4 is assigned to the "Setpoint source = keypad" function as trigger.
- Digital input 5 is assigned to the "Setpoint source = analog input 1" function as trigger.

Digital input 4	Digital input 5	Active setpoint source
FALSE	FALSE	Standard setpoint source set in 0x2860:001 (PAR 201/001)
FALSE	TRUE	Analog input 1
TRUE	FALSE	Keypad
TRUE	TRUE	Keypad (since "Digital input 4" trigger has a higher priority than "Digital input 5" trigger)

11.3.2 Analog input setpoint source

The following functions are used to select analog input 1 or analog input 2 as setpoint source.

Preconditions

A setpoint change-over to the respective analog input is only effected if no setpoint source with a higher priority has been selected. ▶ [Priority of the setpoint sources](#) [□ 193](#)

Parameter	Name / value range / [default setting]	Info
0x2631:014 (PAR 400/014)	Function assignment: Setpoint = AI1 (Function list: Setpoint=AI1) • For possible settings see description for 0x2631:001 (PAR 400/001) . □ 188	Assignment of a trigger for the "Setpoint = AI1" function. Trigger = TRUE: analog input 1 is used as setpoint source (if the trigger assigned has the highest setpoint priority). Trigger = FALSE: no action / deactivate function again. ▶ Analog input 1 □ 211
	00 Not connected	No trigger assigned (trigger is constantly FALSE).
0x2631:015 (PAR 400/015)	Function assignment: Setpoint = AI2 (Function list: Setpoint=AI2) • For possible settings see description for 0x2631:001 (PAR 400/001) . □ 188	Assignment of a trigger for the "Setpoint = AI2" function. Trigger = TRUE: analog input 2 is used as setpoint source (if the trigger assigned has the highest setpoint priority). Trigger = FALSE: no action / deactivate function again. ▶ Analog input 2 □ 213
	00 Not connected	No trigger assigned (trigger is constantly FALSE).

Flexible I/O configuration

Setpoint change-over
Keypad setpoint source



11.3.3 Keypad setpoint source

The following function is used to select the keypad as setpoint source.

Preconditions

A setpoint change-over to the keypad is only effected if no setpoint source with a higher priority has been selected. ▶ [Priority of the setpoint sources](#) 193

Parameter	Name / value range / [default setting]	Info
0x2631:016 (PAR 400/016)	Function assignment: Setpoint = Keypad (Function list: Setpoint=Keypad) <ul style="list-style-type: none">For possible settings see description for 0x2631:001 (PAR 400/001). 188	Assignment of a trigger for the "Setpoint = Keypad" function. Trigger = TRUE: the keypad is used as setpoint source (if the trigger assigned has the highest setpoint priority). Trigger = FALSE: no action / deactivate function again. Notes: <ul style="list-style-type: none">The default keypad setpoint can be changed in keypad operating mode via the arrow keys of the keypad.
	00 Not connected	No trigger assigned (trigger is constantly FALSE).

11.3.4 Network setpoint source

Generally, the network can be optionally set as standard-setpoint source or, after corresponding configuration via a bit of the mappable NETWordIN1 data word, can be activated as setpoint source.

Preconditions

A setpoint change-over to the network is only effected if no setpoint source with a higher priority has been selected. ▶ [Priority of the setpoint sources](#) 193

Details

- In order to generally set the network as standard setpoint source, go to [0x2860:001 \(PAR 201/001\)](#) and set the selection "5: Network".
- If a bit of the mappable NETWordIN1 data word is to be used for activation, use [0x400E:001 \(PAR 505/001\)](#) to assign function "17: Setpoint = Network" to the corresponding bit of NETWordIN1. ▶ [General network settings](#) 97
- There is no specific function with a selectable trigger for a setpoint change-over to the network.



11.3.5 Setpoint source of preset setpoints

The four functions "Preset val. selection bit 0" ... "Preset val. selection bit 3" enable change-over of the setpoint to a parameterisable setpoint (preset value).

Preconditions

The setpoint is only changed over to the respective preset value if no setpoint source with a higher priority has been selected. (For the preset setpoints, the trigger with the highest priority of the four triggers is decisive.) ▶ [Priority of the setpoint sources](#) 193

Details

A preset value is selected in a binary-coded fashion via the triggers assigned to the four functions "Preset val. selection bit 0" ... "Preset val. selection bit 3" in compliance with the following truth table:

Preset value selection Bit 3	Preset value selection Bit 2	Preset value selection Bit 1	Preset value selection Bit 0	Selection		
				Frequency setpoint	Process controller setpoint	Torque setpoint
FALSE	FALSE	FALSE	FALSE	No selection		
FALSE	FALSE	FALSE	TRUE	0x2911:1	0x4022:1	0x2912:1
FALSE	FALSE	TRUE	FALSE	0x2911:2	0x4022:2	0x2912:2
FALSE	FALSE	TRUE	TRUE	0x2911:3	0x4022:3	0x2912:3
FALSE	TRUE	FALSE	FALSE	0x2911:4	0x4022:4	0x2912:4
FALSE	TRUE	FALSE	TRUE	0x2911:5	0x4022:5	0x2912:5
FALSE	TRUE	TRUE	FALSE	0x2911:6	0x4022:6	0x2912:6
FALSE	TRUE	TRUE	TRUE	0x2911:7	0x4022:7	0x2912:7
TRUE	FALSE	FALSE	FALSE	0x2911:8	0x4022:8	0x2912:8
TRUE	FALSE	FALSE	TRUE	0x2911:9		
...				...		
TRUE	TRUE	TRUE	TRUE	0x2911:15		

Parameter	Name / value range / [default setting]	Info
0x2631:018 (PAR 400/018)	Function assignment: Preset val. selection bit 0 (Function list: Preset b0) • For possible settings see description for 0x2631:001 (PAR 400/001) . 188	Assignment of a trigger for the "Preset val. selection bit 0" function. Selection bit with the valency 20 for the bit-coded selection and activation of a parameterised setpoint (preset value). Trigger = FALSE: selection bit = "0". Trigger = TRUE: selection bit = "1".
	14 Digital input 4	State of X3/DI4, taking an inversion set in 0x2632:004 (PAR 411/004) into consideration.
0x2631:019 (PAR 400/019)	Function assignment: Preset val. selection bit 1 (Function list: Preset b1) • For possible settings see description for 0x2631:001 (PAR 400/001) . 188	Assignment of a trigger for the "Preset val. selection bit 1" function. Selection bit with the valency 21 for the bit-coded selection and activation of a parameterised setpoint (preset value). Trigger = FALSE: selection bit = "0". Trigger = TRUE: selection bit = "1".
	15 Digital input 5	State of X3/DI5, taking an inversion set in 0x2632:005 (PAR 411/005) into consideration.
0x2631:020 (PAR 400/020)	Function assignment: Preset val. selection bit 2 (Function list: Preset b2) • For possible settings see description for 0x2631:001 (PAR 400/001) . 188	Assignment of a trigger for the "Preset val. selection bit 2" function. Selection bit with the valency 22 for the bit-coded selection and activation of a parameterised setpoint (preset value). Trigger = FALSE: selection bit = "0". Trigger = TRUE: selection bit = "1".
	00 Not connected	No trigger assigned (trigger is constantly FALSE).
0x2631:021 (PAR 400/021)	Function assignment: Preset val. selection bit 3 (Function list: Preset b3) • For possible settings see description for 0x2631:001 (PAR 400/001) . 188	Assignment of a trigger for the "Preset val. selection bit 3" function. Selection bit with the valency 2 ³ for the bit-coded selection and activation of a parameterised setpoint (preset value). Trigger = FALSE: selection bit = "0". Trigger = TRUE: selection bit = "1".
	00 Not connected	No trigger assigned (trigger is constantly FALSE).

Flexible I/O configuration

Setpoint change-over

Setpoint source of preset setpoints



Parameter	Name / value range / [default setting]	Info
0x2631:022 (PAR 400/022)	Function assignment: Setpoint = Digital frequency input (Function list: Setp=Dig freq in) <ul style="list-style-type: none"> For possible settings see description for 0x2631:001 (PAR 400/001). □ 188 	Assignment of a trigger for the "Setpoint = Digital frequency input" function. Trigger = TRUE: the frequency of the input pulse train at digital input 1 is used as setpoint (if the trigger assigned has the highest setpoint priority). Trigger = FALSE: no action / deactivate function again.
	00 Not connected	No trigger assigned (trigger is constantly FALSE).
0x2911:001 (PAR 450/001)	Preset frequency values: Preset value 1 (Preset frequency values: Preset value 1) 0.0 ... [20.0] ... 599.0 Hz	Parameterisable frequency setpoints (preset values) for speed mode.
0x2911:002 (PAR 450/002)	Preset frequency values: Preset value 2 (Preset frequency values: Preset value 2) 0.0 ... [40.0] ... 599.0 Hz	
0x2911:003 (PAR 450/003)	Preset frequency values: Preset value 3 (Preset frequency values: Preset value 3) 0.0 ... [50.0] ... 599.0 Hz	
0x2911:004 (PAR 450/004)	Preset frequency values: Preset value 4 (Preset frequency values: Preset value 4) 0.0 ... [0.0] ... 599.0 Hz	
0x2911:005 (PAR 450/005)	Preset frequency values: Preset value 5 (Preset frequency values: Preset value 5) 0.0 ... [0.0] ... 599.0 Hz	
0x2911:006 (PAR 450/006)	Preset frequency values: Preset value 6 (Preset frequency values: Preset value 6) 0.0 ... [0.0] ... 599.0 Hz	
0x2911:007 (PAR 450/007)	Preset frequency values: Preset value 7 (Preset frequency values: Preset value 7) 0.0 ... [0.0] ... 599.0 Hz	
0x2911:008 (PAR 450/008)	Preset frequency values: Preset value 8 (Preset frequency values: Preset value 8) 0.0 ... [0.0] ... 599.0 Hz	
0x2911:009 (PAR 450/009)	Preset frequency values: Preset value 9 (Preset frequency values: Preset value 9) 0.0 ... [0.0] ... 599.0 Hz	
0x2911:010 (PAR 450/010)	Preset frequency values: Preset value 10 (Preset frequency values: Preset value 10) 0.0 ... [0.0] ... 599.0 Hz	
0x2911:011 (PAR 450/011)	Preset frequency values: Preset value 11 (Preset frequency values: Preset value 11) 0.0 ... [0.0] ... 599.0 Hz	
0x2911:012 (PAR 450/012)	Preset frequency values: Preset value 12 (Preset frequency values: Preset value 12) 0.0 ... [0.0] ... 599.0 Hz	
0x2911:013 (PAR 450/013)	Preset frequency values: Preset value 13 (Preset frequency values: Preset value 13) 0.0 ... [0.0] ... 599.0 Hz	
0x2911:014 (PAR 450/014)	Preset frequency values: Preset value 14 (Preset frequency values: Preset value 14) 0.0 ... [0.0] ... 599.0 Hz	
0x2911:015 (PAR 450/015)	Preset frequency values: Preset value 15 (Preset frequency values: Preset value 15) 0.0 ... [0.0] ... 599.0 Hz	



Flexible I/O configuration

Setpoint change-over
Setpoint source of preset setpoints

Parameter	Name / value range / [default setting]	Info
0x2912:001 (PAR 452/001)	Preset torque values: Preset value 1 (Preset torque values: Preset value 1) -400.0 ... [100.0] ... 400.0 %	Parameterisable torque setpoints (preset values) for torque mode.
0x2912:002 (PAR 452/002)	Preset torque values: Preset value 2 (Preset torque values: Preset value 2) -400.0 ... [100.0] ... 400.0 %	
0x2912:003 (PAR 452/003)	Preset torque values: Preset value 3 (Preset torque values: Preset value 3) -400.0 ... [100.0] ... 400.0 %	
0x2912:004 (PAR 452/004)	Preset torque values: Preset value 4 (Preset torque values: Preset value 4) -400.0 ... [100.0] ... 400.0 %	
0x2912:005 (PAR 452/005)	Preset torque values: Preset value 5 (Preset torque values: Preset value 5) -400.0 ... [100.0] ... 400.0 %	
0x2912:006 (PAR 452/006)	Preset torque values: Preset value 6 (Preset torque values: Preset value 6) -400.0 ... [100.0] ... 400.0 %	
0x2912:007 (PAR 452/007)	Preset torque values: Preset value 7 (Preset torque values: Preset value 7) -400.0 ... [100.0] ... 400.0 %	
0x2912:008 (PAR 452/008)	Preset torque values: Preset value 8 (Preset torque values: Preset value 8) -400.0 ... [100.0] ... 400.0 %	
0x4022:001 (PAR 451/001)	Preset process controller values: Preset value 1 (PID preset setpoint: Preset value 1) -300.00 ... [0.00] ... 300.00 PUnit	Parameterisable process controller setpoints (preset values) for process controller mode.
0x4022:002 (PAR 451/002)	Preset process controller values: Preset value 2 (PID preset setpoint: PID preset 2) -300.00 ... [0.00] ... 300.00 PUnit	
0x4022:003 (PAR 451/003)	Preset process controller values: Preset value 3 (PID preset setpoint: PID preset 3) -300.00 ... [0.00] ... 300.00 PUnit	
0x4022:004 (PAR 451/004)	Preset process controller values: Preset value 4 (PID preset setpoint: PID preset 4) -300.00 ... [0.00] ... 300.00 PUnit	
0x4022:005 (PAR 451/005)	Preset process controller values: Preset value 5 (PID preset setpoint: PID preset 5) -300.00 ... [0.00] ... 300.00 PUnit	
0x4022:006 (PAR 451/006)	Preset process controller values: Preset value 6 (PID preset setpoint: PID preset 6) -300.00 ... [0.00] ... 300.00 PUnit	
0x4022:007 (PAR 451/007)	Preset process controller values: Preset value 7 (PID preset setpoint: PID preset 7) -300.00 ... [0.00] ... 300.00 PUnit	
0x4022:008 (PAR 451/008)	Preset process controller values: Preset value 8 (PID preset setpoint: PID preset 8) -300.00 ... [0.00] ... 300.00 PUnit	

Flexible I/O configuration

Setpoint change-over
Motor potentiometer setpoint source



11.3.6 Motor potentiometer setpoint source

The "Motor potentiometer" function can be used as an alternative setpoint control that is controlled via two functions: "Motor potentiometer up" and "Motor potentiometer down".

The "Setpoint = Motor potentiometer" function enables a setpoint change-over to the motor potentiometer.

Preconditions

A setpoint change-over to the motor potentiometer is only effected if

- no setpoint source with a higher priority has been selected. ▶ [Priority of the setpoint sources](#) 193
- no jog operation is active ("Foward jog (CW)" and "Backward jog (CCW)" functions).

Details

If the motor potentiometer is active as setpoint source, the setpoint generated by this function ("MOP value") can be changed according to the truth table via the triggers assigned to the two "Motor potentiometer up" and "Motor potentiometer down" functions:

Motor potentiometer up	Motor potentiometer down	Response of the function
FALSE	FALSE	Last MOP value is maintained.
TRUE	FALSE	MOP value is increased to a maximum of the upper range limit with acceleration time 2.
FALSE	TRUE	MOP value is decreased to a maximum of the lower range limit with deceleration time 2.
TRUE	TRUE	Last MOP value is maintained.

Starting performance

- In the default setting, the last MOP value is used as initial value. As an alternative, an adjustable initial value or the minimum value can be used for starting. The starting performance can be selected in [0x4003 \(PAR 413\)](#).
- The last MOP value is still provided after switching the mains voltage off and on again.

Range limits, acceleration times, and deceleration times

Parameter	Speed mode	Process controller mode
Lower range limit	Minimum frequency 0x2915 (PAR 210)	Setpoint limits (process controller): Minimum setpoint 0x404E:001 (PAR 605/001)
Upper range limit	Maximum frequency 0x2916 (PAR 211)	Setpoint limits (process controller): Maximum setpoint 0x404E:002 (PAR 605/002)
Acceleration time	Acceleration time 2 0x2919 (PAR 222)	Setpoint ramp (process controller) 0x404B (PAR 604)
Deceleration time	Deceleration time 2 0x291A (PAR 223)	Setpoint ramp (process controller) 0x404B (PAR 604)

Parameter	Name / value range / [default setting]	Info
0x2631:023 (PAR 400/023)	Function assignment: Motor potentiometer up (<i>Function list: MOP up</i>) • For possible settings see description for 0x2631:001 (PAR 400/001) . 188	Assignment of a trigger for the "Motor potentiometer up" function. Trigger = TRUE: setpoint generated by the "Motor potentiometer" function ("MOP value") is maximally increased to the upper range limit with acceleration time 2. Trigger = FALSE: last MOP value is maintained. Notes: • If the "Motor potentiometer up" and "Motor potentiometer down" functions are active at the same time, the last MOP value is maintained. • Acceleration time 2 can be set in 0x2919 (PAR 222) .
	00 Not connected	No trigger assigned (trigger is constantly FALSE).



Flexible I/O configuration

Setpoint change-over
Motor potentiometer setpoint source

Parameter	Name / value range / [default setting]	Info
0x2631:024 (PAR 400/024)	Function assignment: Motor potentiometer down (Function list: MOP down) <ul style="list-style-type: none"> For possible settings see description for 0x2631:001 (PAR 400/001). □ 188 	Assignment of a trigger for the "Motor potentiometer down" function. Trigger = TRUE: setpoint generated by the "Motor potentiometer" function ("MOP value") is maximally decreased to the lower range limit with deceleration time 2. Trigger = FALSE: last MOP value is maintained. Notes: <ul style="list-style-type: none"> If the "Motor potentiometer up" and "Motor potentiometer down" functions are active at the same time, the last MOP value is maintained. Deceleration time 2 can be set in 0x291A (PAR 223).
	00 Not connected	No trigger assigned (trigger is constantly FALSE).
0x2631:025 (PAR 400/025)	Function assignment: Setpoint = Motor potentiometer (Function list: Setpoint=MOP) <ul style="list-style-type: none"> For possible settings see description for 0x2631:001 (PAR 400/001). □ 188 	Assignment of a trigger for the "Setpoint = Motor potentiometer" function. Trigger = TRUE: the "Motor potentiometer" function is used as setpoint source (if the trigger assigned has the highest setpoint priority). Trigger = FALSE: no action / deactivate function again.
	00 Not connected	No trigger assigned (trigger is constantly FALSE).
0x4003 (PAR 413)	Motor potentiometer starting mode (MOP startmod)	Selection of the initial value which is used after activation of the function.
	0 Last value	The last MOP value is used as initial value. It is still provided after the mains voltage has been switched off and on again.
	1 Starting value	Depending on the operating mode, the value set in 0x4004:1...3 is used as initial value.
	2 Minimum Value	The minimum value of the corresponding operating mode is used as initial value.
0x4004:001 (PAR 414/001)	Motor potentiometer starting values: Frequency (MOP starting value: MOP starting freq) 0.0 ... [0.0] ... 599.0 Hz	Initial value for speed mode. Only relevant for 0x4003 = 1.
0x4004:002 (PAR 414/002)	Motor potentiometer starting values: Process controller value (MOP starting value: MOP starting PID) -300.00 ... [0.00] ... 300.00 PUnit	Initial value for process controller mode. Only relevant for 0x4003 = 1.
0x4004:003 (PAR 414/003)	Motor potentiometer starting values: Torque (MOP starting value: MOP starting torque) 0.0 ... [0.0] ... 1000.0 %	Initial value for torque mode. Only relevant for 0x4003 = 1.
0x4009:001	Motor potentiometer values saved: Frequency <ul style="list-style-type: none"> Read only: x.x Hz 	Display of the last MOP value saved internally. <ul style="list-style-type: none"> This value is used as initial value in speed mode if 0x4003 = 0 is set.
0x4009:002	Motor potentiometer values saved: Process controller value <ul style="list-style-type: none"> Read only: x.xx PUnit 	Display of the last MOP value saved internally. <ul style="list-style-type: none"> This value is used as initial value in process controller mode if 0x4003 = 0 is set.
0x4009:003	Motor potentiometer values saved: Torque <ul style="list-style-type: none"> Read only: x.x % 	Display of the last MOP value saved internally. <ul style="list-style-type: none"> This value is used as initial value in torque mode if 0x4003 = 0 is set.
0x2915 (PAR 210)	Minimum frequency (Min. frequency) 0.0 ... [0.0] ... 599.0 Hz	Lower limit value for all frequency setpoints.
0x2916 (PAR 211)	Maximum frequency (Max. frequency) 0.0 ... [50.0] ... 599.0 Hz	Upper limit value for all frequency setpoints.
0x2919 (PAR 222)	Acceleration time 2 (Acceleration time 2) 0.0 ... [5.0] ... 3600.0 s	The acceleration time set refers to the acceleration from standstill to the maximum frequency set. In the case of a lower setpoint selection, the actual acceleration time is reduced accordingly. Acceleration time 2 is active if <ul style="list-style-type: none"> "Motor potentiometer" function is active, or frequency setpoint (absolute value) > auto-change-over threshold 0x291B (PAR 224), or the trigger assigned in 0x2631:039 (PAR 400/039) of the "Activate ramp 2" function is TRUE.

Flexible I/O configuration

Setpoint change-over

Motor potentiometer setpoint source



Parameter	Name / value range / [default setting]	Info
0x291A (PAR 223)	Deceleration time 2 (Deceleration time 2) 0.0 ... [5.0] ... 3600.0 s	<p>The deceleration time set refers to the deceleration from the maximum frequency set to standstill. In the case of a lower actual frequency, the actual deceleration time is reduced accordingly.</p> <p>Deceleration time 2 is active if</p> <ul style="list-style-type: none">• "Motor potentiometer" function is active, or• frequency setpoint (absolute value) > auto-change-over threshold 0x291B (PAR 224), or• the trigger assigned in 0x2631:039 (PAR 400/039) of the "Activate ramp 2" function is TRUE.



11.4 Reset error

By means of the "Reset error" function, an active error can be reset (acknowledged).

Preconditions

The error can only be reset if the error cause has been eliminated.

Parameter	Name / value range / [default setting]	Info
0x2631:004 (PAR 400/004)	Function assignment: Reset error (Function list: Reset error) <ul style="list-style-type: none"> For possible settings see description for 0x2631:001 (PAR 400/001). 188 	Assignment of a trigger for the "Reset error" function. Trigger = FALSE-TRUE edge: active error is reset (acknowledged) if the error cause has been eliminated. Trigger = FALSE: no action. Notes: <ul style="list-style-type: none"> After resetting the error, a new enable/start command is required to restart the drive.
	12 Digital input 2	State of X3/DI2, taking an inversion set in 0x2632:002 (PAR 411/002) into consideration.

Flexible I/O configuration

Activating DC braking manually



11.5 Activating DC braking manually

By means of the "DC braking" function, DC braking can be activated manually.

Preconditions

The current for DC braking must be set > 0 % so that the function can be executed.

Parameter	Name / value range / [default setting]	Info
0x2631:005 (PAR 400/005)	Function assignment: DC braking (Function list: DC braking) <ul style="list-style-type: none">For possible settings see description for 0x2631:001 (PAR 400/001). □ 188	Assignment of a trigger for the "DC braking" function. Trigger = TRUE: "DC braking" function is activated. Trigger = FALSE: no actions / deactivate function again. ▶ DC braking □ 153
	00 Not connected	No trigger assigned (trigger is constantly FALSE).
0x2B84:001 (PAR 704/001)	DC braking: Current (DC braking: Current) 0.0 ... [0.0] ... 200.0 %	Braking current for DC braking. <ul style="list-style-type: none">100 % ≙ rated motor current 0x6075 (PAR 323)



11.6 Releasing holding brake manually

The "Release holding brake" function is used to release the holding brake manually.

Preconditions

- Observe setting and application notes in the "[Holding brake control](#)" chapter! [📖 180](#)
- The operating mode of the holding brake control has to be set in [0x2820:001 \(PAR 712/001\)](#) to "Manual [1]".
- The "Release holding brake [115]" trigger has to be assigned to a digital output or, in the simplest case, to the relay which then switches the brake supply.

Details

Detailed information about the function and configuration of the holding brake control can be found in the "[Holding brake control](#)" chapter. [📖 180](#)

Parameter	Name / value range / [default setting]	Info
0x2631:049 (PAR 400/049)	Function assignment: Release holding brake (Function list: Release brake) <ul style="list-style-type: none"> • Setting can only be changed if controller inhibit is active. • For possible settings see description for 0x2631:001 (PAR 400/001). 📖 188 	Assignment of a trigger for the "Release holding brake" function. Trigger = TRUE: release holding brake in manual mode. Trigger = FALSE: no action. Notes: <ul style="list-style-type: none"> • Function is only executed if the operating mode of the holding brake in 0x2820:001 (PAR 712/001) is set to "Manual [1]".
	00 Not connected	No trigger assigned (trigger is constantly FALSE).

Flexible I/O configuration

Activating ramp 2 manually



11.7 Activating ramp 2 manually

The "Activate ramp 2" function serves to manually activate acceleration time 2 and deceleration time 2.

Parameter	Name / value range / [default setting]	Info
0x2631:039 (PAR 400/039)	Function assignment: Activate ramp 2 (Function list: <i>Activ. ramp 2</i>) <ul style="list-style-type: none"> For possible settings see description for 0x2631:001 (PAR 400/001). 188 	Assignment of a trigger for the "Activate ramp 2" function. Trigger = TRUE: activate acceleration time 2 and deceleration time 2 manually. Trigger = FALSE: no action / deactivate function again. Notes: <ul style="list-style-type: none"> Acceleration time 2 and deceleration time 2 are also active if the "Motor potentiometer" function is active or the frequency setpoint (absolute value) > auto-changeover threshold 0x291B (PAR 224). Acceleration time 2 can be set in 0x2919 (PAR 222). Deceleration time 2 can be set in 0x291A (PAR 223).
	00 Not connected	No trigger assigned (trigger is constantly FALSE).
0x2917 (PAR 220)	Acceleration time 1 (<i>Acceleration time 1</i>) 0.0 ... [5.0] ... 3600.0 s	The acceleration time set refers to the acceleration from standstill to the maximum frequency set. In the case of a lower setpoint selection, the actual acceleration time is reduced accordingly.
0x2918 (PAR 221)	Deceleration time 1 (<i>Deceleration time 1</i>) 0.0 ... [5.0] ... 3600.0 s	The deceleration time set refers to the deceleration from the maximum frequency set to standstill. In the case of a lower actual frequency, the actual deceleration time is reduced accordingly.
0x2919 (PAR 222)	Acceleration time 2 (<i>Acceleration time 2</i>) 0.0 ... [5.0] ... 3600.0 s	The acceleration time set refers to the acceleration from standstill to the maximum frequency set. In the case of a lower setpoint selection, the actual acceleration time is reduced accordingly. Acceleration time 2 is active if <ul style="list-style-type: none"> "Motor potentiometer" function is active, or frequency setpoint (absolute value) > auto-change-over threshold 0x291B (PAR 224), or the trigger assigned in 0x2631:039 (PAR 400/039) of the "Activate ramp 2" function is TRUE.
0x291A (PAR 223)	Deceleration time 2 (<i>Deceleration time 2</i>) 0.0 ... [5.0] ... 3600.0 s	The deceleration time set refers to the deceleration from the maximum frequency set to standstill. In the case of a lower actual frequency, the actual deceleration time is reduced accordingly. Deceleration time 2 is active if <ul style="list-style-type: none"> "Motor potentiometer" function is active, or frequency setpoint (absolute value) > auto-change-over threshold 0x291B (PAR 224), or the trigger assigned in 0x2631:039 (PAR 400/039) of the "Activate ramp 2" function is TRUE.



11.8 Triggering a user-defined fault

The "User-defined fault 1" and "User-defined fault 2" functions serve to set the inverter from the process to the error status.

Details

If, for instance, sensors or switches are provided for process monitoring, which are designed to stop the process (and thus the drive) under certain conditions, these sensors/switches can be connected to free digital inputs of the inverter. The digital inputs used for the sensors/switches then have to be assigned to the error triggering functions as triggers.

Parameter	Name / value range / [default setting]	Info
0x2631:043 (PAR 400/043)	Function assignment: User-defined fault 1 (Function list: <i>User-def fault 1</i>) <ul style="list-style-type: none"> For possible settings see description for 0x2631:001 (PAR 400/001). 188 	Assignment of a trigger for the "User-defined fault 1" function. Trigger = TRUE: trigger user-defined fault 1. Trigger = FALSE: no action. Notes: <ul style="list-style-type: none"> When the fault has been triggered, the inverter changes to the "Trouble" state. After resetting the fault, a new enable/start command is required to restart the drive.
	00 Not connected	No trigger assigned (trigger is constantly FALSE).
0x2631:044 (PAR 400/044)	Function assignment: User-defined fault 2 (Function list: <i>User-def fault 2</i>) <ul style="list-style-type: none"> For possible settings see description for 0x2631:001 (PAR 400/001). 188 	Assignment of a trigger for the "User-defined fault 2" function. Trigger = TRUE: trigger user-defined fault 2. Trigger = FALSE: no action. Notes: <ul style="list-style-type: none"> When the fault has been triggered, the inverter changes to the "Trouble" state. After resetting the fault, a new enable/start command is required to restart the drive.
	00 Not connected	No trigger assigned (trigger is constantly FALSE).

Flexible I/O configuration

Functions for parameter change-over



11.9 Functions for parameter change-over

The inverter supports several parameter sets. The parameter set can be selected by means of the "Parameter set selection bit 0" and "Parameter set selection bit 1" functions.

Details

A value set is selected in a binary-coded fashion via the triggers assigned to the two Parameter set selection bit 0" and "Parameter set selection bit 1" functions in compliance with the following truth table:

Parameter set selection bit 1	Parameter set selection bit 0	Selection
FALSE	FALSE	Value set 1
FALSE	TRUE	Value set 2
TRUE	FALSE	Value set 3
TRUE	TRUE	Value set 4

Change-over is effected depending on the activation method selected in [0x4046 \(PAR 755\)](#) when a state change of the selection inputs takes place or via the trigger assigned to the "Load parameter set" function.

Parameter	Name / value range / [default setting]	Info
0x2631:040 (PAR 400/040)	Function assignment: Load parameter set (Function list: Load param.set) <ul style="list-style-type: none"> Setting can only be changed if controller inhibit is active. For possible settings see description for 0x2631:001 (PAR 400/001). 188 	Assignment of a trigger for the "Load parameter set" function. Trigger = FALSE-TRUE edge: parameter change-over to the value set selected via "Parameter set selection bit 0" and "Parameter set selection bit 1". Trigger = FALSE: no action. Notes: <ul style="list-style-type: none"> The activation method for the "Parameter change-over" function can be selected in 0x4046 (PAR 755).
	00 Not connected	No trigger assigned (trigger is constantly FALSE).
0x2631:041 (PAR 400/041)	Function assignment: Parameter set selection bit 0 (Function list: Par.set selection b0) <ul style="list-style-type: none"> Setting can only be changed if controller inhibit is active. For possible settings see description for 0x2631:001 (PAR 400/001). 188 	Assignment of a trigger for the "Parameter set selection bit 0" function. Selection bit with the valency 2 ⁰ for "Parameter change-over" function. Trigger = FALSE: selection bit = "0". Trigger = TRUE: selection bit = "1".
	00 Not connected	No trigger assigned (trigger is constantly FALSE).
0x2631:042 (PAR 400/042)	Function assignment: Parameter set selection bit 1 (Function list: Par.set selection b1) <ul style="list-style-type: none"> Setting can only be changed if controller inhibit is active. For possible settings see description for 0x2631:001 (PAR 400/001). 188 	Assignment of a trigger for the "Parameter set selection bit 1" function. Selection bit with the valency 2 ¹ for "Parameter change-over" function. Trigger = FALSE: selection bit = "0". Trigger = TRUE: selection bit = "1".
	00 Not connected	No trigger assigned (trigger is constantly FALSE).
0x4046 (PAR 755)	Activation of parameter set (Param. set mode)	Selection of the activation method for the parameter change-over.
	0 Via command (only if the controller is inhibited)	The parameter set selected via the "Parameter set selection bit 0" and "Parameter set selection bit 1" functions is activated if the trigger assigned in 0x2631:040 (PAR 400/040) of the "Load parameter set" function supplies a FALSE-TRUE edge AND the inverter is inhibited.
	1 Via command (immediately)	The parameter set selected via the "Parameter set selection bit 0" and "Parameter set selection bit 1" functions is activated if the trigger assigned in 0x2631:040 (PAR 400/040) of the "Load parameter set" function supplies a FALSE-TRUE edge.
	2 If the selection is changed (only if the controller is inhibited)	The parameter set selected via the "Parameter set selection bit 0" and "Parameter set selection bit 1" functions is activated if a state change of these selection bits takes place AND the inverter is inhibited.
	3 If the selection is changed (immediately)	The parameter set selected via the "Parameter set selection bit 0" and "Parameter set selection bit 1" functions is activated if a state change of these selection bits takes place.



11.10 Process controller function selection

By means of the following functions, the response of the inverter in process controller mode can be controlled. ▶ [Configuring the process controller](#) [138](#)

Parameter	Name / value range / [default setting]	Info
0x2631:045 (PAR 400/045)	Function assignment: Process controller off (Function list: PID off) • For possible settings see description for 0x2631:001 (PAR 400/001) . 188	Assignment of a trigger for the "Process controller off" function. Trigger = TRUE: if process controller mode is active, ignore PID control and actuate the drive in speed-controlled manner. Trigger = FALSE: if process controller mode is active, actuate the drive with PID control. Notes: • The PID control mode can be selected in 0x4020:001 (PAR 600/001) .
	00 Not connected	No trigger assigned (trigger is constantly FALSE).
0x2631:046 (PAR 400/046)	Function assignment: Set process controller output to 0 (Function list: PID output=0) • For possible settings see description for 0x2631:001 (PAR 400/001) . 188	Assignment of a trigger for the "Set process controller output to 0" function. Trigger = TRUE: if process controller mode is active, the I-component and the output of the process controller are set to 0 and the internal control algorithm is stopped. Process controller mode remains active. Trigger = FALSE: no action / deactivate function again.
	00 Not connected	No trigger assigned (trigger is constantly FALSE).
0x2631:047 (PAR 400/047)	Function assignment: Inhibit process controller I-component (Function list: PID-I inhibited) • For possible settings see description for 0x2631:001 (PAR 400/001) . 188	Assignment of a trigger for the "Inhibit process controller I-component" function. Trigger = TRUE: if process controller mode is active, the I-component of the process controller is set to 0 and the integration process is stopped. Trigger = FALSE: no action / deactivate function again. Notes: • The reset time can be set in 0x4049 (PAR 602) .
	00 Not connected	No trigger assigned (trigger is constantly FALSE).
0x2631:048 (PAR 400/048)	Function assignment: Activate process controller influence ramp (Function list: PID-Inf ramp on) • For possible settings see description for 0x2631:001 (PAR 400/001) . 188	Assignment of a trigger for the "Activate process controller influence ramp" function. Trigger = TRUE: the influence of the process controller is shown via a ramp. Trigger = FALSE or not connected: the influence of the process controller is hidden via ramp. Notes: • The influence of the process controller is always active (not only in process controller mode). • Acceleration time for showing the influence of the process controller can be set in 0x404C:001 (PAR 607/001) . • Deceleration time for hiding the influence of the process controller can be set in 0x404C:002 (PAR 607/002) .
	01 Constant TRUE	Trigger is constantly TRUE.
0x4020:001 (PAR 600/001)	Process controller: Operating mode (Process controller: Operating mode)	Selection of the process controller operating mode.
	0 Inhibited	Process controller deactivated.
	1 Normal operation	If the controlled variable (actual value) fed back is reduced, the motor speed is increased. Example: pressure-controlled booster pumps (increase in the motor speed produces an increase in pressure.)
	2 Reversing duty	If the controlled variable (actual value) fed back is reduced, the motor speed is also reduced. Example: temperature-controlled cooling water pump (increase in motor speed produces decrease in temperature.)
	3 Normal operation in both rotating directions	As selection 1, but also inverted rotating direction possible if both rotating directions are enabled with the setting 0x283A (PAR 304) = 1.
4 Reversing duty in both rotating directions	As selection 2, but also inverted rotating direction possible if both rotating directions are enabled with the setting 0x283A (PAR 304) = 1.	
0x4049 (PAR 602)	I component reset time (I-deceleration) 20 ... [400] ... 6000 ms	Reset time for system deviation. • With the setting "6000 ms", the I component is deactivated. • The I component can also be deactivated via a trigger assigned in 0x2631:047 (PAR 400/047) of the "Inhibit process controller I-component" 0x2631:047 (PAR 400/047) function.

Flexible I/O configuration

Process controller function selection



Parameter	Name / value range / [default setting]	Info
0x404C:001 (PAR 607/001)	Process controller influence: Acceleration time for showing (PID influence: Show time) 0.0 ... [5.0] ... 999.9 s	If the trigger assigned in 0x2631:048 (PAR 400/048) of the "Activate process controller influence ramp" function is TRUE, the influence of the process controller is shown by means of a ramp with the acceleration time set here.
0x404C:002 (PAR 607/002)	Process controller influence: Deceleration time for masking out (PID influence: Mask out time) 0.0 ... [5.0] ... 999.9 s	If the trigger assigned in 0x2631:048 (PAR 400/048) of the "Activate process controller influence ramp" function is FALSE, the influence of the process controller is hidden via a ramp with the deceleration time set here.



11.11 Frequency threshold for "Frequency threshold exceeded" trigger

The "Frequency threshold exceeded [70]" trigger can be used to trigger a certain function or set a digital output when the motor frequency exceeds the set frequency threshold set in the following parameter.

Parameter	Name / value range / [default setting]	Info
0x4005 (PAR 412)	Frequency threshold (<i>Freq. threshold</i>) 0.0 ... [0.0] ... 599.0 Hz	Threshold for the "Frequency threshold exceeded" trigger. <ul style="list-style-type: none">• The "Frequency threshold exceeded" trigger is TRUE if the current output frequency > the threshold set.• The trigger can be assigned to a function or to a digital output.

Flexible I/O configuration

Configuration of digital inputs



11.12 Configuration of digital inputs

Settings for digital inputs 1 ... 5.

Parameter	Name / value range / [default setting]	Info
0x2630:002 (PAR 410/002)	Settings for digital inputs: Input function (DigIn HW config.: DigIn HW mode)	Function assignment of digital terminals DI3 and DI4.
	0 Digital input	DI3 = digital input DI4 = digital input
0x2632:001 (PAR 411/001)	Inversion of digital inputs: Digital input 1 (DI inversion: DI1 inversion)	Inversion of digital input 1
	0 Not inverted	
	1 Inverted	
0x2632:002 (PAR 411/002)	Inversion of digital inputs: Digital input 2 (DI inversion: DI2 inversion)	Inversion of digital input 2
	0 Not inverted	
	1 Inverted	
0x2632:003 (PAR 411/003)	Inversion of digital inputs: Digital input 3 (DI inversion: DI3 inversion)	Inversion of digital input 3
	0 Not inverted	
	1 Inverted	
0x2632:004 (PAR 411/004)	Inversion of digital inputs: Digital input 4 (DI inversion: DI4 inversion)	Inversion of digital input 4
	0 Not inverted	
	1 Inverted	
0x2632:005 (PAR 411/005)	Inversion of digital inputs: Digital input 5 (DI inversion: DI5 inversion)	Inversion of digital input 5
	0 Not inverted	
	1 Inverted	
0x2633:001	Digital input debounce time: Digital input 1 1 ... [1] ... 50 ms	Debounce time of digital input 1
0x2633:002	Digital input debounce time: Digital input 2 1 ... [1] ... 50 ms	Debounce time of digital input 2
0x2633:003	Digital input debounce time: Digital input 3 1 ... [1] ... 50 ms	Debounce time of digital input 3
0x2633:004	Digital input debounce time: Digital input 4 1 ... [1] ... 50 ms	Debounce time of digital input 4
0x2633:005	Digital input debounce time: Digital input 5 1 ... [1] ... 50 ms	Debounce time of digital input 5



11.13 Configuration of analog inputs

11.13.1 Analog input 1

Settings for analog input 1.

Details

- The internal output signal of the analog input is either a frequency setpoint or a process controller setpoint that is calculated from the percentage input value.
- The setting range can be individually defined for speed mode and process controller mode.
- Optionally, a dead band can be configured. Setpoints in this range that are centred around 0 Hz are ignored which is used to eliminate smallest signal levels for the setpoint frequency 0 Hz.

Definition of the setting range and dead band for speed mode

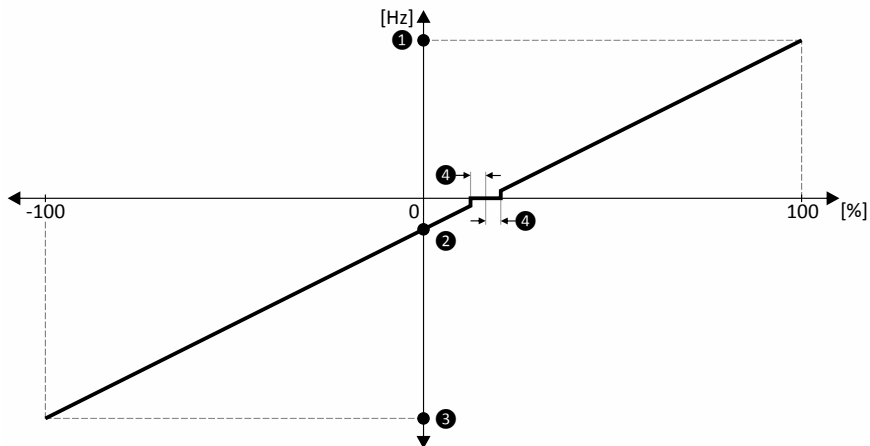

Parameter	Name	Notes
①	0x2636:003 (PAR 430/003)	Max value [Hz]
②	0x2636:002 (PAR 430/002)	Min value [Hz]
③		Only for mode -10 V ... +10 V
④	0x2636:007 (PAR 430/007)	Dead band
		A setting > 0 produces a dead band to the zero crossing of the [Hz] axis. The value set defines half the width of the dead band in [%].

Parameter	Name / value range / [default setting]	Info
0x2636:001 (PAR 430/001)	Analog input 1: Input range (Analog input 1: AI1 config.) 0 0 ... 10 VDC 1 0 ... 5 VDC 2 2 ... 10 VDC 3 -10 ... +10 VDC 4 4 ... 20 mA 5 0 ... 20 mA	Definition of the input range.
0x2636:002 (PAR 430/002)	Analog input 1: Min value [Hz] (Analog input 1: AI1 freq @ min) -1000.0 ... [0.0] ... 1000.0 Hz	Definition of the setting range for speed mode. • A negative setting only shifts the offset, but does not change the rotating direction. • The rotating direction is reversed if Min value [Hz] > Max value [Hz] is set.
0x2636:003 (PAR 430/003)	Analog input 1: Max value [Hz] (Analog input 1: AI1 freq @ max) -1000.0 ... [50.0] ... 1000.0 Hz	
0x2636:004 (PAR 430/004)	Analog input 1: Min value [Punit/%] (Analog input 1: AI1 PID/Mom@min) -300.00 ... [0.00] ... 300.00 PUnit/%	Definition of the setting range for process controller mode and torque mode.
0x2636:005 (PAR 430/005)	Analog input 1: Max value [Punit/%] (Analog input 1: AI1 PID/Mom@max) -300.00 ... [100.00] ... 300.00 PUnit/%	

Flexible I/O configuration

Configuration of analog inputs

Analog input 1



Parameter	Name / value range / [default setting]	Info
0x2636:006 (PAR 430/006)	Analog input 1: Filter time (Analog input 1: AI1 filter time) 0 ... [10] ... 10000 ms	PT1 time constant for low-pass filter. <ul style="list-style-type: none"> By the use of a low-pass filter, the impacts of noise to an analog signal can be minimised. For an optimum filter effect, first the noise frequency has to be determined. The time constant then has to be set so that it equals the reciprocal value of the double frequency.
0x2636:007 (PAR 430/007)	Analog input 1: Dead band (Analog input 1: AI1 dead band) 0.0 ... [0.0] ... 100.0 %	Optional setting of a dead band that is placed symmetrically around the frequency zero point. <ul style="list-style-type: none"> The value set defines half the width of the dead band in [%]. If the analog input value is within the dead band, the output value for the motor control is set to "0".
0x2636:008 (PAR 430/008)	Analog input 1: Monitoring threshold (Analog input 1: AI1 monit.level) -100.0 ... [0.0] ... 100.0 %	Trigger threshold for monitoring the analog input. <ul style="list-style-type: none"> 100 % \equiv 10 V (with configuration as voltage input) 100 % \equiv 20 mA (with configuration as current loop)
0x2636:009 (PAR 430/009)	Analog input 1: Monitoring condition (Analog input 1: AI1 monit.action)	Trigger condition for monitoring the analog input. <ul style="list-style-type: none"> If the trigger condition is met for at least 500 ms, the response set in subindex 10 is effected.
	0 Input value < trigger threshold	Input value < trigger threshold
	1 Input value > trigger threshold	Input value > trigger threshold
0x2636:010 (PAR 430/010)	Analog input 1: Monitoring response (Analog input 1: AI1 error resp.) <ul style="list-style-type: none"> For possible settings see description for 0x2D45:001 (PAR 310/001). 94 	Selection of the response to the triggering of the analog input monitoring. <ul style="list-style-type: none"> If a response is set, the "Error of analog input 1" trigger is also set to TRUE when the monitoring function is activated. The user can utilise this trigger to activate specific functions.
	3 Error	



11.13.2 Analog input 2

Settings for analog input 2.

Details

- The internal output signal of the analog input is either a frequency setpoint or a process controller setpoint that is calculated from the percentage input value.
- The setting range can be individually defined for speed mode and process controller mode.
- Optionally, a dead band can be configured. Setpoints in this range that are centred around 0 Hz are ignored which is used to eliminate smallest signal levels for the setpoint frequency 0 Hz.

Definition of the setting range and dead band for speed mode

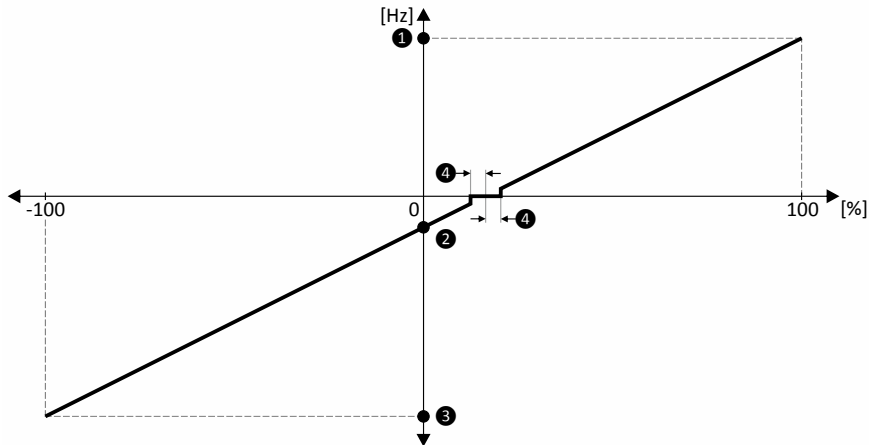

Parameter	Name	Notes
① 0x2637:003 (PAR 431/003)	Max value [Hz]	
② 0x2637:002 (PAR 431/002)	Min value [Hz]	For all modes except -10 V ... +10 V
③		Only for mode -10 V ... +10 V
④ 0x2637:007 (PAR 431/007)	Dead band	A setting > 0 produces a dead band to the zero crossing of the [Hz] axis. The value set defines half the width of the dead band in [%].

Parameter	Name / value range / [default setting]	Info
0x2637:001 (PAR 431/001)	Analog input 2: Input range (Analog input 2: AI2 config.) 0 0 ... 10 VDC 1 0 ... 5 VDC 2 2 ... 10 VDC 3 -10 ... +10 VDC 4 4 ... 20 mA 5 0 ... 20 mA	Definition of the input range.
0x2637:002 (PAR 431/002)	Analog input 2: Min value [Hz] (Analog input 2: AI2 freq @ min) -1000.0 ... [0.0] ... 1000.0 Hz	Definition of the setting range for speed mode. • A negative setting only shifts the offset, but does not change the rotating direction. • The rotating direction is reversed if Min value [Hz] > Max value [Hz] is set.
0x2637:003 (PAR 431/003)	Analog input 2: Max value [Hz] (Analog input 2: AI2 freq @ max) -1000.0 ... [50.0] ... 1000.0 Hz	
0x2637:004 (PAR 431/004)	Analog input 2: Min value [Punit/%] (Analog input 2: AI2 PID/Mom@min) -300.00 ... [0.00] ... 300.00 PUnit/%	Definition of the setting range for process controller mode and torque mode.
0x2637:005 (PAR 431/005)	Analog input 2: Max value [Punit/%] (Analog input 2: AI2 PID/Mom@max) -300.00 ... [100.00] ... 300.00 PUnit/%	

Flexible I/O configuration

Configuration of analog inputs

Analog input 2



Parameter	Name / value range / [default setting]	Info
0x2637:006 (PAR 431/006)	Analog input 2: Filter time (Analog input 2: AI2 filter time) 0 ... [10] ... 10000 ms	PT1 time constant for low-pass filter. <ul style="list-style-type: none"> By the use of a low-pass filter, the impacts of noise to an analog signal can be minimised. For an optimum filter effect, first the noise frequency has to be determined. The time constant then has to be set so that it equals the reciprocal value of the double frequency.
0x2637:007 (PAR 431/007)	Analog input 2: Dead band (Analog input 2: AI2 dead band) 0.0 ... [0.0] ... 100.0 %	Optional setting of a dead band that is placed symmetrically around the frequency zero point. <ul style="list-style-type: none"> The value set defines half the width of the dead band in [%]. If the analog input value is within the dead band, the output value for the motor control is set to "0".
0x2637:008 (PAR 431/008)	Analog input 2: Monitoring threshold (Analog input 2: AI2 monit.level) -100.0 ... [0.0] ... 100.0 %	Trigger threshold for monitoring the analog input. <ul style="list-style-type: none"> 100 % \equiv 10 V (with configuration as voltage input) 100 % \equiv 20 mA (with configuration as current loop)
0x2637:009 (PAR 431/009)	Analog input 2: Monitoring condition (Analog input 2: AI2 monit.action)	Trigger condition for monitoring the analog input. <ul style="list-style-type: none"> If the trigger condition is met for at least 500 ms, the response set in subindex 10 is effected.
	0 Input value < trigger threshold	Input value < trigger threshold
	1 Input value > trigger threshold	Input value > trigger threshold
0x2637:010 (PAR 431/010)	Analog input 2: Monitoring response (Analog input 2: AI2 error resp.) <ul style="list-style-type: none"> For possible settings see description for 0x2D45:001 (PAR 310/001). 94 	Selection of the response to the triggering of the analog input monitoring. <ul style="list-style-type: none"> If a response is set, the "Error of analog input 2" trigger is also set to TRUE when the monitoring function is activated. The user can utilise this trigger to activate specific functions.
	3 Error	



Flexible I/O configuration

Configuration of digital outputs

Relay

11.14 Configuration of digital outputs

11.14.1 Relay

Settings for the relay.

Parameter	Name / value range / [default setting]	Info
0x2634:001 (PAR 420/001)	Function assignment of digital outputs: Relay (Digital outputs: Relay function)	Assignment of a trigger to the relay. Trigger = FALSE: X9/NO-COM open and NC-COM closed. Trigger = TRUE: X9/NO-COM closed and NC-COM open. Notes: • An inversion set in 0x2635:001 (PAR 421/001) is taken into consideration here.
	0 Not connected	No trigger assigned (bit is constantly "0").
	1 Constant TRUE	Bit is constantly "1".
	11 Digital input 1	State of X3/DI1, taking an inversion set in 0x2632:001 (PAR 411/001) into consideration.
	12 Digital input 2	State of X3/DI2, taking an inversion set in 0x2632:002 (PAR 411/002) into consideration.
	13 Digital input 3	State of X3/DI3, taking an inversion set in 0x2632:003 (PAR 411/003) into consideration.
	14 Digital input 4	State of X3/DI4, taking an inversion set in 0x2632:004 (PAR 411/004) into consideration.
	15 Digital input 5	State of X3/DI5, taking an inversion set in 0x2632:005 (PAR 411/005) into consideration.
	16 Digital input 6	State of X3/DI6, taking an inversion set in into consideration.
	17 Digital input 7	State of X3/DI7, taking an inversion set in into consideration.
	34 NETWordIN2 - bit 0	State of NetWordIN2/bit 0. • Display of NetWordIN2 in 0x4008:002 (PAR 590/002). • For controlling the digital outputs via network, NetWordIN2 can be mapped to a process data input word.
	35 NETWordIN2 - bit 1	State of NetWordIN2/bit 1.
	36 NETWordIN2 - bit 2	State of NetWordIN2/bit 2.
	37 NETWordIN2 - bit 3	State of NetWordIN2/bit 3.
	38 NETWordIN2 - bit 4	State of NetWordIN2/bit 4.
	39 NETWordIN2 - bit 5	State of NetWordIN2/bit 5.
	40 NETWordIN2 - bit 6	State of NetWordIN2/bit 6.
	41 NETWordIN2 - bit 7	State of NetWordIN2/bit 7.
	42 NETWordIN2 - bit 8	State of NetWordIN2/bit 8.
	43 NETWordIN2 - bit 9	State of NetWordIN2/bit 9.
	44 NETWordIN2 - bit 10	State of NetWordIN2/bit 10.
	45 NETWordIN2 - bit 11	State of NetWordIN2/bit 11.
	46 NETWordIN2 - bit 12	State of NetWordIN2/bit 12.
	47 NETWordIN2 - bit 13	State of NetWordIN2/bit 13.
	48 NETWordIN2 - bit 14	State of NetWordIN2/bit 14.
	49 NETWordIN2 - bit 15	State of NetWordIN2/bit 15.
	50 Running	TRUE if motor is controlled (pulse width modulation on). Otherwise FALSE.
	51 Ready for operation	TRUE if operation is enabled AND no error is active. Otherwise FALSE.
	52 Controller enable	TRUE if inverter is not enabled OR stop command is active and output frequency = 0.
	53 Stop active	TRUE if inverter is not enabled OR Stop command is active and output frequency = 0. FALSE if inverter enabled OR quick stop active OR fault active OR output frequency ≠ 0.

Flexible I/O configuration

Configuration of digital outputs

Relay



Parameter	Name / value range / [default setting]	Info
54	Quick stop active	TRUE if quick stop is active. Otherwise FALSE. <ul style="list-style-type: none"> With the setting "Quick stop ramp -> switch-on inhibited" in 0x605A, the "Quick stop active" status is reset to FALSE after ramp-down to standstill. With the setting "Quick stop ramp -> quick stop active" in 0x605A, the "quick stop active" status remains TRUE until the "quick stop" function is activated.
55	Safe torque off (STO) active	TRUE if the integrated safety system has triggered the "Safe torque off" (STO) function. Otherwise FALSE.
56	Error active	TRUE if error is active. Otherwise FALSE.
57	Error (non-resettable)	TRUE if non-resettable error is active. Otherwise FALSE.
58	Device warning active	TRUE if warning is active. Otherwise FALSE. <ul style="list-style-type: none"> A warning has no impact on the operating status of the inverter. A warning is reset automatically if the cause has been eliminated.
59	Device fault active	TRUE if a fault is active. Otherwise FALSE. <ul style="list-style-type: none"> A fault deactivates control of the motor in the moment of its occurrence. A fault is reset automatically if the cause has been eliminated.
60	Heatsink temperature warning active	TRUE if current heatsink temperature > warning threshold for temperature monitoring. Otherwise FALSE. <ul style="list-style-type: none"> Display of the current heatsink temperature in 0x2D84:001 (PAR 117/001). Setting of the warning threshold in 0x2D84:002.
65	Motor PTC error active	TRUE if an error of the motor PTC has been detected. Otherwise FALSE.
66	Flying restart process active	TRUE if "Flying restart process" function is active. Otherwise FALSE. <ul style="list-style-type: none"> Flying restart function □ 182
67	DC braking active	TRUE if the "DC braking" function is active. Otherwise FALSE. <ul style="list-style-type: none"> DC braking □ 153
69	Reversal active	TRUE if reversal is active. Otherwise FALSE. <ul style="list-style-type: none"> Selection of the trigger for the "Reversal" function in 0x2631:013 (PAR 400/013).
70	Frequency threshold exceeded	TRUE if current output frequency > frequency threshold. Otherwise FALSE. <ul style="list-style-type: none"> Display of the current output frequency in 0x2DDD (PAR 100). Setting Frequency threshold in 0x4005 (PAR 412). Frequency threshold for "Frequency threshold exceeded" trigger □ 209
71	Actual speed = 0	TRUE if current output frequency = 0 Hz (± 0.01 Hz), irrespective of the operating mode. Otherwise FALSE. <ul style="list-style-type: none"> Display of the current output frequency in 0x2DDD (PAR 100).
72	Setpoint speed reached	TRUE if frequency setpoint reached. Otherwise FALSE.
73	Process controller feedback = setpoint	TRUE if the controlled variable fed back = process controller setpoint. Otherwise FALSE. <ul style="list-style-type: none"> Basic process controller settings □ 139
74	Process controller - idle state active	TRUE if the inverter is in "Sleep mode". Otherwise FALSE. <ul style="list-style-type: none"> Process controller idle state □ 142
75	Process controller - MIN alarm active	TRUE if the controlled variable fed back (in process controller mode) < MIN alarm threshold. Otherwise FALSE. <ul style="list-style-type: none"> Setting of MIN alarm threshold in 0x404D:001 (PAR 608/001). Basic process controller settings □ 139
76	Process controller - MAX alarm active	TRUE if the controlled variable fed back (in process controller mode) > threshold MAX alarm. Otherwise FALSE. <ul style="list-style-type: none"> Setting of MAX alarm threshold in 0x404D:002 (PAR 608/002). Basic process controller settings □ 139
77	Process controller MIN-MAX alarm active	TRUE if the controlled variable fed back (in process controller mode) < MIN alarm threshold or > MAX alarm threshold. Otherwise FALSE. <ul style="list-style-type: none"> Setting of MIN alarm threshold in 0x404D:001 (PAR 608/001). Setting of MAX alarm threshold in 0x404D:002 (PAR 608/002). Basic process controller settings □ 139
78	Current limit reached	TRUE if current motor current \geq maximum current. Otherwise FALSE. <ul style="list-style-type: none"> Display of the present motor current in 0x2D88 (PAR 104). Setting for the maximum current in 0x6073 (PAR 324).



Flexible I/O configuration

Configuration of digital outputs

Relay

Parameter	Name / value range / [default setting]	Info
	79 Torque limit reached	TRUE if torque limit has been reached or exceeded. Otherwise FALSE.
	80 Follower signal (4 ... 20 mA) lost	TRUE if follower signal (4 ... 20 mA) lower than 2 mA.
	81 Error of analog input 1	TRUE if error detection for analog input 1 has been activated. Otherwise FALSE. The error detection function can be configured via the following parameters: <ul style="list-style-type: none"> Monitoring threshold 0x2636:008 (PAR 430/008) Monitoring condition 0x2636:009 (PAR 430/009) Monitoring response 0x2636:010 (PAR 430/010) ▶ Analog input 1 □ 211
	82 Error of analog input 2	TRUE if error detection for analog input 2 has been activated. Otherwise FALSE. The error detection function can be configured via the following parameters: <ul style="list-style-type: none"> Monitoring threshold 0x2637:008 (PAR 431/008) Monitoring condition 0x2637:009 (PAR 431/009) Monitoring response 0x2637:010 (PAR 431/010) ▶ Analog input 2 □ 213
	83 Load loss	TRUE if current motor current < threshold for load loss detection for at least the delay for load loss detection. Otherwise FALSE. <ul style="list-style-type: none"> Display of the present motor current in 0x6078 (PAR 103). Setting Threshold in 0x4006:001 (PAR 710/001). Setting Deceleration in 0x4006:002 (PAR 710/002). ▶ Load loss detection □ 158
	104 Local control active	TRUE if local keypad control ("LOC") active. Otherwise FALSE.
	105 Remote control active	TRUE if remote control ("REM") via terminals, network, etc. active. Otherwise FALSE.
	106 Manual setpoint selection active	TRUE if manual setpoint selection ("MAN") via keypad active. Otherwise FALSE. <ul style="list-style-type: none"> Selection of the trigger for the "Setpoint = Keypad" function in 0x2631:016 (PAR 400/016).
	107 Automatic setpoint selection active	TRUE if automatic setpoint selection ("AUTO") via terminals, network, etc. active. Otherwise FALSE.
	108 Parameter set 1 active	TRUE if parameter set 1 is loaded and active. Otherwise FALSE.
	109 Parameter set 2 active	TRUE if parameter set 2 is loaded and active. Otherwise FALSE.
	110 Parameter set 3 active	TRUE if parameter set 3 is loaded and active. Otherwise FALSE.
	111 Parameter set 4 active	TRUE if parameter set 4 is loaded and active. Otherwise FALSE.
	112 Loading of parameters successful	TRUE after any parameter set has been loaded. Otherwise FALSE.
	113 Loading of parameters faulty	TRUE if any of the parameter sets could not be loaded. Otherwise FALSE.
	114 Network control mode active	TRUE if the network requests the control. Otherwise FALSE.
	115 Release holding brake	TRUE if the holding brake is released (or should be released). Otherwise FALSE.
0x2635:001 (PAR 421/001)	Inversion of digital outputs: Relay (DO inversion: Relay inverted)	Relay inversion
	0 Not inverted	
	1 Inverted	
0x4018:003	Relay: Cutout delay 0.000 ... [0.020] ... 65.535 s	Switch-off delay for the relay.
0x4018:004	Relay: Switch-on delay 0.000 ... [0.020] ... 65.535 s	Switch-on delay for the relay.
0x4018:005	Relay: Relay state • Read only	Display of the logic state of the relay.
	0 FALSE	
	1 TRUE	
0x4018:006	Relay: Trigger signal state • Read only	Display of the logic state of the trigger signal for the relay (without taking a ON/OFF delay set and inversion into consideration).
	0 FALSE	
	1 TRUE	
0x4018:007	Relay: Switching cycles • Read only	Display of the previous relay switching cycles.

Flexible I/O configuration

Configuration of digital outputs

Digital output 1



11.14.2 Digital output 1

Settings for digital output 1.

Parameter	Name / value range / [default setting]	Info
0x2634:002 (PAR 420/002)	Function assignment of digital outputs: Digital output 1 (Digital outputs: DO1 function) • For possible settings see description for 0x2634:001 (PAR 420/001) . 215	Assignment of a trigger to digital output 1. Trigger = FALSE: X3/DO1 set to LOW level. Trigger = TRUE: X3/DO1 set to HIGH level. Notes: • An inversion set in 0x2635:002 (PAR 421/002) is taken into consideration here.
	115 Release holding brake	TRUE if the holding brake is released (or should be released). Otherwise FALSE.
0x2635:002 (PAR 421/002)	Inversion of digital outputs: Digital output 1 (DO inversion: DO1 inversion)	Inversion of digital output 1
	0 Not inverted 1 Inverted	
0x4016:003	Digital output 1: Cutout delay 0.000 ... [0.020] ... 65.535 s	Switch-off delay for digital output 1.
0x4016:004	Digital output 1: Switch-on delay 0.000 ... [0.020] ... 65.535 s	Switch-on delay for digital output 1.
0x4016:005	Digital output 1: Terminal state • Read only	Display of the logic state of output terminal X3/DO1.
	0 FALSE 1 TRUE	
0x4016:006	Digital output 1: Trigger signal state • Read only	Display of the logic state of the trigger signal for digital output 1 (without taking a ON/OFF delay set and inversion into consideration).
	0 FALSE 1 TRUE	

11.14.3 NETWordOUT1 status word

Assignment of digital triggers to bit 0 ... bit 15 of the NETWordOUT1 status word.

Parameter	Name / value range / [default setting]	Info
0x2634:010 (PAR 420/010)	Function assignment of digital outputs: NETWordOUT1 - bit 0 (Digital outputs: NETWordOUT1.00) • For possible settings see description for 0x2634:001 (PAR 420/001) . 215	Assignment of a trigger to bit 0 of NETWordOUT1. Trigger = FALSE: bit set to 0. Trigger = TRUE: bit set to 1.
	51 Ready for operation	TRUE if operation is enabled AND no error is active. Otherwise FALSE.
0x2634:011 (PAR 420/011)	Function assignment of digital outputs: NETWordOUT1 - bit 1 (Digital outputs: NETWordOUT1.01) • For possible settings see description for 0x2634:001 (PAR 420/001) . 215	Assignment of a trigger to bit 1 of NETWordOUT1. Trigger = FALSE: bit set to 0. Trigger = TRUE: bit set to 1.
	69 Reversal active	TRUE if reversal is active. Otherwise FALSE. • Selection of the trigger for the "Reversal" function in 0x2631:013 (PAR 400/013) .
0x2634:012 (PAR 420/012)	Function assignment of digital outputs: NETWordOUT1 - bit 2 (Digital outputs: NETWordOUT1.02) • For possible settings see description for 0x2634:001 (PAR 420/001) . 215	Assignment of a trigger to bit 2 of NETWordOUT1. Trigger = FALSE: bit set to 0. Trigger = TRUE: bit set to 1.
	50 Running	TRUE if motor is controlled (pulse width modulation on). Otherwise FALSE.
0x2634:013 (PAR 420/013)	Function assignment of digital outputs: NETWordOUT1 - bit 3 (Digital outputs: NETWordOUT1.03) • For possible settings see description for 0x2634:001 (PAR 420/001) . 215	Assignment of a trigger to bit 3 of NETWordOUT1. Trigger = FALSE: bit set to 0. Trigger = TRUE: bit set to 1.
	56 Error active	TRUE if error is active. Otherwise FALSE.



Flexible I/O configuration

Configuration of digital outputs
NETWordOUT1 status word

Parameter	Name / value range / [default setting]	Info
0x2634:014 (PAR 420/014)	Function assignment of digital outputs: NETWordOUT1 - bit 4 (Digital outputs: NETWordOUT1.04) • For possible settings see description for 0x2634:001 (PAR 420/001) . □ 215	Assignment of a trigger to bit 4 of NETWordOUT1. Trigger = FALSE: bit set to 0. Trigger = TRUE: bit set to 1.
	55 Safe torque off (STO) active	TRUE if the integrated safety system has triggered the "Safe torque off" (STO) function. Otherwise FALSE.
0x2634:015 (PAR 420/015)	Function assignment of digital outputs: NETWordOUT1 - bit 5 (Digital outputs: NETWordOUT1.05) • For possible settings see description for 0x2634:001 (PAR 420/001) . □ 215	Assignment of a trigger to bit 5 of NETWordOUT1. Trigger = FALSE: bit set to 0. Trigger = TRUE: bit set to 1.
	54 Quick stop active	TRUE if quick stop is active. Otherwise FALSE. • With the setting "Quick stop ramp -> switch-on inhibited" in 0x605A , the "Quick stop active" status is reset to FALSE after ramp-down to standstill. • With the setting "Quick stop ramp -> quick stop active" in 0x605A , the "quick stop active" status remains TRUE until the "quick stop" function is activated.
0x2634:016 (PAR 420/016)	Function assignment of digital outputs: NETWordOUT1 - bit 6 (Digital outputs: NETWordOUT1.06) • For possible settings see description for 0x2634:001 (PAR 420/001) . □ 215	Assignment of a trigger to bit 6 of NETWordOUT1. Trigger = FALSE: bit set to 0. Trigger = TRUE: bit set to 1.
	71 Actual speed = 0	TRUE if current output frequency = 0 Hz (± 0.01 Hz), irrespective of the operating mode. Otherwise FALSE. • Display of the current output frequency in 0x2DDD (PAR 100) .
0x2634:017 (PAR 420/017)	Function assignment of digital outputs: NETWordOUT1 - bit 7 (Digital outputs: NETWordOUT1.07) • For possible settings see description for 0x2634:001 (PAR 420/001) . □ 215	Assignment of a trigger to bit 7 of NETWordOUT1. Trigger = FALSE: bit set to 0. Trigger = TRUE: bit set to 1.
	58 Device warning active	TRUE if warning is active. Otherwise FALSE. • A warning has no impact on the operating status of the inverter. • A warning is reset automatically if the cause has been eliminated.
0x2634:018 (PAR 420/018)	Function assignment of digital outputs: NETWordOUT1 - bit 8 (Digital outputs: NETWordOUT1.08) • For possible settings see description for 0x2634:001 (PAR 420/001) . □ 215	Assignment of a trigger to bit 8 of NETWordOUT1. Trigger = FALSE: bit set to 0. Trigger = TRUE: bit set to 1.
	115 Release holding brake	TRUE if the holding brake is released (or should be released). Otherwise FALSE.
0x2634:019 (PAR 420/019)	Function assignment of digital outputs: NETWordOUT1 - bit 9 (Digital outputs: NETWordOUT1.09) • For possible settings see description for 0x2634:001 (PAR 420/001) . □ 215	Assignment of a trigger to bit 9 of NETWordOUT1. Trigger = FALSE: bit set to 0. Trigger = TRUE: bit set to 1.
	78 Current limit reached	TRUE if current motor current \geq maximum current. Otherwise FALSE. • Display of the present motor current in 0x2D88 (PAR 104) . • Setting for the maximum current in 0x6073 (PAR 324) .
0x2634:020 (PAR 420/020)	Function assignment of digital outputs: NETWordOUT1 - bit 10 (Digital outputs: NETWordOUT1.10) • For possible settings see description for 0x2634:001 (PAR 420/001) . □ 215	Assignment of a trigger to bit 10 of NETWordOUT1. Trigger = FALSE: bit set to 0. Trigger = TRUE: bit set to 1.
	72 Setpoint speed reached	TRUE if frequency setpoint reached. Otherwise FALSE.
0x2634:021 (PAR 420/021)	Function assignment of digital outputs: NETWordOUT1 - bit 11 (Digital outputs: NETWordOUT1.11) • For possible settings see description for 0x2634:001 (PAR 420/001) . □ 215	Assignment of a trigger to bit 11 of NETWordOUT1. Trigger = FALSE: bit set to 0. Trigger = TRUE: bit set to 1.
	00 Not connected	No trigger assigned (bit is constantly "0").

Flexible I/O configuration

Configuration of digital outputs
NETWordOUT1 status word



Parameter	Name / value range / [default setting]	Info
0x2634:022 (PAR 420/022)	Function assignment of digital outputs: NETWordOUT1 - bit 12 (Digital outputs: NETWordOUT1.12) • For possible settings see description for 0x2634:001 (PAR 420/001) . □ 215	Assignment of a trigger to bit 12 of NETWordOUT1. Trigger = FALSE: bit set to 0. Trigger = TRUE: bit set to 1.
	00 Not connected	No trigger assigned (bit is constantly "0").
0x2634:023 (PAR 420/023)	Function assignment of digital outputs: NETWordOUT1 - bit 13 (Digital outputs: NETWordOUT1.13) • For possible settings see description for 0x2634:001 (PAR 420/001) . □ 215	Assignment of a trigger to bit 13 of NETWordOUT1. Trigger = FALSE: bit set to 0. Trigger = TRUE: bit set to 1.
	00 Not connected	No trigger assigned (bit is constantly "0").
0x2634:024 (PAR 420/024)	Function assignment of digital outputs: NETWordOUT1 - bit 14 (Digital outputs: NETWordOUT1.14) • For possible settings see description for 0x2634:001 (PAR 420/001) . □ 215	Assignment of a trigger to bit 14 of NETWordOUT1. Trigger = FALSE: bit set to 0. Trigger = TRUE: bit set to 1.
	00 Not connected	No trigger assigned (bit is constantly "0").
0x2634:025 (PAR 420/025)	Function assignment of digital outputs: NETWordOUT1 - bit 15 (Digital outputs: NETWordOUT1.15) • For possible settings see description for 0x2634:001 (PAR 420/001) . □ 215	Assignment of a trigger to bit 15 of NETWordOUT1. Trigger = FALSE: bit set to 0. Trigger = TRUE: bit set to 1.
	00 Not connected	No trigger assigned (bit is constantly "0").



11.15 Configuration of analog outputs

11.15.1 Analog output 1

Settings for analog input 1.

Details

- The analog output can be configured as voltage or current source.
- A setting range can be defined for the source signal selected. Source signals outside the setting range are eliminated.

Definition of the setting range

The source signal is converted to a percentage value internally on the basis of the setting range. The reference for the percentage value then is the voltage or current range selected. Example: with a percentage value of the source signal of 60 % and a configuration as 0 ... 10 V voltage source, 6 V are shown at the analog output.

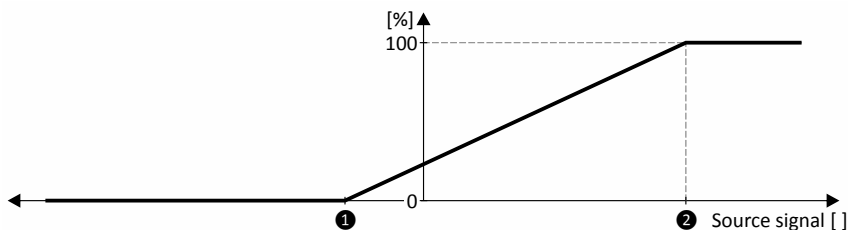

Parameter	Name	Notes
① 0x2639:003 (PAR 440/003)	Min signal value	
② 0x2639:004 (PAR 440/004)	Max signal value	

Parameter	Name / value range / [default setting]	Info
0x2639:001 (PAR 440/001)	Analog output 1: Output range (Analog output 1: AO1 config.)	Definition of the output range.
	0 Inhibited	
	1 0 ... 10 VDC	
	2 0 ... 5 VDC	
	3 2 ... 10 VDC	
	4 4 ... 20 mA	
0x2639:002 (PAR 440/002)	Analog output 1: Function (Analog output 1: AO1 function)	Selection of the signal to be shown at analog output 1.
	0 Not active	No output signal.
	1 Output frequency	Current output frequency [0.1 Hz].
	2 Frequency setpoint	Current frequency setpoint [0.1 Hz].
	3 Analog input 1	Input signal from analog input 1 [0.1 %].
	4 Analog input 2	Input signal from analog input 2 [0.1 %].
	5 Motor current	Present motor current [0.1 A].
	6 Output power	Current output power.
	20 NETWordIN3	Mappable NetWordIN3 data word 0x4008:003 (PAR 590/003).
	21 NETWordIN4	Mappable NetWordIN4 data word 0x4008:004 (PAR 590/004).
	250 Free parameter 1	Free user parameter 1 [16 bits without sign]
251 Free parameter 2	Free user parameter 2 [16 bits with sign]	
252 Free parameter 3	Free user parameter 3 [32 bits without sign]	
253 Free parameter 4	Free user parameter 4 [32 bits with sign]	
0x2639:003 (PAR 440/003)	Analog output 1: Min signal value (Analog output 1: AO1 funct @ min) -2147483648 ... [0] ... 2147483647	Definition of the signal value that corresponds to the minimum value at analog output 1. Example: configuration of analog output 1 as a 4 ... 20 mA current loop: output current 4 mA \equiv 0x2639:003

Flexible I/O configuration

Configuration of analog outputs

Analog output 1



Parameter	Name / value range / [default setting]	Info
0x2639:004 (PAR 440/004)	Analog output 1: Max signal value (Analog output 1: AO1 funct @ max) -2147483648 ... [1000] ... 2147483647	Definition of the signal value that corresponds to the maximum value at analog output 1. Example: configuration of analog output 1 as a 4 ... 20 mA current loop: output current 20 mA \equiv 0x2639:004
0x4008:003 (PAR 590/003)	Process input words: NETWordIN3 (NETWordIN stat: NETWordIN3) 0.0 ... [0.0] ... 100.0 %	Mappable data word for optional control of an analog output via network. Assignment of the analog outputs: <ul style="list-style-type: none">• 0x2639:002 (PAR 440/002) = 20: analog output 1 or• = 20: analog output 2
0x4008:004 (PAR 590/004)	Process input words: NETWordIN4 (NETWordIN stat: NETWordIN4) 0.0 ... [0.0] ... 100.0 %	Mappable data word for optional control of an analog output via network. Assignment of the analog outputs: <ul style="list-style-type: none">• 0x2639:002 (PAR 440/002) = 21: analog output 1 or• = 21: analog output 2



12 Technical data

12.1 Standards and operating conditions

Conformities		
CE	2014/35/EU	Low-Voltage Directive
	2014/30/EU	EMC Directive (reference: CE-typical drive system)
EAC	TR TC 004/2011	Eurasian conformity: Safety of low voltage equipment
	TP TC 020/2011	Eurasian conformity: Electromagnetic compatibility of technical means
RoHS 2	2011/65/EU	Restrictions for the use of specific hazardous materials in electric and electronic devices
Approvals		
UL	UL 61800-5-1	for USA and Canada (requirements of CSA 22.2 No. 274)
Energy efficiency		
Class IE2	EN 50598-2	
Type of protection		
IP20	EN 60529	
Type 1	NEMA 250	Protection against contact
Open type		only for UL approved systems
Insulation resistance		
Overvoltage category III	EN 61800-5-1	0 ... 2000 m a.m.s.l.
Overvoltage category II		above 2000 m a.m.s.l.
Control circuit isolation		
Safe mains isolation by double/reinforced insulation	EN 61800-5-1	
Protective measures against		
Short circuit		
Earth fault		Earth fault strength depends on the operating status
Overvoltage		
Motor stalling		
Motor overtemperature		I ² t monitoring
Leakage current		
> 3.5 mA AC, > 10 mA DC	EN 61800-5-1	Observe regulations and safety instructions!
Mains switching		
3-time mains switching in 1 min		cyclic, without restrictions
Starting current		
≤ 3 x rated mains current		
Mains systems		
TT		Voltage to earth/ground: max. 300 V
TN		
IT		Apply the measures described for IT systems!
		IT systems not relevant for UL approved systems
Operation on public supply systems		
Implement measures to limit the radio interference to be expected:		The compliance with the requirements for the machine/plant is the responsibility of the manufacturer of the machine or plant!
< 0.5 kW: with mains choke	EN 61000-3-2	
0.5 ... 1 kW: With active filter		
> 1 kW at mains current ≤ 16 A: without additional measures		
Mains current > 16 A: with mains choke or mains filter, with dimensioning for rated power. R _{sce} ≥ 120 is to be met.	EN 61000-3-12	R _{sce} : Short-circuit power ratio at the connection point of the machine/plant to the public network.
Requirements to the shielded motor cable		
Capacitance per unit length		
C-core-core/C-core-shield < 75/150 pF/m		≤ 2,5 mm ² / AWG 14
C-core-core/C-core-shield < 150/300 pF/m		≥ 4 mm ² / AWG 12
Electric strength		

Technical data

Standards and operating conditions



U ₀ /U = 0,6/1,0 kV		U = r.m.s. value external conductor/external conductor
U ≥ 600 V	UL	U ₀ = r.m.s. value external conductor to PE
Climate		
1K3 (-25 ... +60 °C)	EN 60721-3-1	Storage
2K3 (-25 ... +70 °C)	EN 60721-3-2	Transport
3K3 (-10 ... +55 °C)	EN 60721-3-3	Operation
		Operation at a switching frequency of 8 or 16 kHz: above +40°C, reduce rated output current by 2.5 %/°C
Site altitude		
0 ... 1000 m a.m.s.l.		
1000 ... 4000 m a.m.s.l.		Reduce rated output current by 5 %/1000 m
Pollution		
Degree of pollution 2	EN 61800-5-1	
Vibration resistance		
Transport		
2M2 (sine, shock)	EN 60721-3-2	
Operation		
Amplitude 1 mm	Germanischer Lloyd	5 ... 13.2 Hz
acceleration resistant up to 0.7 g		13.2 ... 100 Hz
Amplitude 0.075 mm	EN 61800-5-1	10 ... 57 Hz
acceleration resistant up to 1 g		57 ... 150 Hz
Noise emission		
Category C2	EN 61800-3	type-dependent, for motor cable lengths see rated data
Noise immunity		
Meets requirement in compliance with	EN 61800-3	



12.2 Rated data

12.2.1 Connection to the 230 V system

Inverter		I51AE125B	I51AE137B	I51AE155B	I51AE175B	I51AE211B	I51AE215B	I51AE222B
Rated power	kW	0.25	0.37	0.55	0.75	1.1	1.5	2.2
Mains voltage range		1/N/PE AC 170 V ... 264 V, 45 Hz ... 65 Hz						
Operating mode		S1						
Max. surrounding air temperature	°C	40						
Switching frequency	kHz	4						
Rated mains current								
without mains choke	A	4	5.7	7.6	10	14.3	16.7	22.5
with mains choke	A	3.6	4.8	7.1	8.8	11.9	13.9	16.9
Rated output current	A	1.7	2.4	3.2	4.2	6	7	9.6
Motor cable length								
C2 residential area / industrial premises	m	15			20			
Weight	kg	0.75		0.95		1.35		

12.2.2 Connection to the 400 V system

Inverter		I51AE137F	I51AE155F	I51AE175F	I51AE211F	I51AE215F	I51AE222F
Rated power	kW	0.37	0.55	0.75	1.1	1.5	2.2
Mains voltage range		3/N/PE AC 340 V ... 528 V, 45 Hz ... 65 Hz					
Operating mode		S1					
Max. surrounding air temperature	°C	40					
Switching frequency	kHz	4					
Rated mains current							
without mains choke	A	1.8	2.5	3.3	4.4	5.4	7.8
with mains choke	A	1.4	2	2.6	3	3.7	5.3
Rated output current	A	1.3	1.8	2.4	3.2	3.9	5.6
Motor cable length							
C2 residential area / industrial premises	m	15			20		
Weight	kg	0.75	0.95		1.35		

Appendix

Changing the parameter settings using the keypad



13 Appendix

13.1 Changing the parameter settings using the keypad

Keypad operating mode

After switching on the inverter, the keypad plugged in is in "Operating mode" after a short initialisation phase.

In the operating mode,

- the keypad can be used for local control and for manual setpoint selection.
- the keypad displays some information on the inverter status (see the following table).

Meaning of the keypad status displays

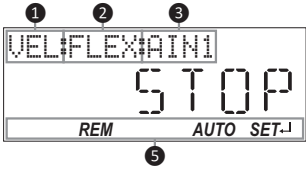
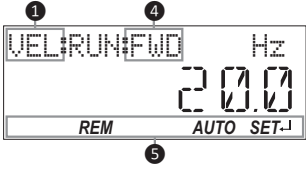
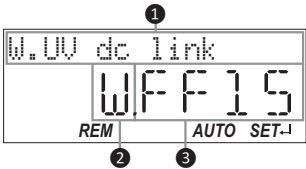
Keypad display	Display	Meaning
<p>If the inverter is inhibited, the keypad shows "STOP":</p> 	<p>① Active control mode:</p>	<p>VEL Speed mode</p> <p>PID Process controller mode</p> <p>TRQ Torque mode</p> <p>TSTx Test mode x</p> <p>JOG Manual mode</p>
<p>If the inverter is enabled, the keypad shows the output frequency of the inverter:</p> 	<p>② Active control source:</p>	<p>FLEX Flexible I/O configuration</p> <p>KPD Keypad</p> <p>NET Network</p> <p>TSTx Test mode x</p>
<ul style="list-style-type: none"> • In PID mode, instead of the output frequency the PID setpoint is shown. • The display can be configured in 0x2864 (PAR 703). 	<p>③ Active setpoint source:</p>	<p>AINx Analog input x</p> <p>KPD Keypad</p> <p>NET Network</p> <p>FREQ Digital frequency</p> <p>PRx Preset setpoint x</p> <p>SEGx Segment x</p> <p>MOP Motor potentiometer</p>
<p>If a fault is pending, the keypad shows the following information:</p> 	<p>④ Current direction of rotation:</p>	<p>FWD Motor is rotating forwards</p> <p>REV Motor is rotating backwards</p>
<ul style="list-style-type: none"> • Warnings (W) are only displayed every 2 seconds for a short time. • Trouble (T) and faults (F) are displayed continuously. 	<p>⑤ Lower status line:</p>	<p>LOC Local keypad control active.</p> <p>REM Remote control via terminals, network, etc. active.</p> <p>MAN Manual setpoint selection via keypad active.</p> <p>AUTO Automatic setpoint selection via terminals, network, etc. active.</p> <p>SET Blinking if one parameter setting has been changed but has not been saved in the memory module with mains failure protection. Save settings: press keypad "Enter" key > 3 s.</p>
	<p>① Message text</p>	
	<p>② Response:</p>	<p>W Warning</p> <p>T Trouble</p> <p>F Fault</p>
	<p>③ Error code</p>	

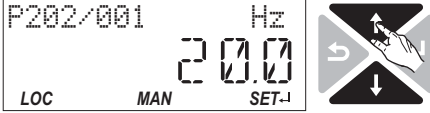

Function of the keypad keys in operating mode

Keypad display	Key	Function
Example: changing the speed setpoint while the inverter is inhibited: 1. 	ⓘ	If local keypad control ("LOC" display) active: start inverter. If remote control ("REM" display) active: cancel stop ("KSTOP" display) triggered via keypad again. The inverter remains stopped ("STOP" display).
	⊙	Stop inverter.
2. 	↶	Change to parameterisation mode. See section " Keypad parameterisation mode ".
	↑	Manual setpoint selection via keypad ("MAN" display) active: 1. Change to display and setting of the frequency setpoint.
	↓	2. Increase or reduce frequency setpoint.

Keypad parameterisation mode

In the parameterisation mode of the keypad you can have actual values of the inverter displayed for purposes of diagnostics and change settings of the inverter.

- In order to provide for quick access, all parameters of the inverter are divided into different groups according to their function.
- Group 0 contains the configurable "Favorites". In the default setting these are the most common parameters for the solution of typical applications. ▶ [Favorites](#) □ 162
- By the hundreds digit of the PAR number (PAR Xxx) you can quickly see in which group the parameter is to be found on the keypad:



Group/name	Parameter	Description
Group 1 - Diagnostics	PAR 1xx	Diagnostic/display parameters for displaying device-internal process factors, current actual values, and status messages. ▶ Diagnostics □ 44
Group 2 - basic setting	PAR 2xx	Setting of the mains voltage, selection of the control and setpoint source, starting and stopping performance, frequency limits and ramp times. ▶ Basic setting □ 66
Group 3 - Motor Control	PAR 3xx	Configuration of the motor and motor control ▶ Motor control □ 77
Group 4 - I/O setting	PAR 4xx	Function assignment and configuration of the inputs and outputs ▶ Flexible I/O configuration □ 186
Group 5 - network setting	PAR 5xx	Configuration of the network (if available) ▶ Configuring the network □ 96
Group 6 - Process Controller	PAR 6xx	Configuration of the process controller ▶ Configuring the process controller □ 138
Group 7 - Additional Functions	PAR 7xx	Parameterisable additional functions ▶ Additional functions □ 144

Appendix

Changing the parameter settings using the keypad

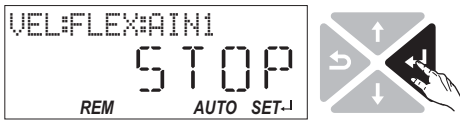
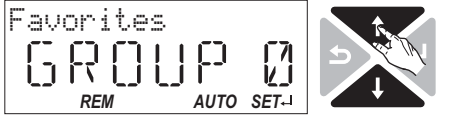
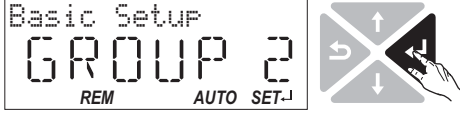
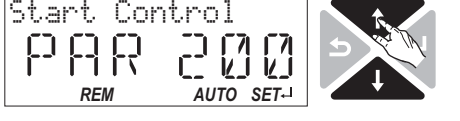
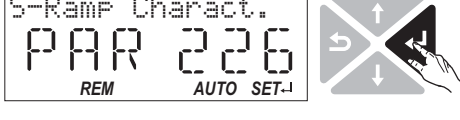
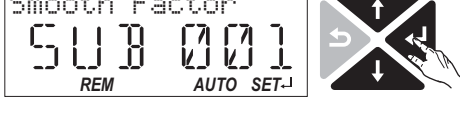

Changing inverter settings by means of the keypad (general operation)

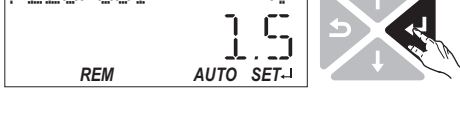
1. 
2. 
3. 
4. 
5. 
6. 
7. 
8. 

1. Use the \leftarrow key in the operating mode to navigate to the parameterisation mode one level below.
You are now in the group level.
Note: By using the \rightarrow key you can navigate one level upwards again anytime.
2. Use the \uparrow and \downarrow navigation keys to select the desired group.
3. Use the \leftarrow key to navigate to one level below.
You are now in the parameter level of the group selected.
4. Use the \uparrow and \downarrow navigation keys to select the desired parameter.
5. Use the \leftarrow key to navigate to one level below.
If the parameter does not contain any subindexes, you are now in the editing mode (continue with step 7). Otherwise you are in the SUB parameter level.
6. If the parameter contains subindexes:
 - a) Use the \uparrow and \downarrow navigation keys to select the desired subindex.
 - b) Use the \leftarrow key to navigate to one level below.
You are now in the editing mode.
7. Set the desired value using the \uparrow and \downarrow navigation keys.
8. Use the \leftarrow key to accept the changed setting.
The editing mode is exited.
Note: By using the \rightarrow key you can exit the editing mode without accepting the new setting (abort).



The SET display is blinking if a parameter setting has been changed but has not been saved in the memory module with mains failure protection. In order to save parameter settings in the user memory of the memory module, press the keypad "Enter" key > 3 s.



13.2 Parameter attribute list

The parameter attribute list in particular contains some information required for reading and writing parameters via network.

- The parameter attribute list contains all parameters of the inverter.
- The parameter attribute list is sorted by addresses (index:subindex) in ascending order.

How to read the parameter attribute list:

Column	Meaning																																																				
Address	Address of the parameter in the object directory. Format: <i>index[:subindex]</i> If available: display code (parameter designation on the keypad). Format: (PAR number)																																																				
Name	Parameter short text (display text)																																																				
Default setting	Default setting of the parameter																																																				
D / F / A / M	<p>D = data type of the parameter:</p> <table border="1"> <tr><td>I8</td><td>1 byte, with sign</td></tr> <tr><td>I16</td><td>2 bytes with sign</td></tr> <tr><td>I32</td><td>4 bytes with sign</td></tr> <tr><td>I64</td><td>8 bytes with sign</td></tr> <tr><td>U8</td><td>1 byte without sign</td></tr> <tr><td>U16</td><td>2 bytes without sign</td></tr> <tr><td>U32</td><td>4 bytes without sign</td></tr> <tr><td>U64</td><td>8 bytes without sign</td></tr> <tr><td>REAL32</td><td>4 bytes floating point</td></tr> <tr><td>STRING[xx]</td><td>ASCII string (with character length xx)</td></tr> <tr><td>OCTET[xx]</td><td>OCTET string (with xx bytes)</td></tr> <tr><td>L_INDEX</td><td>4 bytes without sign. Is used specially for addressing Lenze parameters.</td></tr> </table> <p>F = factor for data transmission via network, depending on the number of decimal positions.</p> <ul style="list-style-type: none"> • The integer value read via network must be divided by the corresponding factor in order to receive the actual display value. • The actual setting value must be multiplied with the corresponding factor in order to receive the integer value to be written via network. <table border="1"> <tr><td>1</td><td>No decimal positions</td></tr> <tr><td>10</td><td>1 decimal position</td></tr> <tr><td>100</td><td>2 decimal positions</td></tr> <tr><td>1000</td><td>3 decimal positions</td></tr> <tr><td>10000</td><td>4 decimal positions</td></tr> </table> <p>A = attributes (combinations of several attributes also possible):</p> <table border="1"> <tr><td>C</td><td>Writing is only possible if the controller is inhibited</td></tr> <tr><td>E</td><td>Value is displayed as IP address on the keypad</td></tr> <tr><td>H</td><td>Value is displayed as hexadecimal value on the keypad</td></tr> <tr><td>K</td><td>Parameter is only shown on the keypad</td></tr> <tr><td>P</td><td>Setting is saved in the memory module</td></tr> <tr><td>X</td><td>Hidden parameter: only accessible if a password is set.</td></tr> </table> <p>M = Mapping:</p> <table border="1"> <tr><td>r</td><td>Receive mapping permissible</td></tr> <tr><td>t</td><td>Transmit mapping permissible</td></tr> <tr><td>rt</td><td>Receive and transmit mapping permissible</td></tr> </table>	I8	1 byte, with sign	I16	2 bytes with sign	I32	4 bytes with sign	I64	8 bytes with sign	U8	1 byte without sign	U16	2 bytes without sign	U32	4 bytes without sign	U64	8 bytes without sign	REAL32	4 bytes floating point	STRING[xx]	ASCII string (with character length xx)	OCTET[xx]	OCTET string (with xx bytes)	L_INDEX	4 bytes without sign. Is used specially for addressing Lenze parameters.	1	No decimal positions	10	1 decimal position	100	2 decimal positions	1000	3 decimal positions	10000	4 decimal positions	C	Writing is only possible if the controller is inhibited	E	Value is displayed as IP address on the keypad	H	Value is displayed as hexadecimal value on the keypad	K	Parameter is only shown on the keypad	P	Setting is saved in the memory module	X	Hidden parameter: only accessible if a password is set.	r	Receive mapping permissible	t	Transmit mapping permissible	rt	Receive and transmit mapping permissible
I8	1 byte, with sign																																																				
I16	2 bytes with sign																																																				
I32	4 bytes with sign																																																				
I64	8 bytes with sign																																																				
U8	1 byte without sign																																																				
U16	2 bytes without sign																																																				
U32	4 bytes without sign																																																				
U64	8 bytes without sign																																																				
REAL32	4 bytes floating point																																																				
STRING[xx]	ASCII string (with character length xx)																																																				
OCTET[xx]	OCTET string (with xx bytes)																																																				
L_INDEX	4 bytes without sign. Is used specially for addressing Lenze parameters.																																																				
1	No decimal positions																																																				
10	1 decimal position																																																				
100	2 decimal positions																																																				
1000	3 decimal positions																																																				
10000	4 decimal positions																																																				
C	Writing is only possible if the controller is inhibited																																																				
E	Value is displayed as IP address on the keypad																																																				
H	Value is displayed as hexadecimal value on the keypad																																																				
K	Parameter is only shown on the keypad																																																				
P	Setting is saved in the memory module																																																				
X	Hidden parameter: only accessible if a password is set.																																																				
r	Receive mapping permissible																																																				
t	Transmit mapping permissible																																																				
rt	Receive and transmit mapping permissible																																																				

Parameter attribute list (short overview of all parameter indexes)

Address	Name / Subindex: Name	Default setting	Setting range	D / F / A / M
0x1000	Device type	-	- (Read only)	U32 / 1 / H / -
0x1001	Error register	-	- (Read only)	U8 / 1 / H / t
0x1005	COB-ID SYNC	0x00000080	0x00000000 ... 0xFFFFFFFF	U32 / 1 / PH / -
0x1006	Communication cyclic period	0 us	0 ... 65535000 us	U32 / 1 / P / -
0x1008	Manufacturer's device name	-	- (Read only)	STRING[50] / 1 / - / -
0x1009	Manufacturer hardware version	-	- (Read only)	STRING[50] / 1 / - / -
0x100A	Manufacturer software version	-	- (Read only)	STRING[50] / 1 / - / -

* Default setting depending on the size. Firmware-Version 01.01.01.00

Appendix

Parameter attribute list



Address	Name / Subindex: Name	Default setting	Setting range	D / F / A / M
0x1014	COB-ID EMCY	-	- (Read only)	U32 / 1 / H / -
0x1015	Inhibit time EMCY	0.0 ms	0.0 ... 6553.5 ms	U16 / 10 / P / -
0x1016	Consumer heartbeat time			
	000: Highest subindex	-	- (Read only)	U8 / 1 / - / -
	001: Node 1	0x00000000	0x00000000 ... 0x00FFFFFF	U32 / 1 / PH / -
	002: Node 2	0x00000000	0x00000000 ... 0x00FFFFFF	U32 / 1 / PH / -
	003: Node 3	0x00000000	0x00000000 ... 0x00FFFFFF	U32 / 1 / PH / -
	004: Node 4	0x00000000	0x00000000 ... 0x00FFFFFF	U32 / 1 / PH / -
0x1017	Producer heartbeat time	0 ms	0 ... 65535 ms	U16 / 1 / P / -
0x1018	Identity object			
	001: Supplier ID	-	- (Read only)	U32 / 1 / - / -
	002: Product code	-	- (Read only)	U32 / 1 / H / -
	003: Revision	-	- (Read only)	U32 / 1 / - / -
	004: Serial number	-	- (Read only)	U32 / 1 / - / -
0x1029	Error behavior			
	000: Highest subindex	-	- (Read only)	U8 / 1 / - / -
	001: Communication error	Status -> Pre-operational [0]	Selection list	U8 / 1 / P / -
0x1200	SDO1 server parameter			
	000: Highest subindex	-	- (Read only)	U8 / 1 / - / -
	001: COB-ID client -> server (RX)	-	- (Read only)	U32 / 1 / H / -
	002: COB-ID server -> client (TX)	-	- (Read only)	U32 / 1 / H / -
0x1201	SDO2 server parameter			
	000: Highest subindex	-	- (Read only)	U8 / 1 / - / -
	001: COB-ID client -> server (RX)	0x80000640	0x00000000 ... 0xFFFFFFFF	U32 / 1 / PH / -
	002: COB-ID server -> client (TX)	0x800005C0	0x00000000 ... 0xFFFFFFFF	U32 / 1 / PH / -
	003: SDO client node ID	0	1 ... 127	U8 / 1 / P / -
0x1400	RPDO1 communication parameter			
	000: Highest subindex	-	- (Read only)	U8 / 1 / - / -
	001: COB-ID	0x00000200	0x00000000 ... 0xFFFFFFFF	U32 / 1 / PH / -
	002: Transmission type	255	0 ... 255	U8 / 1 / P / -
	005: Event timer	100 ms	0 ... 65535 ms	U16 / 1 / P / -
0x1401	RPDO2 communication parameter			
	001: COB-ID	0x80000300	0x00000000 ... 0xFFFFFFFF	U32 / 1 / PH / -
	002: Transmission type	255	0 ... 255	U8 / 1 / P / -
	005: Event timer	100 ms	0 ... 65535 ms	U16 / 1 / P / -
0x1402	RPDO3 communication parameter			
	001: COB-ID	0x80000400	0x00000000 ... 0xFFFFFFFF	U32 / 1 / PH / -
	002: Transmission type	255	0 ... 255	U8 / 1 / P / -
	005: Event timer	100 ms	0 ... 65535 ms	U16 / 1 / P / -
0x1600	RPDO1 mapping parameter			
	000: Highest subindex	2	0 ... 8	U8 / 1 / P / -
	001: Entry 1	0x60400010	0x00000000 ... 0xFFFFFFFF	U32 / 1 / PH / -
	002: Entry 2	0x60420010	0x00000000 ... 0xFFFFFFFF	U32 / 1 / PH / -
	003: Entry 3	0x00000000	0x00000000 ... 0xFFFFFFFF	U32 / 1 / PH / -
	004: Entry 4	0x00000000	0x00000000 ... 0xFFFFFFFF	U32 / 1 / PH / -
	005: Entry 5	0x00000000	0x00000000 ... 0xFFFFFFFF	U32 / 1 / PH / -
	006: Entry 6	0x00000000	0x00000000 ... 0xFFFFFFFF	U32 / 1 / PH / -
	007: Entry 7	0x00000000	0x00000000 ... 0xFFFFFFFF	U32 / 1 / PH / -
	008: Entry 8	0x00000000	0x00000000 ... 0xFFFFFFFF	U32 / 1 / PH / -
0x1601	RPDO2 mapping parameter			
	000: Highest subindex	0	0 ... 8	U8 / 1 / P / -
	001: Entry 1	0x00000000	0x00000000 ... 0xFFFFFFFF	U32 / 1 / PH / -
	002: Entry 2	0x00000000	0x00000000 ... 0xFFFFFFFF	U32 / 1 / PH / -

* Default setting depending on the size.

Firmware-Version 01.01.01.00



Appendix

Parameter attribute list

Address	Name / Subindex: Name	Default setting	Setting range	D / F / A / M
	003: Entry 3	0x00000000	0x00000000 ... 0xFFFFFFFF	U32 / 1 / PH / -
	004: Entry 4	0x00000000	0x00000000 ... 0xFFFFFFFF	U32 / 1 / PH / -
	005: Entry 5	0x00000000	0x00000000 ... 0xFFFFFFFF	U32 / 1 / PH / -
	006: Entry 6	0x00000000	0x00000000 ... 0xFFFFFFFF	U32 / 1 / PH / -
	007: Entry 7	0x00000000	0x00000000 ... 0xFFFFFFFF	U32 / 1 / PH / -
	008: Entry 8	0x00000000	0x00000000 ... 0xFFFFFFFF	U32 / 1 / PH / -
0x1602	RPDO3 mapping parameter			
	000: Highest subindex	0	0 ... 8	U8 / 1 / P / -
	001: Entry 1	0x00000000	0x00000000 ... 0xFFFFFFFF	U32 / 1 / PH / -
	002: Entry 2	0x00000000	0x00000000 ... 0xFFFFFFFF	U32 / 1 / PH / -
	003: Entry 3	0x00000000	0x00000000 ... 0xFFFFFFFF	U32 / 1 / PH / -
	004: Entry 4	0x00000000	0x00000000 ... 0xFFFFFFFF	U32 / 1 / PH / -
	005: Entry 5	0x00000000	0x00000000 ... 0xFFFFFFFF	U32 / 1 / PH / -
	006: Entry 6	0x00000000	0x00000000 ... 0xFFFFFFFF	U32 / 1 / PH / -
	007: Entry 7	0x00000000	0x00000000 ... 0xFFFFFFFF	U32 / 1 / PH / -
	008: Entry 8	0x00000000	0x00000000 ... 0xFFFFFFFF	U32 / 1 / PH / -
0x1800	TPDO1 communication parameter			
	000: Highest subindex	-	- (Read only)	U8 / 1 / - / -
	001: COB-ID	0x40000180	0x00000001 ... 0xFFFFFFFF	U32 / 1 / PH / -
	002: Transmission type	255	0 ... 255	U8 / 1 / P / -
	003: Inhibit time	0.0 ms	0.0 ... 6553.5 ms	U16 / 10 / P / -
	005: Event timer	20 ms	0 ... 65535 ms	U16 / 1 / P / -
0x1801	TPDO2 communication parameter			
	000: Highest subindex	-	- (Read only)	U8 / 1 / - / -
	001: COB-ID	0xC0000280	0x00000001 ... 0xFFFFFFFF	U32 / 1 / PH / -
	002: Transmission type	255	0 ... 255	U8 / 1 / P / -
	003: Inhibit time	0.0 ms	0.0 ... 6553.5 ms	U16 / 10 / P / -
	005: Event timer	0 ms	0 ... 65535 ms	U16 / 1 / P / -
0x1802	TPDO3 communication parameter			
	000: Highest subindex	-	- (Read only)	U8 / 1 / - / -
	001: COB-ID	0xC0000380	0x00000001 ... 0xFFFFFFFF	U32 / 1 / PH / -
	002: Transmission type	255	0 ... 255	U8 / 1 / P / -
	003: Inhibit time	0.0 ms	0.0 ... 6553.5 ms	U16 / 10 / P / -
	005: Event timer	0 ms	0 ... 65535 ms	U16 / 1 / P / -
0x1A00	TPDO1 mapping parameter			
	000: Highest subindex	2	0 ... 8	U8 / 1 / P / -
	001: Entry 1	0x60410010	0x00000000 ... 0xFFFFFFFF	U32 / 1 / PH / -
	002: Entry 2	0x60440010	0x00000000 ... 0xFFFFFFFF	U32 / 1 / PH / -
	003: Entry 3	0x00000000	0x00000000 ... 0xFFFFFFFF	U32 / 1 / PH / -
	004: Entry 4	0x00000000	0x00000000 ... 0xFFFFFFFF	U32 / 1 / PH / -
	005: Entry 5	0x00000000	0x00000000 ... 0xFFFFFFFF	U32 / 1 / PH / -
	006: Entry 6	0x00000000	0x00000000 ... 0xFFFFFFFF	U32 / 1 / PH / -
	007: Entry 7	0x00000000	0x00000000 ... 0xFFFFFFFF	U32 / 1 / PH / -
	008: Entry 8	0x00000000	0x00000000 ... 0xFFFFFFFF	U32 / 1 / PH / -
0x1A01	TPDO2 mapping parameter			
	000: Highest subindex	0	0 ... 8	U8 / 1 / P / -
	001: Entry 1	0x00000000	0x00000000 ... 0xFFFFFFFF	U32 / 1 / PH / -
	002: Entry 2	0x00000000	0x00000000 ... 0xFFFFFFFF	U32 / 1 / PH / -
	003: Entry 3	0x00000000	0x00000000 ... 0xFFFFFFFF	U32 / 1 / PH / -
	004: Entry 4	0x00000000	0x00000000 ... 0xFFFFFFFF	U32 / 1 / PH / -
	005: Entry 5	0x00000000	0x00000000 ... 0xFFFFFFFF	U32 / 1 / PH / -
	006: Entry 6	0x00000000	0x00000000 ... 0xFFFFFFFF	U32 / 1 / PH / -
	007: Entry 7	0x00000000	0x00000000 ... 0xFFFFFFFF	U32 / 1 / PH / -
	008: Entry 8	0x00000000	0x00000000 ... 0xFFFFFFFF	U32 / 1 / PH / -

* Default setting depending on the size.

Firmware-Version 01.01.01.00

Appendix

Parameter attribute list



Address	Name / Subindex: Name	Default setting	Setting range	D / F / A / M	
0x1A02	TPDO3 mapping parameter				
	000: Highest subindex	0	0 ... 8	U8 / 1 / P / -	
	001: Entry 1	0x00000000	0x00000000 ... 0xFFFFFFFF	U32 / 1 / PH / -	
	002: Entry 2	0x00000000	0x00000000 ... 0xFFFFFFFF	U32 / 1 / PH / -	
	003: Entry 3	0x00000000	0x00000000 ... 0xFFFFFFFF	U32 / 1 / PH / -	
	004: Entry 4	0x00000000	0x00000000 ... 0xFFFFFFFF	U32 / 1 / PH / -	
	005: Entry 5	0x00000000	0x00000000 ... 0xFFFFFFFF	U32 / 1 / PH / -	
	006: Entry 6	0x00000000	0x00000000 ... 0xFFFFFFFF	U32 / 1 / PH / -	
	007: Entry 7	0x00000000	0x00000000 ... 0xFFFFFFFF	U32 / 1 / PH / -	
0x2000	001: Product code	-	- (Read only)	STRING[18] / 1 / - / -	
	002: Serial number	-	- (Read only)	STRING[50] / 1 / - / -	
	004: Control unit - firmware version	-	- (Read only)	STRING[50] / 1 / - / -	
	005: Control unit - firmware type	-	- (Read only)	STRING[50] / 1 / - / -	
	006: Control unit - bootloader version	-	- (Read only)	STRING[50] / 1 / - / -	
	007: Control unit - bootloader type	-	- (Read only)	STRING[50] / 1 / - / -	
	008: Object directory version	-	- (Read only)	U32 / 1 / - / -	
	010: Power unit - firmware version	-	- (Read only)	STRING[50] / 1 / - / -	
	011: Power unit - firmware type	-	- (Read only)	STRING[50] / 1 / - / -	
	012: Power unit - bootloader version	-	- (Read only)	STRING[50] / 1 / - / -	
	013: Power unit - bootloader type	-	- (Read only)	STRING[50] / 1 / - / -	
	0x2001	Device name	My Device	Text	STRING[128] / 1 / PK / -
	0x2006	Error history buffer			
000: Keypad display		-	- (Read only)	U8 / 1 / - / -	
001: Maximum number of messages		-	- (Read only)	U8 / 1 / - / -	
002: Latest message		-	- (Read only)	U8 / 1 / - / -	
003: Latest acknowledgement message		1	0 ... 1	U8 / 1 / - / -	
004: New message		-	- (Read only)	U8 / 1 / - / t	
005: Buffer overflow		-	- (Read only)	U16 / 1 / - / -	
006: Message 0		-	- (Read only)	OCTET[19] / 1 / - / -	
007: Message 1		-	- (Read only)	OCTET[19] / 1 / - / -	
008: Message 2		-	- (Read only)	OCTET[19] / 1 / - / -	
009: Message 3		-	- (Read only)	OCTET[19] / 1 / - / -	
010: Message 4		-	- (Read only)	OCTET[19] / 1 / - / -	
011: Message 5		-	- (Read only)	OCTET[19] / 1 / - / -	
012: Message 6		-	- (Read only)	OCTET[19] / 1 / - / -	
013: Message 7		-	- (Read only)	OCTET[19] / 1 / - / -	
014: Message 8		-	- (Read only)	OCTET[19] / 1 / - / -	
015: Message 9		-	- (Read only)	OCTET[19] / 1 / - / -	
016: Message 10		-	- (Read only)	OCTET[19] / 1 / - / -	
017: Message 11		-	- (Read only)	OCTET[19] / 1 / - / -	
018: Message 12		-	- (Read only)	OCTET[19] / 1 / - / -	
019: Message 13		-	- (Read only)	OCTET[19] / 1 / - / -	
020: Message 14		-	- (Read only)	OCTET[19] / 1 / - / -	
021: Message 15		-	- (Read only)	OCTET[19] / 1 / - / -	
022: Message 16		-	- (Read only)	OCTET[19] / 1 / - / -	
023: Message 17		-	- (Read only)	OCTET[19] / 1 / - / -	
024: Message 18		-	- (Read only)	OCTET[19] / 1 / - / -	
025: Message 19		-	- (Read only)	OCTET[19] / 1 / - / -	
026: Message 20		-	- (Read only)	OCTET[19] / 1 / - / -	
027: Message 21		-	- (Read only)	OCTET[19] / 1 / - / -	
028: Message 22		-	- (Read only)	OCTET[19] / 1 / - / -	
029: Message 23		-	- (Read only)	OCTET[19] / 1 / - / -	
030: Message 24	-	- (Read only)	OCTET[19] / 1 / - / -		

* Default setting depending on the size.

Firmware-Version 01.01.01.00



Appendix

Parameter attribute list

Address	Name / Subindex: Name	Default setting	Setting range	D / F / A / M
	031: Message 25	-	- (Read only)	OCTET[19] / 1 / - / -
	032: Message 26	-	- (Read only)	OCTET[19] / 1 / - / -
	033: Message 27	-	- (Read only)	OCTET[19] / 1 / - / -
	034: Message 28	-	- (Read only)	OCTET[19] / 1 / - / -
	035: Message 29	-	- (Read only)	OCTET[19] / 1 / - / -
	036: Message 30	-	- (Read only)	OCTET[19] / 1 / - / -
	037: Message 31	-	- (Read only)	OCTET[19] / 1 / - / -
0x2021	Optical device identification			
	001: Start detection	Stop [0]	Selection list	U8 / 1 / - / -
	002: Blinking duration	5 s	0 ... 3600 s	U16 / 1 / - / -
0x2022	Device commands			
	001: Load Lenze settings	Off / ready [0]	Selection list	U8 / 1 / CX / -
	003: Save data in the user memory	Off / ready [0]	Selection list	U8 / 1 / X / -
	004: Load data from the user memory	Off / ready [0]	Selection list	U8 / 1 / CX / -
	005: Load data from the OEM memory	Off / ready [0]	Selection list	U8 / 1 / CX / -
	006: Save data in the OEM memory	Off / ready [0]	Selection list	U8 / 1 / X / -
	007: Load parameter set 1	Off / ready [0]	Selection list	U8 / 1 / X / -
	008: Load parameter set 2	Off / ready [0]	Selection list	U8 / 1 / X / -
	009: Load parameter set 3	Off / ready [0]	Selection list	U8 / 1 / X / -
	010: Load parameter set 4	Off / ready [0]	Selection list	U8 / 1 / X / -
	011: Save parameter set 1	Off / ready [0]	Selection list	U8 / 1 / X / -
	012: Save parameter set 2	Off / ready [0]	Selection list	U8 / 1 / X / -
	013: Save parameter set 3	Off / ready [0]	Selection list	U8 / 1 / X / -
	014: Save parameter set 4	Off / ready [0]	Selection list	U8 / 1 / X / -
	015: Delete logbook	0	0 ... 1	U8 / 1 / CX / -
	016: Reset network node	0	0 ... 1	U8 / 1 / CX / -
	026: Updating the memory module data format	0	0 ... 1	U8 / 1 / CX / -
	027: Accept new inverter hardware	0	0 ... 1	U8 / 1 / CX / -
	032: Deactivate PDO Communication	Off / ready [0]	Selection list	U8 / 1 / X / -
	033: Activate PDO Communication	Off / ready [0]	Selection list	U8 / 1 / X / -
0x2030	CRC parameter set	-	- (Read only)	U32 / 1 / - / -
0x203D	PIN1 access protection	0	-1 ... 9999	I16 / 1 / - / -
0x203E	PIN2 access protection	0	-1 ... 9999	I16 / 1 / - / -
0x203F	PIN1/PIN2 log-in	0	-32768 ... 32767	I16 / 1 / - / -
0x2040	Access protection status	-	- (Read only)	U16 / 1 / - / -
0x2300	Activate network	No action/no error [0]	Selection list	U8 / 1 / C / -
0x2301	CANopen settings			
	001: Node ID	1	1 ... 127	U8 / 1 / P / -
	002: Baud rate	500 kbps [5]	Selection list	U8 / 1 / P / -
	003: Slave/Master	Slave [0]	Selection list	U8 / 1 / P / -
	004: Start of remote deceleration	3000 ms	0 ... 65535 ms	U16 / 1 / P / -
	005: Activate SDO2 channel	Not active [0]	Selection list	U8 / 1 / - / -
0x2302	Active CANopen settings			
	001: Node ID	-	- (Read only)	U8 / 1 / - / -
	002: Baud rate	-	- (Read only)	U8 / 1 / - / -
0x2303	DIP switch position	-	- (Read only)	U16 / 1 / - / -
0x2307	CANopen time-out status	-	- (Read only)	U32 / 1 / - / -
0x2308	CANopen status	-	- (Read only)	U16 / 1 / - / -
0x2309	CANopen controller status	-	- (Read only)	U16 / 1 / - / -
0x230A	CANopen statistics			
	000: Highest subindex	-	- (Read only)	U8 / 1 / - / -
	001: PDO1 received	-	- (Read only)	U16 / 1 / - / -
	002: PDO2 received	-	- (Read only)	U16 / 1 / - / -
	003: PDO3 received	-	- (Read only)	U16 / 1 / - / -

* Default setting depending on the size.

Firmware-Version 01.01.01.00

Appendix

Parameter attribute list

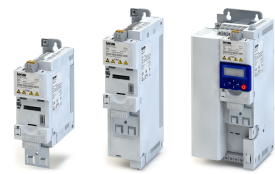

Address	Name / Subindex: Name	Default setting	Setting range	D / F / A / M
	005: PDO1 transmitted	-	- (Read only)	U16 / 1 / - / -
	006: PDO2 transmitted	-	- (Read only)	U16 / 1 / - / -
	007: PDO3 transmitted	-	- (Read only)	U16 / 1 / - / -
	009: SDO1 telegrams	-	- (Read only)	U16 / 1 / - / -
	010: SDO2 telegrams	-	- (Read only)	U16 / 1 / - / -
0x230B	CANopen error counter	-	- (Read only)	U16 / 1 / - / -
0x231F	Module ID			
	001: Active module ID	-	- (Read only)	U8 / 1 / P / -
	002: Module ID connected	-	- (Read only)	U8 / 1 / - / -
0x2320	Activate Modbus network	0	0 ... 1	U8 / 1 / X / -
0x2321	Modbus settings			
	001: Node ID	1	1 ... 247	U8 / 1 / P / -
	002: Baud rate	Automatic [0]	Selection list	U8 / 1 / P / -
	003: Data format	Automatic [0]	Selection list	U8 / 1 / P / -
	004: Minimum response time	0 ms	0 ... 1000 ms	U16 / 1 / P / -
0x2322	Active Modbus settings			
	001: Node ID	-	- (Read only)	U8 / 1 / X / -
	002: Baud rate	-	- (Read only)	U8 / 1 / X / -
	003: Data format	-	- (Read only)	U8 / 1 / X / -
0x2323	DIP switch position	-	- (Read only)	U16 / 1 / - / -
0x232A	Modbus statistics			
	001: Messages received	-	- (Read only)	U32 / 1 / X / -
	002: Valid messages received	-	- (Read only)	U32 / 1 / X / -
	003: Messages with exceptions	-	- (Read only)	U32 / 1 / X / -
	004: Messages with errors	-	- (Read only)	U32 / 1 / X / -
	005: Messages sent	-	- (Read only)	U32 / 1 / X / -
0x232B	Modbus parameter mapping			
	001: Parameter 1	0x00000000	0x00000000 ... 0xFFFFFFFF00	L_INDEX / 1 / PH / -
	002: Parameter 2	0x00000000	0x00000000 ... 0xFFFFFFFF00	L_INDEX / 1 / PH / -
	003: Parameter 3	0x00000000	0x00000000 ... 0xFFFFFFFF00	L_INDEX / 1 / PH / -
	004: Parameter 4	0x00000000	0x00000000 ... 0xFFFFFFFF00	L_INDEX / 1 / PH / -
	005: Parameter 5	0x00000000	0x00000000 ... 0xFFFFFFFF00	L_INDEX / 1 / PH / -
	006: Parameter 6	0x00000000	0x00000000 ... 0xFFFFFFFF00	L_INDEX / 1 / PH / -
	007: Parameter 7	0x00000000	0x00000000 ... 0xFFFFFFFF00	L_INDEX / 1 / PH / -
	008: Parameter 8	0x00000000	0x00000000 ... 0xFFFFFFFF00	L_INDEX / 1 / PH / -
	009: Parameter 9	0x00000000	0x00000000 ... 0xFFFFFFFF00	L_INDEX / 1 / PH / -
	010: Parameter 10	0x00000000	0x00000000 ... 0xFFFFFFFF00	L_INDEX / 1 / PH / -
	011: Parameter 11	0x00000000	0x00000000 ... 0xFFFFFFFF00	L_INDEX / 1 / PH / -
	012: Parameter 12	0x00000000	0x00000000 ... 0xFFFFFFFF00	L_INDEX / 1 / PH / -
	013: Parameter 13	0x00000000	0x00000000 ... 0xFFFFFFFF00	L_INDEX / 1 / PH / -
	014: Parameter 14	0x00000000	0x00000000 ... 0xFFFFFFFF00	L_INDEX / 1 / PH / -
	015: Parameter 15	0x00000000	0x00000000 ... 0xFFFFFFFF00	L_INDEX / 1 / PH / -
	016: Parameter 16	0x00000000	0x00000000 ... 0xFFFFFFFF00	L_INDEX / 1 / PH / -
	017: Parameter 17	0x00000000	0x00000000 ... 0xFFFFFFFF00	L_INDEX / 1 / PH / -
	018: Parameter 18	0x00000000	0x00000000 ... 0xFFFFFFFF00	L_INDEX / 1 / PH / -
	019: Parameter 19	0x00000000	0x00000000 ... 0xFFFFFFFF00	L_INDEX / 1 / PH / -
	020: Parameter 20	0x00000000	0x00000000 ... 0xFFFFFFFF00	L_INDEX / 1 / PH / -
	021: Parameter 21	0x00000000	0x00000000 ... 0xFFFFFFFF00	L_INDEX / 1 / PH / -
	022: Parameter 22	0x00000000	0x00000000 ... 0xFFFFFFFF00	L_INDEX / 1 / PH / -
	023: Parameter 23	0x00000000	0x00000000 ... 0xFFFFFFFF00	L_INDEX / 1 / PH / -
	024: Parameter 24	0x00000000	0x00000000 ... 0xFFFFFFFF00	L_INDEX / 1 / PH / -
0x232C	Modbus register assignment			
	001: Register 1	-	- (Read only)	U16 / 1 / - / -
	002: Register 2	-	- (Read only)	U16 / 1 / - / -

* Default setting depending on the size.

Firmware-Version 01.01.01.00



Appendix

Parameter attribute list

Address	Name / Subindex: Name	Default setting	Setting range	D / F / A / M
	003: Register 3	-	- (Read only)	U16 / 1 / - / -
	004: Register 4	-	- (Read only)	U16 / 1 / - / -
	005: Register 5	-	- (Read only)	U16 / 1 / - / -
	006: Register 6	-	- (Read only)	U16 / 1 / - / -
	007: Register 7	-	- (Read only)	U16 / 1 / - / -
	008: Register 8	-	- (Read only)	U16 / 1 / - / -
	009: Register 9	-	- (Read only)	U16 / 1 / - / -
	010: Register 10	-	- (Read only)	U16 / 1 / - / -
	011: Register 11	-	- (Read only)	U16 / 1 / - / -
	012: Register 12	-	- (Read only)	U16 / 1 / - / -
	013: Register 13	-	- (Read only)	U16 / 1 / - / -
	014: Register 14	-	- (Read only)	U16 / 1 / - / -
	015: Register 15	-	- (Read only)	U16 / 1 / - / -
	016: Register 16	-	- (Read only)	U16 / 1 / - / -
	017: Register 17	-	- (Read only)	U16 / 1 / - / -
	018: Register 18	-	- (Read only)	U16 / 1 / - / -
	019: Register 19	-	- (Read only)	U16 / 1 / - / -
	020: Register 20	-	- (Read only)	U16 / 1 / - / -
	021: Register 21	-	- (Read only)	U16 / 1 / - / -
	022: Register 22	-	- (Read only)	U16 / 1 / - / -
	023: Register 23	-	- (Read only)	U16 / 1 / - / -
	024: Register 24	-	- (Read only)	U16 / 1 / - / -
0x232D	Modbus verification code	-	- (Read only)	U16 / 1 / - / -
0x232E	Modbus diagnostics of last RX data			
	001: Offset	0	0 ... 240	U8 / 1 / - / -
	002: Data byte 0	-	- (Read only)	U8 / 1 / - / -
	003: Data byte 1	-	- (Read only)	U8 / 1 / - / -
	004: Data byte 2	-	- (Read only)	U8 / 1 / - / -
	005: Data byte 3	-	- (Read only)	U8 / 1 / - / -
	006: Data byte 4	-	- (Read only)	U8 / 1 / - / -
	007: Data byte 5	-	- (Read only)	U8 / 1 / - / -
	008: Data byte 6	-	- (Read only)	U8 / 1 / - / -
	009: Data byte 7	-	- (Read only)	U8 / 1 / - / -
	010: Data byte 8	-	- (Read only)	U8 / 1 / - / -
	011: Data byte 9	-	- (Read only)	U8 / 1 / - / -
	012: Data byte 10	-	- (Read only)	U8 / 1 / - / -
	013: Data byte 11	-	- (Read only)	U8 / 1 / - / -
	014: Data byte 12	-	- (Read only)	U8 / 1 / - / -
	015: Data byte 13	-	- (Read only)	U8 / 1 / - / -
	016: Data byte 14	-	- (Read only)	U8 / 1 / - / -
	017: Data byte 15	-	- (Read only)	U8 / 1 / - / -
0x232F	Modbus diagnostics of last TX data			
	001: Offset	0	0 ... 240	U8 / 1 / - / -
	002: Data byte 0	-	- (Read only)	U8 / 1 / - / -
	003: Data byte 1	-	- (Read only)	U8 / 1 / - / -
	004: Data byte 2	-	- (Read only)	U8 / 1 / - / -
	005: Data byte 3	-	- (Read only)	U8 / 1 / - / -
	006: Data byte 4	-	- (Read only)	U8 / 1 / - / -
	007: Data byte 5	-	- (Read only)	U8 / 1 / - / -
	008: Data byte 6	-	- (Read only)	U8 / 1 / - / -
	009: Data byte 7	-	- (Read only)	U8 / 1 / - / -
	010: Data byte 8	-	- (Read only)	U8 / 1 / - / -
	011: Data byte 9	-	- (Read only)	U8 / 1 / - / -
	012: Data byte 10	-	- (Read only)	U8 / 1 / - / -

* Default setting depending on the size.

Firmware-Version 01.01.01.00

Appendix

Parameter attribute list



Address	Name / Subindex: Name	Default setting	Setting range	D / F / A / M
	013: Data byte 11	-	- (Read only)	U8 / 1 / - / -
	014: Data byte 12	-	- (Read only)	U8 / 1 / - / -
	015: Data byte 13	-	- (Read only)	U8 / 1 / - / -
	016: Data byte 14	-	- (Read only)	U8 / 1 / - / -
	017: Data byte 15	-	- (Read only)	U8 / 1 / - / -
0x2540	Mains voltage			
	001: Rated mains voltage	230 Veff [0]	Selection list	U8 / 1 / PC / -
	002: Undervoltage warning threshold	0 V *	0 ... 800 V	U16 / 1 / P / -
	003: Undervoltage error threshold	x V	- (Read only)	U16 / 1 / - / -
	004: Undervoltage reset threshold	x V	- (Read only)	U16 / 1 / - / -
	005: Overvoltage warning threshold	0 V *	0 ... 800 V	U16 / 1 / P / -
	006: Overvoltage error threshold	x V	- (Read only)	U16 / 1 / - / -
	007: Overvoltage reset threshold	x V	- (Read only)	U16 / 1 / - / -
0x2541	Brake energy management			
	001: Operating mode	Deceleration ramp function generator stop [1]	Selection list	U8 / 1 / P / -
	002: Active threshold	x V	- (Read only)	U16 / 1 / P / -
	003: Reduced threshold	0 V	0 ... 100 V	U16 / 1 / P / -
	004: Additional frequency	0.0 Hz	0.0 ... 10.0 Hz	U16 / 10 / P / -
	005: Deceleration override time	2.0 s	0.0 ... 60.0 s	U16 / 10 / P / -
0x2601	Keypad setpoints			
	001: Frequency setpoint	20.0 Hz	0.0 ... 599.0 Hz	U16 / 10 / P / r
	002: Process controller setpoint	0.00 PUnit	-300.00 ... 300.00 PUnit	I16 / 100 / P / r
0x261C	Favorites settings			
	001: Parameter 1	0x2DDD0000	0x00000000 ... 0xFFFFFFFF00	L_INDEX / 1 / PH / -
	002: Parameter 2	0x60780000	0x00000000 ... 0xFFFFFFFF00	L_INDEX / 1 / PH / -
	003: Parameter 3	0x2D890000	0x00000000 ... 0xFFFFFFFF00	L_INDEX / 1 / PH / -
	004: Parameter 4	0x603F0000	0x00000000 ... 0xFFFFFFFF00	L_INDEX / 1 / PH / -
	005: Parameter 5	0x28240000	0x00000000 ... 0xFFFFFFFF00	L_INDEX / 1 / PH / -
	006: Parameter 6	0x28600100	0x00000000 ... 0xFFFFFFFF00	L_INDEX / 1 / PH / -
	007: Parameter 7	0x28380100	0x00000000 ... 0xFFFFFFFF00	L_INDEX / 1 / PH / -
	008: Parameter 8	0x28380300	0x00000000 ... 0xFFFFFFFF00	L_INDEX / 1 / PH / -
	009: Parameter 9	0x25400100	0x00000000 ... 0xFFFFFFFF00	L_INDEX / 1 / PH / -
	010: Parameter 10	0x29150000	0x00000000 ... 0xFFFFFFFF00	L_INDEX / 1 / PH / -
	011: Parameter 11	0x29160000	0x00000000 ... 0xFFFFFFFF00	L_INDEX / 1 / PH / -
	012: Parameter 12	0x29170000	0x00000000 ... 0xFFFFFFFF00	L_INDEX / 1 / PH / -
	013: Parameter 13	0x29180000	0x00000000 ... 0xFFFFFFFF00	L_INDEX / 1 / PH / -
	014: Parameter 14	0x2C000000	0x00000000 ... 0xFFFFFFFF00	L_INDEX / 1 / PH / -
	015: Parameter 15	0x2B000000	0x00000000 ... 0xFFFFFFFF00	L_INDEX / 1 / PH / -
	016: Parameter 16	0x2B010100	0x00000000 ... 0xFFFFFFFF00	L_INDEX / 1 / PH / -
	017: Parameter 17	0x2B010200	0x00000000 ... 0xFFFFFFFF00	L_INDEX / 1 / PH / -
	018: Parameter 18	0x283A0000	0x00000000 ... 0xFFFFFFFF00	L_INDEX / 1 / PH / -
	019: Parameter 19	0x29390000	0x00000000 ... 0xFFFFFFFF00	L_INDEX / 1 / PH / -
	020: Parameter 20	0x2D4B0100	0x00000000 ... 0xFFFFFFFF00	L_INDEX / 1 / PH / -
	021: Parameter 21	0x2B120100	0x00000000 ... 0xFFFFFFFF00	L_INDEX / 1 / PH / -
	022: Parameter 22	0x60730000	0x00000000 ... 0xFFFFFFFF00	L_INDEX / 1 / PH / -
	023: Parameter 23	0x26310100	0x00000000 ... 0xFFFFFFFF00	L_INDEX / 1 / PH / -
	024: Parameter 24	0x26310200	0x00000000 ... 0xFFFFFFFF00	L_INDEX / 1 / PH / -
	025: Parameter 25	0x26310300	0x00000000 ... 0xFFFFFFFF00	L_INDEX / 1 / PH / -
	026: Parameter 26	0x26310400	0x00000000 ... 0xFFFFFFFF00	L_INDEX / 1 / PH / -
	027: Parameter 27	0x26310500	0x00000000 ... 0xFFFFFFFF00	L_INDEX / 1 / PH / -
	028: Parameter 28	0x26310600	0x00000000 ... 0xFFFFFFFF00	L_INDEX / 1 / PH / -
	029: Parameter 29	0x26310700	0x00000000 ... 0xFFFFFFFF00	L_INDEX / 1 / PH / -

* Default setting depending on the size.

Firmware-Version 01.01.01.00



Appendix

Parameter attribute list

Address	Name / Subindex: Name	Default setting	Setting range	D / F / A / M
	030: Parameter 30	0x26310800	0x00000000 ... 0xFFFFFFFF00	L_INDEX / 1 / PH / -
	031: Parameter 31	0x26310900	0x00000000 ... 0xFFFFFFFF00	L_INDEX / 1 / PH / -
	032: Parameter 32	0x26310D00	0x00000000 ... 0xFFFFFFFF00	L_INDEX / 1 / PH / -
	033: Parameter 33	0x26311200	0x00000000 ... 0xFFFFFFFF00	L_INDEX / 1 / PH / -
	034: Parameter 34	0x26311300	0x00000000 ... 0xFFFFFFFF00	L_INDEX / 1 / PH / -
	035: Parameter 35	0x26311400	0x00000000 ... 0xFFFFFFFF00	L_INDEX / 1 / PH / -
	036: Parameter 36	0x26340100	0x00000000 ... 0xFFFFFFFF00	L_INDEX / 1 / PH / -
	037: Parameter 37	0x26340200	0x00000000 ... 0xFFFFFFFF00	L_INDEX / 1 / PH / -
	038: Parameter 38	0x26360100	0x00000000 ... 0xFFFFFFFF00	L_INDEX / 1 / PH / -
	039: Parameter 39	0x26360200	0x00000000 ... 0xFFFFFFFF00	L_INDEX / 1 / PH / -
	040: Parameter 40	0x26360300	0x00000000 ... 0xFFFFFFFF00	L_INDEX / 1 / PH / -
	041: Parameter 41	0x26390100	0x00000000 ... 0xFFFFFFFF00	L_INDEX / 1 / PH / -
	042: Parameter 42	0x26390200	0x00000000 ... 0xFFFFFFFF00	L_INDEX / 1 / PH / -
	043: Parameter 43	0x26390300	0x00000000 ... 0xFFFFFFFF00	L_INDEX / 1 / PH / -
	044: Parameter 44	0x26390400	0x00000000 ... 0xFFFFFFFF00	L_INDEX / 1 / PH / -
	045: Parameter 45	0x29110100	0x00000000 ... 0xFFFFFFFF00	L_INDEX / 1 / PH / -
	046: Parameter 46	0x29110200	0x00000000 ... 0xFFFFFFFF00	L_INDEX / 1 / PH / -
	047: Parameter 47	0x29110300	0x00000000 ... 0xFFFFFFFF00	L_INDEX / 1 / PH / -
	048: Parameter 48	0x29110400	0x00000000 ... 0xFFFFFFFF00	L_INDEX / 1 / PH / -
	049: Parameter 49	0x00000000	0x00000000 ... 0xFFFFFFFF00	L_INDEX / 1 / PH / -
	050: Parameter 50	0x00000000	0x00000000 ... 0xFFFFFFFF00	L_INDEX / 1 / PH / -
0x2630	Settings for digital inputs			
	002: Input function	Digital input [0]	Selection list	U8 / 1 / P / -
0x2631	Function assignment			
	001: Controller enable	Constant TRUE [1]	Selection list	U8 / 1 / CP / -
	002: Start enable	Digital input 1 [11]	Selection list	U8 / 1 / CP / -
	003: Quick stop	Not connected [0]	Selection list	U8 / 1 / CP / -
	004: Reset error	Digital input 2 [12]	Selection list	U8 / 1 / P / -
	005: DC braking	Not connected [0]	Selection list	U8 / 1 / P / -
	006: Forward start (CW)	Not connected [0]	Selection list	U8 / 1 / CP / -
	007: Backward start (CCW)	Not connected [0]	Selection list	U8 / 1 / CP / -
	008: Forward run (CW)	Not connected [0]	Selection list	U8 / 1 / CP / -
	009: Backward run (CCW)	Not connected [0]	Selection list	U8 / 1 / CP / -
	010: Forward jog (CW)	Not connected [0]	Selection list	U8 / 1 / CP / -
	011: Backward jog (CCW)	Not connected [0]	Selection list	U8 / 1 / CP / -
	012: Keypad control	Not connected [0]	Selection list	U8 / 1 / P / -
	013: Reversal	Digital input 3 [13]	Selection list	U8 / 1 / CP / -
	014: Setpoint = AI1	Not connected [0]	Selection list	U8 / 1 / P / -
	015: Setpoint = AI2	Not connected [0]	Selection list	U8 / 1 / P / -
	016: Setpoint = Keypad	Not connected [0]	Selection list	U8 / 1 / P / -
	018: Preset val. selection bit 0	Digital input 4 [14]	Selection list	U8 / 1 / P / -
	019: Preset val. selection bit 1	Digital input 5 [15]	Selection list	U8 / 1 / P / -
	020: Preset val. selection bit 2	Not connected [0]	Selection list	U8 / 1 / P / -
	021: Preset val. selection bit 3	Not connected [0]	Selection list	U8 / 1 / P / -
	022: Setpoint = Digital frequency input	Not connected [0]	Selection list	U8 / 1 / P / -
	023: Motor potentiometer up	Not connected [0]	Selection list	U8 / 1 / P / -
	024: Motor potentiometer down	Not connected [0]	Selection list	U8 / 1 / P / -
	025: Setpoint = Motor potentiometer	Not connected [0]	Selection list	U8 / 1 / P / -
	037: Network enable	Not connected [0]	Selection list	U8 / 1 / P / -
	039: Activate ramp 2	Not connected [0]	Selection list	U8 / 1 / P / -
	040: Load parameter set	Not connected [0]	Selection list	U8 / 1 / CP / -
	041: Parameter set selection bit 0	Not connected [0]	Selection list	U8 / 1 / CP / -
	042: Parameter set selection bit 1	Not connected [0]	Selection list	U8 / 1 / CP / -
	043: User-defined fault 1	Not connected [0]	Selection list	U8 / 1 / P / -
* Default setting depending on the size.				Firmware-Version 01.01.01.00

Appendix

Parameter attribute list



Address	Name / Subindex: Name	Default setting	Setting range	D / F / A / M
	044: User-defined fault 2	Not connected [0]	Selection list	U8 / 1 / P / -
	045: Process controller off	Not connected [0]	Selection list	U8 / 1 / P / -
	046: Set process controller output to 0	Not connected [0]	Selection list	U8 / 1 / P / -
	047: Inhibit process controller I-component	Not connected [0]	Selection list	U8 / 1 / P / -
	048: Activate process controller influence ramp	Constant TRUE [1]	Selection list	U8 / 1 / P / -
	049: Release holding brake	Not connected [0]	Selection list	U8 / 1 / CP / -
0x2632	Inversion of digital inputs			
	001: Digital input 1	Not inverted [0]	Selection list	U8 / 1 / P / -
	002: Digital input 2	Not inverted [0]	Selection list	U8 / 1 / P / -
	003: Digital input 3	Not inverted [0]	Selection list	U8 / 1 / P / -
	004: Digital input 4	Not inverted [0]	Selection list	U8 / 1 / P / -
	005: Digital input 5	Not inverted [0]	Selection list	U8 / 1 / P / -
0x2633	Digital input debounce time			
	001: Digital input 1	1 ms	1 ... 50 ms	U8 / 1 / P / -
	002: Digital input 2	1 ms	1 ... 50 ms	U8 / 1 / P / -
	003: Digital input 3	1 ms	1 ... 50 ms	U8 / 1 / P / -
	004: Digital input 4	1 ms	1 ... 50 ms	U8 / 1 / P / -
	005: Digital input 5	1 ms	1 ... 50 ms	U8 / 1 / P / -
0x2634	Function assignment of digital outputs			
	001: Relay	Ready for operation [51]	Selection list	U8 / 1 / P / -
	002: Digital output 1	Release holding brake [115]	Selection list	U8 / 1 / P / -
	010: NETWordOUT1 - bit 0	Ready for operation [51]	Selection list	U8 / 1 / P / -
	011: NETWordOUT1 - bit 1	Reversal active [69]	Selection list	U8 / 1 / P / -
	012: NETWordOUT1 - bit 2	Running [50]	Selection list	U8 / 1 / P / -
	013: NETWordOUT1 - bit 3	Error active [56]	Selection list	U8 / 1 / P / -
	014: NETWordOUT1 - bit 4	Safe torque off (STO) active [55]	Selection list	U8 / 1 / P / -
	015: NETWordOUT1 - bit 5	Quick stop active [54]	Selection list	U8 / 1 / P / -
	016: NETWordOUT1 - bit 6	Actual speed = 0 [71]	Selection list	U8 / 1 / P / -
	017: NETWordOUT1 - bit 7	Device warning active [58]	Selection list	U8 / 1 / P / -
	018: NETWordOUT1 - bit 8	Release holding brake [115]	Selection list	U8 / 1 / P / -
	019: NETWordOUT1 - bit 9	Current limit reached [78]	Selection list	U8 / 1 / P / -
	020: NETWordOUT1 - bit 10	Setpoint speed reached [72]	Selection list	U8 / 1 / P / -
	021: NETWordOUT1 - bit 11	Not connected [0]	Selection list	U8 / 1 / P / -
	022: NETWordOUT1 - bit 12	Not connected [0]	Selection list	U8 / 1 / P / -
	023: NETWordOUT1 - bit 13	Not connected [0]	Selection list	U8 / 1 / P / -
	024: NETWordOUT1 - bit 14	Not connected [0]	Selection list	U8 / 1 / P / -
	025: NETWordOUT1 - bit 15	Not connected [0]	Selection list	U8 / 1 / P / -
0x2635	Inversion of digital outputs			
	001: Relay	Not inverted [0]	Selection list	U8 / 1 / P / -
	002: Digital output 1	Not inverted [0]	Selection list	U8 / 1 / P / -
0x2636	Analog input 1			
	001: Input range	0 ... 10 VDC [0]	Selection list	U8 / 1 / P / -
	002: Min value [Hz]	0.0 Hz	-1000.0 ... 1000.0 Hz	I16 / 10 / P / -
	003: Max value [Hz]	50.0 Hz	-1000.0 ... 1000.0 Hz	I16 / 10 / P / -
	004: Min value [Punit/%]	0.00 PUnit/%	-300.00 ... 300.00 PUnit/%	I16 / 100 / P / -
	005: Max value [Punit/%]	100.00 PUnit/%	-300.00 ... 300.00 PUnit/%	I16 / 100 / P / -
	006: Filter time	10 ms	0 ... 10000 ms	U16 / 1 / P / -
	007: Dead band	0.0 %	0.0 ... 100.0 %	U16 / 10 / P / -
	008: Monitoring threshold	0.0 %	-100.0 ... 100.0 %	I16 / 10 / P / -

* Default setting depending on the size.

Firmware-Version 01.01.01.00



Appendix

Parameter attribute list

Address	Name / Subindex: Name	Default setting	Setting range	D / F / A / M
	009: Monitoring condition	Input value < trigger threshold [0]	Selection list	U8 / 1 / P / -
	010: Monitoring response	Error [3]	Selection list	U8 / 1 / P / -
0x2637	Analog input 2			
	001: Input range	0 ... 10 VDC [0]	Selection list	U8 / 1 / P / -
	002: Min value [Hz]	0.0 Hz	-1000.0 ... 1000.0 Hz	I16 / 10 / P / -
	003: Max value [Hz]	50.0 Hz	-1000.0 ... 1000.0 Hz	I16 / 10 / P / -
	004: Min value [Punit/%]	0.00 PUnit/%	-300.00 ... 300.00 PUnit/%	I16 / 100 / P / -
	005: Max value [Punit/%]	100.00 PUnit/%	-300.00 ... 300.00 PUnit/%	I16 / 100 / P / -
	006: Filter time	10 ms	0 ... 10000 ms	U16 / 1 / P / -
	007: Dead band	0.0 %	0.0 ... 100.0 %	U16 / 10 / P / -
	008: Monitoring threshold	0.0 %	-100.0 ... 100.0 %	I16 / 10 / P / -
	009: Monitoring condition	Input value < trigger threshold [0]	Selection list	U8 / 1 / P / -
	010: Monitoring response	Error [3]	Selection list	U8 / 1 / P / -
0x2639	Analog output 1			
	001: Output range	0 ... 10 VDC [1]	Selection list	U8 / 1 / P / -
	002: Function	Output frequency [1]	Selection list	U8 / 1 / P / -
	003: Min signal value	0	-2147483648 ... 2147483647	I32 / 1 / P / -
	004: Max signal value	1000	-2147483648 ... 2147483647	I32 / 1 / P / -
0x2820	Holding brake control			
	001: Operating mode	No braking function [2]	Selection list	U8 / 1 / P / r
	002: Engagement time	100 ms	0 ... 10000 ms	U16 / 1 / P / -
	003: Disengagement time	100 ms	0 ... 10000 ms	U16 / 1 / P / -
	007: Application threshold	0.2 Hz	0.0 ... 599.0 Hz	U16 / 10 / P / -
	008: Holding load	0.0 %	-500.0 ... 500.0 %	I16 / 10 / P / -
	015: Brake status	-	-(Read only)	U8 / 1 / - / -
0x2822	Axis commands			
	001: Enable inverter	Controller inhibited [0]	Selection list	U8 / 1 / X / -
	002: Activate quick stop	0	0 ... 1	U8 / 1 / X / -
	003: Reset error	0	0 ... 1	U8 / 1 / X / -
	004: Motor identification	0	0 ... 1	U8 / 1 / X / -
	005: Motor assessment	0	0 ... 1	U8 / 1 / X / -
0x2823	001: Last subindex	-	-(Read only)	U8 / 1 / - / -
	002: Status of last axis command	-	-(Read only)	U8 / 1 / - / -
0x2824	Control selection	Terminal mode (flexible I/O configuration) [0]	Selection list	U8 / 1 / P / -
0x2826	Time-out for error response	6.0 s	0.0 ... 100.0 s	U16 / 10 / P / -
0x2827	Currently loaded parameter settings	-	-(Read only)	U8 / 1 / X / -
0x2829	Automatic storage in the memory module	Inhibit [0]	Selection list	U8 / 1 / P / -
0x282A	Status words			
	001: Cause of controller inhibit	-	-(Read only)	U32 / 1 / O / -
	002: Cause of quick stop	-	-(Read only)	U16 / 1 / O / -
	003: Cause of stop	-	-(Read only)	U16 / 1 / O / -
	004: Extended status word	-	-(Read only)	U16 / 1 / O / t
	005: Device status	-	-(Read only)	U8 / 1 / O / t
0x282B	Inverter diagnostics			
	001: Active control source	-	-(Read only)	U8 / 1 / O / t
	002: Active setpoint source	-	-(Read only)	U8 / 1 / O / t
	003: Keypad LCD status	-	-(Read only)	U8 / 1 / O / -
	004: Active drive mode	-	-(Read only)	U8 / 1 / O / t
	005: Most recently used control register	-	-(Read only)	U32 / 1 / OH / -
	006: Most recently used setpoint register	-	-(Read only)	U32 / 1 / OH / -
0x2831	Lenze status word	-	-(Read only)	U16 / 1 / O / t

* Default setting depending on the size.

Firmware-Version 01.01.01.00

Appendix

Parameter attribute list



Address	Name / Subindex: Name	Default setting	Setting range	D / F / A / M
0x2832	Motor identification status	-	- (Read only)	U16 / 1 / O / -
0x2833	Lenze status word 2	-	- (Read only)	U16 / 1 / O / t
0x2838	Start/stop configuration			
	001: Start method	Normal [0]	Selection list	U8 / 1 / CP / -
	002: Start at switch-on	Off [0]	Selection list	U8 / 1 / P / -
	003: Stop method	Standard Ramp [1]	Selection list	U8 / 1 / P / -
0x2839	Fault configuration			
	002: Restart delay	3.0 s	0.0 ... 1000.0 s	U16 / 10 / P / -
	003: Number of restart attempts	5	0 ... 255	U8 / 1 / P / -
	004: Down-counting time of glitch counter	5.0 s	0.1 ... 3600.0 s	U16 / 10 / P / -
	005: Current counter content of glitch counter	-	- (Read only)	U8 / 1 / - / -
0x283A	Limitation of rotation	Forwards and backwards [1]	Selection list	U8 / 1 / P / -
0x2857	CANopen monitoring			
	001: RPDO1-Timeout	Error [3]	Selection list	U8 / 1 / P / -
	002: RPDO2-Timeout	Error [3]	Selection list	U8 / 1 / P / -
	003: RPDO3-Timeout	Error [3]	Selection list	U8 / 1 / P / -
	005: Heartbeat-Timeout Consumer 1	Error [3]	Selection list	U8 / 1 / P / -
	006: Heartbeat-Timeout Consumer 2	Error [3]	Selection list	U8 / 1 / P / -
	007: Heartbeat-Timeout Consumer 3	Error [3]	Selection list	U8 / 1 / P / -
	008: Heartbeat-Timeout Consumer 4	Error [3]	Selection list	U8 / 1 / P / -
	010: "Bus-off" state change	Trouble [2]	Selection list	U8 / 1 / P / -
	011: Warning	Warning [1]	Selection list	U8 / 1 / P / -
0x2858	Modbus monitoring			
	001: Response to time-out	Error [3]	Selection list	U8 / 1 / P / -
	002: Time-out	2.0 s	0.0 ... 300.0 s	U16 / 10 / P / -
0x2860	Standard setpoint sources			
	001: Frequency setpoint source	Analog input 1 [2]	Selection list	U8 / 1 / P / -
	002: Process controller setpoint source	Keypad [1]	Selection list	U8 / 1 / P / -
	003: Torque setpoint source	Analog input 1 [2]	Selection list	U8 / 1 / P / -
0x2862	Keypad setpoint increment	1	1 ... 100	U16 / 1 / P / -
0x2863	Keypad language selection	English [1]	Selection list	U8 / 1 / P / -
0x2864	Keypad status display	0x00000000	0x00000000 ... 0xFFFFF00	L_INDEX / 1 / PH / -
0x2900	Speed controller parameters			
	001: Gain	0.00193 Nm/rpm *	0.00000 ... 20000.00000 Nm/rpm	U32 / 100000 / P / -
	002: Reset time	80.0 ms *	1.0 ... 6000.0 ms	U16 / 10 / P / -
0x2904	Filter time	2.0 ms	0.0 ... 50.0 ms	U16 / 10 / P / -
0x2910	Moment of inertia values			
	001: Motor	3.70 kg cm ² *	0.00 ... 20000000.00 kg cm ²	U32 / 100 / P / -
	002: Load	3.70 kg cm ² *	0.00 ... 20000000.00 kg cm ²	U32 / 100 / P / -
	003: Coupling	With clearance [2]	Selection list	U8 / 1 / P / -
0x2911	Preset frequency values			
	001: Preset value 1	20.0 Hz	0.0 ... 599.0 Hz	U16 / 10 / P / -
	002: Preset value 2	40.0 Hz	0.0 ... 599.0 Hz	U16 / 10 / P / -
	003: Preset value 3	50.0 Hz	0.0 ... 599.0 Hz	U16 / 10 / P / -
	004: Preset value 4	0.0 Hz	0.0 ... 599.0 Hz	U16 / 10 / P / -
	005: Preset value 5	0.0 Hz	0.0 ... 599.0 Hz	U16 / 10 / P / -
	006: Preset value 6	0.0 Hz	0.0 ... 599.0 Hz	U16 / 10 / P / -
	007: Preset value 7	0.0 Hz	0.0 ... 599.0 Hz	U16 / 10 / P / -
	008: Preset value 8	0.0 Hz	0.0 ... 599.0 Hz	U16 / 10 / P / -
	009: Preset value 9	0.0 Hz	0.0 ... 599.0 Hz	U16 / 10 / P / -
	010: Preset value 10	0.0 Hz	0.0 ... 599.0 Hz	U16 / 10 / P / -
	011: Preset value 11	0.0 Hz	0.0 ... 599.0 Hz	U16 / 10 / P / -

* Default setting depending on the size.

Firmware-Version 01.01.01.00



Appendix

Parameter attribute list

Address	Name / Subindex: Name	Default setting	Setting range	D / F / A / M
	012: Preset value 12	0.0 Hz	0.0 ... 599.0 Hz	U16 / 10 / P / -
	013: Preset value 13	0.0 Hz	0.0 ... 599.0 Hz	U16 / 10 / P / -
	014: Preset value 14	0.0 Hz	0.0 ... 599.0 Hz	U16 / 10 / P / -
	015: Preset value 15	0.0 Hz	0.0 ... 599.0 Hz	U16 / 10 / P / -
0x2912	Preset torque values			
	001: Preset value 1	100.0 %	-400.0 ... 400.0 %	I16 / 10 / P / -
	002: Preset value 2	100.0 %	-400.0 ... 400.0 %	I16 / 10 / P / -
	003: Preset value 3	100.0 %	-400.0 ... 400.0 %	I16 / 10 / P / -
	004: Preset value 4	100.0 %	-400.0 ... 400.0 %	I16 / 10 / P / -
	005: Preset value 5	100.0 %	-400.0 ... 400.0 %	I16 / 10 / P / -
	006: Preset value 6	100.0 %	-400.0 ... 400.0 %	I16 / 10 / P / -
	007: Preset value 7	100.0 %	-400.0 ... 400.0 %	I16 / 10 / P / -
	008: Preset value 8	100.0 %	-400.0 ... 400.0 %	I16 / 10 / P / -
0x2915	Minimum frequency	0.0 Hz	0.0 ... 599.0 Hz	U16 / 10 / P / -
0x2916	Maximum frequency	50.0 Hz	0.0 ... 599.0 Hz	U16 / 10 / P / -
0x2917	Acceleration time 1	5.0 s	0.0 ... 3600.0 s	U16 / 10 / P / r
0x2918	Deceleration time 1	5.0 s	0.0 ... 3600.0 s	U16 / 10 / P / r
0x2919	Acceleration time 2	5.0 s	0.0 ... 3600.0 s	U16 / 10 / P / -
0x291A	Deceleration time 2	5.0 s	0.0 ... 3600.0 s	U16 / 10 / P / -
0x291B	Auto-changeover threshold of ramp 2	0.0 Hz	0.0 ... 599.0 Hz	U16 / 10 / P / -
0x291C	Quick stop deceleration time	1.0 s	0.0 ... 3600.0 s	U16 / 10 / P / -
0x291E	S-Ramp characteristic			
	001: Smoothing factor	0.0 %	0.0 ... 100.0 %	U16 / 10 / P / -
0x291F	Skip frequencies			
	001: Frequency 1	0.0 Hz	0.0 ... 599.0 Hz	U16 / 10 / P / -
	002: Bandwidth 1	0.0 Hz	0.0 ... 10.0 Hz	U8 / 10 / P / -
	003: Frequency 2	0.0 Hz	0.0 ... 599.0 Hz	U16 / 10 / P / -
	004: Bandwidth 2	0.0 Hz	0.0 ... 10.0 Hz	U8 / 10 / P / -
	005: Frequency 3	0.0 Hz	0.0 ... 599.0 Hz	U16 / 10 / P / -
	006: Bandwidth 3	0.0 Hz	0.0 ... 10.0 Hz	U8 / 10 / P / -
	016: Status	-	- (Read only)	U16 / 1 / X / -
	032: Input frequency	x.xx Hz	- (Read only)	I32 / 100 / X / -
	033: Output frequency	x.xx Hz	- (Read only)	I32 / 100 / X / -
0x2939	Switching frequency	8 kHz variable / drive-optimised / 4 kHz min. [21]	Selection list	U8 / 1 / PC / -
0x2942	Current controller parameters			
	001: Gain	42.55 V/A *	0.00 ... 750.00 V/A	U32 / 100 / P / -
	002: Reset time	4.50 ms *	0.01 ... 2000.00 ms	U32 / 100 / P / -
0x2947	Inverter characteristic			
	001: y1 = U1 (x = 0.00 %)	0.00 V *	0.00 ... 20.00 V	U16 / 100 / P / -
	002: y2 = U2 (x = 6.25 %)	0.00 V *	0.00 ... 20.00 V	U16 / 100 / P / -
	003: y3 = U3 (x = 12.50 %)	0.00 V *	0.00 ... 20.00 V	U16 / 100 / P / -
	004: y4 = U4 (x = 18.75 %)	0.00 V *	0.00 ... 20.00 V	U16 / 100 / P / -
	005: y5 = U5 (x = 25.00 %)	0.00 V *	0.00 ... 20.00 V	U16 / 100 / P / -
	006: y6 = U6 (x = 31.25 %)	0.00 V *	0.00 ... 20.00 V	U16 / 100 / P / -
	007: y7 = U7 (x = 37.50 %)	0.00 V *	0.00 ... 20.00 V	U16 / 100 / P / -
	008: y8 = U8 (x = 42.75 %)	0.00 V *	0.00 ... 20.00 V	U16 / 100 / P / -
	009: y9 = U9 (x = 50.00 %)	0.00 V *	0.00 ... 20.00 V	U16 / 100 / P / -
	010: y10 = U10 (x = 56.25 %)	0.00 V *	0.00 ... 20.00 V	U16 / 100 / P / -
	011: y11 = U11 (x = 62.50 %)	0.00 V *	0.00 ... 20.00 V	U16 / 100 / P / -
	012: y12 = U12 (x = 68.75 %)	0.00 V *	0.00 ... 20.00 V	U16 / 100 / P / -
	013: y13 = U13 (x = 75.00 %)	0.00 V *	0.00 ... 20.00 V	U16 / 100 / P / -
	014: y14 = U14 (x = 81.25 %)	0.00 V *	0.00 ... 20.00 V	U16 / 100 / P / -

* Default setting depending on the size.

Firmware-Version 01.01.01.00

Appendix

Parameter attribute list



Address	Name / Subindex: Name	Default setting	Setting range	D / F / A / M
	015: $y_{15} = U_{15}$ ($x = 87.50\%$)	0.00 V *	0.00 ... 20.00 V	U16 / 100 / P / -
	016: $y_{16} = U_{16}$ ($x = 93.25\%$)	0.00 V *	0.00 ... 20.00 V	U16 / 100 / P / -
	017: $y_{17} = U_{17}$ ($x = 100.00\%$)	0.00 V *	0.00 ... 20.00 V	U16 / 100 / P / -
0x29C0	Field controller settings			
	001: Gain	59.68 A/Vs *	0.00 ... 50000.00 A/Vs	U32 / 100 / P / -
	002: Reset time	45.5 ms *	1.0 ... 6000.0 ms	U16 / 10 / P / -
0x29E0	Field weakening controller settings			
	001: Gain	0.000 Vs/V *	0.000 ... 2000000.000 Vs/V	U32 / 1000 / P / -
	002: Reset time	1478.3 ms *	1.0 ... 240000.0 ms	U32 / 10 / P / -
0x2B00	V/f characteristic shape	Linear [0]	Selection list	U8 / 1 / CP / -
0x2B01	V/f characteristic data			
	001: Base voltage	230 V *	0 ... 5000 V	U16 / 1 / P / -
	002: Base frequency	50 Hz *	0 ... 599 Hz	U16 / 1 / P / -
0x2B08	V/f Imax controller			
	001: Gain	0.284 Hz/A *	0.000 ... 1000.000 Hz/A	U32 / 1000 / P / -
	002: Reset time	2.3 ms *	1.0 ... 2000.0 ms	U32 / 10 / P / -
0x2B09	Slip compensation			
	001: Gain	100.00 %	-200.00 ... 200.00 %	I16 / 100 / P / -
	002: Filter time	5 ms	1 ... 6000 ms	U16 / 1 / P / -
0x2B0A	Oscillation damping			
	001: Gain	20 %	-100 ... 100 %	I16 / 1 / P / -
	002: Filter time	5 ms	1 ... 600 ms	U16 / 1 / P / -
0x2B0C	Override point of field weakening	0.0 Hz	-599.0 ... 599.0 Hz	I16 / 10 / P / -
0x2B0E	Frequency setpoint	x.x Hz	- (Read only)	I16 / 10 / O / t
0x2B0F	V/f operation: actual frequency of motor shaft	x.x Hz	- (Read only)	I16 / 10 / O / t
0x2B12	V/f voltage boost			
	001: Fixed boost	2.5 % *	0.0 ... 20.0 %	U8 / 10 / P / -
	002: Boost at acceleration	0.0 %	0.0 ... 20.0 %	U8 / 10 / P / -
0x2B40	SLVC			
	001: Gain	0.2686 Hz/A *	0.0000 ... 1000.0000 Hz/A	U32 / 10000 / P / -
	002: Reset time	2.3 ms *	1.0 ... 2000.0 ms	U32 / 10 / P / -
0x2B84	DC braking			
	001: Current	0.0 %	0.0 ... 200.0 %	U16 / 10 / P / -
	002: Automatic hold time	0.0 s	0.0 ... 999.9 s	U16 / 10 / P / -
	003: Automatic operating threshold	0.0 Hz	0.0 ... 599.0 Hz	U16 / 10 / P / -
0x2BA1	Flying restart circuit			
	001: Current	30 %	0 ... 100 %	U16 / 1 / P / -
	002: Start frequency	20.0 Hz	-599.0 ... 599.0 Hz	I16 / 10 / P / -
	003: Restart time	5911 ms *	1 ... 60000 ms	U16 / 1 / P / -
	008: Flying restart frequency	x.x Hz	- (Read only)	I16 / 10 / O / t
0x2C00	Motor control type	V/f characteristic control (VFC open loop) [6]	Selection list	U8 / 1 / CP / -
0x2C01	Motor parameters			
	001: Number of pole pairs	-	- (Read only)	U8 / 1 / - / -
	002: Stator resistance	10.1565 Ohm *	0.0000 ... 125.0000 Ohm	U32 / 10000 / P / -
	003: Stator leakage inductance	23.566 mH *	0.000 ... 500.000 mH	U32 / 1000 / P / -
	004: Rated speed	1450 rpm	50 ... 50000 rpm	U16 / 1 / P / -
	005: Rated frequency	50.0 Hz	1.0 ... 1000.0 Hz	U16 / 10 / P / -
	006: Rated power	0.25 kW *	0.00 ... 655.35 kW	U16 / 100 / P / -
	007: Rated voltage	230 V *	0 ... 65535 V	U16 / 1 / P / -
	008: Cosine phi	0.80	0.00 ... 1.00	U16 / 100 / P / -
	010: Name		Text	STRING[25] / 1 / P / -

* Default setting depending on the size.

Firmware-Version 01.01.01.00



Appendix

Parameter attribute list

Address	Name / Subindex: Name	Default setting	Setting range	D / F / A / M
0x2C02	Motor parameter (ASM)			
	001: Rotor resistance	8.8944 Ohm *	0.0000 ... 200.0000 Ohm	U32 / 10000 / P / -
	002: Mutual inductance	381.9 mH *	0.0 ... 50000.0 mH	U32 / 10 / P / -
	003: Magnetising current	0.96 A *	0.00 ... 500.00 A	U16 / 100 / P / -
	004: Slip frequency	x.x Hz	- (Read only)	U16 / 10 / - / -
0x2D40	Device utilisation (i*t)			
	002: Warning threshold	95 %	0 ... 101 %	U16 / 1 / P / -
	004: Actual utilisation	x %	- (Read only)	U16 / 1 / O / t
	005: Error response	Error [3]	<i>Selection list</i>	U8 / 1 / P / -
0x2D44	Overspeed monitoring			
	001: Threshold	8000 rpm	50 ... 50000 rpm	U16 / 1 / P / -
	002: Response	Error [3]	<i>Selection list</i>	U8 / 1 / P / -
0x2D45	Motor phase failure detection			
	001: Response	No response [0]	<i>Selection list</i>	U8 / 1 / P / -
	002: Current threshold	5.0 %	1.0 ... 10.0 %	U8 / 10 / P / -
	003: Voltage threshold	10.0 V	0.0 ... 100.0 V	U16 / 10 / P / -
0x2D46	Monitoring of ultimate motor current			
	001: Threshold	6.8 A *	0.0 ... 500.0 A	U16 / 10 / P / -
	002: Response	Error [3]	<i>Selection list</i>	U8 / 1 / P / -
0x2D4B	Motor overload monitoring (i ² *t)			
	001: Maximum utilisation [60 s]	150 %	30 ... 200 %	U16 / 1 / P / -
	002: Speed compensation	On [0]	<i>Selection list</i>	U8 / 1 / P / -
	003: Error response	Error [3]	<i>Selection list</i>	U8 / 1 / P / -
	005: Thermal load	-	- (Read only)	U16 / 1 / - / -
0x2D4F	Motor utilisation (i ² *t)	x %	- (Read only)	U16 / 1 / O / t
0x2D81	Service life timer			
	001: Operating time	x s	- (Read only)	U32 / 1 / T / -
	002: Operating time	x s	- (Read only)	U32 / 1 / T / -
	003: Control unit operating time	x ns	- (Read only)	U64 / 1 / T / -
	004: Main Switching Cycles	-	- (Read only)	U32 / 1 / - / -
	005: Relay switching cycles	-	- (Read only)	U32 / 1 / - / -
	006: Short-circuit counter	-	- (Read only)	U16 / 1 / - / -
	007: Earth fault counter	-	- (Read only)	U16 / 1 / - / -
	008: Clamp active	-	- (Read only)	U16 / 1 / - / -
	009: Fan operating time	x s	- (Read only)	U32 / 1 / T / -
0x2D84	Heatsink temperature monitoring			
	001: Actual value	x.x °C	- (Read only)	I16 / 10 / O / -
	002: Warning threshold	80.0 °C *	50.0 ... 100.0 °C	I16 / 10 / P / -
0x2D87	DC-bus voltage	x V	- (Read only)	U16 / 1 / O / t
0x2D88	Actual motor current	x.x A	- (Read only)	I16 / 10 / O / t
0x2D89	Actual motor voltage	x VAC	- (Read only)	U16 / 1 / O / t
0x2DA2	Output power			
	001: Effective	x.xxx kW	- (Read only)	I32 / 1000 / O / t
	002: Apparent power	x.xxx kW	- (Read only)	I32 / 1000 / O / t
0x2DA3	Output energy			
	001: Motor	x.xx kWh	- (Read only)	I32 / 100 / O / t
	002: Generator	x.xx kWh	- (Read only)	I32 / 100 / O / t
0x2DA4	Diagnostics of analog input 1			
	001: Value in percent	x.x %	- (Read only)	I16 / 10 / O / t
	002: Frequency value	x.x Hz	- (Read only)	I16 / 10 / O / t
	003: Process controller value	x.xx PUnit	- (Read only)	I16 / 100 / O / t
	004: Torque value	x.xx %	- (Read only)	I16 / 100 / O / t
	016: Status	-	- (Read only)	U16 / 1 / O / -

* Default setting depending on the size.

Firmware-Version 01.01.01.00

Appendix

Parameter attribute list



Address	Name / Subindex: Name	Default setting	Setting range	D / F / A / M
0x2DA5	Diagnostics of analog input 2			
	001: Value in percent	x.x %	- (Read only)	I16 / 10 / O / t
	002: Frequency value	x.x Hz	- (Read only)	I16 / 10 / O / t
	003: Process controller value	x.xx PUnit	- (Read only)	I16 / 100 / O / t
	004: Torque value	x.xx %	- (Read only)	I16 / 100 / O / t
	016: Status	-	- (Read only)	U16 / 1 / O / -
0x2DAA	Diagnostics of analog output 1			
	001: Voltage	x.xx V	- (Read only)	U16 / 100 / O / t
	002: Current	x.xx mA	- (Read only)	U16 / 100 / O / t
0x2DAC	Keypad status	-	- (Read only)	U16 / 1 / O / t
0x2DAD	Internal hardware states	-	- (Read only)	U16 / 1 / O / -
0x2DDD	Actual frequency	x.x Hz	- (Read only)	I16 / 10 / O / t
0x2DDF	Axis information			
	001: Rated current	x.xx A	- (Read only)	U16 / 100 / O / t
	002: Maximum current	x.xx A	- (Read only)	U16 / 100 / O / t
0x2EFF	001: Bootloader activation key 1	0	0 ... 4294967295	U32 / 1 / C / -
	002: Bootloader activation key 2	0	0 ... 4294967295	U32 / 1 / C / -
	003: Bootloader activation key 3	0	0 ... 4294967295	U32 / 1 / C / -
0x4002	Speed display scaling	0.00	0.00 ... 650.00	U16 / 100 / P / -
0x4003	Motor potentiometer starting mode	Last value [0]	<i>Selection list</i>	U8 / 1 / P / -
0x4004	Motor potentiometer starting values			
	001: Frequency	0.0 Hz	0.0 ... 599.0 Hz	U16 / 10 / P / -
	002: Process controller value	0.00 PUnit	-300.00 ... 300.00 PUnit	I16 / 100 / P / -
	003: Torque	0.0 %	0.0 ... 1000.0 %	U16 / 10 / P / -
0x4005	Frequency threshold	0.0 Hz	0.0 ... 599.0 Hz	U16 / 10 / P / -
0x4006	Load loss detection			
	001: Threshold	0.0 %	0.0 ... 200.0 %	U16 / 10 / P / -
	002: Deceleration	0.0 s	0.0 ... 300.0 s	U16 / 10 / P / -
0x4008	Process input words			
	001: NETWordIN1	0x0000	0x0000 ... 0xFFFF	U16 / 1 / KH / r
	002: NETWordIN2	0x0000	0x0000 ... 0xFFFF	U16 / 1 / KH / r
	003: NETWordIN3	0.0 %	0.0 ... 100.0 %	U16 / 10 / K / r
	004: NETWordIN4	0.0 %	0.0 ... 100.0 %	U16 / 10 / K / r
0x4009	Motor potentiometer values saved			
	001: Frequency	x.x Hz	- (Read only)	U16 / 10 / CP / t
	002: Process controller value	x.xx PUnit	- (Read only)	U16 / 100 / CP / t
	003: Torque	x.x %	- (Read only)	U16 / 10 / CP / t
0x400A	Process output words			
	001: NetWordOUT1	-	- (Read only)	U16 / 1 / H / t
	002: NetWordOUT2	-	- (Read only)	U16 / 1 / - / t
0x400B	Predefined process input data			
	001: AC Drive control word	0x0000	0x0000 ... 0xFFFF	U16 / 1 / OKH / r
	002: LECOM control word (C135)	0x0000	0x0000 ... 0xFFFF	U16 / 1 / OKH / r
	003: Network setpoint frequency [0.1 Hz]	0.0 Hz	0.0 ... 599.0 Hz	U16 / 10 / OK / r
	004: Network setpoint speed [r/min]	0 rpm	0 ... 50000 rpm	U16 / 1 / OK / r
	005: Network setpoint frequency [0.01 Hz]	0.00 Hz	0.00 ... 599.00 Hz	U16 / 100 / OK / r
	006: Network speed setpoint	0.0 Hz	-599.0 ... 599.0 Hz	I16 / 10 / OK / r
	007: Network process controller setpoint	0.00 PUnit	-300.00 ... 300.00 PUnit	I16 / 100 / OK / r
	008: Network torque setpoint	0 Nm	-32768 ... 32767 Nm	I16 / 1 / OK / r

* Default setting depending on the size.

Firmware-Version 01.01.01.00



Appendix

Parameter attribute list

Address	Name / Subindex: Name	Default setting	Setting range	D / F / A / M
0x400C	Predefined process output data			
	001: AC Drive status word	-	- (Read only)	U16 / 1 / - / t
	002: LECOM status word (C150)	-	- (Read only)	U16 / 1 / - / t
	003: Actual frequency [0.1 Hz]	x.x Hz	- (Read only)	U16 / 10 / - / t
	004: Actual motor speed [r/min]	x rpm	- (Read only)	U16 / 1 / - / t
	005: Drive status	-	- (Read only)	U16 / 1 / - / t
0x400D	006: Actual frequency [0.01 Hz]	x.xx Hz	- (Read only)	U16 / 100 / - / t
	Scaled actual value	x Units	- (Read only)	I16 / 1 / O / t
0x400E	NETWordIN1 function assignment			
	001: Bit 0	Not active [0]	<i>Selection list</i>	U8 / 1 / CP / -
	002: Bit 1	Not active [0]	<i>Selection list</i>	U8 / 1 / CP / -
	003: Bit 2	Quick stop [3]	<i>Selection list</i>	U8 / 1 / CP / -
	004: Bit 3	Forward run (CW) [8]	<i>Selection list</i>	U8 / 1 / CP / -
	005: Bit 4	Reversal [13]	<i>Selection list</i>	U8 / 1 / CP / -
	006: Bit 5	DC braking [5]	<i>Selection list</i>	U8 / 1 / CP / -
	007: Bit 6	Not active [0]	<i>Selection list</i>	U8 / 1 / CP / -
	008: Bit 7	Reset error [4]	<i>Selection list</i>	U8 / 1 / CP / -
	009: Bit 8	Preset val. selection bit 0 [18]	<i>Selection list</i>	U8 / 1 / CP / -
	010: Bit 9	Preset val. selection bit 1 [19]	<i>Selection list</i>	U8 / 1 / CP / -
	011: Bit 10	Not active [0]	<i>Selection list</i>	U8 / 1 / CP / -
	012: Bit 11	Not active [0]	<i>Selection list</i>	U8 / 1 / CP / -
	013: Bit 12	Not active [0]	<i>Selection list</i>	U8 / 1 / CP / -
	014: Bit 13	Not active [0]	<i>Selection list</i>	U8 / 1 / CP / -
	015: Bit 14	Not active [0]	<i>Selection list</i>	U8 / 1 / CP / -
016: Bit 15	Not active [0]	<i>Selection list</i>	U8 / 1 / CP / -	
0x4016	Digital output 1			
	003: Cutout delay	0.020 s	0.000 ... 65.535 s	U16 / 1000 / P / -
	004: Switch-on delay	0.020 s	0.000 ... 65.535 s	U16 / 1000 / P / -
	005: Terminal state	-	- (Read only)	U8 / 1 / X / -
0x4018	006: Trigger signal state	-	- (Read only)	U8 / 1 / X / -
	Relay			
	003: Cutout delay	0.020 s	0.000 ... 65.535 s	U16 / 1000 / P / -
	004: Switch-on delay	0.020 s	0.000 ... 65.535 s	U16 / 1000 / P / -
	005: Relay state	-	- (Read only)	U8 / 1 / X / -
0x401F	006: Trigger signal state	-	- (Read only)	U8 / 1 / X / -
	007: Switching cycles	-	- (Read only)	U32 / 1 / X / -
	Process controller diagnostics			
	001: Current setpoint	x.xx PUnit	- (Read only)	I16 / 100 / O / t
0x4020	002: Current feedback	x.xx PUnit	- (Read only)	I16 / 100 / O / t
	003: Status	-	- (Read only)	U8 / 1 / O / t
	Process controller			
0x4021	001: Operating mode	Inhibited [0]	<i>Selection list</i>	U8 / 1 / P / -
	002: Feedback source	Analog input 1 [1]	<i>Selection list</i>	U8 / 1 / P / -
	003: Closed-loop controlled speed range	100 %	0 ... 100 %	U16 / 1 / P / -
	004: Speed feedforward control source	Without speed feedforward control [0]	<i>Selection list</i>	U8 / 1 / P / -
0x4021	Process controller speed operation			
	001: Acceleration time	1.0 s	0.0 ... 3600.0 s	U16 / 10 / P / -
	002: Deceleration time	1.0 s	0.0 ... 3600.0 s	U16 / 10 / P / -

* Default setting depending on the size.

Firmware-Version 01.01.01.00

Appendix

Parameter attribute list



Address	Name / Subindex: Name	Default setting	Setting range	D / F / A / M
0x4022	Preset process controller values			
	001: Preset value 1	0.00 PUnit	-300.00 ... 300.00 PUnit	I16 / 100 / P / -
	002: Preset value 2	0.00 PUnit	-300.00 ... 300.00 PUnit	I16 / 100 / P / -
	003: Preset value 3	0.00 PUnit	-300.00 ... 300.00 PUnit	I16 / 100 / P / -
	004: Preset value 4	0.00 PUnit	-300.00 ... 300.00 PUnit	I16 / 100 / P / -
	005: Preset value 5	0.00 PUnit	-300.00 ... 300.00 PUnit	I16 / 100 / P / -
	006: Preset value 6	0.00 PUnit	-300.00 ... 300.00 PUnit	I16 / 100 / P / -
	007: Preset value 7	0.00 PUnit	-300.00 ... 300.00 PUnit	I16 / 100 / P / -
	008: Preset value 8	0.00 PUnit	-300.00 ... 300.00 PUnit	I16 / 100 / P / -
0x4023	Process controller idle state			
	001: Activation	Inhibited [0]	Selection list	U8 / 1 / P / -
	002: Stop method	Coasting [0]	Selection list	U8 / 1 / P / -
	003: Frequency threshold	0.0 Hz	0.0 ... 599.0 Hz	U16 / 10 / P / -
	004: Feedback threshold	0.00 PUnit	-300.00 ... 300.00 PUnit	I16 / 100 / P / -
	005: Deceleration time	0.0 s	0.0 ... 300.0 s	U16 / 10 / P / -
	006: Completion	Setpoint > threshold OR system deviation > bandwidth [0]	Selection list	U8 / 1 / P / -
	007: Bandwidth	0.00 PUnit	0.00 ... 300.00 PUnit	U16 / 100 / P / -
	008: Completion threshold	0.00 PUnit	-300.00 ... 300.00 PUnit	I16 / 100 / P / -
0x4024	Automatic rinsing			
	001: Rinsing in idle state	Inhibited [0]	Selection list	U8 / 1 / P / -
	002: Time period between rinsing processes	30.0 min	0.0 ... 6000.0 min	U16 / 10 / P / -
	003: Speed	0.0 Hz	-599.0 ... 599.0 Hz	I16 / 10 / P / -
	004: Duration of rinsing process	0.0 s	0.0 ... 6000.0 s	U16 / 10 / P / -
0x4041	Parameter change-over			
	001: Parameter 1	0x00000000	0x00000000 ... 0xFFFFFFFF00	L_INDEX / 1 / PH / -
	002: Parameter 2	0x00000000	0x00000000 ... 0xFFFFFFFF00	L_INDEX / 1 / PH / -
	003: Parameter 3	0x00000000	0x00000000 ... 0xFFFFFFFF00	L_INDEX / 1 / PH / -
	004: Parameter 4	0x00000000	0x00000000 ... 0xFFFFFFFF00	L_INDEX / 1 / PH / -
	005: Parameter 5	0x00000000	0x00000000 ... 0xFFFFFFFF00	L_INDEX / 1 / PH / -
	006: Parameter 6	0x00000000	0x00000000 ... 0xFFFFFFFF00	L_INDEX / 1 / PH / -
	007: Parameter 7	0x00000000	0x00000000 ... 0xFFFFFFFF00	L_INDEX / 1 / PH / -
	008: Parameter 8	0x00000000	0x00000000 ... 0xFFFFFFFF00	L_INDEX / 1 / PH / -
	009: Parameter 9	0x00000000	0x00000000 ... 0xFFFFFFFF00	L_INDEX / 1 / PH / -
	010: Parameter 10	0x00000000	0x00000000 ... 0xFFFFFFFF00	L_INDEX / 1 / PH / -
	011: Parameter 11	0x00000000	0x00000000 ... 0xFFFFFFFF00	L_INDEX / 1 / PH / -
	012: Parameter 12	0x00000000	0x00000000 ... 0xFFFFFFFF00	L_INDEX / 1 / PH / -
	013: Parameter 13	0x00000000	0x00000000 ... 0xFFFFFFFF00	L_INDEX / 1 / PH / -
	014: Parameter 14	0x00000000	0x00000000 ... 0xFFFFFFFF00	L_INDEX / 1 / PH / -
	015: Parameter 15	0x00000000	0x00000000 ... 0xFFFFFFFF00	L_INDEX / 1 / PH / -
	016: Parameter 16	0x00000000	0x00000000 ... 0xFFFFFFFF00	L_INDEX / 1 / PH / -
	017: Parameter 17	0x00000000	0x00000000 ... 0xFFFFFFFF00	L_INDEX / 1 / PH / -
	018: Parameter 18	0x00000000	0x00000000 ... 0xFFFFFFFF00	L_INDEX / 1 / PH / -
	019: Parameter 19	0x00000000	0x00000000 ... 0xFFFFFFFF00	L_INDEX / 1 / PH / -
	020: Parameter 20	0x00000000	0x00000000 ... 0xFFFFFFFF00	L_INDEX / 1 / PH / -
	021: Parameter 21	0x00000000	0x00000000 ... 0xFFFFFFFF00	L_INDEX / 1 / PH / -
	022: Parameter 22	0x00000000	0x00000000 ... 0xFFFFFFFF00	L_INDEX / 1 / PH / -
	023: Parameter 23	0x00000000	0x00000000 ... 0xFFFFFFFF00	L_INDEX / 1 / PH / -
	024: Parameter 24	0x00000000	0x00000000 ... 0xFFFFFFFF00	L_INDEX / 1 / PH / -
	025: Parameter 25	0x00000000	0x00000000 ... 0xFFFFFFFF00	L_INDEX / 1 / PH / -
	026: Parameter 26	0x00000000	0x00000000 ... 0xFFFFFFFF00	L_INDEX / 1 / PH / -
	027: Parameter 27	0x00000000	0x00000000 ... 0xFFFFFFFF00	L_INDEX / 1 / PH / -
	028: Parameter 28	0x00000000	0x00000000 ... 0xFFFFFFFF00	L_INDEX / 1 / PH / -

* Default setting depending on the size.

Firmware-Version 01.01.01.00



Appendix

Parameter attribute list

Address	Name / Subindex: Name	Default setting	Setting range	D / F / A / M
	029: Parameter 29	0x00000000	0x00000000 ... 0xFFFFFFFF00	L_INDEX / 1 / PH / -
	030: Parameter 30	0x00000000	0x00000000 ... 0xFFFFFFFF00	L_INDEX / 1 / PH / -
	031: Parameter 31	0x00000000	0x00000000 ... 0xFFFFFFFF00	L_INDEX / 1 / PH / -
	032: Parameter 32	0x00000000	0x00000000 ... 0xFFFFFFFF00	L_INDEX / 1 / PH / -
0x4042	Parameter value set 1			
	001: Value of parameter 1	0	-2147483648 ... 2147483647	I32 / 1 / P / -
	002: Value of parameter 2	0	-2147483648 ... 2147483647	I32 / 1 / P / -
	003: Value of parameter 3	0	-2147483648 ... 2147483647	I32 / 1 / P / -
	004: Value of parameter 4	0	-2147483648 ... 2147483647	I32 / 1 / P / -
	005: Value of parameter 5	0	-2147483648 ... 2147483647	I32 / 1 / P / -
	006: Value of parameter 6	0	-2147483648 ... 2147483647	I32 / 1 / P / -
	007: Value of parameter 7	0	-2147483648 ... 2147483647	I32 / 1 / P / -
	008: Value of parameter 8	0	-2147483648 ... 2147483647	I32 / 1 / P / -
	009: Value of parameter 9	0	-2147483648 ... 2147483647	I32 / 1 / P / -
	010: Value of parameter 10	0	-2147483648 ... 2147483647	I32 / 1 / P / -
	011: Value of parameter 11	0	-2147483648 ... 2147483647	I32 / 1 / P / -
	012: Value of parameter 12	0	-2147483648 ... 2147483647	I32 / 1 / P / -
	013: Value of parameter 13	0	-2147483648 ... 2147483647	I32 / 1 / P / -
	014: Value of parameter 14	0	-2147483648 ... 2147483647	I32 / 1 / P / -
	015: Value of parameter 15	0	-2147483648 ... 2147483647	I32 / 1 / P / -
	016: Value of parameter 16	0	-2147483648 ... 2147483647	I32 / 1 / P / -
	017: Value of parameter 17	0	-2147483648 ... 2147483647	I32 / 1 / P / -
	018: Value of parameter 18	0	-2147483648 ... 2147483647	I32 / 1 / P / -
	019: Value of parameter 19	0	-2147483648 ... 2147483647	I32 / 1 / P / -
	020: Value of parameter 20	0	-2147483648 ... 2147483647	I32 / 1 / P / -
	021: Value of parameter 21	0	-2147483648 ... 2147483647	I32 / 1 / P / -
	022: Value of parameter 22	0	-2147483648 ... 2147483647	I32 / 1 / P / -
	023: Value of parameter 23	0	-2147483648 ... 2147483647	I32 / 1 / P / -
	024: Value of parameter 24	0	-2147483648 ... 2147483647	I32 / 1 / P / -
	025: Value of parameter 25	0	-2147483648 ... 2147483647	I32 / 1 / P / -
	026: Value of parameter 26	0	-2147483648 ... 2147483647	I32 / 1 / P / -
	027: Value of parameter 27	0	-2147483648 ... 2147483647	I32 / 1 / P / -
	028: Value of parameter 28	0	-2147483648 ... 2147483647	I32 / 1 / P / -
	029: Value of parameter 29	0	-2147483648 ... 2147483647	I32 / 1 / P / -
	030: Value of parameter 30	0	-2147483648 ... 2147483647	I32 / 1 / P / -
	031: Value of parameter 31	0	-2147483648 ... 2147483647	I32 / 1 / P / -
	032: Value of parameter 32	0	-2147483648 ... 2147483647	I32 / 1 / P / -
0x4043	Parameter value set 2			
	001: Value of parameter 1	0	-2147483648 ... 2147483647	I32 / 1 / P / -
	002: Value of parameter 2	0	-2147483648 ... 2147483647	I32 / 1 / P / -
	003: Value of parameter 3	0	-2147483648 ... 2147483647	I32 / 1 / P / -
	004: Value of parameter 4	0	-2147483648 ... 2147483647	I32 / 1 / P / -
	005: Value of parameter 5	0	-2147483648 ... 2147483647	I32 / 1 / P / -
	006: Value of parameter 6	0	-2147483648 ... 2147483647	I32 / 1 / P / -
	007: Value of parameter 7	0	-2147483648 ... 2147483647	I32 / 1 / P / -
	008: Value of parameter 8	0	-2147483648 ... 2147483647	I32 / 1 / P / -
	009: Value of parameter 9	0	-2147483648 ... 2147483647	I32 / 1 / P / -
	010: Value of parameter 10	0	-2147483648 ... 2147483647	I32 / 1 / P / -
	011: Value of parameter 11	0	-2147483648 ... 2147483647	I32 / 1 / P / -
	012: Value of parameter 12	0	-2147483648 ... 2147483647	I32 / 1 / P / -
	013: Value of parameter 13	0	-2147483648 ... 2147483647	I32 / 1 / P / -
	014: Value of parameter 14	0	-2147483648 ... 2147483647	I32 / 1 / P / -
	015: Value of parameter 15	0	-2147483648 ... 2147483647	I32 / 1 / P / -
	016: Value of parameter 16	0	-2147483648 ... 2147483647	I32 / 1 / P / -

* Default setting depending on the size.

Firmware-Version 01.01.01.00

Appendix

Parameter attribute list



Address	Name / Subindex: Name	Default setting	Setting range	D / F / A / M
	017: Value of parameter 17	0	-2147483648 ... 2147483647	I32 / 1 / P / -
	018: Value of parameter 18	0	-2147483648 ... 2147483647	I32 / 1 / P / -
	019: Value of parameter 19	0	-2147483648 ... 2147483647	I32 / 1 / P / -
	020: Value of parameter 20	0	-2147483648 ... 2147483647	I32 / 1 / P / -
	021: Value of parameter 21	0	-2147483648 ... 2147483647	I32 / 1 / P / -
	022: Value of parameter 22	0	-2147483648 ... 2147483647	I32 / 1 / P / -
	023: Value of parameter 23	0	-2147483648 ... 2147483647	I32 / 1 / P / -
	024: Value of parameter 24	0	-2147483648 ... 2147483647	I32 / 1 / P / -
	025: Value of parameter 25	0	-2147483648 ... 2147483647	I32 / 1 / P / -
	026: Value of parameter 26	0	-2147483648 ... 2147483647	I32 / 1 / P / -
	027: Value of parameter 27	0	-2147483648 ... 2147483647	I32 / 1 / P / -
	028: Value of parameter 28	0	-2147483648 ... 2147483647	I32 / 1 / P / -
	029: Value of parameter 29	0	-2147483648 ... 2147483647	I32 / 1 / P / -
	030: Value of parameter 30	0	-2147483648 ... 2147483647	I32 / 1 / P / -
	031: Value of parameter 31	0	-2147483648 ... 2147483647	I32 / 1 / P / -
	032: Value of parameter 32	0	-2147483648 ... 2147483647	I32 / 1 / P / -
0x4044	Parameter value set 3			
	001: Value of parameter 1	0	-2147483648 ... 2147483647	I32 / 1 / P / -
	002: Value of parameter 2	0	-2147483648 ... 2147483647	I32 / 1 / P / -
	003: Value of parameter 3	0	-2147483648 ... 2147483647	I32 / 1 / P / -
	004: Value of parameter 4	0	-2147483648 ... 2147483647	I32 / 1 / P / -
	005: Value of parameter 5	0	-2147483648 ... 2147483647	I32 / 1 / P / -
	006: Value of parameter 6	0	-2147483648 ... 2147483647	I32 / 1 / P / -
	007: Value of parameter 7	0	-2147483648 ... 2147483647	I32 / 1 / P / -
	008: Value of parameter 8	0	-2147483648 ... 2147483647	I32 / 1 / P / -
	009: Value of parameter 9	0	-2147483648 ... 2147483647	I32 / 1 / P / -
	010: Value of parameter 10	0	-2147483648 ... 2147483647	I32 / 1 / P / -
	011: Value of parameter 11	0	-2147483648 ... 2147483647	I32 / 1 / P / -
	012: Value of parameter 12	0	-2147483648 ... 2147483647	I32 / 1 / P / -
	013: Value of parameter 13	0	-2147483648 ... 2147483647	I32 / 1 / P / -
	014: Value of parameter 14	0	-2147483648 ... 2147483647	I32 / 1 / P / -
	015: Value of parameter 15	0	-2147483648 ... 2147483647	I32 / 1 / P / -
	016: Value of parameter 16	0	-2147483648 ... 2147483647	I32 / 1 / P / -
	017: Value of parameter 17	0	-2147483648 ... 2147483647	I32 / 1 / P / -
	018: Value of parameter 18	0	-2147483648 ... 2147483647	I32 / 1 / P / -
	019: Value of parameter 19	0	-2147483648 ... 2147483647	I32 / 1 / P / -
	020: Value of parameter 20	0	-2147483648 ... 2147483647	I32 / 1 / P / -
	021: Value of parameter 21	0	-2147483648 ... 2147483647	I32 / 1 / P / -
	022: Value of parameter 22	0	-2147483648 ... 2147483647	I32 / 1 / P / -
	023: Value of parameter 23	0	-2147483648 ... 2147483647	I32 / 1 / P / -
	024: Value of parameter 24	0	-2147483648 ... 2147483647	I32 / 1 / P / -
	025: Value of parameter 25	0	-2147483648 ... 2147483647	I32 / 1 / P / -
	026: Value of parameter 26	0	-2147483648 ... 2147483647	I32 / 1 / P / -
	027: Value of parameter 27	0	-2147483648 ... 2147483647	I32 / 1 / P / -
	028: Value of parameter 28	0	-2147483648 ... 2147483647	I32 / 1 / P / -
	029: Value of parameter 29	0	-2147483648 ... 2147483647	I32 / 1 / P / -
	030: Value of parameter 30	0	-2147483648 ... 2147483647	I32 / 1 / P / -
	031: Value of parameter 31	0	-2147483648 ... 2147483647	I32 / 1 / P / -
	032: Value of parameter 32	0	-2147483648 ... 2147483647	I32 / 1 / P / -
0x4045	Parameter value set 4			
	001: Value of parameter 1	0	-2147483648 ... 2147483647	I32 / 1 / P / -
	002: Value of parameter 2	0	-2147483648 ... 2147483647	I32 / 1 / P / -
	003: Value of parameter 3	0	-2147483648 ... 2147483647	I32 / 1 / P / -
	004: Value of parameter 4	0	-2147483648 ... 2147483647	I32 / 1 / P / -

* Default setting depending on the size.

Firmware-Version 01.01.01.00



Appendix

Parameter attribute list

Address	Name / Subindex: Name	Default setting	Setting range	D / F / A / M
	005: Value of parameter 5	0	-2147483648 ... 2147483647	I32 / 1 / P / -
	006: Value of parameter 6	0	-2147483648 ... 2147483647	I32 / 1 / P / -
	007: Value of parameter 7	0	-2147483648 ... 2147483647	I32 / 1 / P / -
	008: Value of parameter 8	0	-2147483648 ... 2147483647	I32 / 1 / P / -
	009: Value of parameter 9	0	-2147483648 ... 2147483647	I32 / 1 / P / -
	010: Value of parameter 10	0	-2147483648 ... 2147483647	I32 / 1 / P / -
	011: Value of parameter 11	0	-2147483648 ... 2147483647	I32 / 1 / P / -
	012: Value of parameter 12	0	-2147483648 ... 2147483647	I32 / 1 / P / -
	013: Value of parameter 13	0	-2147483648 ... 2147483647	I32 / 1 / P / -
	014: Value of parameter 14	0	-2147483648 ... 2147483647	I32 / 1 / P / -
	015: Value of parameter 15	0	-2147483648 ... 2147483647	I32 / 1 / P / -
	016: Value of parameter 16	0	-2147483648 ... 2147483647	I32 / 1 / P / -
	017: Value of parameter 17	0	-2147483648 ... 2147483647	I32 / 1 / P / -
	018: Value of parameter 18	0	-2147483648 ... 2147483647	I32 / 1 / P / -
	019: Value of parameter 19	0	-2147483648 ... 2147483647	I32 / 1 / P / -
	020: Value of parameter 20	0	-2147483648 ... 2147483647	I32 / 1 / P / -
	021: Value of parameter 21	0	-2147483648 ... 2147483647	I32 / 1 / P / -
	022: Value of parameter 22	0	-2147483648 ... 2147483647	I32 / 1 / P / -
	023: Value of parameter 23	0	-2147483648 ... 2147483647	I32 / 1 / P / -
	024: Value of parameter 24	0	-2147483648 ... 2147483647	I32 / 1 / P / -
	025: Value of parameter 25	0	-2147483648 ... 2147483647	I32 / 1 / P / -
	026: Value of parameter 26	0	-2147483648 ... 2147483647	I32 / 1 / P / -
	027: Value of parameter 27	0	-2147483648 ... 2147483647	I32 / 1 / P / -
	028: Value of parameter 28	0	-2147483648 ... 2147483647	I32 / 1 / P / -
	029: Value of parameter 29	0	-2147483648 ... 2147483647	I32 / 1 / P / -
	030: Value of parameter 30	0	-2147483648 ... 2147483647	I32 / 1 / P / -
	031: Value of parameter 31	0	-2147483648 ... 2147483647	I32 / 1 / P / -
	032: Value of parameter 32	0	-2147483648 ... 2147483647	I32 / 1 / P / -
0x4046	Activation of parameter set	Via command (only if the controller is inhibited) [0]	Selection list	U8 / 1 / P / -
0x4047	Parameter change-over error message			
	001: Status	-	- (Read only)	U16 / 1 / X / -
	002: List entry	-	- (Read only)	U8 / 1 / X / -
0x4048	P component gain	5.0 %	0.0 ... 1000.0 %	U16 / 10 / P / -
0x4049	I component reset time	400 ms	20 ... 6000 ms	U16 / 1 / P / -
0x404A	D component gain	0.0 s	0.0 ... 20.0 s	U8 / 10 / P / -
0x404B	Setpoint ramp (process controller)	20.0 s	0.0 ... 100.0 s	U16 / 10 / P / -
0x404C	Process controller influence			
	001: Acceleration time for showing	5.0 s	0.0 ... 999.9 s	U16 / 10 / P / -
	002: Deceleration time for masking out	5.0 s	0.0 ... 999.9 s	U16 / 10 / P / -
0x404D	Process controller alarms			
	001: MIN alarm threshold	0.00 PUnit	-300.00 ... 300.00 PUnit	I16 / 100 / P / -
	002: MAX alarm threshold	100.00 PUnit	-300.00 ... 300.00 PUnit	I16 / 100 / P / -
0x404E	Setpoint limits (process controller)			
	001: Minimum setpoint	-300.00 PUnit	-300.00 ... 300.00 PUnit	I16 / 100 / P / -
	002: Maximum setpoint	300.00 PUnit	-300.00 ... 300.00 PUnit	I16 / 100 / P / -
0x603F	Error code	-	- (Read only)	U16 / 1 / O / t
0x6040	Controlword	0	0 ... 65535	U16 / 1 / O / r
0x6041	Statusword	-	- (Read only)	U16 / 1 / O / t
0x6042	Target velocity	0 rpm	-32768 ... 32767 rpm	I16 / 1 / OK / r
0x6043	Velocity demand	x rpm	- (Read only)	I16 / 1 / O / t
0x6044	Velocity actual value	x rpm	- (Read only)	I16 / 1 / O / t

* Default setting depending on the size.

Firmware-Version 01.01.01.00

Appendix

Parameter attribute list



Address	Name / Subindex: Name	Default setting	Setting range	D / F / A / M
0x6046	Velocity min max amount			
	001: Velocity min amount	0 rpm	0 ... 480000 rpm	U32 / 1 / P / r
	002: Velocity max amount	480000 rpm	0 ... 480000 rpm	U32 / 1 / P / r
0x6048	Velocity acceleration			
	001: Delta speed	3000 rpm	0 ... 2147483647 rpm	U32 / 1 / PO / r
	002: Delta time	10 s	0 ... 65535 s	U16 / 1 / PO / r
0x6049	Velocity deceleration			
	001: Delta speed	3000 rpm	0 ... 2147483647 rpm	U32 / 1 / PO / r
	002: Delta time	10 s	0 ... 65535 s	U16 / 1 / PO / r
0x605A	Quick stop option code	Quick stop ramp -> switch-on inhibited [2]	<i>Selection list</i>	I16 / 1 / P / -
0x605E	Fault reaction option code	Coasting [0]	<i>Selection list</i>	I16 / 1 / - / -
0x6060	Modes of operation	Lenze speed mode [-2]	<i>Selection list</i>	I8 / 1 / CPO / r
0x6061	Modes of operation display	-	- (Read only)	I8 / 1 / O / t
0x6071	Target torque	0.0 %	-3276.8 ... 3276.7 %	I16 / 10 / OK / r
0x6073	Max current	200.0 %	0.0 ... 3000.0 %	U16 / 10 / P / -
0x6074	Torque demand value	x.x %	- (Read only)	I16 / 10 / O / -
0x6075	Motor rated current	1.700 A *	0.001 ... 500.000 A	U32 / 1000 / CP / -
0x6076	Motor rated torque	1.650 Nm *	0.001 ... 1000.000 Nm	U32 / 1000 / CP / -
0x6077	Torque actual value	x.x %	- (Read only)	I16 / 10 / O / t
0x6078	Current actual value	x.x %	- (Read only)	I16 / 10 / O / t
0x6079	DC link circuit voltage	x.xxx V	- (Read only)	U32 / 1000 / O / t
0x6080	Max motor speed	6075 rpm	0 ... 480000 rpm	U32 / 1 / PO / r
0x6085	Quick stop deceleration	546000 pos. unit / s²	0 ... 2147483647 pos. unit / s ²	U32 / 1 / P / -
0x60FD	Digital inputs	-	- (Read only)	U32 / 1 / O / t
0x6502	Supported drive modes	-	- (Read only)	U32 / 1 / - / -
* Default setting depending on the size.				Firmware-Version 01.01.01.00

🏢 Lenze Drives GmbH
Postfach 10 13 52, D-31763 Hameln
Breslauer Straße 3, D-32699 Extertal
Germany
HR Lemgo B 6478
☎ +49 5154 82-0
📠 +49 5154 82-2800
@ lenze@lenze.com
🌐 www.lenze.com

✂ Lenze Service GmbH
Breslauer Straße 3, D-32699 Extertal
Germany
☎ 0080002446877 (24 h helpline)
📠 +49 5154 82-1112
@ service.de@lenze.com

TD 20151120