

Datasheet - AZ 17-02ZRI-ST-B5

Safety switch with separate actuator / AZ 17ZI / AZ 17/170ZI-B5



- Thermoplastic enclosure
- Double-insulated
- Long life
- 30 mm x 60 mm x 30 mm
- Small body
- Individual coding
- High level of contact reliability with low voltages and currents
- Not sensitive to dirty conditions by virtue of patented roller system
- 8 actuating planes
- Slot sealing plug included
- Particularly suitable for hinged guards (front mounting)
- Connector M12 x 1, 4-pole

(Minor differences between the printed image and the original product may exist!)

Ordering details

Product type description	AZ 17-02ZRI-ST-B5
Article number	101144084
EAN code	4030661130835
eCl@ss	27-27-26-02

Approval

Approval



Classification

Standards	EN ISO 13849-1
B _{10d} Normally-closed contact (NC)	2.000.000
Mission time notice	20 Years
	$MTTF_d = \frac{B_{10d}}{0,1 \times n_{op}}$ $n_{op} = \frac{d_{op} \times h_{op} \times 3600 \text{ s/h}}{t_{cycle}}$

Global Properties

Product name	AZ 17ZI
Standards	EN 60947-5-1, BG-GS-ET-15
Materials	
- Material of the housings	Plastic, glass-fibre reinforced thermoplastic, self-extinguishing
- Material of the actuator	Stainless steel
- Material of the contacts	Silver
Housing coating	None
Weight	90 g

Mechanical data

Design of electrical connection	Connector M12
Mechanical life	> 1.000.000 operations
higher Latching force (Y/N)	Yes
Latching force	30 N
Positive break force	17 N
positive break travel	11 mm
Max. Actuating speed	2 m/s

Ambient conditions

Ambient temperature	
- Min. environmental temperature	-30 °C
- Max. environmental temperature	+80 °C
Protection class	IP67 to IEC/EN 60529

Electrical data

Design of control element	Opener (NC)
Switching principle	Creep circuit element
Number of auxiliary contacts	0 piece
Number of safety contacts	2 piece
Supply voltage	
- Min. supply voltage	
- Max. supply voltage	230 V
Rated impulse withstand voltage U_{imp}	4 kV
Rated insulation voltage U_i	250 V
Thermal test current I_{the}	10 A
Utilisation category	AC-15: 230 V / 4 A DC-13: 24 V / 4 A
Max. fuse rating	6 A gG D-fuse

ATEX

Explosion protection categories for gases	None
Explosion protected category for dusts	None

Dimensions

Dimensions of the sensor	
- Width of sensor	30 mm
- Height of sensor	85 mm
- Length of sensor	30 mm

notice

On hinged guards, minimum actuating radius at 90° to the plane of the actuator 140 mm
minimum actuating radius on hinged guards in line with the plane of the actuator 200 mm
The axis of the hinge should be 13 mm above the top edge of the safety switch and in the same plane
The actuator is not available separately.

Included in delivery

Not available as spare part



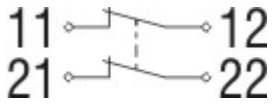

Included in delivery

- Individually coded actuator
- tamperproof screws
- Slot sealing plugs

Diagram







Note Diagram

-  positive break NC contact
-  active
-  no active
-  Normally-open contact
-  Normally-closed contact

Switch travel diagram



Notes Switch travel diagram

-  Contact closed
-  Contact open
-  Setting range
-  Break point
-  Positive opening sequence/- angle
- VS** adjustable range of NO contact
- VÖ** adjustable range of NC contact
- N** after travel

Ordering suffix

The applicable ordering suffix is added at the end of the part number of the safety switch.

Order example: AZ 17-02ZRI-ST-B5-**2243**

...-**2243**

Cable output: front

...-2243 -1	Cable output: rear
...-1637	0,3 µm gold-plated contacts
...-5M	Cable length 5 Meter
...-6M	Cable length 6 Meter

Ordering code

AZ 17-(1)Z(2)I-(3)-(4)-(5)

(1)	
11	1 Normally open contact (NO) / 1 Opener (NC)
02	2 Opener (NC)
(2)	
<i>without</i>	Latching force 5 N
R	Latching force 30 N
(3)	
<i>without</i>	cable gland M16
ST	Connector M12
(4)	
B1	Actuator B1
B5	Actuator B5
B6L	Actuator B6L
B6R	Actuator B6R
(5)	
1637	gold-plated contacts

Documents

Operating instructions and Declaration of conformity (de) 316 kB, 05.02.2014

Code: mrl_az17-azm170-betaetiger_de

Operating instructions and Declaration of conformity (pl) 157 kB, 11.03.2014

Code: mrl_az17-azm170-betaetiger_pl

Operating instructions and Declaration of conformity (it) 117 kB, 10.02.2014

Code: mrl_az17-azm170-betaetiger_it

Operating instructions and Declaration of conformity (pt) 116 kB, 23.05.2014

Code: mrl_az17-azm170-betaetiger_pt

Operating instructions and Declaration of conformity (en) 116 kB, 24.02.2014

Code: mrl_az17-azm170-betaetiger_en

Operating instructions and Declaration of conformity (jp) 171 kB, 03.04.2014

Code: mrl_az17-azm170-betaetiger_jp

Operating instructions and Declaration of conformity (sv) 115 kB, 17.06.2015

Code: mrl_az17-azm170-betaetiger_sv

Operating instructions and Declaration of conformity (nl) 116 kB, 11.03.2014

Code: mrl_az17-azm170-betaetiger_nl

Operating instructions and Declaration of conformity (fr) 117 kB, 03.04.2014

Code: mrl_az17-azm170-betaetiger_fr

Operating instructions and Declaration of conformity (es) 117 kB, 12.02.2014

Code: mrl_az17-azm170-betaetiger_es

BG-test certificate (en) 578 kB, 15.08.2011

Code: z_z17p02

BG-test certificate (de) 589 kB, 15.08.2011

Code: z_z17p01

CCC certification (cn) 408 kB, 24.06.2014

Code: q_175p03

CCC certification (en) 396 kB, 24.06.2014

Code: q_175p02

Images

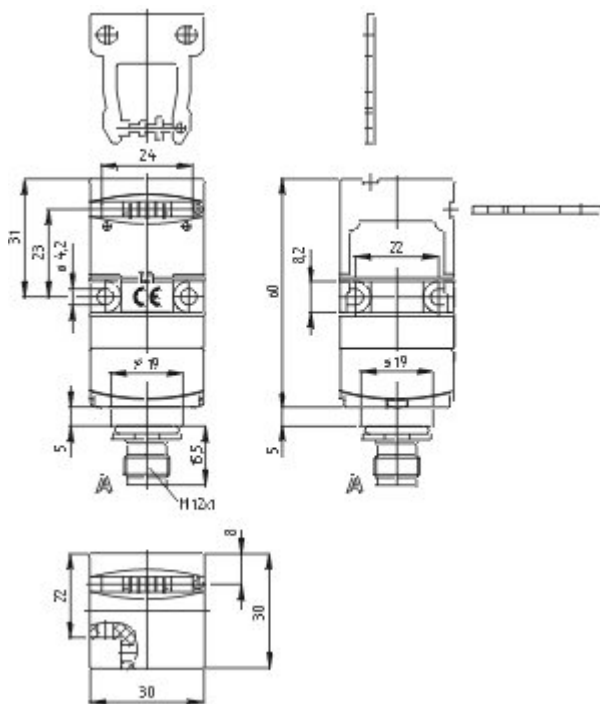

Dimensional drawing (basic component)

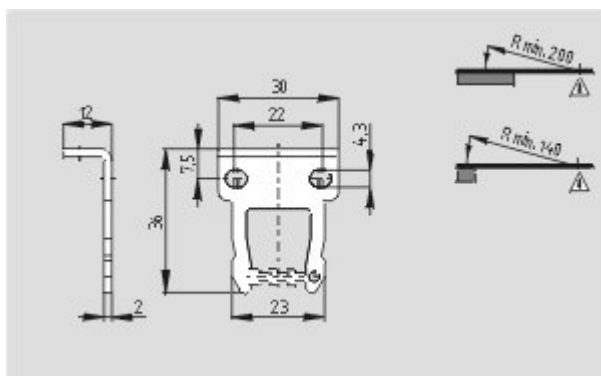

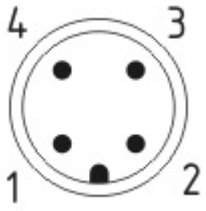

Contact arrangement

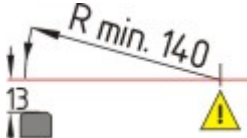

Actuating radius

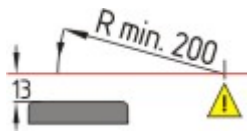

Actuating radius

System components

Connector



S-K4M12

- Connector without cable
- 4-pole



A-K4M12

- Pre-wired cable
 - 4-pole
-