

Datasheet - AZ 415-02/02ZPK

Safety switch with separate actuator / AZ 415



Preferred typ



- Metal enclosure
- Spring-loaded actuators
- Long life
- High level of contact reliability with low voltages and currents
- Adjustable ball latch to 400 N
- 2 cable entries M 20 x 1.5
- 2 switches with different actuating functions in one enclosure
- 84,6 mm x 103,6 mm x 46,5 mm

(Minor differences between the printed image and the original product may exist!)

Ordering details

Product type description	AZ 415-02/02ZPK
Article number	101164609
EAN code	4030661206509
eCl@ss	27-27-26-02

Approval

Approval

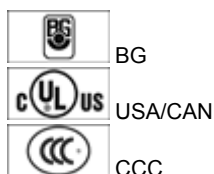

Classification

Standards	EN ISO 13849-1
B _{10d} Opener (NC)	2.000.000
Mission time notice	20 Years
	$MTTF_d = \frac{B_{10d}}{0,1 \times n_{op}}$ $n_{op} = \frac{d_{op} \times h_{op} \times 3600 \text{ s/h}}{t_{cycle}}$

Global Properties

Product name	AZ 415
Standards	EN 60947-5-1, BG-GS-ET-15
Compliance with the Directives (Y/N) 	Yes
Number of guard doors	1 piece
Materials	
- Material of the housings	Aluminium
- Material of the contacts	Silver
Housing coating	painted
Weight	595 g

Mechanical data

Design of electrical connection	Screw connection
Cable section	
- Min. Cable section	2 x 0,75 mm ²
- Max. Cable section	2 x 1.5 mm ²
Mechanical life	> 1.000.000 operations
notice	All indications about the cable section are including the conductor ferrules.
higher Latching force (Y/N)	Yes
Latching force	80 N ... 400 N
Positive break force	31 N min.
positive break travel	3.8 mm
Max. Actuating speed	0,2 m/s

Ambient conditions

Ambient temperature	
- Min. environmental temperature	-25 °C
- Max. environmental temperature	+70 °C
Protection class	IP67 to IEC/EN 60529

Electrical data

Design of control element	Opener (NC)
Switching principle	Creep circuit element
Number of auxiliary contacts	0 piece
Number of safety contacts	4 piece
Rated impulse withstand voltage U_{imp}	4 kV
Rated insulation voltage U_i	250 V
Thermal test current I_{the}	6 A
Utilisation category	AC-15: 230 V / 4 A; DC-13: 24 V / 4 A
Max. fuse rating	6 A gG D-fuse To DIN EN 60269-1

ATEX

Explosion protection categories for gases	None
Explosion protected category for dusts	None

Dimensions

Dimensions of the sensor

- Width of sensor	84.6 mm
- Height of sensor	103.6 mm
- Length of sensor	46.5 mm



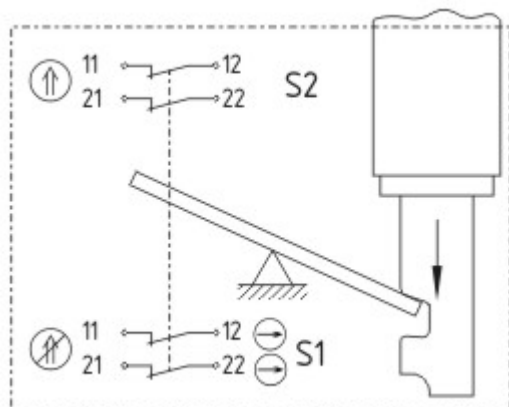

Included in delivery

Actuators must be ordered separately.

Diagram





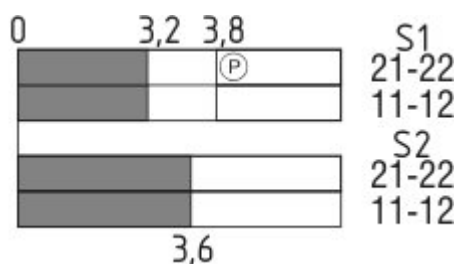

Note Diagram

-  positive break NC contact
-  active
-  no active
-  Normally-open contact
-  Normally-closed contact

Switch travel diagram



Notes Switch travel diagram

-  Contact closed
-  Contact open
-  Setting range
-  Break point
-  Positive opening sequence/- angle
- VS** adjustable range of NO contact
- VÖ** adjustable range of NC contact
- N** after travel

Ordering suffix

The applicable ordering suffix is added at the end of the part number of the safety switch.
Order example: AZ 415-02/02ZPK-1637

Ordering code

AZ 415-(1)ZPK-(2)

(1)

02/11	2 Opener (NC) / 1 Normally open contact (NO), 1 Opener (NC)
02/02	2 Opener (NC) / 2 Opener (NC)
02/20	2 Opener (NC) / 2 Normally open contact (NO)
11/11	1 Normally open contact (NO), 1 Opener (NC) / 1 Normally open contact (NO), 1 Opener (NC)

(2)

1637	gold-plated contacts
------	----------------------

Documents

Operating instructions and Declaration of conformity (es) 269 kB, 04.05.2011

Code: mrl_az415_es

Operating instructions and Declaration of conformity (nl) 291 kB, 18.08.2011

Code: mrl_az415_nl

Operating instructions and Declaration of conformity (en) 528 kB, 27.10.2010

Code: mrl_az415_en

Operating instructions and Declaration of conformity (de) 527 kB, 27.10.2010

Code: mrl_az415_de

Operating instructions and Declaration of conformity (pt) 283 kB, 24.04.2012

Code: mrl_az415_pt

Operating instructions and Declaration of conformity (it) 276 kB, 04.01.2012

Code: mrl_az415_it

Operating instructions and Declaration of conformity (da) 283 kB, 07.08.2012

Code: mrl_az415_da

Operating instructions and Declaration of conformity (pl) 292 kB, 04.03.2015

Code: mrl_az415_pl

Operating instructions and Declaration of conformity (jp) 766 kB, 18.11.2010

Code: mrl_az415_jp

Operating instructions and Declaration of conformity (fr) 271 kB, 04.05.2011

Code: mrl_az415_fr

BG-test certificate (de) 522 kB, 05.01.2011

Code: z_z41p01

CCC certification (cn) 408 kB, 24.06.2014

Code: q_175p03

CCC certification (en) 396 kB, 24.06.2014

Code: q_175p02

Gost certification (ru) 2 MB, 07.07.2011

Code: q_az1p01

Images

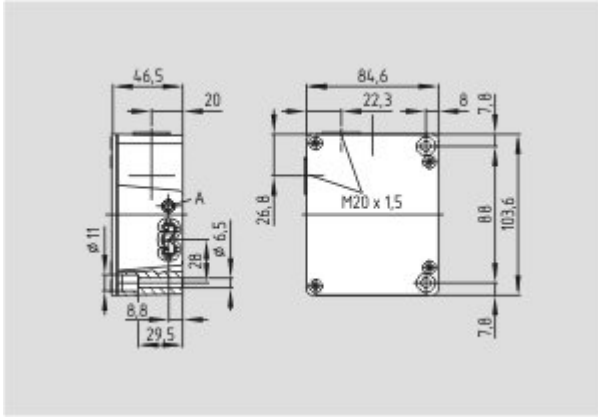

Dimensional drawing (basic component)

System components

Actuator



101128545 - AZ/AZM 415-B1

- For sliding doors
 - Actuators with return spring
 - Tolerates up to max. 6 mm overtravel
-



101144796 - AZ/AZM 415-B2

- Particularly suitable for hinged guards
 - For very small actuating radii in line with the plane of the actuator
-



101144797 - AZ/AZM 415-B3

- Particularly suitable for hinged guards
 - For very small actuating radii at 90° to the plane of the actuator
-



1142540 - AZ/AZM 415-B4PS

- For sliding doors
 - with locking bolt and ball latch
-

Door-handle system



AZ 415-ST30

- Latching handle
- Suitable for all types of guard

Accessories



101160461 - SZ AZ 415-22-1



101160462 - SZ AZ 415-22-2

Mounting accessories



1135338 - TAMPERPROOF SCREWS M 5 x 12

- To mount the actuator
- Higher protection against tampering with interlock
- Protects against unauthorised removal of actuator
- Various lengths available



101135339 - TAMPERPROOF SCREWS M 5 x 16

- To mount the actuator
- Higher protection against tampering with interlock
- Protects against unauthorised removal of actuator
- Various lengths available



101135340 - TAMPERPROOF SCREWS M 5 x 20

- To mount the actuator
- Higher protection against tampering with interlock
- Protects against unauthorised removal of actuator
- Various lengths available