

# STRONGUARD®

## Modular Guarding



Stronguard is some of the best guarding on the market. If you're looking for strength, modularity, and easy assembly, there is nothing quite like Stronguard. This design has been used for years and we're excited to share it with you.

## FEATURES INCLUDE



Bolted Corners



Stackable Posts



4" Floor Clearance



Mesh or Polycarbonate

**Stronguard** is a powder coated industrial guarding line built to solve two needs in automation and manufacturing:

**Modularity** – The design allows product to be stocked on the shelf and assembled quickly. No more waiting for custom guarding!

**Strength** – Stronguard was designed and manufactured with durability, longevity, and strength in mind. No more weak guarding in your plant!

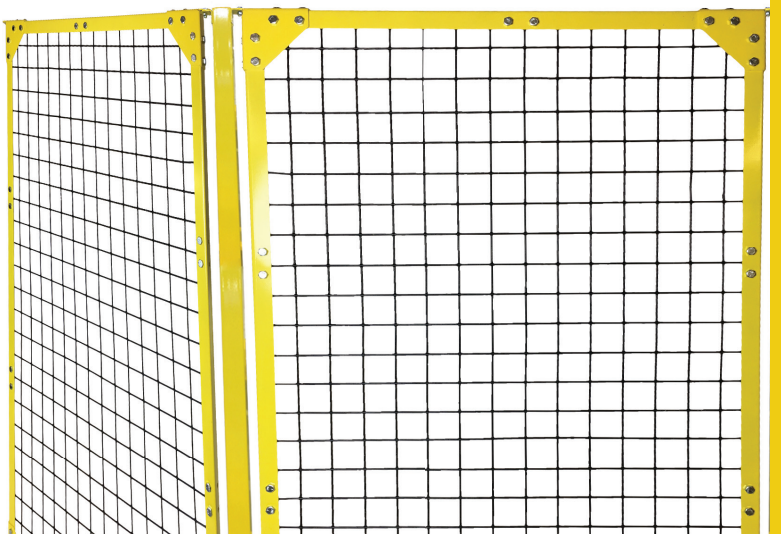

# HOW TO CHOOSE YOUR GUARDING

## Step 1. Measure Perimeter

First, figure out the total inches of guarding needed by measuring the perimeter of the area that's going to be guarded.

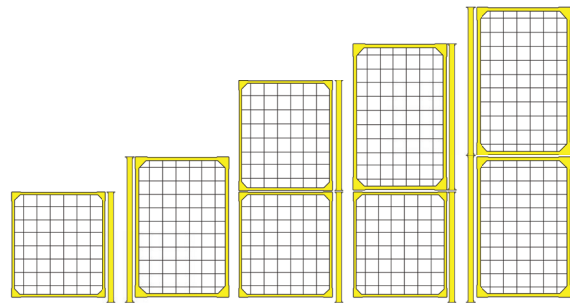
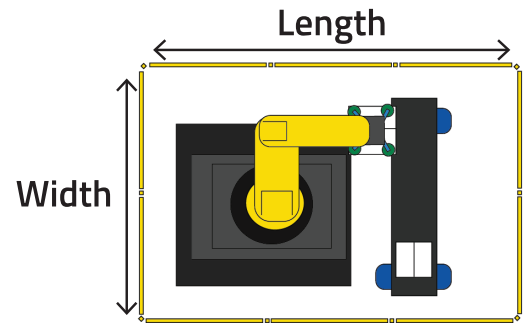

## Step 2. Post Height

Posts come in two different heights, Short and Tall.

Our posts and panels are stackable so two or three posts can be linked together for even taller guarding. Stack them as needed to achieve the desired height.

The post foot adds a floor sweep clearance of about 4 inches for easy cleanup of the guarded area.

## Step 3. Panel Width

Mix and match panels of various widths to get more exact lengths and protect your perimeter.

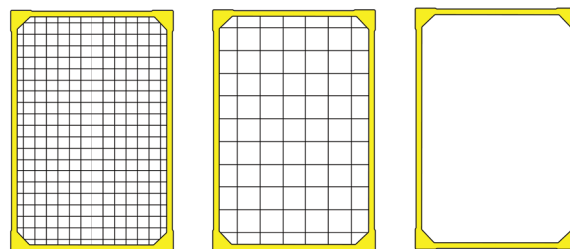
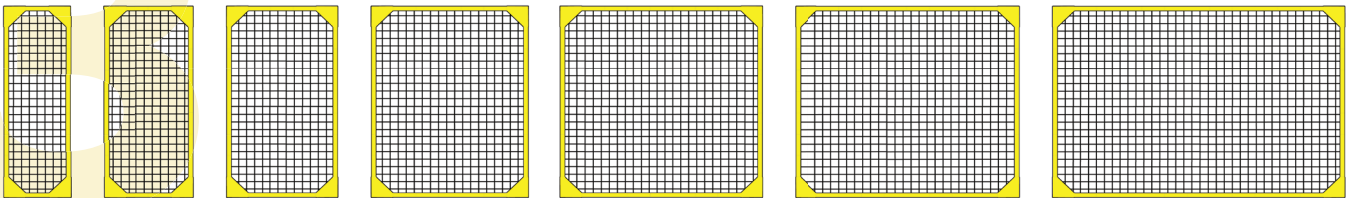

## Step 4. Panel Type

Panel Types Include:

- 1x1 Inch Mesh
- 2x2 Inch Mesh
- Polycarbonate

## Step 5. Door Options

You may choose from a swinging door or a sliding door.

We also have door conversion kits available to convert an existing Stronguard panel setup into a door.

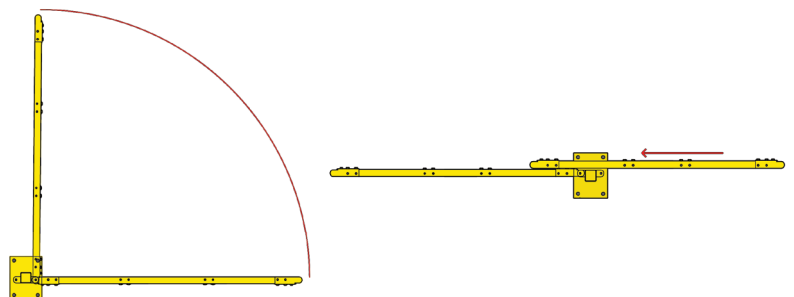

# PRODUCT CHART

PRODUCT CHART

SHORT PANELS						
Part #	Type	A	B	C	D	E
SG-0832P-22	2x2" Mesh	14"	11 3/4"	9 1/2"	10 1/4"	10 1/4"
SG-0832P-11	1x1" Mesh	14"	11 3/4"	9 1/2"	10 1/4"	10 1/4"
SG-0832P-P	Polycarbonate	14"	11 3/4"	9 1/2"	10 1/4"	10 1/4"
SG-1232P-22	2x2" Mesh	18"	15 3/4"	13 1/2"	14 1/4"	14 1/4"
SG-1232P-11	1x1" Mesh	18"	15 3/4"	13 1/2"	14 1/4"	14 1/4"
SG-1232P-P	Polycarbonate	18"	15 3/4"	13 1/2"	14 1/4"	14 1/4"
SG-1632P-22	2x2" Mesh	22"	19 3/4"	17 1/2"	18 1/4"	18 1/4"
SG-1632P-11	1x1" Mesh	22"	19 3/4"	17 1/2"	18 1/4"	18 1/4"
SG-1632P-P	Polycarbonate	22"	19 3/4"	17 1/2"	18 1/4"	18 1/4"
SG-2432P-22	2x2" Mesh	30"	27 3/4"	25 1/2"	26 1/4"	26 1/4"
SG-2432P-11	1x1" Mesh	30"	27 3/4"	25 1/2"	26 1/4"	26 1/4"
SG-2432P-P	Polycarbonate	30"	27 3/4"	25 1/2"	26 1/4"	26 1/4"
SG-3232P-22	2x2" Mesh	38"	35 3/4"	33 1/4"	34 1/4"	34 1/4"
SG-3232P-11	1x1" Mesh	38"	35 3/4"	33 1/4"	34 1/4"	34 1/4"
SG-3232P-P	Polycarbonate	38"	35 3/4"	33 1/4"	34 1/4"	34 1/4"
SG-3632P-22	2x2" Mesh	42"	39 3/4"	37 1/4"	38 1/4"	38 1/4"
SG-3632P-11	1x1" Mesh	42"	39 3/4"	37 1/4"	38 1/4"	38 1/4"
SG-3632P-P	Polycarbonate	42"	39 3/4"	37 1/4"	38 1/4"	38 1/4"
SG-4832P-22	2x2" Mesh	54"	51 3/4"	49 1/4"	50 1/4"	50 1/4"
SG-4832P-11	1x1" Mesh	54"	51 3/4"	49 1/4"	50 1/4"	50 1/4"
SG-4832P-P	Polycarbonate	54"	51 3/4"	49 1/4"	50 1/4"	50 1/4"

TALL PANELS						
Part #	Type	A	B	C	D	E
SG-0848P-22	2x2" Mesh	14"	11 3/4"	9 1/2"	10 1/4"	10 1/4"
SG-0848P-11	1x1" Mesh	14"	11 3/4"	9 1/2"	10 1/4"	10 1/4"
SG-0848P-P	Polycarbonate	14"	11 3/4"	9 1/2"	10 1/4"	10 1/4"
SG-1248P-22	2x2" Mesh	18"	15 3/4"	13 1/2"	14 1/4"	14 1/4"
SG-1248P-11	1x1" Mesh	18"	15 3/4"	13 1/2"	14 1/4"	14 1/4"
SG-1248P-P	Polycarbonate	18"	15 3/4"	13 1/2"	14 1/4"	14 1/4"
SG-1648P-22	2x2" Mesh	22"	19 3/4"	17 1/2"	18 1/4"	18 1/4"
SG-1648P-11	1x1" Mesh	22"	19 3/4"	17 1/2"	18 1/4"	18 1/4"
SG-1648P-P	Polycarbonate	22"	19 3/4"	17 1/2"	18 1/4"	18 1/4"
SG-2448P-22	2x2" Mesh	30"	27 3/4"	25 1/2"	26 1/4"	26 1/4"
SG-2448P-11	1x1" Mesh	30"	27 3/4"	25 1/2"	26 1/4"	26 1/4"
SG-2448P-P	Polycarbonate	30"	27 3/4"	25 1/2"	26 1/4"	26 1/4"
SG-3248P-22	2x2" Mesh	38"	35 3/4"	33 1/4"	34 1/4"	34 1/4"
SG-3248P-11	1x1" Mesh	38"	35 3/4"	33 1/4"	34 1/4"	34 1/4"
SG-3248P-P	Polycarbonate	38"	35 3/4"	33 1/4"	34 1/4"	34 1/4"
SG-3648P-22	2x2" Mesh	42"	39 3/4"	37 1/4"	38 1/4"	38 1/4"
SG-3648P-11	1x1" Mesh	42"	39 3/4"	37 1/4"	38 1/4"	38 1/4"
SG-3648P-P	Polycarbonate	42"	39 3/4"	37 1/4"	38 1/4"	38 1/4"
SG-4848P-22	2x2" Mesh	54"	51 3/4"	49 1/4"	50 1/4"	50 1/4"
SG-4848P-11	1x1" Mesh	54"	51 3/4"	49 1/4"	50 1/4"	50 1/4"
SG-4848P-P	Polycarbonate	54"	51 3/4"	49 1/4"	50 1/4"	50 1/4"

POSTS & FEET	
Part #	Description
SG-32POST	Modular Short Post Section
SG-48POST	Modular Tall Post Section
SG-FOOT	Modular Post Foot Pad

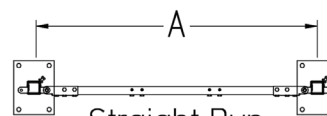

Straight Run

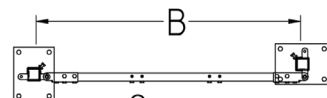

Corner

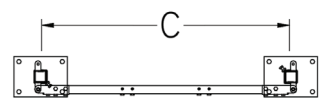

U-Turn

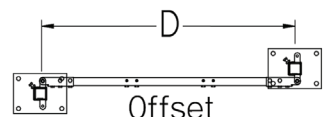

Offset

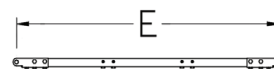

Without Posts

SWINGING DOOR KITS		
Part #	Type	A
SG-3232SW-32DK22	Dual short w/ 2x2" Mesh	38"
SG-3232SW-32DK11	Dual short w/ 1x1" Mesh	38"
SG-3232SW-32DKP	Dual short w/ Polycarbonate	38"
SG-4832SW-32DK22	Tall/short w/ 2x2" Mesh	38"
SG-4832SW-32DK11	Tall/short w/ 1x1" Mesh	38"
SG-4832SW-32DKP	Tall/short w/ Polycarbonate	38"
SG-4848SW-32DK22	Dual tall w/ 2x2" Mesh	38"
SG-4848SW-32DK11	Dual tall w/ 1x1" Mesh	38"
SG-4848SW-32DKP	Dual tall w/ Polycarbonate	38"
SG-3232SW-48DK22	Dual short w/ 2x2" Mesh	54"
SG-3232SW-48DK11	Dual short w/ 1x1" Mesh	54"
SG-3232SW-48DKP	Dual short w/ Polycarbonate	54"
SG-4832SW-48DK22	Tall/short w/ 2x2" Mesh	54"
SG-4832SW-48DK11	Tall/short w/ 1x1" Mesh	54"
SG-4832SW-48DKP	Tall/short w/ Polycarbonate	54"
SG-4848SW-48DK22	Dual tall w/ 2x2" Mesh	54"
SG-4848SW-48DK11	Dual tall w/ 1x1" Mesh	54"
SG-4848SW-48DKP	Dual tall w/ Polycarbonate	54"

SWINGING DOOR CONVERSION KITS		
Part #	Type	A
SG-3232SW-32CK22	Dual short w/ 2x2" Mesh	38"
SG-3232SW-32CK11	Dual short w/ 1x1" Mesh	38"
SG-3232SW-32CKP	Dual short w/ Polycarbonate	38"
SG-4832SW-32CK22	Tall/short w/ 2x2" Mesh	38"
SG-4832SW-32CK11	Tall/short w/ 1x1" Mesh	38"
SG-4832SW-32CKP	Tall/short w/ Polycarbonate	38"
SG-4848SW-32CK22	Dual tall w/ 2x2" Mesh	38"
SG-4848SW-32CK11	Dual tall w/ 1x1" Mesh	38"
SG-4848SW-32CKP	Dual tall w/ Polycarbonate	38"
SG-3232SW-48CK22	Dual short w/ 2x2" Mesh	54"
SG-3232SW-48CK11	Dual short w/ 1x1" Mesh	54"
SG-3232SW-48CKP	Dual short w/ Polycarbonate	54"
SG-4832SW-48CK22	Tall/short w/ 2x2" Mesh	54"
SG-4832SW-48CK11	Tall/short w/ 1x1" Mesh	54"
SG-4832SW-48CKP	Tall/short w/ Polycarbonate	54"
SG-4848SW-48CK22	Dual tall w/ 2x2" Mesh	54"
SG-4848SW-48CK11	Dual tall w/ 1x1" Mesh	54"
SG-4848SW-48CKP	Dual tall w/ Polycarbonate	54"

ACCESSORIES	
Part #	Description
SG-LCM-32	Short Light Curtain
SG-LCM-48	Tall Light Curtain
SG-DL-XXXX	Door Interlock - See website
SG-SLIDING-DK	A door kit for converting panels into a sliding door. Because of the way the sliding door is designed, this one kit will convert any panel section into a sliding door.

Final measurements for all swinging door kits are the same as the panel they replace.

Stronguard's design also makes it easy to add your own wireway, piping, or other accessories to the top of the posts.

# TECHNICAL INFORMATION

