

D12FPH Series DIN Rail High Power Fiber Optic Sensors

Very high power sensors for use with plastic fiber optic assemblies

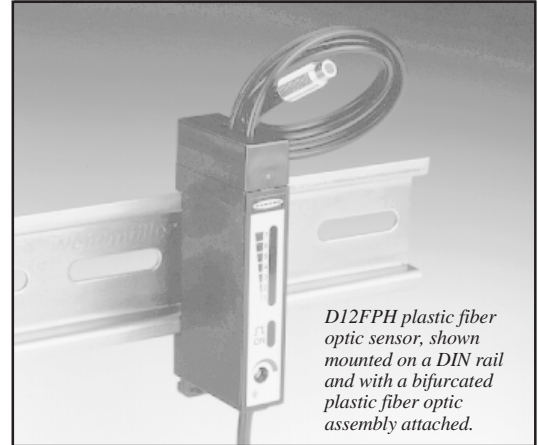

- Plastic fiber optic sensors for DIN rail mounting
- Highest optical power available in a plastic fiber optic sensor
- Visible red light source; for use with Banner cut-to-length plastic fiber optic assemblies
- Choice of either NPN (current sinking) or PNP (current sourcing) complementary output models; 150 mA maximum (continuous) load
- Normally closed output may be wired as a diagnostic alarm output, depending upon hookup to power supply*; 10-30V dc operation.
- LED indicators for POWER ON and N.O. OUTPUT CONDUCTING
- Patented 7-segment moving-dot LED bargraph[†] shows received signal strength, OUTPUT OVERLOAD, MARGINAL EXCESS GAIN



D12FPH plastic fiber optic sensor, shown mounted on a DIN rail and with a bifurcated plastic fiber optic assembly attached.

Description

D12FPH Series sensors are compact, totally self-contained visible-red fiber optic sensors for DIN rail mounting. D12FPH Series sensors are designed for use with Banner cut-to-length plastic fiber optic assemblies. They may be used in the opposed and diffuse fiber optic sensing modes. D12FPH Series sensors have the highest optical power available in a plastic fiber optic sensor.

D12s operate from 10-30V dc and draw 45 mA maximum, exclusive of load current. Models are available with a choice of NPN or PNP complementary outputs (one output normally open, one output normally closed). The normally closed output of all models may be used as a diagnostic alarm output, depending upon the hookup of the sensor to the power supply*. All models are available with either an attached cable or a 6" pigtail with a pico-style quick disconnect connector. A complete listing of models is given on page 2.

Each output is capable of 150 mA continuous load. The choice of NPN (sinking) or PNP (sourcing) models enables D12 sensors to interface to a wide variety of loads.

Two top-mounted LED indicators (see drawing, right) light to indicate POWER ON and NORMALLY OPEN OUTPUT CONDUCTING conditions.

A highly-visible red 7-segment moving-dot LED bargraph[†] (right) lights to indicate the relative strength of the received light signal. This feature can greatly simplify sensitivity adjustment and the task of fiber optic alignment, as well as provide a constant reference over time for overall sensing system performance. Also, segment #1 of the bargraph flashes to indicate an output overload, and segment #7 flashes to indicate marginal excess gain. A flashing LED corresponds to the "on" state of the D12's alarm output.

D12s have a 15-turn SENSITIVITY control, with a slotted brass screw clutched at both ends of travel.

D12FPH Series sensors may be used with either the small diameter (.020") or large diameter (.040") Banner cut-to-length plastic fibers.

See page 4 for sensor dimension drawings. D12 Sensors mount directly to a standard DIN rail. They may also be through-hole mounted to a surface using the supplied bracket (see page 4) and stainless steel M3 x 0,5 mounting hardware.

D12s are constructed of rugged black ABS (Cyclocac[®] KJB). The transparent housing cover is acrylic. D12FPH Series sensors are rated NEMA 4.

*U.S. Patent #5087838 †U.S. Patent #4965548



WARNING D12FPH Series sensors do NOT include the self-checking redundant circuitry necessary to allow their use in personnel safety applications. A sensor failure or malfunction can result in either an energized or a de-energized sensor output condition.

Never use these products as sensing devices for personnel protection. Their use as safety devices may create an unsafe condition which could lead to serious injury or death.

Only MINI-SCREEN[®], MULTI-SCREEN[®], MICRO-SCREEN[™], MACHINE-GUARD[™] and PERIMETER-GUARD[™] Systems, and other systems so designated, are designed to meet OSHA and ANSI machine safety standards for point-of-operation guarding devices. No other Banner sensors or controls are designed to meet these standards, and they must NOT be used as sensing devices for personnel protection.

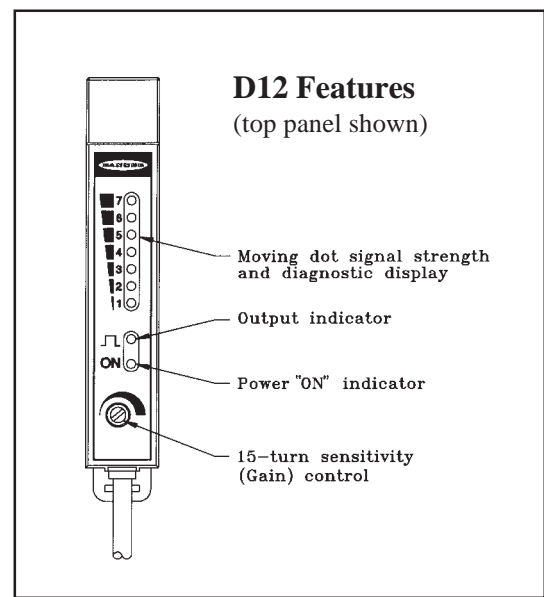

D12FPH Series DIN RAIL Fiber Optic Sensors

Specifications, D12FPH Series sensors

Sensing range: see individual excess gain curves, page 3.

Sensing beam: visible red, 660 nanometers.

Supply voltage: 10 to 30V dc at 45 mA max, exclusive of load. Protected against reverse polarity and inductive load transients.

Sensor model listing and output configurations:

Solid-state dc outputs:

D12SN6FPH NPN sinking complementary outputs, attached cable.

D12SN6FPHQ NPN sinking complementary outputs, 6-inch pigtail with pico-style QD.

D12SP6FPH PNP sourcing complementary outputs, attached cable.

D12SP6FPHQ PNP sourcing complementary outputs, 6-inch pigtail with pico-style QD.

The N.C. (normally closed) output may be used as an alarm output, depending upon the hookup to the power supply.

Output rating: 150 mA maximum each output. No false pulse on power-up. (False pulse protection circuit causes a 20 millisecond delay on power-up.) Short-circuit protected.

Off-state leakage current <10 microamps at 30V dc.

On-state saturation voltage <1V at 10 mA dc; <1.5V at 150 mA dc.

The total load may not exceed 150 mA.

Response time: .5 millisecond "on"; .5 millisecond "off".

Repeatability is 130 microseconds.

Response time and repeatability are independent of signal strength.

Indicators: Two top-mounted LED indicators, one yellow and one green, and one 7-segment red LED moving-dot bargraph.

GREEN LED lights to indicate DC POWER ON.

YELLOW LED lights to indicate NORMALLY OPEN OUTPUT CONDUCTING.

7-segment moving dot red LED bargraph lights to indicate relative received light signal strength. In addition, segment #1 flashes to indicate OUTPUT OVERLOAD, and segment #7 flashes to indicate MARGINAL EXCESS GAIN (a "dark" signal that lights LED #2 for at least one second, or a "light" signal that lights LED #3 for at least one second). A flashing LED corresponds to the "on" state of the alarm output. See page 1 for further description.

Adjustments: SENSITIVITY control on top of module (15-turn slotted brass screw, clutched at both ends of adjustment).

Construction: Black ABS (Cyclocac® KJB) housing with acrylic cover. Rated NEMA 4. The fiber clamping element is Delrin®.

Cable: 6-1/2-foot long (2 meter) attached PVC-covered cable* or 6-inch pigtail with pico-style 4-pin QD connector. Use mating cable model PKG4-2 (straight connector) or PKW4-2 (right angled); 6-1/2 feet (2 m) long. *Models also available with 30 ft (9 m) attached cable.

Mounting bracket: D12 Series sensors mount directly to a standard DIN rail, or may be through-hole mounted using the supplied mounting bracket and M3 x 0,5 stainless steel hardware. Bracket material is black VALOX®.

Operating temperature range: -20° to +70°C (-5° to +158°F).

Maximum relative humidity 90% at 50°C (non-condensing).

Application caution...

D12 Series sensors are designed to deliver very high optical energy (excess gain). They should **not** be used for applications which offer low optical contrast (i.e. only a small difference in received light levels between the light and dark sensing conditions). Examples include diffuse mode sensing of objects in front of a reflective background and opposed mode sensing of non-opaque materials.

D12 sensors excel in applications requiring high excess gain (e.g. for long-range sensing, sensing with long fiber lengths, diffuse sensing of materials with low reflectivity, etc.)

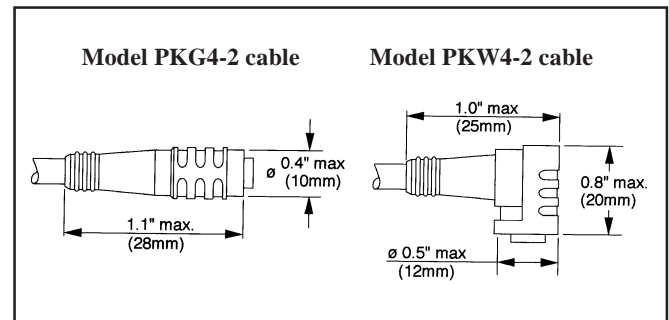

Hookup Diagrams, D12FPH Series Sensors

Sinking (NPN) Standard Hookup

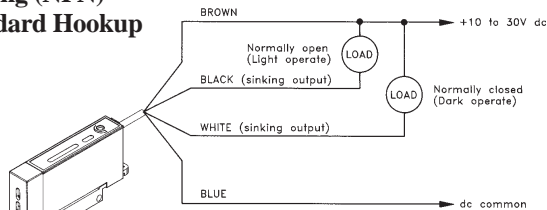

Note: Use model PKG4-2 cable for "Q" model sensors (ordered separately)

Sinking (NPN) Alarm Hookup

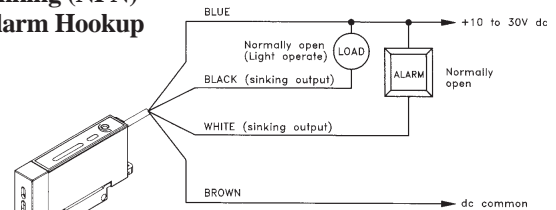

Note: Use model PKG4-2 cable for "Q" model sensors (ordered separately)

Sourcing (PNP) Standard Hookup

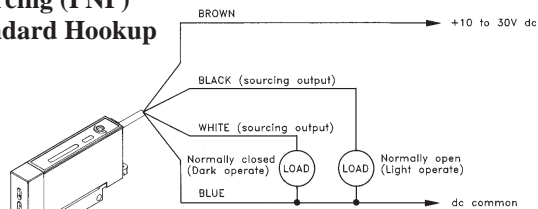

Note: Use model PKG4-2 cable for "Q" model sensors (ordered separately)

Sourcing (PNP) Alarm Hookup

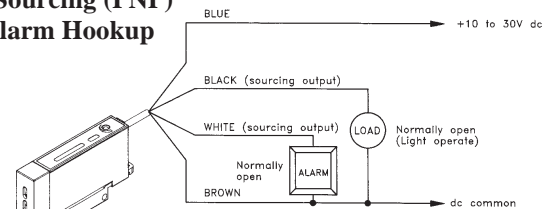

Note: Use model PKG4-2 cable for "Q" model sensors (ordered separately)

D12FPH Series DIN RAIL Fiber Optic Sensors

Model range and gain information for D12FPH Series sensors

The following D12 models are available for use with plastic fiber optics:*

- D12SN6FPH** p/n 34464 NPN sinking complementary outputs, 6-1/2 foot attached cable.
- D12SN6FPHQ** p/n 34973 NPN sinking complementary outputs, 6-inch pigtail with pico-style QD.
- D12SP6FPH** p/n 34972 PNP sourcing complementary outputs, 6-1/2 foot attached cable.
- D12SP6FPHQ** p/n 34974 PNP sourcing complementary outputs, 6-inch pigtail with pico-style QD.

*Models with 30-foot attached cable are also available.

Diffuse Sensing Mode

Excess gain curves for bifurcated plastic fibers in the diffuse sensing mode are given at the right. Fiber sizes are noted on the curves.

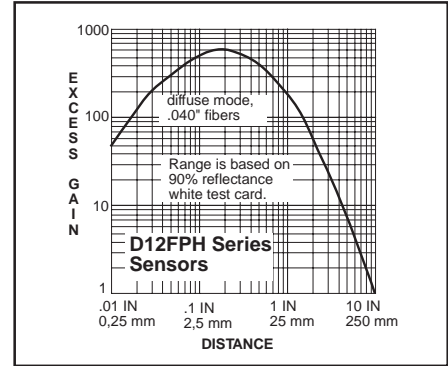
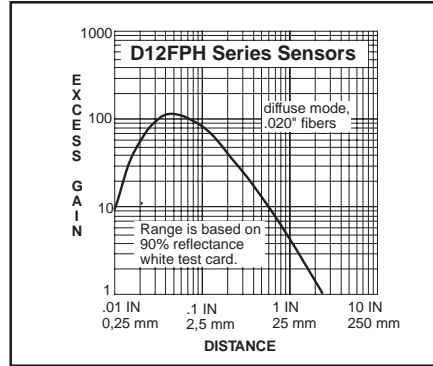

Opposed Sensing Mode

Excess gain curves for individual plastic fibers in the opposed sensing mode (without lenses) are given at the right. Fiber sizes are noted on the curves.

The curve at the lower near right shows the performance of two individual unterminated .040" dia. plastic fibers, each fitted with a model L08FP lens (shown below, sold separately). The curve at the lower far right shows the performance of two individual threaded .040" dia. plastic fibers (PIT4 Series), each fitted with a model L2 lens (below, sold separately). Note that, in both lensed situations, the curves stop at 10 feet separation (the maximum practical separation of the sensing ends for a pair of 6-foot single fibers).

A pair of 6-foot cut-to-length individual plastic fibers with factory-installed L08FP lenses is also available. Order plastic fiber assembly model PIL46U.

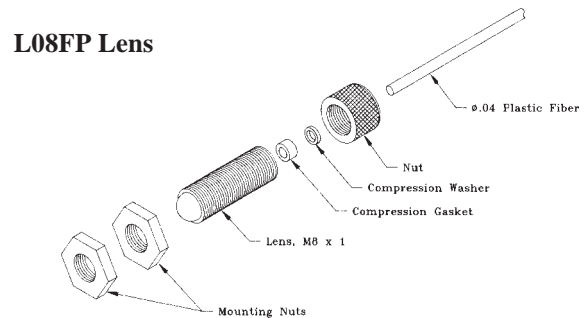
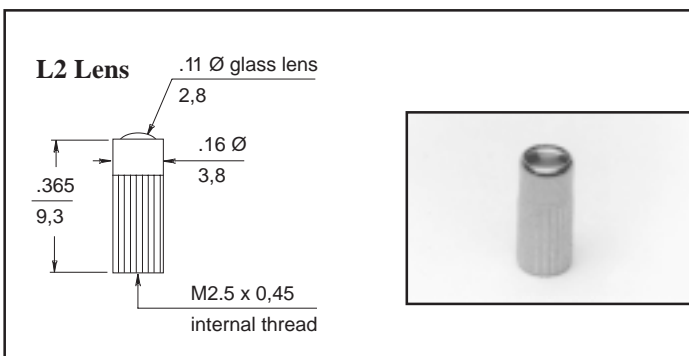
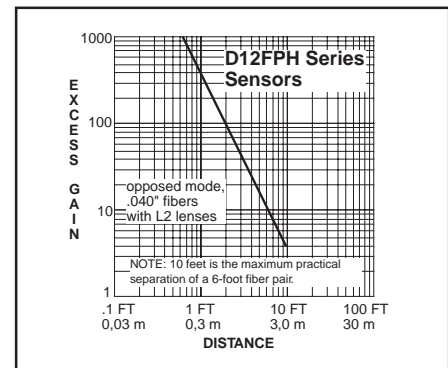
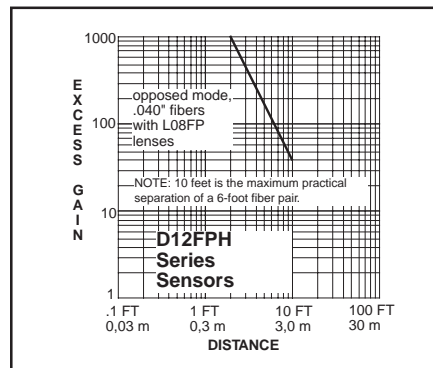
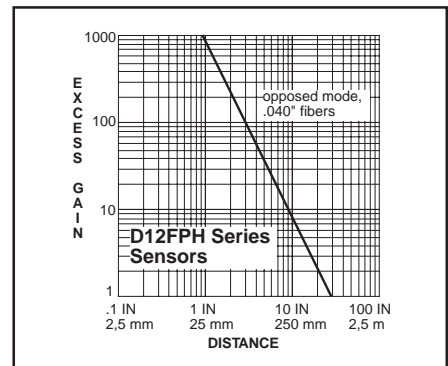
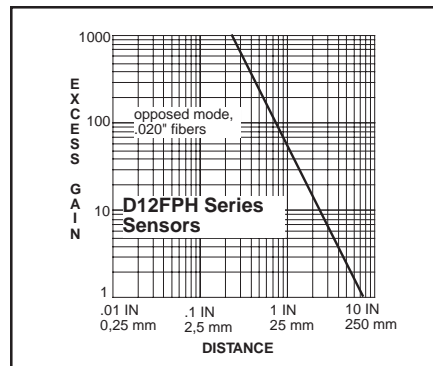

D12FPH Series DIN RAIL Fiber Optic Sensors

D12FPH Dimensions and Features

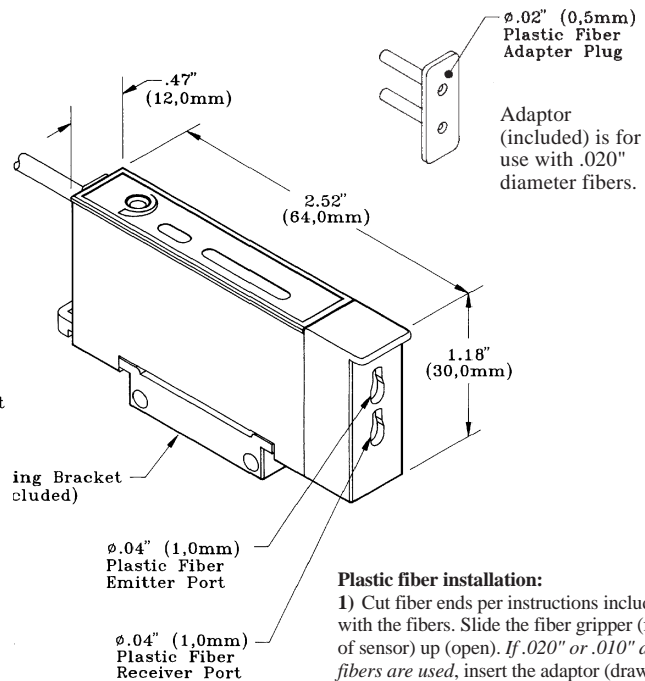
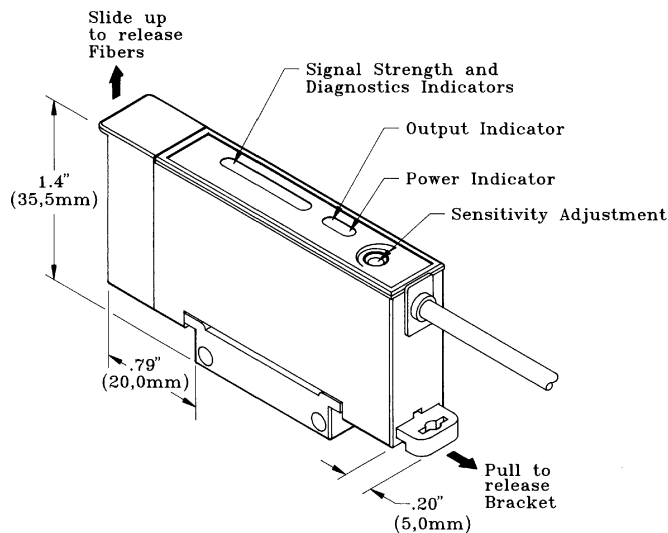

Adaptor (included) is for use with .020" diameter fibers.

Plastic fiber installation:

- 1) Cut fiber ends per instructions included with the fibers. Slide the fiber gripper (front of sensor) up (open). If .020" or .010" dia. fibers are used, insert the adaptor (drawing above) into the ports as far as it will go.
- 2) All fibers: Insert the prepared plastic fiber sensor ends gently into the ports as far as they will go. Slide the fiber gripper back down to lock.

D12 Bracket Dimensions

For through-hole mounting of all models; stainless steel hardware included.

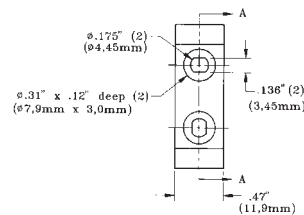
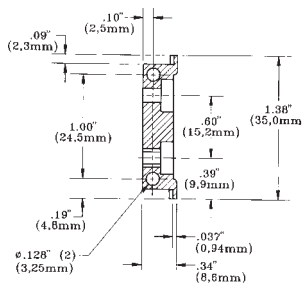
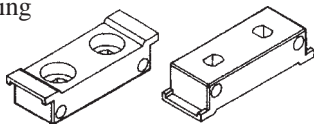

WARRANTY: Banner Engineering Corporation warrants its products to be free from defects for one year. Banner Engineering Corporation will repair or replace, free of charge, any product of its manufacture found to be defective at the time it is returned to the factory during the warranty period. This warranty does not cover damage or liability for the improper use of Banner products. This warranty is in lieu of any other warranty either expressed or implied.