



QM42 Series 150 Adjustable Field Sensors

Sensing Cutoff Point is Adjustable from 50 to 150 mm (2 to 6 in)



Features

- Adjustable field technology allows direct detection of objects within a defined sensing field, while completely ignoring reflective objects located beyond the sensing field cutoff point
- Reliable *electronic* adjustment* of sensing field cutoff point from 50 to 150 mm; no mechanical adjustments to worry about
- Compact, rugged, low cost self-contained sensors in metal die cast housings
- Epoxy-encapsulated circuitry; leakproof IP67 (NEMA 6) construction for reliable sensing in harsh environments
- Outstanding electrical noise immunity
- Dual LED system indicates sensor performance
- Choice of integral cable or quick disconnect connector

* Patent Pending

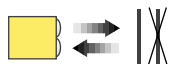

Visible Red, 680 nm



QM42 150mm Adjustable Field Mode

Models	Range	Cutoff Point	Cable	Supply Voltage	Output Type	Cutoff Point Deviation
QM42VN6AFV150 QM42VN6AFV150Q	5 mm (0.2 in) to Cutoff point	50 to 150 mm (2 to 6 in)	2 m (6.5 ft)	10-30V dc	NPN	
4-pin Euro QD						
QM42VP6AFV150 QM42VP6AFV150Q	2 m (6.5 ft)	PNP				
4-pin Euro QD						

Interpretation of Performance Curves

The percentage of deviation indicates a change in the cutoff point for either 18% gray or 6% black targets, relative to the cutoff point set for a 90% reflective white test card.

As an example, the cutoff point decreases 10% for a 6% reflectance black target when the cutoff point is adjusted for 150 millimeters (6 inches) using a 90% reflectance white test card. In other words, the cutoff point for the black target is 135 millimeters (5.3 inches) for this setting.

QM42 Series 150 mm Adjustable Field Sensors

Adjustable Field Sensing - Theory of Operation

The receiver element of an adjustable field sensor produces two currents: I_1 and I_2 . The *ratio* of these two currents changes as the received light signal moves along the length of the receiver element (see Figure 1). The sensing cutoff distance relates directly to this ratio, which can be adjusted using the sensor's multi-turn potentiometer.

The cutoff distance for model QM42...AFV150 sensors is adjustable from 50 to 150 millimeters (2 to 6 inches). Objects lying beyond the cutoff distance are ignored, even if they are highly-reflective.

However, it is possible to falsely detect a background object, if it is positioned as shown in Figure 3, or if it moves past the face of the sensor in a direction which is perpendicular to the sensing axis (Figures 2 and 3). To solve this problem, rotate the sensor 90 degrees, as shown in Figure 4.

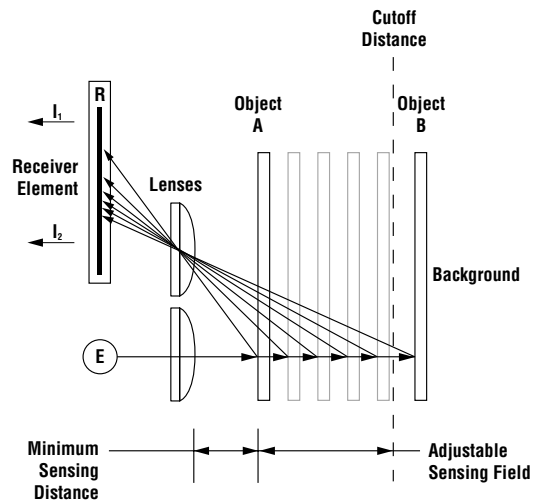
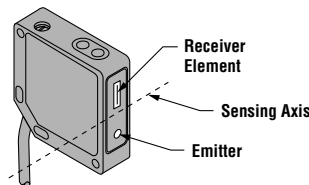

Figure 1: Adjustable Field Sensing Concept



As a general rule, the most reliable sensing of an object which approaches from the side occurs when the line of approach is parallel to the sensing axis.

Figure 2: Sensing Axis

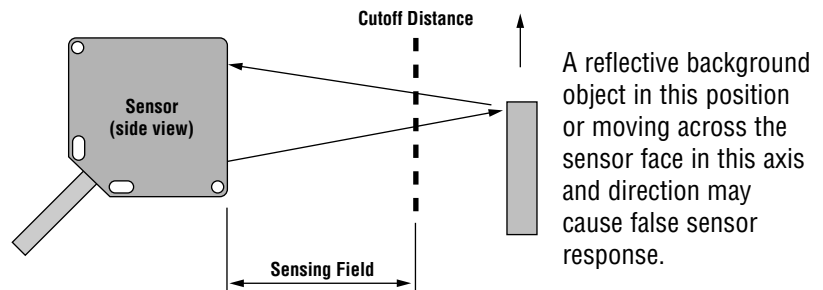

Figure 3: Object Beyond Cutoff Distance - Problem

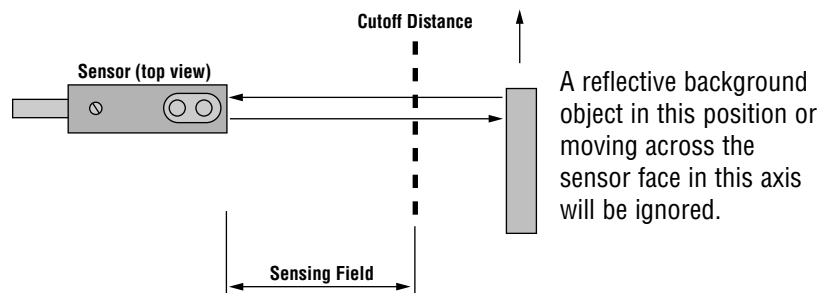



Figure 4: Object Beyond Cutoff Distance - Solution

QM42 Series 150 mm Adjustable Field Sensors

Product Specifications	
Sensing Beam	Visible Red, 680 nm
Supply Voltage and Current	10 to 30V dc (10% maximum ripple) at less than 50 milliamps
Supply Protection Circuitry	Protected against reverse polarity and transient voltages
Output Configuration	SPDT (complementary) solid-state dc switch; Choose NPN (current sinking) or PNP (current sourcing) models. <i>Light operate:</i> N.O. output conducts when the sensor sees its own (or the emitter's) modulated light <i>Dark operate:</i> N.C. output conducts when the sensor sees dark
Output Rating	100 mA maximum (each output) Off-state leakage current: <5 microamps at 30V dc; On-state saturation voltage: <1V at 10 mA dc; <1.5V at 100 mA dc
Output Protection Circuitry	Protected against false pulse on power-up and continuous overload or short-circuit of outputs Overload trip point ≥ 150 mA, typical, at 20°C
Output Response Time	1 millisecond on and off
Repeatability of Response	250 microseconds
Sensing Hysteresis	Less than 7% of set cutoff distance
Adjustments	All models except emitters: 12-turn slotted brass cutoff distance adjustment potentiometer (clutched at both ends of travel)
Indicators	Two LEDs: Green and Yellow GREEN glowing steadily = power to sensor is "on" GREEN flashing = output is overloaded YELLOW glowing steadily = light is sensed; normally open output "on" YELLOW flashing = marginal excess gain (1-1.5x) in light condition
Construction	Housings are die-cast zinc alloy with black acrylic polyurethane paint finish; lenses are acrylic
Environmental Rating	IP67; NEMA 6
Connections	2 m (6-1/2 ft) or 9 m (30-ft) attached cable, or 4-pin euro-style quick-disconnect fitting; Cables for QD models are purchased separately
Operating Temperature	-20° to +55°C (-7° to 130°F); Maximum relative humidity 90% at 50°C (non-condensing)
Certifications	

QM42 Series 150 mm Adjustable Field Sensors

Dimensions

Cabled models

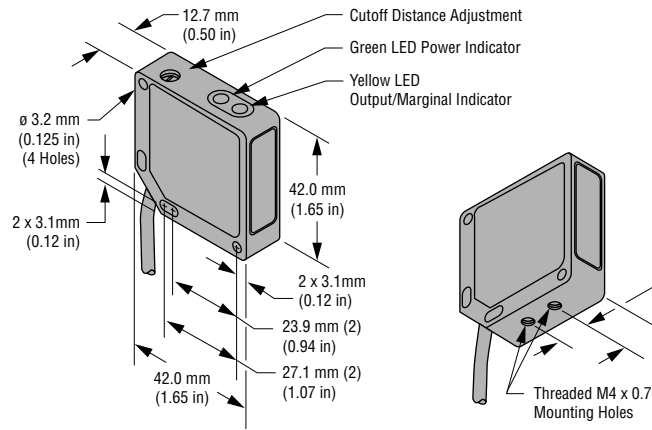

Quick-disconnect models

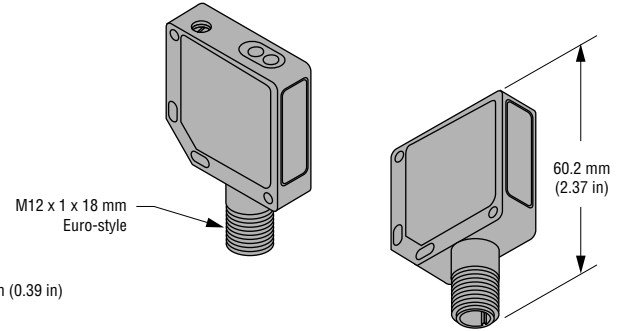

Hookup Diagrams

Sensors with NPN (Sinking) Outputs

Cabled Models

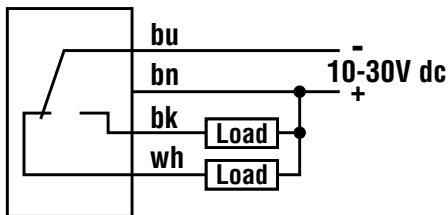

Quick Disconnect Models

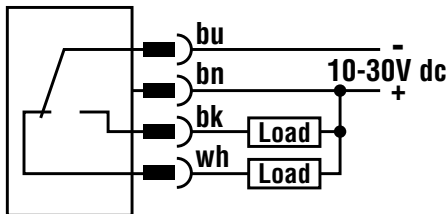

Sensors with PNP (Sourcing) Outputs

Cabled Models

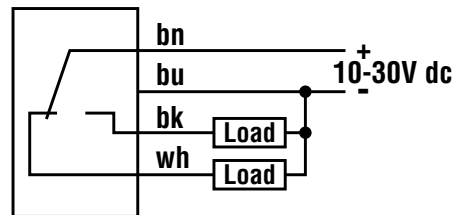

Quick Disconnect Models

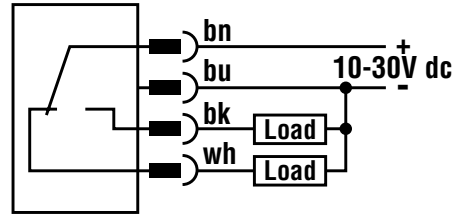

QM42 Series 150 mm Adjustable Field Sensors

Quick Disconnect (QD) Cables

The following is the selection of cables available for the QM42 QD models

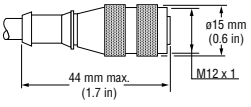
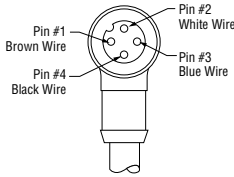
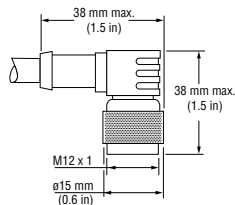
Style	Model	Length	For use with	Dimensions	Pinout
4-pin Euro Style straight	MQDC-406 MQDC-415 MQDC-430	2 m (6.5 ft) 5 m (15 ft) 9 m (30 ft)	All QM42 sensors with quick-disconnect fitting		
4-pin Euro Style right-angle	MQDC-406RA MQDC-415RA MQDC-430RA	2 m (6.5 ft) 5 m (15 ft) 9 m (30 ft)			

Mounting Brackets

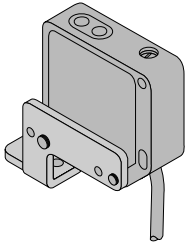
Model	Description
SMB19	Right-angle, stainless steel, mounting bracket (M3 mounting hardware is supplied)
SMB42F	<ul style="list-style-type: none"> • 13 gauge stainless steel • Hardware included 

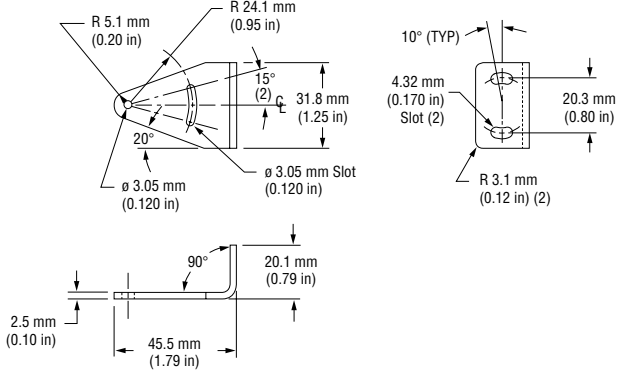

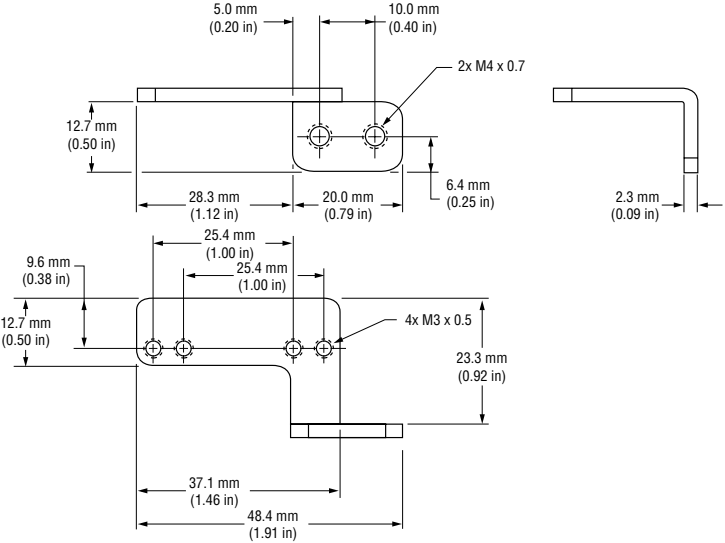

QM42 Series 150 mm Adjustable Field Sensors

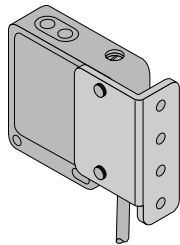
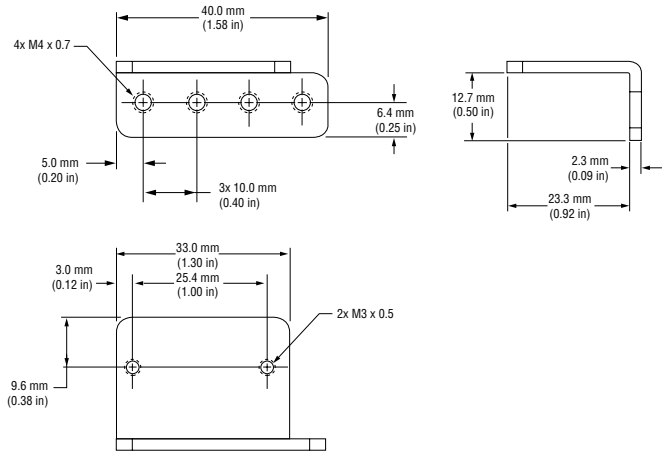
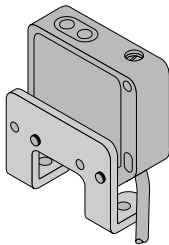
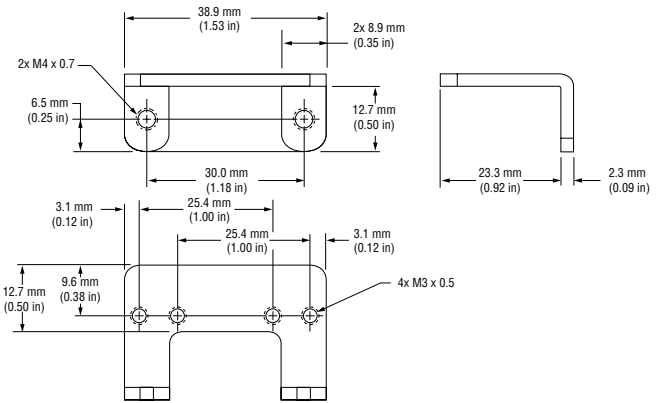
Mounting Brackets		
Model	Description	
SMB42L  <ul style="list-style-type: none"> • 13 gauge stainless steel • Hardware included 		
SMB42U  <ul style="list-style-type: none"> • 13 gauge stainless steel • Hardware included 		

WARRANTY: Banner Engineering Corporation warrants its products to be free from defects for one year. Banner Engineering Corporation will repair or replace, free of charge, any product of its manufacture found to be defective at the time it is returned to the factory during the warranty period. This warranty does not cover damage or liability for the improper application of Banner products. This warranty is in lieu of any other warranty either expressed or implied.



WARNING These photoelectric presence sensors do NOT include the self-checking redundant circuitry necessary to allow their use in personnel safety applications. A sensor failure or malfunction can result in either an energized or a de-energized sensor output condition.

Never use these products as sensing devices for personnel protection. Their use as a safety device may create an unsafe condition which could lead to serious injury or death.

Only MINI-SCREEN®, MULTI-SCREEN®, MICRO-SCREEN™, MACHINE-GUARD™ and PERIMETER-GUARD™ Systems, and other systems so designated, are designed to meet OSHA and ANSI machine safety standards for point-of-operation guarding devices. No other Banner sensors or controls are designed to meet these standards, and they must NOT be used as sensing devices for personnel protection.