

# MAXI-BEAM<sup>®</sup> Fixed-field Sensor Heads

Models RSBFF50 and RSBFF100, with sharp far-limit cutoff



the photoelectric specialist

- Fixed-field proximity mode sensor heads for use with MAXI-BEAM<sup>®</sup> power blocks
- Two models provide sharp, accurate far-limit cutoff of 50 or 100 mm
- Ideal for detecting a part or surface that is only a fraction of an inch in front of another surface
- Top-mounted LED indicator warns of low excess gain
- Sensor heads are rotatable in 90 degree increments
- Rotatable programming ring for selection of light- or dark-operate sensing

## Introduction: MAXI-BEAM<sup>®</sup> System

Banner MAXI-BEAM<sup>®</sup> sensors are highly versatile, self-contained, modularized photoelectric sensing controls that are ideally suited to industrial environments. The fixed-field MAXI-BEAM is an ON/OFF switch consisting of three modules (*sensor head, power block, and wiring base*). A unique, patented, rotatable "programming ring" enables you to program your choice of "light" or "dark" operate mode (photo, page 4). The sensing beam has a wavelength of 880 nanometers (infrared).

Interchangeable MAXI-BEAM<sup>®</sup> sensor heads are rotatable in 90-degree increments around the vertical axis and are also available in retroreflective, diffuse, opposed, convergent, and fiberoptic sensing modes.

Each MAXI-BEAM sensor head requires a compatible power block and a wiring base. The power block interfaces the sensor head to the circuit to be controlled. Sensor head models RSBFF50 and RSBFF100 may be used only with the MAXI-BEAM power blocks listed on page 2 of this data sheet. The plug-in design of the model RWB4 wiring base enables easy exchange of the entire sensing electronics without disturbing field wiring.

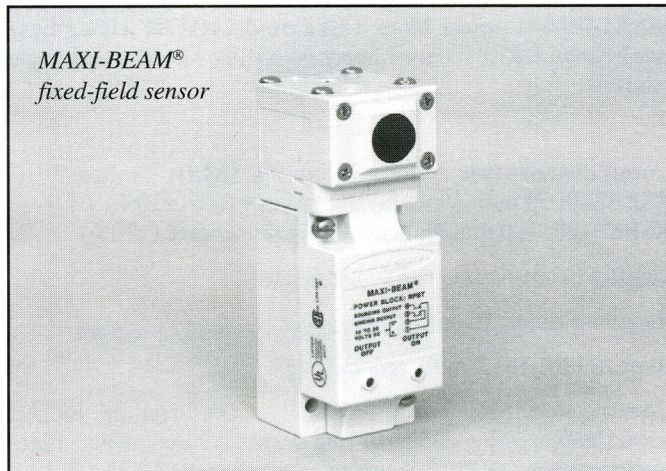

RSBFF sensor heads have a convenient dual-purpose top-mounted red LED indicator that lights whenever an object is detected in the fixed sensing field. Also, this LED flashes whenever the sensor's excess gain in the light condition drops below 1.5x.

MAXI-BEAM sensors are ruggedly constructed of molded VALOX<sup>®</sup> to conform to NEMA standards 1, 3, 4, 12, and 13, and have replaceable molded acrylic lenses. Sensor head, power block, and wiring base simply snap and bolt together, with no interwiring necessary (see photo, page 4). Module interfaces are o-ring and quad-ring sealed for the ultimate in dust, dirt, and moisture resistance. The operating temperature range is -40 to +70 degrees C (-40 to +158 degrees F).

NOTE: RSBFF sensor heads may not be used with 2-wire ac power blocks, and are not for use with MAXI-BEAM logic modules.

## Theory of Fixed-field Sensing

MAXI-BEAM fixed-field sensor heads have high excess gain which enables them to detect objects of low reflectivity, and sharp cutoff that helps them to ignore backgrounds lying beyond their far-limit cutoff distance of 50 mm (2 inches, RSBFF50 models) or 100 mm (4 inches, RSBFF100 models). These sensors are ideal for detecting a part or surface that is only a fraction of an inch in front of another surface.

In operation, the RSBFF sensor head compares the reflections of its emitted light beam (E) from an object back to the sensor's two differently-aimed detectors R1 and R2 (drawing at left). If the near detector (R1) light signal is stronger than the far detector (R2) light signal (object A closer than the cutoff distance), the sensor's output is "on". If the far detector (R2) light signal is stronger than the near detector (R1) light signal (object B beyond the cutoff distance), the sensor's output is "off". At the cutoff distance (dashed line), the signals from the two detectors are equal.

Orientation of the two sensor fields (and therefore of the sensor itself) with respect to the object or the background can be important for some applications (see discussion, page 3).

Figure 1. Fixed-field Concept

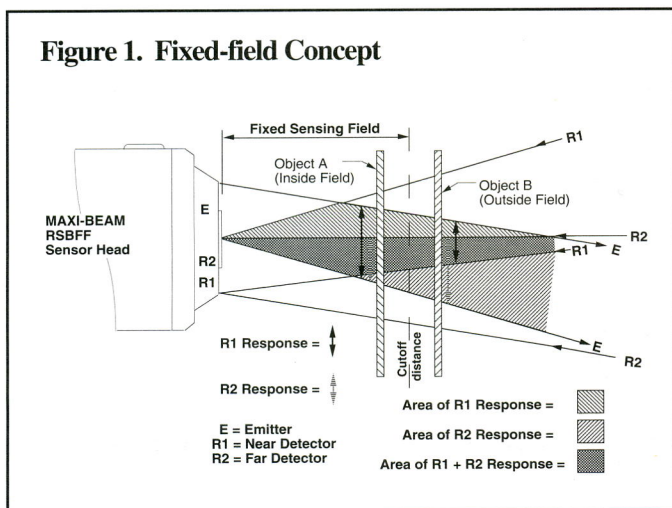

## Specifications, MAXI-BEAM® Fixed-field Sensors

(See page 4 for Dimension Drawing)

**NOTE:** Every RSBFF50 or RSBFF100 sensor head requires a MAXI-BEAM power block and a model RWB4 wiring base (see below). RSBFF sensor heads *do not* use MAXI-AMP logic modules.

**Cutoff distance (see excess gain curves, right):**

**RSBFF50:** 50 mm (2 inches) from sensor face ( $\pm 10\%$ )

**RSBFF100:** 100 mm (4 inches) from sensor face ( $\pm 10\%$ )

**Sensing beam:** infrared, 880 nanometers.

**Response time:** 10 milliseconds.

**Repeatability:** 3.3 milliseconds.

**Construction:** Reinforced molded VALOX® housing, molded acrylic lenses, o-ring and quad-ring gasketed components. Electronic components are fully epoxy encapsulated. NEMA 1, 3, 4, 12, and 13.

**Operating temperature:** -40 to +70°C (-40 to +158°F).

**LED indicator:** Red indicator LED on top of sensor head lights whenever an object is detected in the fixed sensing field, and flashes when excess gain in the light condition falls below 1.5x.

**Programming ring:** For selection of light- or dark-operate output. Programming ring is included with the sensor head.

**False Pulse Suppression on Power-up:** all models.

**Power requirements:** MAXI-BEAM sensor heads obtain their operating voltage through MAXI-BEAM power blocks. *Only the following listed power block models may be used with the model RSBFF50 and RSBFF100 sensor heads.* See data sheet P/N 03418 or the Banner product catalog for a complete description of power blocks and specifications. All power blocks (except model RPBTLM) require the model RWB4 wiring base.

### Power Block Modules for RSBFF Series Sensor Heads

(see data sheet P/N 03418)

<b>RPBT</b>	10-30V dc; one sinking and one sourcing solid-state output
<b>RPBTLM</b>	10-30V dc low-profile power block (RPBTLM does not require model RWB4 wiring base)
<b>RPBA</b>	105-130V ac (50/60Hz); SPST solid-state output
<b>RPBB</b>	210-250V ac (50/60Hz); SPST solid-state output
<b>RPBU</b>	12-250V ac or 12-30V dc; SPST solid-state output (ac or dc)
<b>RPBR</b>	12-250V ac (50/60Hz) or 12-30V dc; SPST E/M relay output
<b>RPBR2</b>	12-250V ac (50/60Hz) or 12-30V dc; SPDT E/M relay output

**Wiring Base** (see data sheet P/N 03418)

<b>RWB4</b>	4-terminal wiring base required for all power block models (except RPBTLM)
-------------	--

## Excess Gain Curve

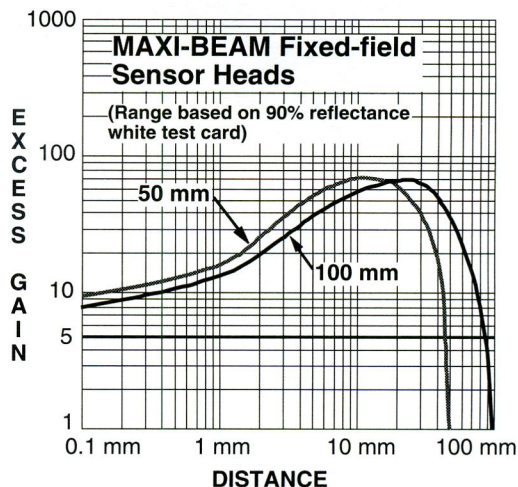

The excess gain curve above shows excess gain vs. sensing distance for MAXI-BEAM® fixed-field sensors with 50- and 100-millimeter cutoffs. Maximum excess gain for the 50-millimeter models occurs at a lens-to-object distance of about 15 millimeters. Maximum excess gain for the 100-millimeter models occurs at a lens-to-object distance of about 25 millimeters. Sensing at or near these distances will make maximum use of each sensor's available sensing power.

Background surfaces and objects must *always* be placed beyond cutoff distance, if it desired that they be ignored.

This excess gain curve was generated using a white test card of 90% reflectance. Objects with reflectivity of less than 90% reflect less light back to the sensor, and require proportionately more excess gain to be sensed with the same reliability as more reflective objects. When sensing an object of very low reflectivity, it may be important to sense it at or near the distance of maximum excess gain.

The effects of object reflectivity on cutoff distance, though small, may be important for some applications. Sensing of objects of less than 90% reflectivity causes the cutoff distances to be "pulled" very slightly closer to the sensor. For example, an excess gain of 1 for an object that reflects 1/5 as much light as the 90% white card is represented by the heavy horizontal graph line at excess gain = 5. An object of this reflectivity results in far limit cutoffs of approximately 47 and 90 millimeters (for 50- and 100-mm cutoff units, respectively).

Objects with reflectivity greater than 90% return more light to the sensor. For this reason, highly reflective backgrounds or background objects such as mirrors, polished metal, and other sources of specular reflections require special consideration. If it is necessary to use a highly reflective background, it should be placed as far beyond the cutoff distance as possible and angled to direct reflected light away from the sensor (see Figures 3 and 4 and the discussion on page 3).

## Setup Tips: MAXI-BEAM Fixed-field Sensors

### General

For highest sensitivity, the sensor-to-object distance should be such that the object will be sensed at or near the point of maximum excess gain (see excess gain curve and discussion, page 2). The background *must* be placed beyond the cutoff distance. Following these two guidelines makes it possible to detect objects of low reflectivity, even against close-in reflective backgrounds.

In the drawings and discussion on this page, the letters E, R1, and R2 identify how the sensor's three optical elements (Emitter "E", Near Detector "R1", and Far Detector "R2") line up across the face of the sensor. In Figures 3, 4, and 5, these elements line up parallel to the surface of the page. In Figure 6, they line up perpendicular to the surface of the page. Note how the position of the tabs on the front of the sensor helps differentiate the two positionings and defines the *sensing axis* of the sensor (Figure 2, below). The sensing axis becomes important in the type of situations illustrated in Figures 5 and 6, discussed below.

### Background reflectivity and placement

Avoid mirror-like backgrounds that produce specular reflections. False sensor response will occur if a background surface reflects the sensor's light more strongly to the *near detector* (R1) than to the far detector (R2). The result is a false "on" condition (Figure 3). Use of a diffusely-reflective (*matte*) background will cure this problem. Other possible solutions are to either angle the sensor or angle the background (in any plane) so that the background does not reflect back to the sensor (see Figure 4).

An object beyond the cutoff distance, either moving or stationary (and when positioned as shown in Figure 5), can cause unwanted triggering of the sensor because it reflects more light to the near detector than to the far detector. The problem can be remedied by rotating the sensor 90° (Figure 6) to place the sensing axis parallel to the surface of the page. The object now reflects the R1 and R2 fields equally, resulting in no false triggering. A better solution, if possible, may be to reposition the object or the sensor.

Unwanted triggering of the sensor from an object beyond cutoff can also be caused by attempting to sense a small object that is moving perpendicular to the sensor face, or by an object moving through the off-center position shown in Figure 5. Making the object larger, centering the sensor relative to the object, or rotating the sensor to place the sensing axis perpendicular to the longer dimension of the object (Figure 6) will solve the problem.

**Figure 2. The sensing axis runs at right angles to a line connecting the sensing elements E, R1, and R2.**

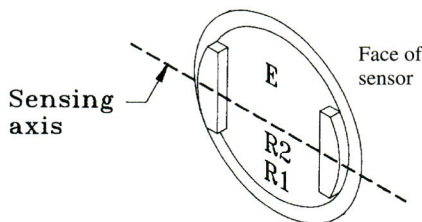

*As a general rule, the most reliable sensing of an object approaching from the side occurs when the line of approach is parallel to the sensing axis.*

**Figure 3. Reflective background - problem**

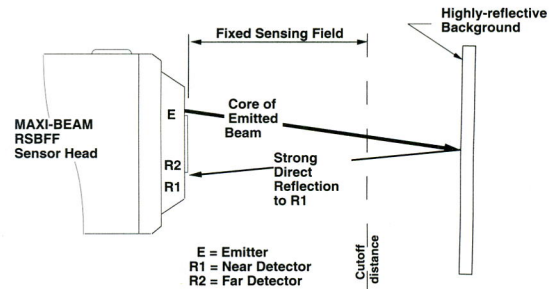

**Figure 4. Reflective background - solution**

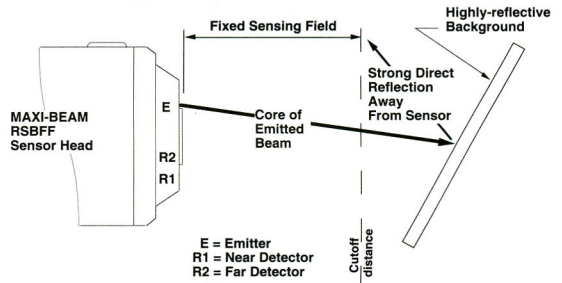

**Figure 5. Object beyond cutoff - problem**

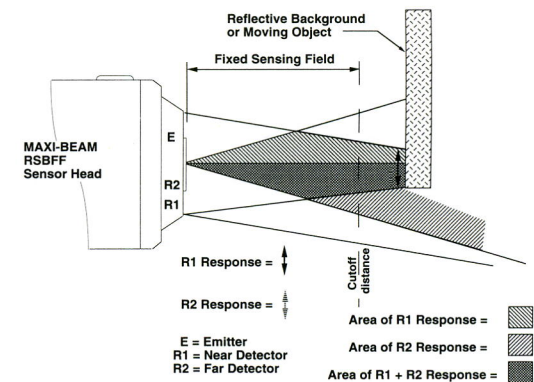

**Figure 6. Object beyond cutoff - solution**

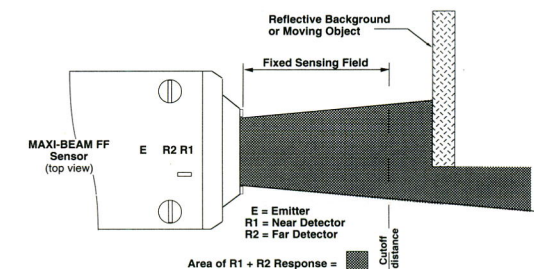

## Dimensions, MAXI-BEAM® Fixed-field Sensors

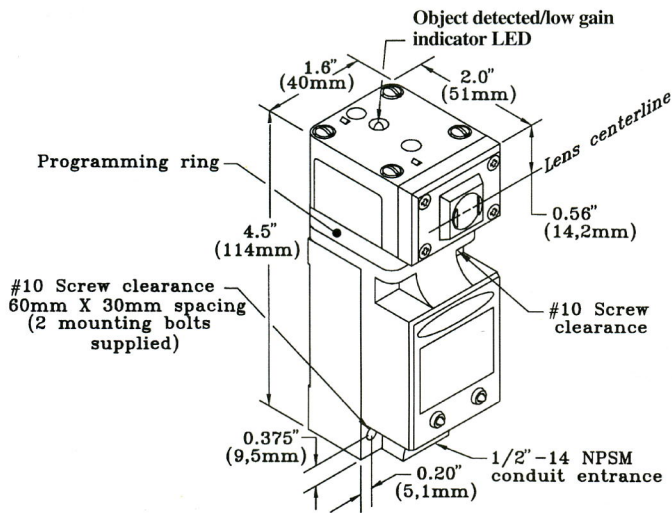

## MAXI-BEAM® Sensors without Logic Modules

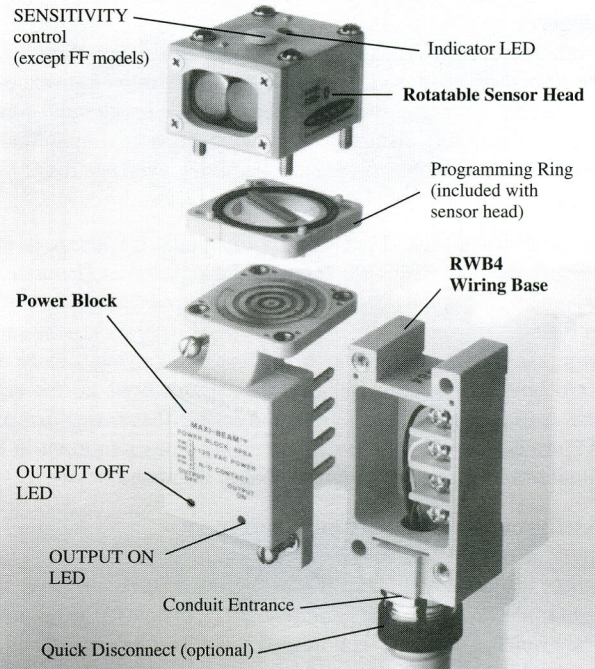

## Light/dark Operate Programming

Light-/dark-operate selection is done at the programming ring. In light-operate mode, the sensor's normally open output will conduct when the sensor "sees" light. In dark-operate mode, the normally open output will conduct when the sensor "sees" dark. First, loosen the four bolts that hold the sensor head to the power block. Remove and separate the sensor head and programming ring. Rejoin the programming ring to the sensor head so that one of the four programming notches on the programming ring lines up with the "10ms" indication beneath the desired operating mode, either "DARK OPERATE" or "LIGHT OPERATE" (as shown in photo), on the sensor head label. The sensor head with programming ring is then reattached to the power block to "look" in any one of the four 90-degree directions around the sensor's vertical axis.

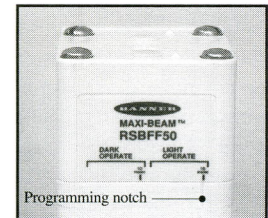

## Other MAXI-BEAM® Sensor Head Modules

Other MAXI-BEAM® Sensor Head Modules, representing all sensing modes (including glass and plastic fiber optic), are available.

They are listed, along with their sensing ranges, in the table at the right. For a full description of these sensor heads, see Banner product data sheet P/N 03416.

## Sensor Head Modules (described in data sheet P/N 03416)

RSBE & RSBR	opposed mode	range to 300'
RSBESR & RSBRSR	opposed mode (short range; narrow beam)	range to 15'
RSBLV	retroreflective mode	range to 30'
RSBLVAG	retroreflective mode (anti-glare filter)	range to 15'
RSBD	long range diffuse proximity mode	range to 5'
RSBDSR	short-range diffuse proximity mode	range to 30"
RSBCV	visible red convergent mode, focus at:	1.5"
RSBC	infrared convergent mode, focus at:	1.5"
RSBF	infrared fiber optic; for glass fibers	
RSBFV	visible red fiber optic; for glass fibers	
RSBEF & RSBRF	infrared fiber optic opposed mode; for glass fibers	
RSBFP	visible red fiber optic; for plastic fibers	



**WARNING** This photoelectric presence sensor does NOT include the self-checking redundant circuitry necessary to allow its use in personnel safety applications. A sensor failure or malfunction can result in *either* an energized or a de-energized sensor output condition.

Never use this product as a sensing device for personnel protection. Its use as a safety device may create an unsafe condition which could lead to serious injury or death.

Only MACHINE-GUARD and PERIMETER-GUARD Systems, and other systems so designated, are designed to meet OSHA and ANSI machine safety standards for point-of-operation guarding devices. No other Banner sensors or controls are designed to meet these standards, and they must NOT be used as sensing devices for personnel protection.

**WARRANTY:** Banner Engineering Corporation warrants its products to be free from defects for one year. Banner Engineering Corporation will repair or replace, free of charge, any product of its manufacture found to be defective at the time it is returned to the factory during the warranty period. This warranty does not cover damage or liability for the improper application of Banner products. This warranty is in lieu of any other warranty either expressed or implied.