

MAXI-BEAM[®]

Power Blocks, RWB4 Wiring Base



Banner MAXI-BEAM[®] sensors are highly versatile, self-contained, modularized photoelectric sensing controls that are ideally suited to industrial environments. The basic MAXI-BEAM is an ON/OFF switch consisting of three modules (*sensor head, power block, and wiring base*) and a unique, patented, rotatable "programming ring" that enables you to program your choice of "light" or "dark" operate mode, sensing range, and response time.

MAXI-BEAM sensor heads have an easily-accessible multi-turn SENSITIVITY control for precise adjustment of system gain. Interchangeable sensor heads are rotatable in 90-degree increments and are available in retroreflective, diffuse, opposed, convergent, and fiberoptic sensing modes. Each sensor head also includes Banner's exclusive AID[™] circuit (Alignment Indicating Device, US patent no. 4356393), which features an LED alignment indicator that lights whenever the sensor "sees" its own modulated light source, and pulses at a rate proportional to the strength of the received light signal.

A wide selection of MAXI-BEAM power block modules is available to interface the sensor head to the circuit to be controlled. The plug-in design of the wiring base enables easy exchange of the entire sensing electronics without disturbing the field wiring. *Power block and wiring base are separate items and each must be purchased separately.*

Optional customer-installable logic modules easily convert the basic ON/OFF MAXI-BEAM into either a one-shot or delay logic function control, with several programmable timing ranges for each function.

MAXI-BEAM sensors are ruggedly constructed of molded VALOX[®] to NEMA standards 1, 3, 4, 12, and 13, and have interchangeable molded acrylic lenses. Modules simply snap and bolt together, with no interwiring necessary. Module interfaces are o-ring and quad-ring sealed for the ultimate in dust, dirt, and moisture resistance.

To order a MAXI-BEAM, follow these steps:

- 1) Select a sensor head module,
- 2) Select a power block module,
- 3) Select a wiring base (must be purchased separately from power block),
- 4) Select a logic module if needed,
- 5) Select accessories as needed (see Banner product catalog).

Sensor Head Modules (described in data sheet P/N 03416)

RSBE & RSBR	opposed mode	range to 300'
RSBESR & RSBRSR	opposed mode (short range; narrow beam)	range to 15'
RSBLV	retroreflective mode	range to 30'
RSBLVAG	retroreflective mode (anti-glare filter)	range to 15'
RSBD	long range diffuse proximity mode	range to 5'
RSBDSR	short-range diffuse proximity mode	range to 30"
RSBCV	visible red convergent mode, focus at:	1.5"
RSBC	infrared convergent mode, focus at:	1.5"
RSBF	infrared fiber optic; for glass fibers	
RSBFV	visible red fiber optic; for glass fibers	
RSBEF & RSBRF	infrared fiber optic opposed mode; for glass fibers	
RSBFP	visible red fiber optic; for plastic fibers	

Power Block Modules (described in this data sheet, P/N 03418)

RPBT	10-30V dc; one sinking and one sourcing solid-state output
RPBT-1	10-30V dc; for use with RSBE, ESR, EF emitters (no output circuit)
RPBTLM	10-30V dc low-profile power block (requires no RWB4 wiring base)
RPBA	105-130V ac (50/60Hz); SPST solid-state output
RPBA-1	105-130V ac (50/60Hz); for use with emitter (no output circuit)
R2PBA	2-wire operation; 105-130V ac (50/60Hz); SPST solid-state output
RPBB	210-250V ac (50/60Hz); SPST solid-state output
RPBB-1	210-250V ac (50/60Hz); use with emitter (no output circuit)
R2PBB	2-wire operation; 210-250V ac (50/60Hz); SPST solid-state output
RPBU	12-250V ac or 12-30V dc; SPST solid-state output (ac or dc)
RPBR	12-250V ac (50/60Hz) or 12-30V dc; SPST E/M relay output
RPBR2	12-250V ac (50/60Hz) or 12-30V dc; SPDT E/M relay output

Wiring Base (described in this data sheet, P/N 03418)

RWB4	4-terminal wiring base for all models (except RPBTLM)
------	---

Logic Modules (described in data sheet P/N 03417)

RLM5	ON/OFF delay (both functions adjustable up to 15 seconds)
RLM8	DELAYED ONE-SHOT (delay and pulse adjustable up to 15 seconds)

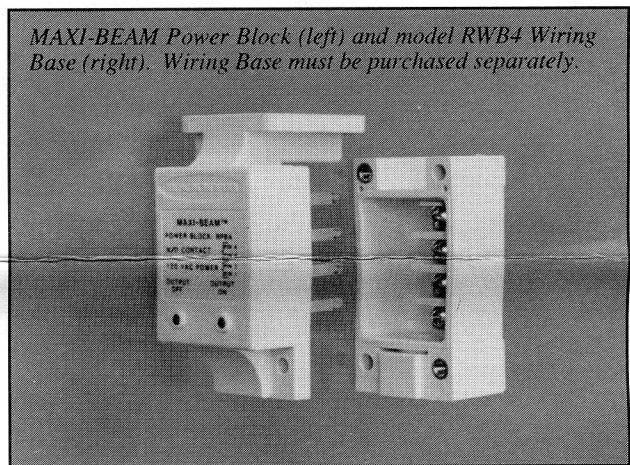

General Specifications

Construction: Reinforced molded VALOX[®] housing. Electronic components fully epoxy encapsulated. O-ring seal between components: NEMA 1, 3, 4, 12, and 13.

Operating Temperature: -40 to +70°C (-40 to +158°F), except models RPBR and RPBR2 (whose range is -40 to +50°C, or -40 to +122°F).

False Pulse Suppression on Power-up: All models.

VALOX[®] is a registered trademark of General Electric Co.

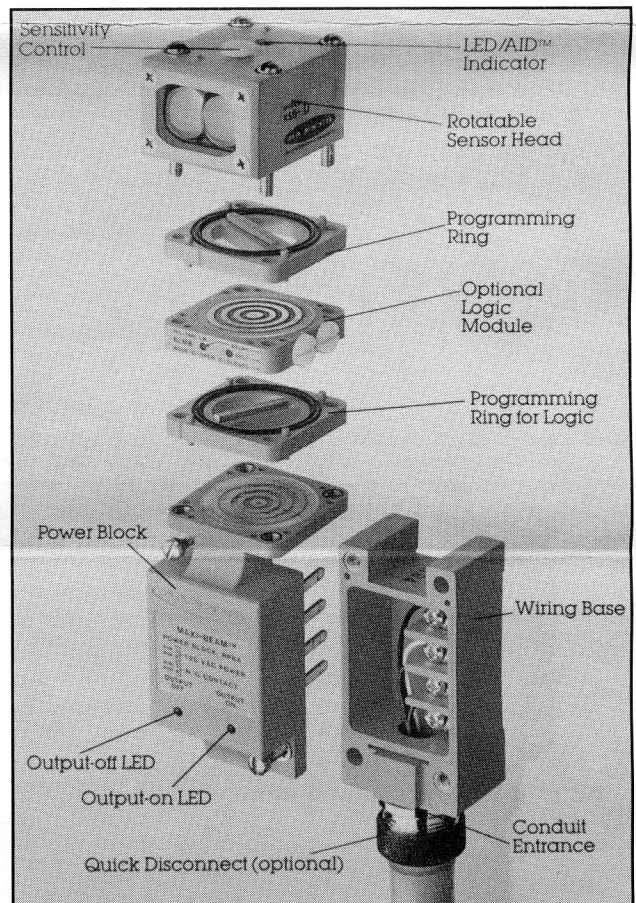

Models RPBT, RPBT-1

10 to 30V dc

UL listed

SP certified

INPUT: 10-30V dc, 20mA exclusive of load; 10% max. ripple.
 OUTPUT: Bi-polar; one open collector NPN (sinking) and one PNP (sourcing) open collector transistor, 250mA continuous, short circuit and reverse-polarity protected (both outputs). *On-state voltage drop for PNP output is less than 1*

volt at 10 mA and less than 2 volts at 250 mA; for NPN output less than 200 millivolts at 10 mA and less than 1 volt at 250 mA. *Off-state leakage current is less than 10 microamps.*

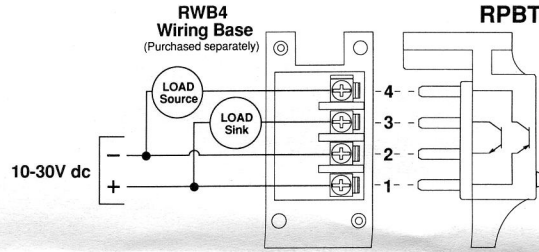
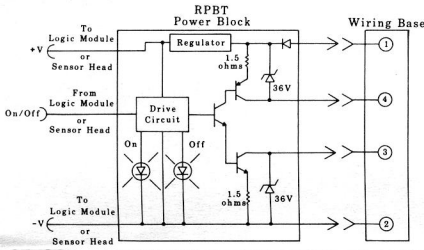

NOTE: model RPBT-1 is used to power the model RSBE, RSBSER, or RSBEF emitter sensor head. RPBT-1 has an input range of 10-30V dc, and no switching elements.

Models RPBA, RPBA-1

120V ac

UL listed

SP certified

INPUT: 105-130V ac (50/60Hz); 2 watts, exclusive of load.
 OUTPUT: SPST solid state switch for ac, 3/4 amp. maximum (derated to 1/2 amp at 70 degrees C). *Maximum inrush is 10 amps for 1 second or 30 amps for*

one ac cycle (non-repeating). *On state voltage drop of less than 2.5V ac at full load. Off state leakage current is less than 100 microamps.*

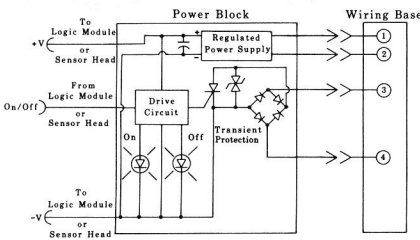

WARNING: Connection of voltage directly across pins 3 and 4, without a load present, will destroy the switching element.

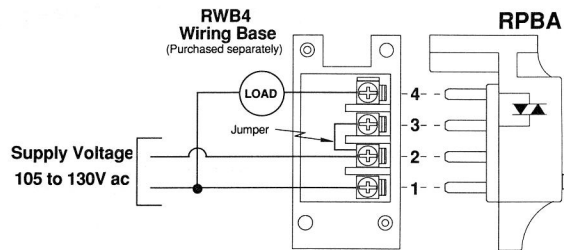

NOTE: ac loads require up to 8.3 milliseconds to turn "off" in addition to the response time of the sensor head and delay logic (if any).

NOTE: model RPBA-1 is used to power the model RSBE, RSBSER, or RSBEF emitter sensor head. RPBA-1 has an input range of 105-130V ac, and no switching element.

Models RPBB, RPBB-1

220/240V ac

UL listed

SP certified

INPUT: 210-250V ac (50/60Hz); 2 watts, exclusive of load.
 OUTPUT: SPST solid state switch for ac, 3/4 amp. maximum (derated to 1/2 amp at 70 degrees C). *Maximum inrush is 10 amps for 1 second or 30 amps for*

one ac cycle (non-repeating). *On state voltage drop of less than 2.5V ac at full load. Off state leakage current is less than 100 microamps.*

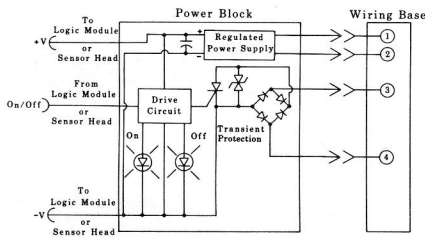

WARNING: Connection of voltage directly across pins 3 and 4, without a load present, will destroy the switching element.

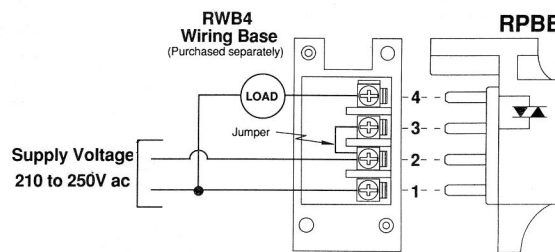

NOTE: ac loads require up to 8.3 milliseconds to turn "off" in addition to the response time of the sensor head and delay logic (if any).

NOTE: model RPBB-1 is used to power the model RSBE, RSBSER, or RSBEF emitter sensor head. RPBB-1 has an input range of 210-260V ac, and no switching element.

Models R2PBA & R2PBB

2-wire ac operation

UL listed

SP certified

INPUT: 105-130V ac (50/60Hz) for model R2PBA; 210-250V ac (50/60Hz) for model R2PBB. 2 watts exclusive of load.
 OUTPUT: SPST solid-state switch for ac, 3/4 amp maximum (derated to 1/2 amp at 70 degrees C). *Maximum inrush is 10 amps for 1 second (non-repeat-*

ing). On-state voltage drop is 5.2V rms at a 1/2 amp load; 14V rms at a load of 10 milliamps. Off-state leakage current is less than 1.7 milliamps (resistive or inductive load).

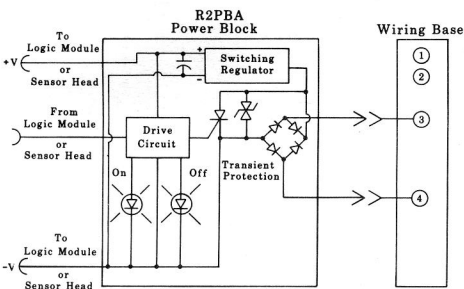

WARNING: all components of a MAXI-BEAM 2-wire assembly will be destroyed if the load becomes a short circuit.

NOTE: use of a 2-wire power block requires programming of the sensor head to the "2W" (2-wire) operating mode.

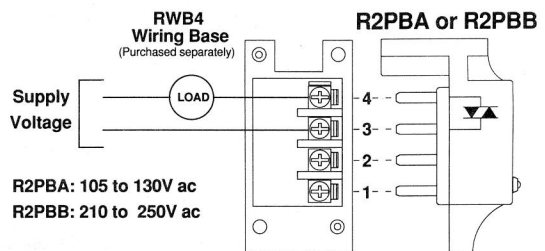

R2PBA: 105 to 130V ac
 R2PBB: 210 to 250V ac

Model RPBR

SPST electromechanical relay output

INPUT: 12-250V ac (50/60Hz) or 12-30V dc, 40mA exclusive of load at 30V dc.
 OUTPUT: SPST electromechanical relay; 250V ac max, 30V dc max, 5 amps max. *Peak switching voltage is 750V ac (install MOV across contact if*

UL listed

CS certified

switching inductive load). *Mechanical life of relay is 10,000,000 operations. Contact response time is 20 milliseconds, open and close.*

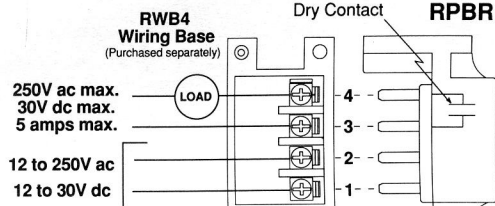
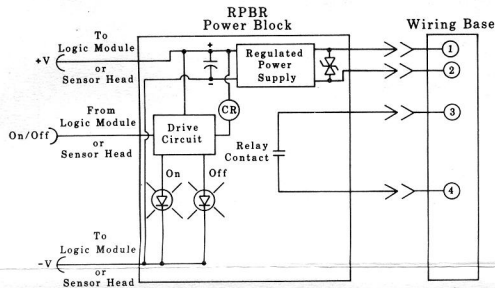

Model RPBR2

SPDT electromechanical relay output

INPUT: 12-250V ac (50/60Hz) or 12-30V dc, 40mA exclusive of load at 30V dc.
 OUTPUT: SPDT electromechanical relay; 250V ac max, 30V dc max, 5 amps max. *Peak switching voltage is 750V ac (install MOV across contact if*

switching inductive load). *Mechanical life of relay is 10,000,000 operations. Contact response time is 20 milliseconds, open and close.*

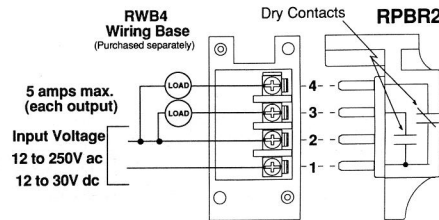
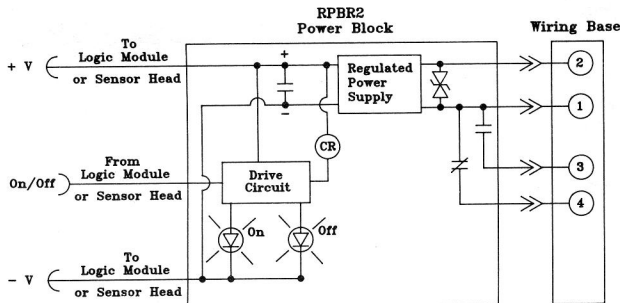

Model RPBU

Universal power input and output

INPUT: 12-250V ac (50/60Hz) or 12-30V dc, 40mA exclusive of load at 30V dc.
 OUTPUT: Optically-isolated SPST solid-state relay; 240V ac or dc max., 100mA max. *On-state voltage drop is 2 volts max. at 100mA (full rated load). DC hookup is without regard to polarity.*

Dimension Drawing, MAXI-BEAM Sensor

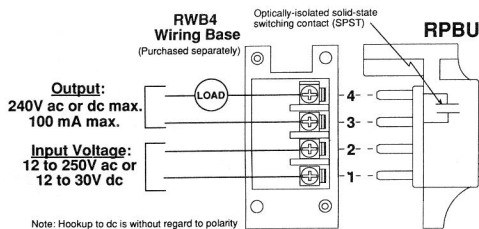

WARNING: Connection of voltage directly across pins 3 and 4, without a load present, will destroy the switching element.

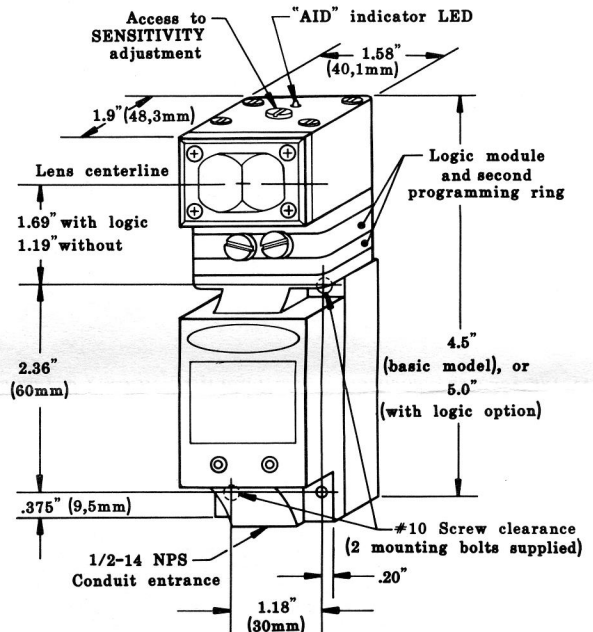
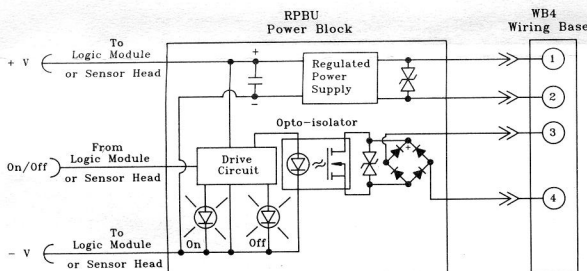

Model RPBTLM Low Profile Power Block

Model RPBTLM is a miniature dc power block for MAXI-BEAM sensors. It may be used with *any* of the MAXI-BEAM sensor head models. It also allows timing logic modules to be added if needed.

The RPBTLM is supplied with stainless steel hardware used for assembly of the MAXI-BEAM components. Components simply bolt together, with no interwiring necessary. The screws supplied are extra-long, and serve as a means to mount the complete MAXI-BEAM sensor assembly to an object or surface.

The RPBTLM may be attached to its sensor head at any of four 90-degree increments to allow the best cable exit direction (front, rear, or either side). A logic module, if used, can be independently rotated (in the same manner) for easiest access to the timing adjustments.

Outputs are in the bi-polar configuration: one current-sinking (NPN) and one current-sourcing (PNP). This design permits direct interfacing of the MAXI-BEAM sensor to almost any type of dc logic input. Either output may be used alone, or both may be used simultaneously. The outputs may be configured for either normally open or normally closed operation via the sensor head (or logic module) programming ring.

Both outputs are rated for 150 milliamps, sufficient capacity for direct switching of most electromechanical dc loads like relays and solenoids. The RPBTLM includes an LED indicator to show the output status.

The RPBTLM is completely solid-state and epoxy-encapsulated. It is gasketed to other MAXI-BEAM components by a quad-ring seal. Refer to the data sheets for MAXI-BEAM sensor heads (P/N 03416) and MAXI-BEAM logic modules (P/N 03417) or to the Banner product catalog for complete information on the assembly and programming of MAXI-BEAM sensor components.

Specifications

Input: 10 to 30V dc, 10% maximum ripple.

Output Configuration: Bi-polar. One current sinking (NPN) and one current sourcing (PNP) open-collector transistor switch.

Output Rating: 150mA maximum each output at 25°C (derated to 100mA at 70°C). Derate 1mA per °C.

Output Protection: Protected against false pulse on power-up, inductive load transients, power supply polarity reversal, and continuous overload or short-circuit of outputs.

On-state Voltage Drop:

NPN output less than 200 millivolts at 10mA and less than one volt at 150mA.
PNP output less than 1 volt at 10mA and less than 2 volts at 150mA.

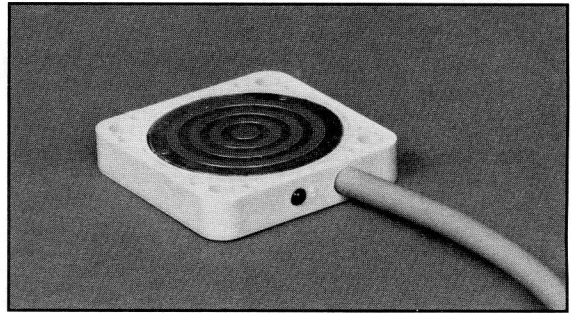

Dimension Drawing

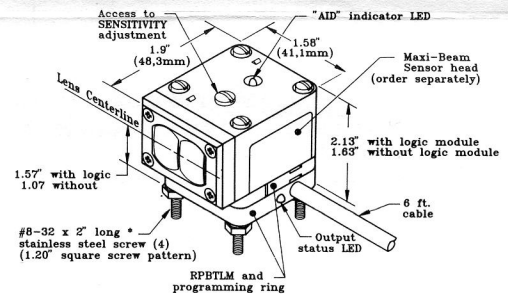

*NOTE: #8-32 x 2 1/2" long screws are also supplied with RPBTLM for assembly when a logic module is added.

Functional Schematic

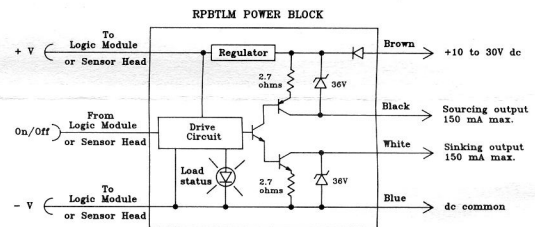

Off-state Leakage Current:

Less than 1 microamp.

Hookup Information, model RPBTLM low-profile power block

The RPBTLM powers the sensor head from a 10 to 30VDC supply. It contains output circuitry to allow an interface of the signal from the sensor head to a load or to a logic input.

The RPBTLM offers bi-polar outputs: one current sinking (NPN) and one current sourcing (PNP). Either output may be used, or both outputs may be used at the same time. The switching capacity of each output is 150 mA max.

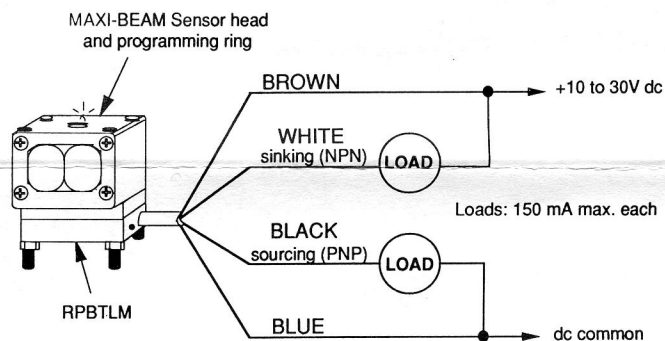

WARRANTY: Banner Engineering Corporation warrants its products to be free from defects for one year. Banner Engineering Corporation will repair or replace, without charge, any product of its manufacture found to be defective at the time it is returned to the factory during the warranty period.

This warranty does not cover damage or liability for the improper use of Banner products. This warranty is in lieu of any other warranty either expressed or implied.