

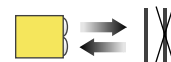

Features

- Push-button adjustable-field background suppression sensor detects objects within a defined sensing field, while ignoring objects located beyond the sensing field cutoff
- Easy cutoff point push-button SET options: Background Suppression SET, Object Detection SET and Dynamic SET, plus manual adjustments.
- Easy push-button N.O./N.C. and output OFF-delay setup
- Powerful, highly collimated visible red sensing beam
- Tough ABS housing is rated IEC IP67; NEMA 6
- Easy-to-read operating status indicators, with 8-segment bargraph display
- Bipolar discrete outputs, PNP and NPN
- Selectable 30 millisecond OFF-delay
- Models available with 2 m or 9 m (6.5' or 30') cable or integral quick-disconnect
- Compact housing, mounting versatility – via popular 30 mm threaded barrel or side-mount



Visible Red, 660 nm

Models

Model	Cutoff Point	Cable*	Supply Voltage	Output Type
QS30AF	50 to 300 mm (2" to 12")	2 m (6.5') 5-wire Cable	10 to 30V dc	Bipolar NPN/PNP
QS30AFQ		Integral 5-pin Euro-style QD		

*9 m (30') cables are available by adding suffix "W/30" to the model number of any cabled sensor (e.g., **QS30AF W/30**).
A model with a QD connector requires a mating cable (see page 9).



WARNING . . . Not To Be Used for Personnel Protection

Never use this product as a sensing device for personnel protection. Doing so could lead to serious injury or death.

This product does NOT include the self-checking redundant circuitry necessary to allow its use in personnel safety applications. A sensor failure or malfunction can cause either an energized or de-energized sensor output condition. Consult your current Banner Safety Products catalog for safety products which meet OSHA, ANSI and IEC standards for personnel protection.

WORLD-BEAM® QS30AF Adjustable-Field Sensor

Overview

The QS30AF is an easy-to-use triangulation sensor which provides a sophisticated, yet cost-effective solution for demanding applications.

The sensor features two identically configured outputs, one each NPN and PNP.

The sensor's compact housing has a large, easy-to-see bargraph display plus bright LEDs for easy configuration and status monitoring during operation. The sensor can be side-mounted, using its integral mounting holes, or front-mounted, via its 30 mm threaded barrel.

Optical Triangulation

The function of the QS30AF Sensor is based on optical triangulation (see Figure 2). The emitter circuitry and optics create a light source which is directed toward a target. The light source bounces off the target, scattering some of its light through the sensor's receiver lens to its position-sensitive-device (PSD) receiver element. The target's distance from the receiver determines the light's angle to the receiver element; this angle determines where the returned light falls on the PSD receiver element.

The position of the light on the PSD receiver element is processed through digital electronics and analyzed by the microprocessor. The microprocessor will compare the target position to the cutoff limits and then change the outputs as required.

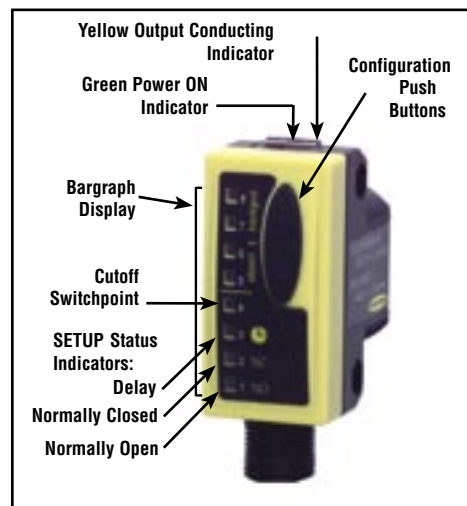

Figure 1. QS30 features

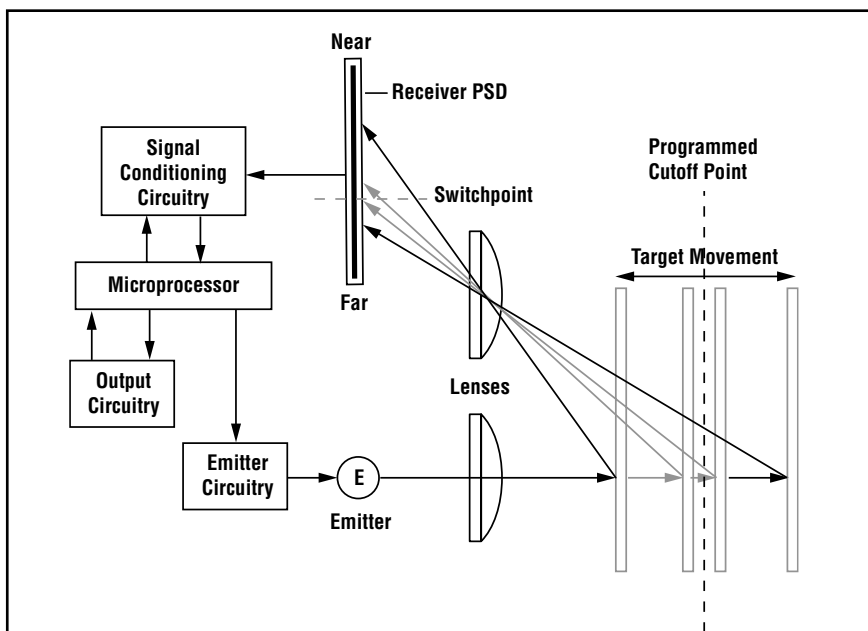

Figure 2. Using optical triangulation to determine sensing distance

WORLD-BEAM® QS30AF Adjustable-Field Sensor

Sensor Configuration

The sensor's cutoff point is set using a simple procedure, via either the push buttons or the remote wire. Three methods are available: Background Suppression SET, Object Detection SET, and Dynamic SET (remote only). After the sensor has been set for the target application, manual adjustments (via the "+" and "-" push buttons) may be used to fine-tune the cutoff point. Sensor output configuration (N.O./N.C.) and the OFF-delay function are also set via the push buttons.

Remote Configuration

The Remote Configuration function may be used to configure the sensor remotely or to disable the push buttons for security. Connect the gray wire of the sensor to ground (0V dc), with a remote switch connected between them. Pulse the remote line according to the diagrams in the configuration procedures. The length of the individual pulses is equal to the value T:

$$0.04 \text{ seconds} \leq T \leq 0.8 \text{ seconds}$$

Background Suppression SET

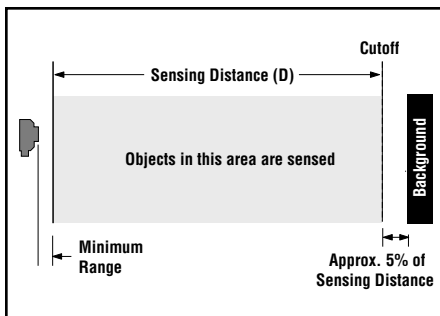
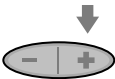

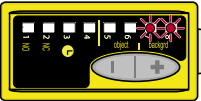
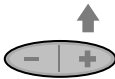

Figure 3. Background Suppression SET

The distance to the background is sampled; the sensor places the cutoff point at approximately 95 percent of the distance to the background. In RUN mode, objects located between the minimum range and the taught cutoff are sensed; anything beyond the cutoff (e.g., other objects or background surfaces) is ignored.

Minimum range varies, depending on the cutoff distance and reflectivity (see Figure 11).

	Push Button	Remote $0.04 \text{ seconds} \leq T \leq 0.8 \text{ seconds}$	Result
Set Background	<ul style="list-style-type: none"> Present background condition. Press and hold Background (+) push button > 2 seconds (until indicators flash). 	<ul style="list-style-type: none"> Present background condition. Single-pulse the remote line. 	<ul style="list-style-type: none"> Indicator segments 7 and 8 alternately flash. 
Return to RUN Mode	<ul style="list-style-type: none"> Sampling continues until the push button is released; then sensor returns automatically to RUN mode. 	<ul style="list-style-type: none"> Sensor returns to RUN mode. 	<ul style="list-style-type: none"> If cutoff is accepted, sensor returns directly to RUN mode. If cutoff is beyond sensor range, Feedback is displayed for 2 seconds (see page 6).*

*Segments 7 and 8 simultaneously flashing: Indiscernible target; sensor defaults to maximum cutoff.

Segments 1 and 2 simultaneously flashing: Background is nearer than minimum cutoff; sensor defaults to minimum cutoff.

WORLD-BEAM® QS30AF Adjustable-Field Sensor

Object Detection SET

The distance to the target is sampled; the sensor places the cutoff point at approximately 105 percent of the distance to the target. In RUN mode, objects located between the minimum range and the cutoff are sensed; anything beyond the cutoff (e.g., other objects or background surfaces) is ignored.

Minimum range varies, depending on the cutoff distance and reflectivity (see Figure 11).

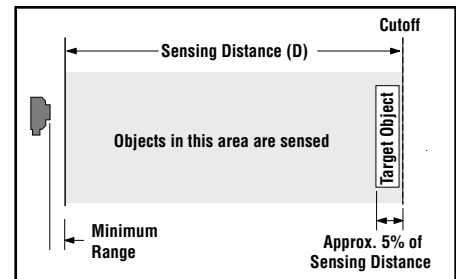
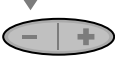
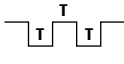
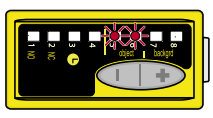



Figure 4. Object Detection SET

	Push Button	Remote $0.04 \text{ seconds} \leq T \leq 0.8 \text{ seconds}$	Result
Sample Target Object	<ul style="list-style-type: none"> Present target object. Press and hold Object (-) push button > 2 seconds (until indicators flash). 	<ul style="list-style-type: none"> Present target object. Double-pulse the remote line. 	<ul style="list-style-type: none"> Indicator segments 5 and 6 alternately flash. 
Return to RUN Mode	<ul style="list-style-type: none"> Sampling continues until the push button is released; then sensor returns automatically to RUN mode. 	<ul style="list-style-type: none"> Sensor returns automatically to RUN mode. 	<ul style="list-style-type: none"> Cutoff accepted: Sensor returns directly to RUN mode. Cutoff beyond sensor range: Feedback is displayed for 2 seconds (see page 6).*

***Segments 7 and 8 simultaneously flashing:** Indiscernible target; sensor defaults to maximum cutoff.

Segments 1 and 2 simultaneously flashing: Cutoff set is nearer than minimum cutoff; sensor defaults to minimum cutoff.

Manual Adjust

- Click the push buttons (“+” or “-”) to adjust the cutoff by approximately 2 percent.
 - To suppress background more, click Background button.
 - To increase object detection, click Object button.
- The display will momentarily blink to acknowledge cutoff movement.
- If the cutoff is at an extreme, the “far” (7th and 8th) or “near” (1st and 2nd) bargraph segments will flash simultaneously to indicate that the cutoff did not adjust.

WORLD-BEAM® QS30AF Adjustable-Field Sensor

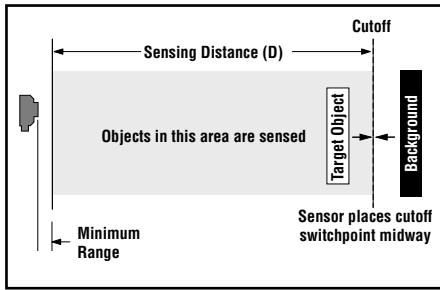

Figure 5. Dynamic SET

Dynamic SET

The sensor samples the distances to both the target objects and the background surface; the sensor places the cutoff point midway between the object and the background. In RUN mode, objects located between the minimum range and the cutoff are sensed; anything beyond the cutoff (e.g., other objects or background surfaces) is ignored.

Minimum range varies, depending on the cutoff distance and reflectivity (see Figure 11).

	Push Button	Remote $0.04 \text{ seconds} \leq T \leq 0.8 \text{ seconds}$	Result
Sample Target Present and Absent Conditions	Not available via push button	<ul style="list-style-type: none"> Hold remote line low > 2 seconds (until indicators flash); continue to hold low while presenting at least 1 full application cycle 	<ul style="list-style-type: none"> Indicator segments 1 and 8 alternately flash.
Return to RUN Mode		<ul style="list-style-type: none"> Sampling continues until the remote line is released; then sensor returns automatically to RUN mode. 	<ul style="list-style-type: none"> Cutoff accepted: Sensor returns directly to RUN mode. Cutoff beyond sensor range: Feedback is displayed for 2 seconds (see page 6).*

*Segments 7 and 8 simultaneously flashing: Indiscernible target; sensor defaults to maximum cutoff.

Segments 1 and 2 simultaneously flashing: Cutoff set is nearer than minimum cutoff; sensor defaults to minimum cutoff.

WORLD-BEAM® QS30AF Adjustable-Field Sensor

Bar Graph Indicator Functions

RUN Mode

- Lighted bargraph segment represents relative distance from the cutoff point.
- **All segments OFF:** No object is detected within the visible range.

SET Mode

- **Segments 7 and 8 alternately flashing:** Background Suppression SET is active
- **Segments 5 and 6 alternately flashing:** Object Detection SET is active
- **Segments 1 and 8 alternately flashing:** Dynamic SET is active

SET Mode Feedback

If the cutoff point is accepted, the sensor returns immediately to RUN mode. If the taught cutoff point is beyond sensor range (closer than 50 mm or farther than 300 mm), the following are indicated for 2 seconds. (The sensor defaults to either maximum or minimum cutoff, then returns to RUN mode.)

- **Segments 7 and 8 simultaneously flashing:** Indiscernible target; either no target or a highly reflective target (see page 7). Sensor defaults to maximum cutoff.
- **Segments 1 and 2 simultaneously flashing:** Target is nearer than minimum cutoff. Sensor defaults to minimum cutoff.

SETUP Mode

SETUP mode (accessible via push buttons only) is used to change sensor output response for:

- Normally Closed or Normally Open operation
- 30-millisecond pulse stretcher (OFF-delay), if required

The status LEDs, active only during SETUP mode, indicate the output response configuration when the sensor will be in RUN mode. Four combinations are possible:

- Normally Open, No Delay
- Normally Closed, No Delay
- Normally Open, 30 ms Delay
- Normally Closed, 30 ms Delay

To access SETUP mode and change the output response settings:

- 1) Press and hold BOTH push buttons simultaneously until the green LED indicator turns OFF.
- 2) Click EITHER push button to toggle through the four possible setting combinations.
- 3) Sensor returns to RUN mode after push buttons are inactive for 4 seconds.

NOTE: Outputs are active during SETUP mode.

Push Button Disable

In addition to its configuration function, the remote wire may be used to disable the push buttons for security. Disabling the push buttons prevents accidental or unauthorized adjustment of the sensor settings. Connect the gray wire of the sensor as described on page 3, and four-pulse to either enable or disable the push buttons:

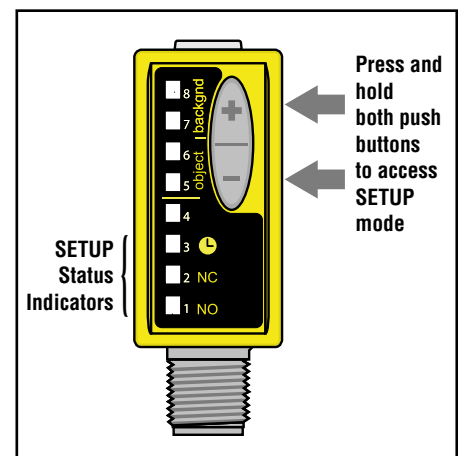
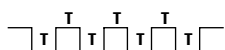

Figure 6. SETUP mode

WORLD-BEAM® QS30AF Adjustable-Field Sensor

Installation Notes

Sensor Orientation

Some targets (those with a stepped plane facing the sensor, a boundary line, or rounded targets) pose specific problems for sensing distances. For such applications, see Figure 7 for suggested mounting orientation.

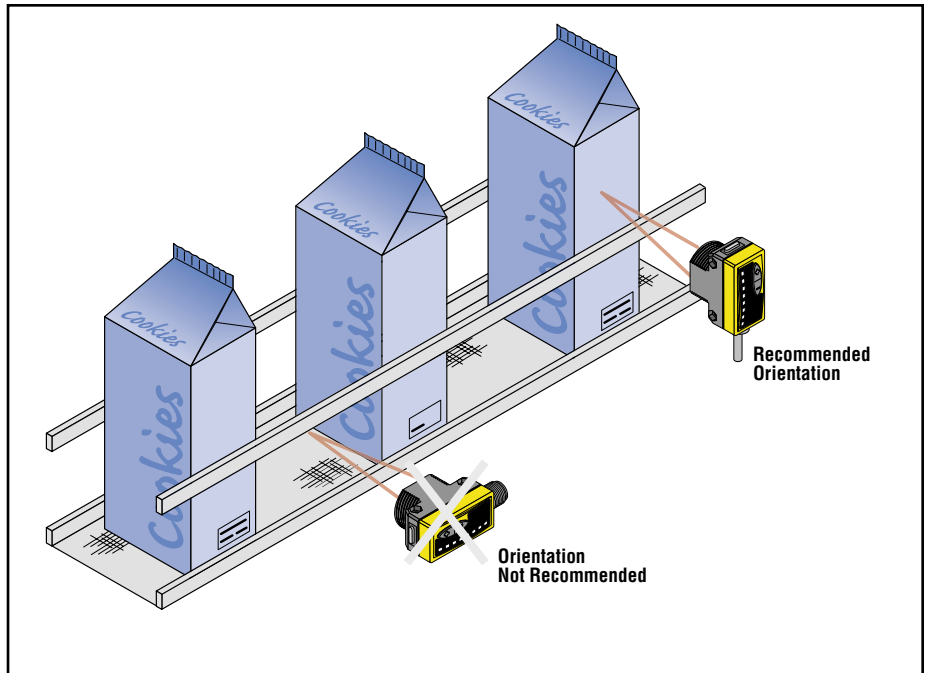

Figure 7. Sensor orientations for typical targets

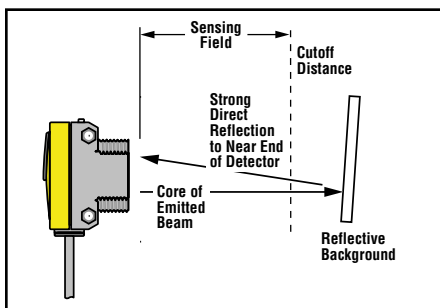

Figure 8. Reflective background – problem

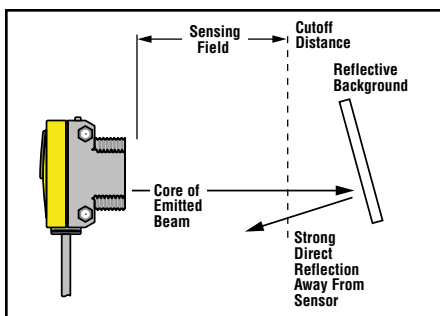

Figure 9. Reflective background – solution

Highly Reflective Backgrounds

Use caution when sensing mirror-like background surfaces that produce specular reflections. False sensor response can occur if a background reflects the sensor's light more strongly to the near end of the detector than to its far end, resulting in a possible false ON condition. Use of a diffusely reflective (matte) background will cure this problem. Other possible solutions are to angle either the sensor or the background (in any plane) so that the background does not reflect back to the sensor (see Figures 8 and 9).

For these applications, the Object Detection SET procedure is recommended.

WORLD-BEAM® QS30AF Adjustable-Field Sensor

Specifications

Sensing Beam	660 nm visible red
Supply Voltage	10 to 30V dc (10% max. ripple) @ 45 mA max current, exclusive of load
Supply Protection Circuitry	Protected against reverse polarity, over voltage, and transient voltages
Delay at Power-Up	250 ms; outputs do not conduct during this time
Output Configuration	Bipolar: 1 current sourcing (PNP) and 1 current sinking (NPN)
Output Ratings	150 mA maximum load (derate ~ 1 mA/°C above 25°C) OFF-state leakage current: < 50 µA at 30V dc ON-state saturation voltage: NPN: < 200 mV @ 10 mA; < 1V @ 150 mA PNP: < 1.25V @ 10 mA; < 2V @ 150 mA
Output Protection	Protected against output short-circuit, continuous overload, transient over-voltages, and false pulse on power up
Output Response Time	1 millisecond
Repeatability	170 microseconds
Adjustments	2 push buttons and remote wire <ul style="list-style-type: none"> • Easy push-button configuration • Manually adjust (+/-) cutoff (push buttons only) • N.O./N.C. and OFF-delay configuration options (push buttons only) • Push-button lockout (from remote wire only)
Indicators	8-segment red bargraph: Distance relative to cutoff point Green LED: Power ON Yellow LED: Output conducting
Construction	ABS plastic housing; acrylic lens cover
Environmental Rating	IP67, NEMA 6
Connections	5-conductor 2 m (6.5') PVC cable, 9 m (30') PVC cable, or 5-pin integral Euro-style quick-disconnect fitting
Operating Conditions	-10° to +55°C (+14° to 122°F), 90% relative humidity @ 55°C (non-condensing)
Vibration and Mechanical Shock	All models meet Mil. Std. 202F requirements. Method 201A (Vibration: 10 to 60 Hz max. double amplitude 0.06", maximum acceleration 10G). Also meets IEC 947-5-2 requirements: 30G, 11 ms duration, half sine wave.
Certifications	

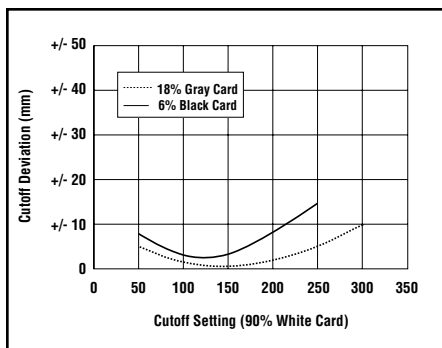

Figure 10. QS30AF cutoff point deviation

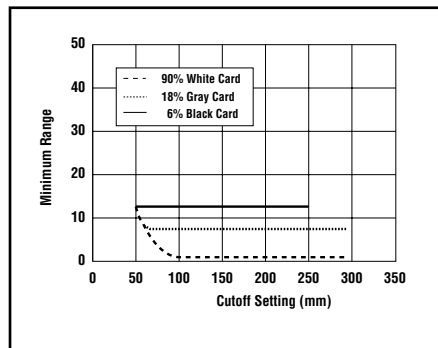

Figure 11. QS30AF minimum range vs. cutoff setting

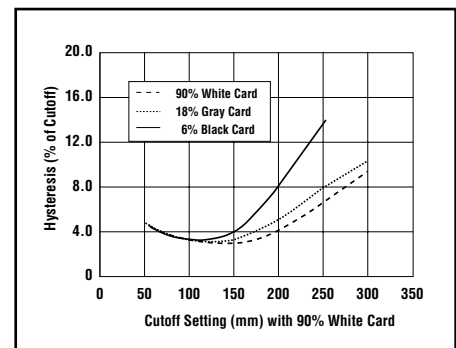
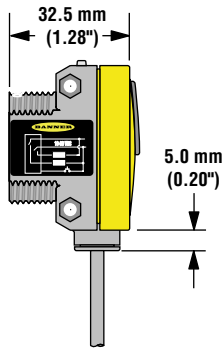

Figure 12. QS30AF hysteresis

WORLD-BEAM® QS30AF Adjustable-Field Sensor

Dimensions

Cabled Models



Hardware Included:
(10) M3 x 0.5 x 28 stainless steel machine screws, nuts and washers

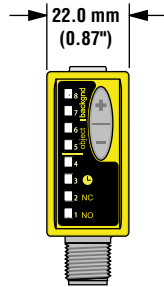

QD Models

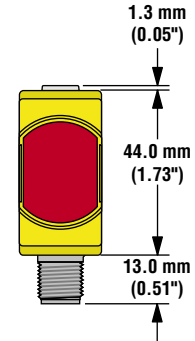
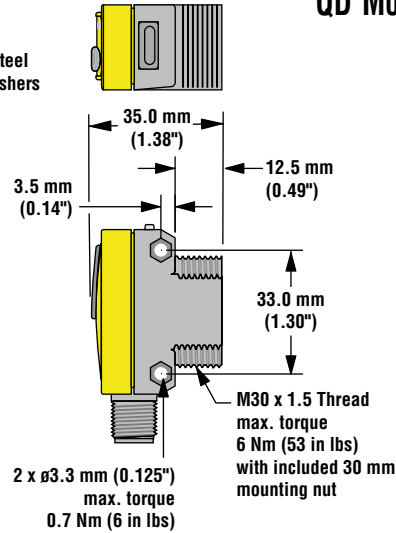

Hookups

Cabled Models

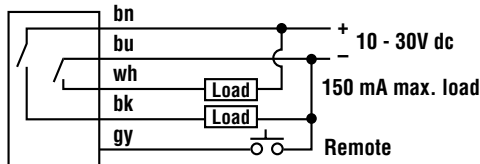

QD Models

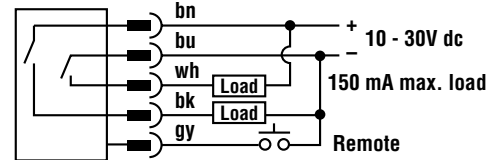

Accessories

Quick-Disconnect Cables

Style	Model	Length	Dimensions	Pin-Out
5-pin Euro-style straight	MQDC1-506 MQDC1-515 MQDC1-530	2 m (6.5') 5 m (15') 9 m (30')		
5-pin Euro-style right-angle	MQDC1-506RA MQDC1-515RA MQDC1-530RA	2 m (6.5') 5 m (15') 9 m (30')		

WORLD-BEAM® QS30AF Adjustable-Field Sensor

Brackets	
<p>SMBQS30L</p> <ul style="list-style-type: none"> • 14-gauge, stainless steel right-angle bracket for cable models • Clearance for M4 (#8) hardware • ± 12° tilt adjustment 	<p>SMBQS30LT</p> <ul style="list-style-type: none"> • 14-gauge stainless steel for QD models with right-angle cables • Tall right-angle mounting bracket • ± 8° tilt adjustment
<p>SMBQS30Y</p> <ul style="list-style-type: none"> • Heavy-duty die-cast bracket • M18 vertical mounting option • ± 8° tilt adjustment with cabled units • Nuts and lockwasher included 	<p>Other Compatible Mounting Brackets:</p> <ul style="list-style-type: none"> • SMB30MM • SMB30SC • SMB30A

WORLD-BEAM® QS30AF Adjustable-Field Sensor

WORLD-BEAM® QS30AF Adjustable-Field Sensor



more sensors, more solutions

WARRANTY: Banner Engineering Corp. warrants its products to be free from defects for one year. Banner Engineering Corp. will repair or replace, free of charge, any product of its manufacture found to be defective at the time it is returned to the factory during the warranty period. This warranty does not cover damage or liability for the improper application of Banner products. This warranty is in lieu of any other warranty either expressed or implied.