

## U-GAGE™ Analog Q45UR Remote Ultrasonic Sensors

*Piezoelectric Analog Proximity Mode Sensors with Push Button or Remote Programming of Sensing Window*

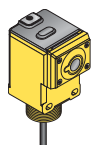

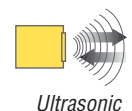

### Analog Q45UR Series Features

- Ultrasonic ranging from 50 to 250 mm (2" to 10")
- Push-button TEACH-mode programming of sensing window limits
- Window limits may be set in two ways: by individually setting the near and far window limits, or by programming a set point to be centered within a 5-mm sensing window.
- Digital filtering for exceptional immunity to random electrical and acoustic "noise"
- Selectable 0 to 10V dc voltage sourcing or 4 to 20mA current sourcing analog outputs
- Selectable output slope: positive or negative with increasing target distance
- Wide operating temperature range of -25° to +70°C; all models include temperature compensation
- Rugged design for use in demanding sensing environments; rated IEC IP67, NEMA 6P (controller), IP65 (sensor)
- Choose models with integral 2 m (6.5') or 9 m (30') cable, or with Mini-style or Euro-style quick disconnect fitting
- Choose from 3 remote sensors: 18 mm threaded-barrel models in either stainless steel or molded PBT polyester, and a molded flat-pak model
- Remote sensors connect to controller via an integral 2 m (6.5') cable
- Input for remote TEACH-mode programming of window limits
- 0.10 mm resolution (0.004")
- Kit includes both controller and sensor; components also sold separately
- Response time is adjustable from 10 to 320 milliseconds



### Q45UR Series Ultrasonic Sensor Models

Kit Models	Kit Includes Controller Model	Controller Cable*	Controller Output	Supply Voltage	Kit Includes Sensor Model	Sensor Range
Q45UR3LIU64CK Q45UR3LIU64CQK Q45UR3LIU64CQ6K	Q45UR3LIU64C Q45UR3LIU64CQ Q45UR3LIU64CQ6	2 m (6.5') 5-Pin Mini QD 5-Pin Euro QD	Selectable 0-10V dc or 4-20mA Sourcing	15-24V dc	 M18C2.0 Stainless Steel Barrel	50 to 250 mm (2" to 10")
Q45UR3LIU64CKQ Q45UR3LIU64CQKQ Q45UR3LIU64CQ6KQ	Q45UR3LIU64C Q45UR3LIU64CQ Q45UR3LIU64CQ6	2 m (6.5') 5-Pin Mini QD 5-Pin Euro QD			 Q13C2.0 Flat-Pak	
Q45UR3LIU64CKS Q45UR3LIU64CQKS Q45UR3LIU64CQ6KS	Q45UR3LIU64C Q45UR3LIU64CQ Q45UR3LIU64CQ6	2 m (6.5') 5-Pin Mini QD 5-Pin Euro QD			 S18C2.0 Molded Barrel	

\*NOTES:

- 9 m (30') cables are available by adding suffix "W/30" to the model number of any cabled sensor (e.g., Q45UR3LIU64CK W/30).
- A model with a QD connector requires a mating cable; see page 9.

# U-GAGE™ Analog Q45UR Remote Ultrasonic Sensors

## Programming the Sensing Window Limits

The Q45UR controller features a single push button for programming the sensing window limits (Figure 1). The window limits may be set in one of two ways: programming two independent window limits, or defining a sensing distance set point, which will be centered automatically within a 5-mm window (specific steps are described on page 5).

**Independent Window Limits:** The target is placed at the desired position to set the first limit, then the second limit is set using the same procedure. In order to set two independent limits, the window must at least 5 mm.

**Sensing Distance Set Point:** The sensor is taught the same set point for both window limits. The set point is automatically centered within a 5-mm (0.2") window.

See page 5 for detailed programming instructions.

## Status Indicators

Status indicator LEDs are visible through the transparent, o-ring sealed Lexan® top cover. Indicator function in the **RUN** mode is, as follows:

- The green LED is ON steadily whenever power is applied to the sensor, and flashes to indicate a current output fault.
- The red LED lights when an echo is received, and flashes at a rate that is proportional to echo strength.
- The yellow LED lights whenever the target is within the operating window limits.

The 5-segment moving dot LED indicator displays the relative position of the target within the programmed sensing window. The #1 LED flashes when the target is closer than the near limit. The #5 LED flashes when the target is beyond the far limit.

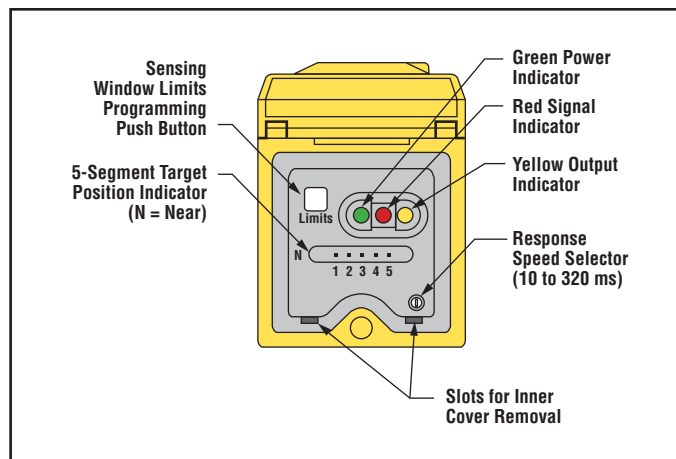

Figure 1. Analog Q45UR controller features

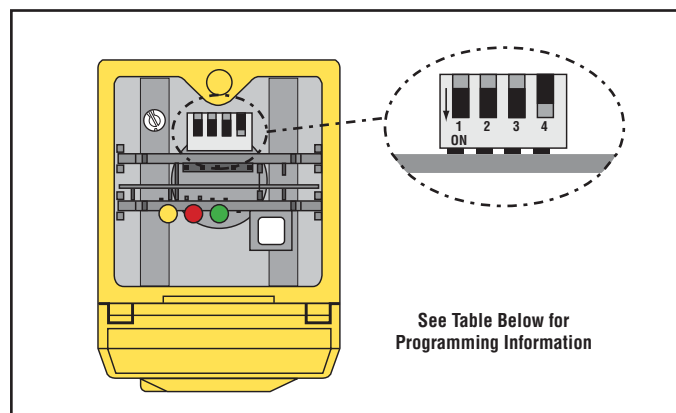

Figure 2. Analog Q45UR controller programming DIP switches (factory default settings)

# U-GAGE™ Analog Q45UR Remote Ultrasonic Sensors

## Output Response Settings

IMPORTANT: Remove power before making any internal adjustments.

Using the two slots shown in Figure 1, a small flat-blade screwdriver may be used to lift up and remove the black inner cover to expose the 4-position DIP switch (Figure 2).

Those switches are used to program the following functions:

Switch	Function	Settings
1	Output Slope	ON = Output value <i>increases</i> with distance OFF* = Output value <i>decreases</i> with distance
2	Output Mode	ON = Current output enabled OFF* = Voltage output enabled
3	Loss of Echo	ON = Min - Max Mode OFF* = Hold Mode
4	Min - Max	ON* = Default to maximum output value OFF = Default to minimum output value

## Explanation of Programmable Output Functions:

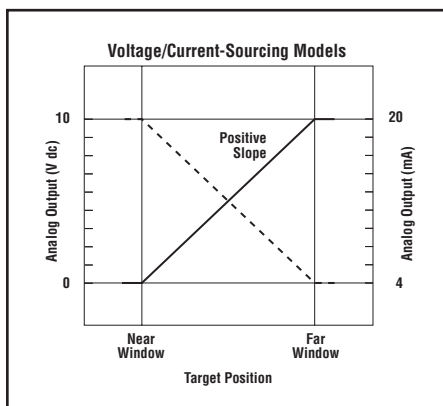

Figure 3. Output as a function of target position

### Switch 1: Output Slope Select

ON = (Direct) Output value (voltage or current) increases with increasing distance of the target from the sensor

OFF\* = (Inverse) Output value decreases with increasing distance of the target from the sensor

### Switch 2: Output Mode Select

ON = The 4 to 20mA current output (white wire) is enabled

OFF\* = The 0 to 10V dc voltage output (black wire) is enabled

This switch configures the D/A driver to use either the current output or the voltage output driver.

### Switch 3: Loss of Echo Mode Select

ON = Min - Max Mode

OFF\* = Hold Mode

This switch determines the output response to the loss of echo. The “Hold Mode” (Switch 3 Off\*) maintains the output at the value which was present at the time of echo loss. The “Min - Max Mode” (Switch 3 On) drives the output to either the minimum value (0V or 4mA or the maximum value (10V or 20mA) when the echo is lost. Minimum or maximum value is selected by Switch 4.

### Switch 4: Min - Max Default

ON\* = Default to maximum output value at loss of echo

OFF = Default to minimum output value at loss of echo

Switch 4 selects the output response to loss of echo when “Min - Max Mode” is selected by Switch 3 (see above).

\* Factory default setting

# U-GAGE™ Analog Q45UR Remote Ultrasonic Sensors

## Response Speed Adjustment

The speed of the output response is set using the single-turn potentiometer (see Figures 1 and 4). There are six values for response speed, which relate directly to the number of sensing cycles over which the output value is averaged (see the Response Speed Settings table, below). The response value is set by aligning the slot of the potentiometer with one of the marked positions. The positions are identified in Figure 4.

Response Speed Settings	
Position	Response Speed
1	10 milliseconds (2 cycles)
2	20 milliseconds (4 cycles)
3	40 milliseconds (8 cycles)
4	80 milliseconds (16 cycles)
5	160 milliseconds (32 cycles)
6	320 milliseconds (64 cycles)

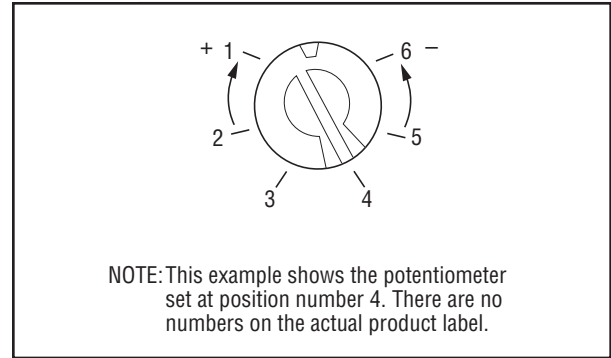
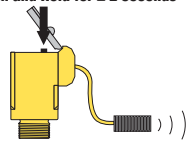
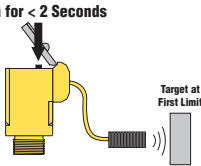
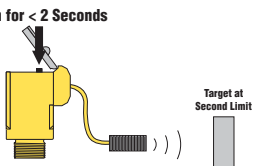

Figure 4. Response adjustment positions

## Window Limit Programming

Either the “Limits” push button (located under the transparent top cover) or the Remote TEACH wire may be used to program the near and the far limits. The near limit may be set as close as 50 mm (2") and the far limit may be set as far as 250 mm (10") from the transducer face. Minimum window width is 5 mm (0.2"). Whenever possible, use the actual target to be sensed when setting the window limits. The following procedure begins with the sensor in RUN mode.

# U-GAGE™ Analog Q45UR Remote Ultrasonic Sensors

Push Button		Indicator Status
<p><b>Step 1</b></p> <p><b>Access Limit Programming Mode</b> Push and hold until green indicator turns OFF (approximately 2 seconds)</p>	<p>Push and Hold for <math>\geq 2</math> Seconds</p> 	<p><b>Green:</b> Goes OFF</p> <p><b>Yellow:</b> ON steady to indicate ready for teaching first limit</p> <p><b>Red:</b> Flashes to indicate strength of echo or is off if no target is present</p>
<p><b>Step 2</b></p> <p><b>Set First Limit (Near or Far)</b> Place the target at the first limit and press the push button for less than 2 seconds</p>	<p>Push for <math>&lt; 2</math> Seconds</p> 	<p><b>Green:</b> Remains OFF</p> <p><b>Yellow:</b> Flashes at 2 Hz to indicate ready for teaching second limit</p> <p><b>Red:</b> Comes ON steady for a moment, then resumes flashing to indicate echo strength</p>
<p><b>Step 3</b></p> <p><b>Set Second Limit (Far or Near)</b> Place the target at the second limit and press the push button for less than 2 seconds</p> <p>If the target is held at the same position for programming of both limits, the sensor will establish a 5 mm-wide sensing window, centered on the target position</p>	<p>Push for <math>&lt; 2</math> Seconds</p> 	<p><b>Green:</b> Remains OFF, then comes ON steady (returns to RUN mode)</p> <p><b>Yellow:</b> ON steady for a moment, then either ON or OFF to indicate output state (returns to RUN mode)</p> <p><b>Red:</b> Comes ON steady for a moment, then resumes flashing to indicate echo strength (returns to RUN mode)</p>

## NOTES:

- 1) Either the near or far limit may be programmed first.
- 2) There is a 2 minute time-out for programming of the first limit. If more than 2 minutes elapses, the sensor will return to RUN mode with the previously programmed limits. There is no time-out between programming of the first and second limit.
- 3) The programming sequence may be cancelled at any time by pressing and holding the push button for  $\geq 2$  seconds. The sensor returns to RUN mode with the previously programmed limits.
- 4) During limit programming, the 5-segment moving dot indicator displays the relative target position between 50 and 250 mm (the maximum recommended far limit position is 250 mm).
- 5) If the target is farther than 250 mm, the 5th segment of the moving dot indicator flashes to indicate that a valid echo is received, but the target is beyond the recommended 250 mm maximum far limit.
- 6) If a limit is rejected during either programming step, the sensor will revert to the first limit programming step (end of Step 1 in programming chart). This will be indicated by: Green OFF, Red Flashing to indicate signal strength, and Yellow ON steady.
- 7) If both limits are accepted, the sensor will return to RUN mode, indicated by: Green goes ON steady.

# U-GAGE™ Analog Q45UR Remote Ultrasonic Sensors

## Remote Window Limit Programming

The yellow wire of the Analog Q45UR may be connected to a switch or process controller for remote programming of the sensing window limits. The programming procedure is the same as for the push button (see page 4).

A remote programming input is generated when +5 to 24V dc is applied to the yellow wire. The timing diagrams, right, define the required input pulses.

### NOTES:

- 1) The push button is disabled during remote limit programming. (The remote programming input is disabled during push button programming.)
- 2) Also see the notes regarding window limit programming on page 4.

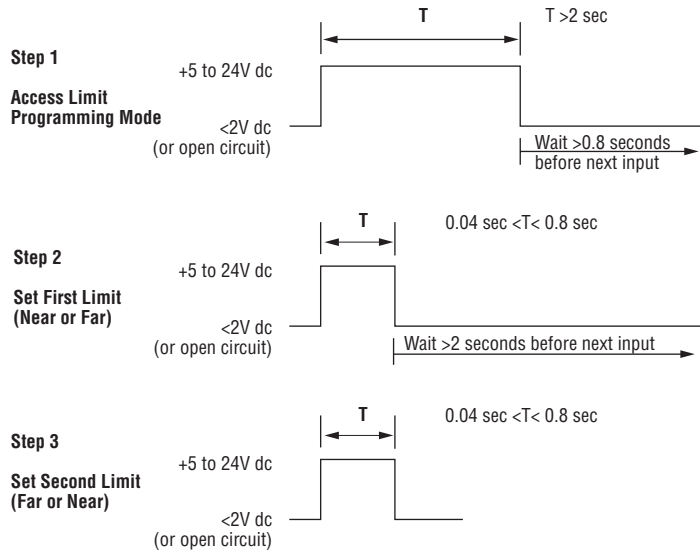

## Analog Q45UR Series Response Curves

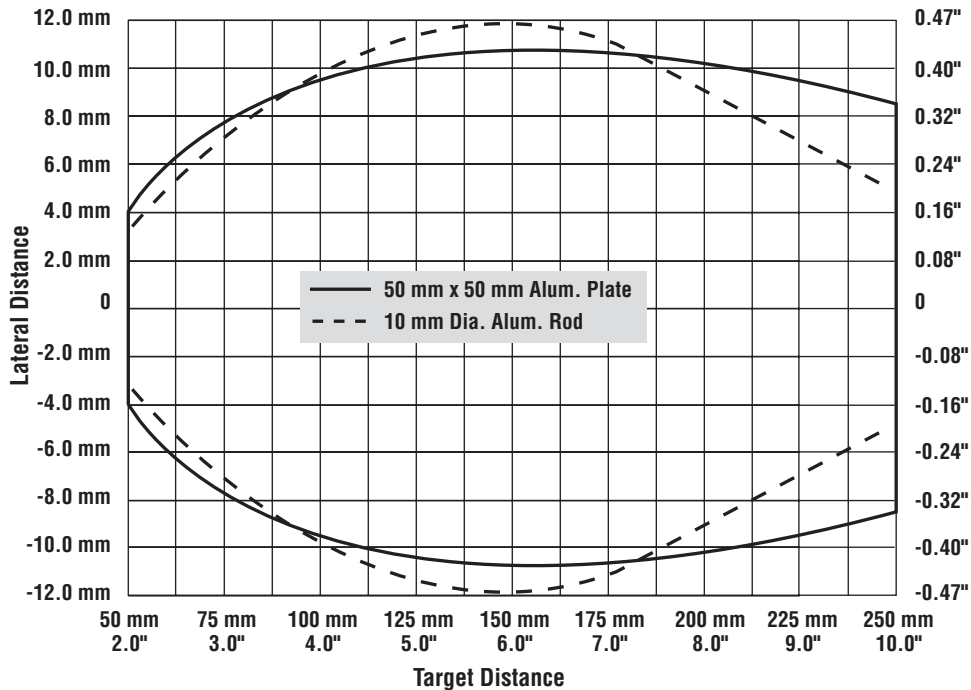

**NOTE:** The pattern displayed for the 50 mm x 50 mm Aluminum plate is referenced to the **EDGE** of the plate. The pattern displayed for the 10 mm dia. Aluminum rod is referenced to the **CENTER** of the rod.

# U-GAGE™ Analog Q45UR Remote Ultrasonic Sensors

## Analog Q45UR Series Specifications

<b>Range for Nominal Sensing Position</b>	<b>Near Limit:</b> 50 mm (2") min. <b>Far Limit:</b> 250 mm (10") max.
<b>Supply Voltage and Current</b>	15 to 24V dc (10% maximum ripple) at 100 mA, exclusive of load
<b>Supply Protection Circuitry</b>	Protected against reverse polarity and transient voltages
<b>Output Configuration</b>	One voltage sourcing and one current sourcing; one or the other output is enabled by internal programming switch #2 (see page 2).
<b>Output Rating</b>	<b>Voltage Sourcing:</b> 0 to 10V dc, 10mA maximum <b>Current Sourcing:</b> 4 to 20mA, 1 to 500 ohm impedance
<b>Output Protection Circuitry</b>	Both outputs are protected against continuous overload and short circuit
<b>Performance Specifications</b>	<p><b>Resolution*:</b> 0.2% of sensing distance at 320 ms response 0.4% of sensing distance at 10 ms response</p> <p><b>Linearity*:</b> ±1.0 mm (0.04") with 100 to 200 mm sensing window ±2.0 mm (0.08") with 50 to 250 mm sensing window</p> <p><b>Temperature stability:</b> ±0.03% of sensing distance per °C from 0 to 50°C (±0.05% per °C over remainder of operating temperature)</p> <p><b>Ultrasonic beam angle:</b> ±3.5° Also see response curve on page 5</p> <p>Minimum target size is specified as a 10 x 10 mm (0.4" x 0.4") aluminum plate (at any point within the 50 to 150 mm sensing range).</p>
<b>Adjustments</b>	<p>Push-button TEACH-mode programming of window limits (see page 2)</p> <p>The following may be selected by a 4-position DIP switch located on top of the controller, beneath the transparent acrylic and black inner covers (see page 2)</p> <p><b>Switch 1:</b> Output slope: output value increases or decreases with distance</p> <p><b>Switch 2:</b> Output mode: current output or voltage output</p> <p><b>Switches 3&amp;4:</b> Response to loss of echo: (see page 3)</p> <p><b>Response Speed Adjustment:</b> Single-turn potentiometer selects six response values from 10 to 320 milliseconds (see page 3)</p>
<b>Indicators</b>	<p><b>Three status LEDs:</b></p> <p><b>Green ON steady</b> = Power to controller is ON</p> <p><b>Green flashing</b> = Current output fault detected (indicates that the 4-20 mA current path to ground has been opened)</p> <p><b>Yellow ON steady</b> = Target is sensed within the window limits (Yellow LED also indicates programming status during setup mode)</p> <p><b>Red flashing</b> = Relative strength of received echo</p> <p><b>5-segment moving dot LED</b> indicates the position of the target within the sensing window</p>
<b>Construction</b>	<p><b>Controller:</b> Molded thermoplastic polyester housing, o-ring sealed transparent acrylic top cover, and stainless steel hardware</p> <p><b>Sensors:</b> <b>M18C2.0:</b> Stainless steel M18 threaded barrel housing and jam nuts, ULTEM® polyetherimide front cover, ceramic transducer, TEXIN® polyurethane rear cover</p> <p><b>S18C2.0:</b> Thermoplastic polyester S18 threaded barrel housing and jam nuts, ULTEM® polyetherimide front cover, ceramic transducer, TEXIN® polyurethane rear cover</p> <p><b>Q13C2.0:</b> Molded 30% glass reinforced thermoplastic polyester housing, ceramic transducer, fully epoxy-encapsulated</p>
<b>Environmental Rating</b>	<b>Controller:</b> IEC IP67; NEMA 6P <b>Sensor:</b> IEC IP65; NEMA 4

ULTEM® is a registered trademark of General Electric  
TEXIN® is a registered trademark of Bayer Corporation

# U-GAGE™ Analog Q45UR Remote Ultrasonic Sensors

## Analog Q45UR Series Specifications, continued

<b>Connections</b>	<b>Controller:</b> 2m (6.5') or 9 m (30') attached cable, or 5-pin Mini-style or Euro-style quick-disconnect fitting <b>Sensor:</b> 2m (6.5') attached PVC cable terminated with 4-pin Euro-style quick-disconnect fitting for connection to controller
<b>Operating Temperature</b>	<b>Controller and sensor:</b> -25° to +70°C (-13° to +158°F) <b>Maximum relative humidity:</b> 85% (non-condensing)
<b>Vibration and Mechanical Shock</b>	All models meet Mil. Std. 202F requirements. Method 201A Vibration: 10 to 60Hz max., double amplitude 0.06" (maximum acceleration 10G). Method 213B conditions H & I (Shock: 75G with unit operating; 100G for non-operation). Also meets IEC 947-5-2 requirements: 30G, 11 ms duration, half sine wave.
<b>Certifications</b>	CE
<b>Application Notes</b>	The controller has non-volatile memory which remembers the last sensing window setting if power is removed and later reapplied. The sensing window may be programmed via the Remote Teach input (see hookup diagrams). Acceptable target angle is within $\pm 5^\circ$ of normal for a smooth, flat target; target rotation does affect the apparent target location with respect to the sensor.

## Q45UR Series Controller Hookups

**Q45UR Controller with Attached Cable**

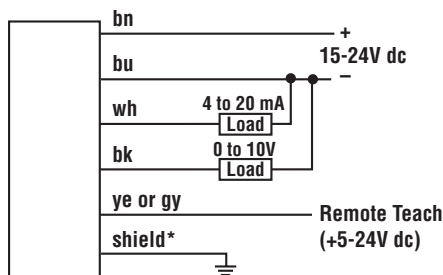

**Q45UR Controller with 5-Pin Mini-Style QD ("Q" Model Suffix)**

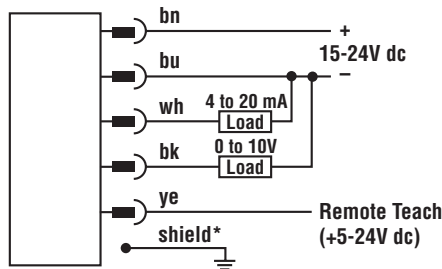

**Q45UR Controller with 5-Pin Euro-Style QD ("Q6" Model Suffix)**

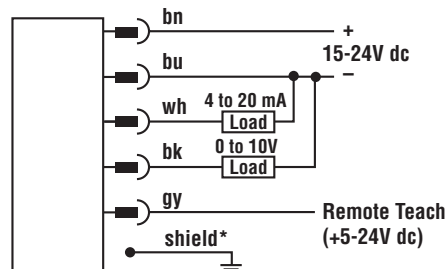

\* It is recommended that the shield wire be connected to earth ground or dc common.

**5-Pin Mini-Style Pin-Out (Cable Connector Shown)**

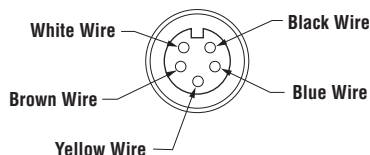

**5-Pin Euro-Style Pin-Out (Cable Connector Shown)**

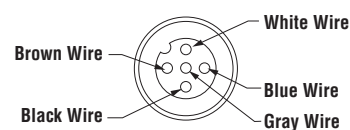



# U-GAGE™ Analog Q45UR Remote Ultrasonic Sensors

## Q45UR Series Controller Dimensions

### Q45UR Controller with Attached Cable

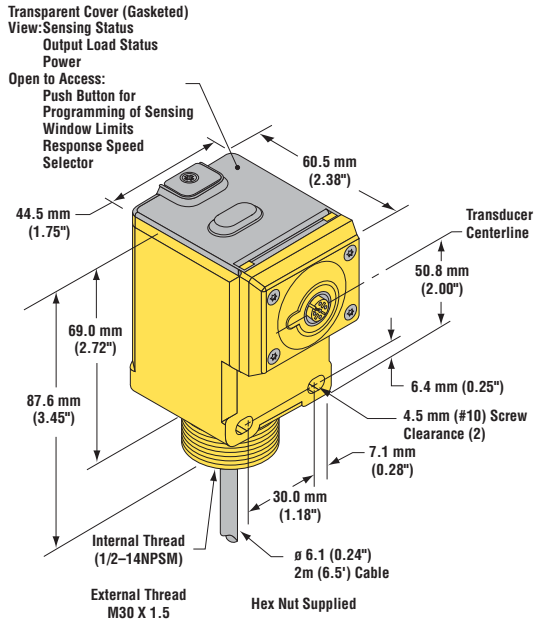

### Q45UR Controller with 5-Pin Mini-Style QD ("Q" model Suffix)

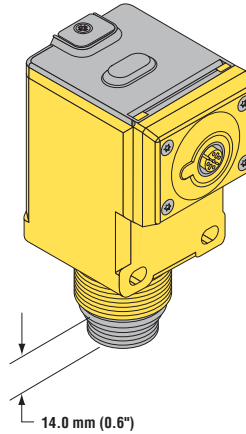

### Q45UR Controller with 5-Pin Euro-Style QD ("Q6" model Suffix)

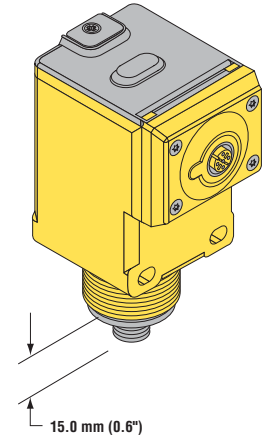

## Remote Sensor Dimensions

### M18C2.0 and S18C2.0 Sensors

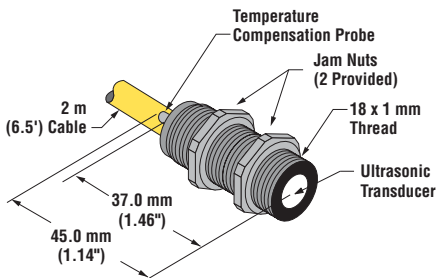

### Q13C2.0 Sensors

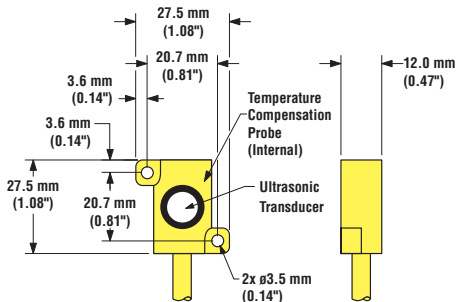

## Accessories

### Quick-disconnect (QD) Cables

Description	Model	Length	Connector
5-Pin Mini-style with shield	MBCC2-506 MBCC2-512 MBCC2-530	2 m (6.5') 4 m (12') 9 m (30')	
5-Pin Euro-style Straight with shield	MQDEC2-506 MQDEC2-515 MQDEC2-530	2 m (6.5') 5 m (15') 9 m (30')	
5-Pin Euro-style Right-angle with shield	MQDEC2-506RA MQDEC2-515RA MQDEC2-530RA	2 m (6.5') 5 m (15') 9 m (30')	

# U-GAGE™ Analog Q45UR Remote Ultrasonic Sensors

## Mounting Brackets for Q45UR Series Controllers

<p><b>SMB30S</b></p>	<ul style="list-style-type: none"> <li>• 30 mm swivel, black PBT polyester bracket</li> <li>• Stainless steel mounting hardware included</li> </ul>	<p><b>SMB30C</b></p>	<ul style="list-style-type: none"> <li>• 30 mm split clamp, black PBT polyester bracket</li> <li>• Stainless steel mounting hardware included</li> </ul>
<p><b>SMB30MM</b></p>	<ul style="list-style-type: none"> <li>• 30 mm, 11-gauge stainless steel bracket</li> <li>• Curved mounting slots for versatility and orientation</li> </ul>		

# U-GAGE™ Analog Q45UR Remote Ultrasonic Sensors

## Mounting Brackets for M18C2.0 and S18C2.0 Sensors

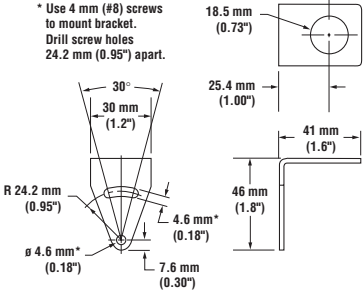
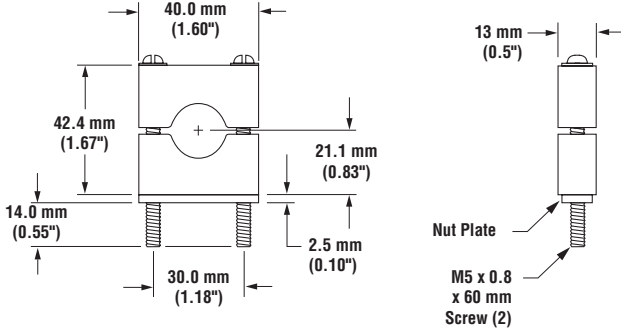
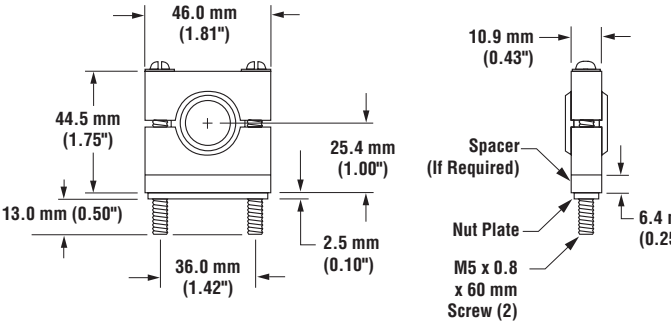
<p><b>SMB18A</b></p>	<ul style="list-style-type: none"> <li>• 11-gauge, stainless steel right-angle bracket</li> <li>• Curved mounting slot for versatility and orientation</li> </ul>	<p><b>SMB18C</b></p>	<ul style="list-style-type: none"> <li>• 18 mm split clamp black PBT polyester bracket</li> <li>• Stainless steel mounting hardware included</li> </ul>
 <p>* Use 4 mm (#8) screws to mount bracket. Drill screw holes 24.2 mm (0.95") apart.</p> <p>30° 30 mm (1.2") R 24.2 mm (0.95") 4.6 mm* (0.18") 7.6 mm (0.30") 18.5 mm (0.73") 25.4 mm (1.00") 41 mm (1.6") 46 mm (1.8")</p>		 <p>40.0 mm (1.60") 42.4 mm (1.67") 14.0 mm (0.55") 30.0 mm (1.18") 21.1 mm (0.83") 2.5 mm (0.10") 13 mm (0.5") Nut Plate M5 x 0.8 x 60 mm Screw (2)</p>	
<p><b>SMB18S</b></p>	<ul style="list-style-type: none"> <li>• 18 mm swivel, black PBT polyester bracket</li> <li>• Stainless steel mounting hardware included</li> </ul>	 <p>46.0 mm (1.81") 44.5 mm (1.75") 13.0 mm (0.50") 36.0 mm (1.42") 25.4 mm (1.00") 2.5 mm (0.10") 10.9 mm (0.43") 6.4 mm (0.25") Spacer (If Required) Nut Plate M5 x 0.8 x 60 mm Screw (2)</p>	

# U-GAGE™ Analog Q45UR Remote Ultrasonic Sensors

---



## **WARNING . . . Not To Be Used for Personnel Protection**

Never use these products as sensing devices for personnel protection. Doing so could lead to serious injury or death.

These sensors do NOT include the self-checking redundant circuitry necessary to allow their use in personnel safety applications. A sensor failure or malfunction can cause either an energized or de-energized sensor output condition. Consult your current Banner Safety Products catalog for safety products which meet OSHA, ANSI and IEC standards for personnel protection.

## **Banner Engineering Corp Limited Warranty**

---

Banner Engineering Corp. warrants its products to be free from defects in material and workmanship for one year following the date of shipment. Banner Engineering Corp. will repair or replace, free of charge, any product of its manufacture which, at the time it is returned to the factory, is found to have been defective during the warranty period. This warranty does not cover damage or liability for misuse, abuse, or the improper application or installation of the Banner product.

**THIS LIMITED WARRANTY IS EXCLUSIVE AND IN LIEU OF ALL OTHER WARRANTIES WHETHER EXPRESS OR IMPLIED (INCLUDING, WITHOUT LIMITATION, ANY WARRANTY OF MERCHANTABILITY OR FITNESS FOR A PARTICULAR PURPOSE), AND WHETHER ARISING UNDER COURSE OF PERFORMANCE, COURSE OF DEALING OR TRADE USAGE.**

This Warranty is exclusive and limited to repair or, at the discretion of Banner Engineering Corp., replacement. **IN NO EVENT SHALL BANNER ENGINEERING CORP. BE LIABLE TO BUYER OR ANY OTHER PERSON OR ENTITY FOR ANY EXTRA COSTS, EXPENSES, LOSSES, LOSS OF PROFITS, OR ANY INCIDENTAL, CONSEQUENTIAL OR SPECIAL DAMAGES RESULTING FROM ANY PRODUCT DEFECT OR FROM THE USE OR INABILITY TO USE THE PRODUCT, WHETHER ARISING IN CONTRACT OR WARRANTY, STATUTE, TORT, STRICT LIABILITY, NEGLIGENCE, OR OTHERWISE.**

Banner Engineering Corp. reserves the right to change, modify or improve the design of the product without assuming any obligations or liabilities relating to any product previously manufactured by Banner Engineering Corp.



**more sensors, more solutions**