

U-GAGE QT50ULB Series Sensors with Analog Output

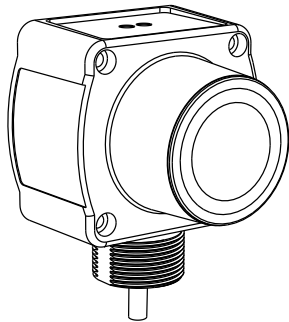

Datasheet



Long-range ultrasonic sensors with TEACH-mode programming

- Fast, easy-to-use TEACH-Mode programming; no potentiometer adjustments
- Scalable output automatically distributes the output signal over the width of the programmed sensing window
- Minimum and Maximum window limits can be adjusted independently
- Selectable 0 to 10 V dc or 4 to 20 mA output, selected via DIP switch
- Access to bank of 8 DIP switches through sealed cover for superior user functionality
- Rugged encapsulated design for harsh environments
- Unique housing design allows for multiple mounting configurations
- Choose models with integral 2 m (6.5 ft) or 9 m (30 ft), or with Mini-style or Euro-style quick-disconnect fitting
- Wide operating range of $-20\text{ }^{\circ}\text{C}$ to $70\text{ }^{\circ}\text{C}$ ($-4\text{ }^{\circ}\text{F}$ to $158\text{ }^{\circ}\text{F}$)
- Temperature compensation
- Programmable for either positive or negative output slope

| Models ¹ | Sensing Range | Cable ² | Supply Voltage | Output |
|---------------------|-------------------------------------|----------------------------|----------------|--|
| QT50ULB | 200 mm to 8 m (8 inches to 26 feet) | 5-wire, 2 m (6.5 ft) cable | 10 to 30 V dc | Selectable: 0 to 10 V dc or 4 to 20 mA |
| QT50ULBQ | | 5-pin Mini-style QD | | |
| QT50ULBQ6 | | 5-pin Euro-style QD | | |



WARNING: Not To Be Used for Personnel Protection

Never use this device as a sensing device for personnel protection. Doing so could lead to serious injury or death. This device does not include the self-checking redundant circuitry necessary to allow its use in personnel safety applications. A sensor failure or malfunction can cause either an energized or de-energized sensor output condition.

Principles of Operation

Ultrasonic sensors emit one or multiple pulses of ultrasonic energy, which travel through the air at the speed of sound. A portion of this energy reflects off the target and travels back to the sensor. The sensor measures the total time required for the energy to reach the target and return to the sensor. The distance to the object is then calculated using the following formula: $D = ct \div 2$

D = distance from the sensor to the target

c = speed of sound in air

t = transit time for the ultrasonic pulse

To improve accuracy, an ultrasonic sensor may average the results of several pulses before outputting a new value.

Temperature Effects

The speed of sound is dependent upon the composition, pressure and temperature of the gas in which it is traveling. For most ultrasonic applications, the composition and pressure of the gas are relatively fixed, while the temperature may fluctuate.

In air, the speed of sound varies with temperature according to the following approximation:

¹ Information about discrete-output models is available on Banner's website: www.bannerengineering.com.

² To order the 9 m cable models, add the suffix "w/30" to the model number of a cabled sensor (e.g., QT50ULB w/30). Models with a QD connector require a mating cable.



In metric units:

$$C_{m/s} = 20 \sqrt{273 + T_C}$$

$C_{m/s}$ = speed of sound in meters per second

T_C = temperature in °C

In English units:

$$C_{ft/s} = 49 \sqrt{460 + T_F}$$

$C_{ft/s}$ = speed of sound in feet per second

T_F = temperature in °F

The speed of sound changes roughly 1% per 6° C (10° F). QT50U series ultrasonic sensors have temperature compensation available, via the 8-pin DIP switch. Temperature compensation will reduce the error due to temperature by about 90%.



NOTE: NOTE: If the sensor is measuring across a temperature gradient, the compensation will be less effective.

Analog Output Slope

The U-GAGE QT50ULB Sensor may be programmed for either a positive or a negative output slope, depending on which conditions are taught for the Min and Max Analog limits. If the Min Analog limit is the Near Window setting and the Max Analog limit is the Far Window setting, then the slope will be positive. If the opposite is true, then the slope will be negative.

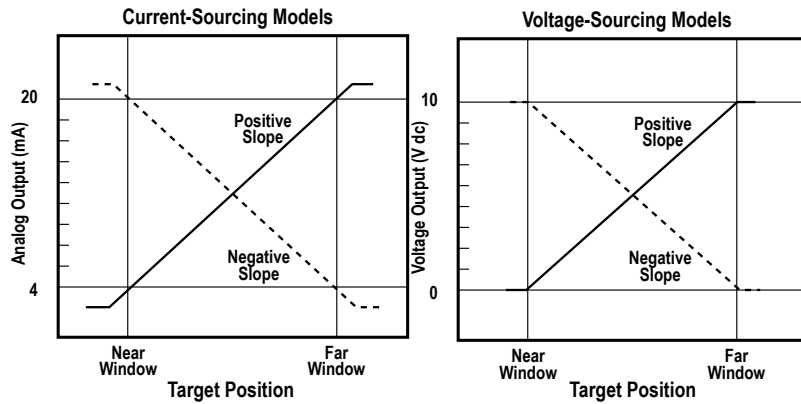

Figure 1. Positive and Negative Output Slops

Configuration

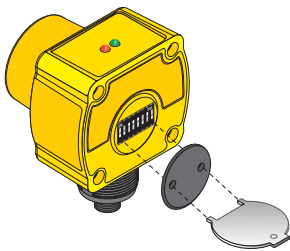

Figure 2. Removing the Access Cover

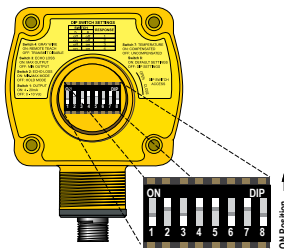

Figure 3. DIP Switch Location

The U-GAGE QT50ULB Sensor features an 8-pin DIP switch bank for user setup. The DIP switches are located behind the access cover on the back of the sensor as shown. A spanner tool is included with each sensor for removing the cover.

| Switch | Function | Settings |
|--------|----------------------|-----------------------------------|
| 1 | Voltage/Current Mode | ON = Current mode: 4 to 20 mA |
| | | OFF* = Voltage mode: 0 to 10 V dc |
| 2 | Loss of Echo | ON* = Min-Max Mode |

| Switch | Function | Settings | |
|---------|---|--|----------|
| | | OFF = Hold Mode | |
| 3 | Min-Max | ON = Default to maximum output value on loss of echo | |
| | | OFF* = Default to minimum output value on loss of echo | |
| 4 | Teach/Enable Control | ON* = Configured for remote teach | |
| | | OFF = Configured for enable | |
| 5 and 6 | Analog Voltage Output Response for 95% of Step Change | Switch 5 | Switch 6 |
| | 100 ms with 100 ms update | OFF | OFF |
| | 500 ms with 100 ms update* | ON* | OFF* |
| | 1100 ms with 100 ms update | OFF | ON |
| | 2300 ms with 100 ms update | ON | ON |
| 7 | Temperature Compensation | ON* = Enabled | |
| | | OFF = Disabled | |
| 8 | Factory Calibration | ON = For factory calibration only; switch should be set to OFF for use | |
| | | OFF* = DIP-switch settings in control | |

* Factory default setting

DIP Switch Selectable Functions



CAUTION: To avoid damage to the sensor caused by static discharge (ESD), observe proper ESD precautions (grounding) while adjusting the DIP switches.

Switch 1: Output Mode Select

ON = 4 to 20 mA current output is enabled
 OFF = 0 to 10 V dc voltage output is enabled

Switch 1 configures the sensor internally to use either the current output or voltage output configuration.

Switch 2: Loss of Echo Mode Select

ON = Min-Max Mode
 OFF = Hold Mode

Switch 2 determines the output response to the loss of echo. "Min-Max Mode" (Switch 2 ON) drives the output to either the minimum value or the maximum value when the echo is lost. (Minimum or Maximum value is selected via Switch 3.)

"Hold Mode" (Switch 2 OFF) maintains the output at the value which was present at the time of echo loss.

Switch 3: Min-Max Default

ON = Default to maximum output value at loss of echo (10.5 V dc or 20.8 mA)
 OFF = Default to minimum output value at loss of echo (0 V dc or 3.6 mA)

Switch 3 selects the output response to loss of echo when "Min-Max Mode" is selected via Switch 2. When Switch 2 is OFF, Switch 3 has no function.

Switch 4: Teach/Transmit Enable Control

ON = Gray (or yellow) wire configured for remote teach
 OFF = Gray (or yellow) wire configured for transmit enable/disable: High (5 to 30 V dc) - Transmit Enabled (Power LED solid Green); Low (0 to 2 V dc) - Transmit Disabled (Power LED flashes at 2 Hz)

When Switch 4 is ON, the gray wire is used to teach window limits to the sensors.

When Switch 4 is OFF, the gray wire is used to enable and disable the sensor's transmit burst. The sensor output will react as if a "loss of echo" occurred and either hold the output or change to minimum or maximum value (depending on switch 2 and 3 settings). This function may be used when multiple sensors are in close proximity, which may make them vulnerable to crosstalk interference. A PLC can be used to enable the sensors one at a time to avoid crosstalk.

Switches 5 and 6: Response Speed Adjustment

Switches 5 and 6 are used to set the speed of the output response. The four values for response speed relate to the number of sensing cycles over which the output value is averaged.

Switch 7: Temperature Compensation

- ON = Temperature compensation enabled
- OFF = Temperature compensation disabled

Changes in air temperature affect the speed of sound, which in turn affects the distance reading measured by the sensor. An increase in air temperature shifts both sensing window limits closer to the sensor. Conversely, a decrease in air temperature shifts both limits farther away from the sensor. This shift is approximately 3.5% of the limit distance for a 20 °C change in temperature. With temperature compensation enabled (Switch 7 ON), the sensor will maintain the window limits to within 1.8 percent over the -20 °C to 70 °C range.

The temperature sensor in the sensor's bezel cannot adapt to temperature change as quickly as an external temperature device can. When there are fast fluctuations in temperature, it may be best to use an external temperature monitor and feed its signal and the uncompensated distance measurement into a controller and perform the compensation calculations within the controller.

Consult the factory for details on performing temperature compensation calculations.

- If temperature compensation is enabled, exposure to direct sunlight can affect the sensor's ability to accurately compensate for changes in temperature.
- With temperature compensation enabled, the temperature warmup drift upon power-up is less than 0.8% of the sensing distance. After 15 minutes, the apparent distance will be within 0.5% of the actual distance. After 30 minutes, the apparent distance will be within 0.3% of the actual distance.

Switch 8: Factory Calibration

- ON = Factory calibration only
- OFF = Normal operation

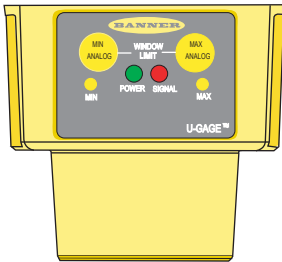

Figure 4. Sensor Features

- MIN - Minimum limit indicator
- MAX - Maximum limit indicator
- POWER - Sensor power indicator
- SIGNAL - Target signal strength indicator

General Notes on Programming

- The sensor returns to RUN mode if the limit is not registered within 120 seconds after entering TEACH Mode.
- Press and hold the programming push button for more than 2 seconds (before teaching the limit) to exit PROGRAM mode without saving any changes. The sensor will revert to the last saved program.
- If the push buttons do not respond, perform a remote lockout procedure to enable push buttons.

Sensor Programming

Two TEACH methods may be used to program the sensor:

- Teach individual minimum and maximum limits
- Use the Auto-Window feature to center a sensing window around the taught position

The sensor may be programmed either via its two push buttons, or via a remote switch. Remote programming also may be used to disable the push buttons, preventing unauthorized personnel from adjusting the programming settings. To access this feature, connect the gray wire of the sensor to 0–2 V dc, with a remote programming switch between the sensor and the voltage.



NOTE: The impedance of the Remote Teach input is 12 kΩ.

Programming is accomplished by following the sequence of input pulses. The duration of each pulse (corresponding to a push button "click"), and the period between multiple pulses, are defined as "T" where 0.04 seconds < T < 0.8 seconds.

Teaching Minimum and Maximum Limits

The Min and Max Analog limits are independent. To readjust either limit, it is necessary to follow the teach procedure for that limit only.

Setting the Minimum Analog Limit

| Push Button Method | | |
|--------------------|--|--|
| Step | Action | Result |
| 1 | Push and hold the Min Analog button | Min Analog LED turns ON red; sensor is waiting for 0 V dc or 4 mA limit. |
| 2 | Position the target for the Min Analog limit | Sensor learns Min limit |
| 3 | "Click" the Min Analog button | Min LED changes from red to amber or flashing amber |

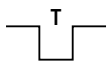
| Remote Line Method (0.04 s < T < 0.8 s) | | |
|---|--|--|
| Step | Action | Result |
| 1 | Position the target for the Min Analog limit | Sensor learns the 0 V dc or 4 mA limit |
| 2 | Single-pulse the remote line  | Min Analog LED flashes red once |

Setting the Maximum Analog Limit

| Push Button Method | | |
|--------------------|--|--|
| Step | Action | Result |
| 1 | Push and hold the Max Analog button | Max Analog LED turns ON red; sensor is waiting for 10 V dc or 20 mA limit. |
| 2 | Position the target for the Max Analog limit | Sensor learns Max limit |
| 3 | "Click" the Max Analog button | Max LED changes from red to amber or flashing amber |

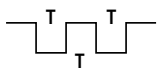
| Remote Line Method (0.04 s < T < 0.8 s) | | |
|---|--|--|
| Step | Action | Result |
| 1 | Position the target for the Max Analog limit | Sensor learns the 10 V dc or 20 mA limit |
| 2 | Double-pulse the remote line  | Max Analog LED flashes red once |

Teaching Limits Using the Auto-Window Feature

Teaches a sensing distance threshold centered within a fixed sensing window (a 1 m window centered on the position taught). This procedure centers the analog output on the taught position at approximately 5 V dc or 12 mA.

Setting the Minimum Analog Limit

| Push Button Method | | |
|--------------------|-------------------------------------|---|
| Step | Action | Result |
| 1 | Push and hold the Min Analog button | Min Analog LED turns ON red |
| 2 | "Click" the Max Analog button | Max Analog LED turns ON red (both the Min and Max Analog LEDs should now be ON) |

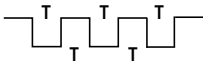
| Remote Line Method (0.04 s < T < 0.8 s) | | |
|---|--|---|
| Step | Action | Result |
| 1 | Position the target at the location where the midpoint of the window should be. | Min and Max LEDs both flash red (0.5 second), then turn amber |
| 2 | Triple-pulse the remote line  | |

Setting the Maximum Analog Limit

| Push Button Method | | |
|--------------------|---|---|
| Step | Action | Result |
| 1 | Position the target at the location where the midpoint of the window should be. | Its LED flashes red |
| 2 | "Click" either push button | |
| 3 | "Click" the other push button | The Red Teach LEDs change to amber and the sensor returns to RUN mode |

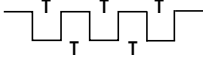
| Remote Line Method (0.04 s < T < 0.8 s) | | |
|---|---|---|
| Step | Action | Result |
| 1 | Position the target at the location where the midpoint of the window should be. | Min and Max LEDs both flash red (0.5 second), then turn amber |
| 2 | Triple-pulse the remote line  | |

Push Button Lockout

Enables or disables the keypad to prevent unauthorized personnel from adjusting the programming settings.

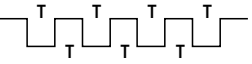
| Push Button | | Remote Line | |
|-------------------------------|----------------|---|---|
| Procedure | Result | Procedure 0.04 sec. < T < 0.8 sec. | Result |
| Not available via push button | Not applicable | Four-pulse the remote line  | Push buttons are either enabled or disabled, depending on previous condition. |

Status Indicators

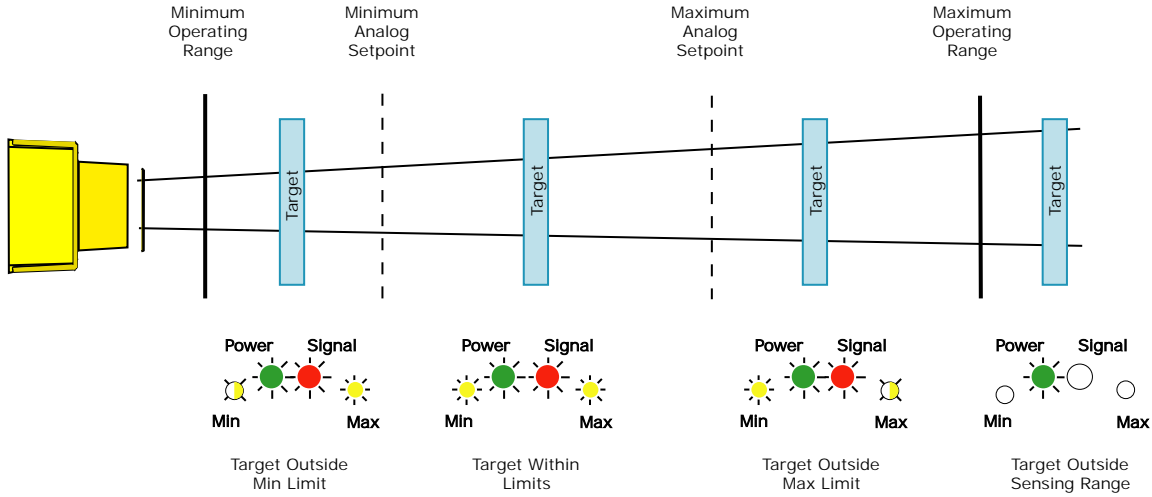

Figure 5. Status Indicator Conditions for Each Target Position

| Signal LED (Red) – indicates the strength and condition of the sensor’s incoming signal. | |
|--|--|
| Signal LED Status | Indicates |
| ON Bright | Good signal |
| ON Dim | Marginal signal strength |
| OFF | No signal is received or the target is beyond the sensor’s range limitations |

| Output LEDs (Amber) – indicate the position of the target relative to the window limits. | |
|--|---|
| Output/Teach LED | Indicates |
| ON Red (either) | In Teach mode; waiting for limits to be taught |
| Min Analog ON Amber Max Analog ON Amber | Target is within analog window limits |
| Min Analog ON Amber Max Analog Flashing Amber | Target is outside max. window limit |
| Min Analog Flashing Amber Max Analog ON Amber | Target is outside Min window limit |
| Min Analog OFF Max Analog OFF | No signal condition or Outside operating limits |

| Power ON/OFF LED (Green) – indicates the operating status of the sensor. | |
|--|---|
| Power ON/OFF LED | Indicates |
| OFF | Power is OFF |
| Flashing at 2 Hz | Transmit disabled (see DIP switch settings) |
| ON Solid | Sensor is operating normally |

Wiring

| Integral Cable Model | Quick-Disconnect Model (5-pin Mini-style) | Quick-Disconnect Model (5-pin Euro-style) |
|--|--|--|
| | | |
| <p>1 = brown 2 = white 3 = blue 4 = black 5 = gray</p> | <p>1 = brown 2 = white 3 = blue 4 = black 5 = yellow</p> | <p>1 = brown 2 = white 3 = blue 4 = black 5 = gray</p> |

Banner recommends connecting the shield wire to earth ground or dc common.

Dimensions

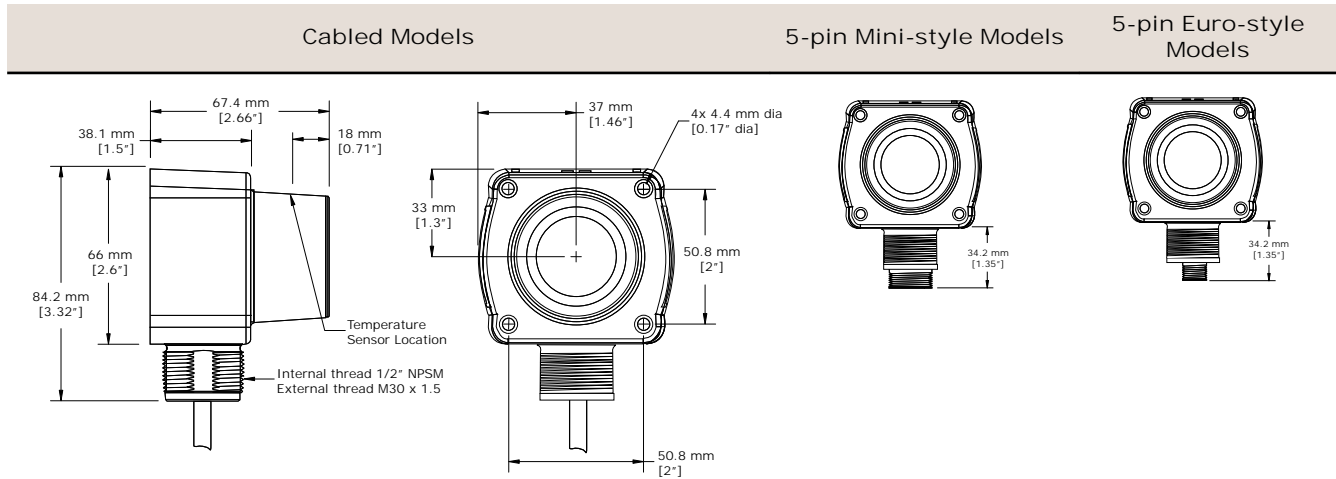

Specifications

Supply Voltage and Current

10 to 30 V dc (10% maximum ripple)
100 mA max at 10 V, 40 mA max at 30 V (exclusive of load)

Sensing Range

200 mm to 8 m (8 inches to 26 feet)

Ultrasonic Frequency

75 kHz burst, rep. rate 96 ms

Supply Protection Circuitry

Protected against reverse polarity and transient overvoltages

Output Protection

Protected against short circuit conditions

Delay at Power-up

1.5 seconds

Analog Output Configuration (Voltage Sourcing: 0 to 10 V dc)

Minimum Load Resistance = 500 ohms
Minimum Required Supply Voltage for Full 0-10 V Output Span = $(1000/R_{Load} + 13)$ V dc

Analog Output Configuration (Current Sourcing: 4 to 20 mA)

Maximum Load Resistance = 1 k Ω or $(V_{supply}/0.02 - 5)$ ohms, whichever is lower
Minimum required supply voltage for full 4-20 mA output span = 10 V dc or $[(R_{Load} \times 0.02) + 5]$ V dc, whichever is greater.
4 to 20 mA output calibrated at 25 °C with a 250 Ω load.

Temperature Effect

Uncompensated: 0.2% of distance/°C
Compensated: 0.02% of distance/°C

Linearity

+/- 0.2% of span from 200 to 8000 mm
+/- 0.1% of span from 500 to 8000 mm (1 mm minimum)

Resolution

1.0 mm

Output Response Time

100 ms to 2300 ms
See DIP Switches 5 and 6

Minimum Window Size

20 mm

Adjustments

Sensing window limits: TEACH-Mode programming of near and far window limits may be set using the push buttons or remotely via TEACH input.

Indicators

Green Power On LED: Indicates power is ON
Red Signal LED: Indicates target is within sensing range, and the condition of the received signal
Teach/Output indicator (bicolor Amber/Red): Amber – Target is within taught limits; Flashing Amber – Target is outside taught window limits; Red – Sensor is in TEACH mode

Remote TEACH

To Teach: Connect gray or yellow wire to 0 to 2 V dc; impedance 12 k Ω

Construction

Transducer: Ceramic/Epoxy composite
Housing: ABS/Polycarbonate
Membrane Switch: Polyester
Lightpipes: Acrylic

Operating Conditions

Temperature: -20 °C to 70 °C (-4 °F to 158 °F)
Maximum relative humidity: 100%

Connections

2 m (6.5 ft) or 9 m (30 ft) shielded 5-conductor (with drain) PVC jacketed attached cable or 5-pin Euro-style quick-disconnect or 5-pin Mini-style quick-disconnect

Environmental Rating

Leakproof design is rated IEC IP67; NEMA 6P

Vibration and Mechanical Shock

All models meet Mil Std. 202F requirements. Method 201A (vibration: 10 to 60Hz max., double amplitude 0.06", maximum acceleration 10G). Also meets IEC 947-5-2 requirements: 30G 11 ms duration, half sine wave

Temperature Warmup Drift

Less than 0.8% of sensing distance upon power-up with Temperature Compensation enabled (see Temperature Compensation)

Application Notes

Objects passing inside the specified near limit (200 mm) may produce a false response.

Certifications



Performance Curves

QT50U Effective Beam Pattern

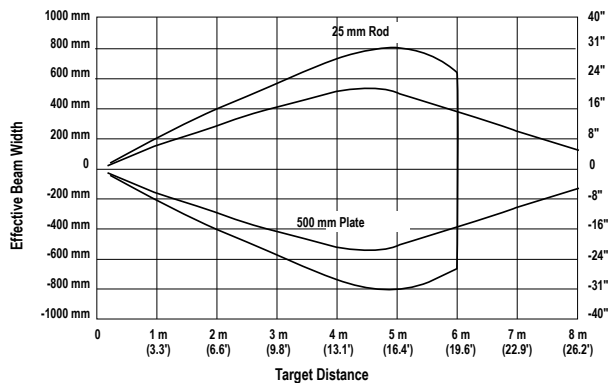

QT50U (with 500 mm Plate) Maximum Target Rotation Angle

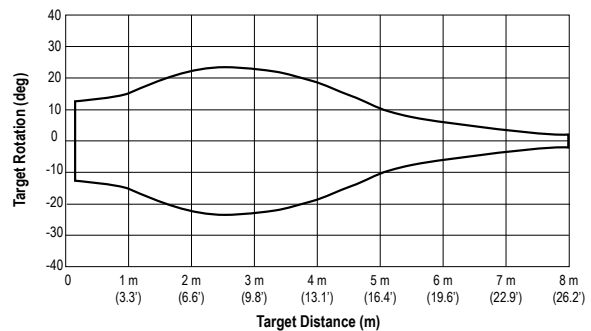

Accessories

| 5-Pin Mini-Style Cordsets with Shield | | | | |
|---------------------------------------|----------------|----------|------------|--|
| Model | Length | Style | Dimensions | Pinout (Female) |
| MBCC2-506 | 1.83 m (6 ft) | Straight | | <p>1 = Brown 2 = White 3 = Blue 4 = Black 5 = Yellow</p> |
| MBCC2-515 | 4.57 m (15 ft) | | | |
| MBCC2-530 | 9.14 m (30 ft) | | | |

| 5-Pin Threaded M12/Euro-Style Cordsets with Shield | | | | |
|--|----------------|-------------|------------|--|
| Model | Length | Style | Dimensions | Pinout |
| MQDEC2-506 | 1.83 m (6 ft) | Straight | | <p>1 = Brown 2 = White 3 = Blue 4 = Black 5 = Gray</p> |
| MQDEC2-515 | 4.57 m (15 ft) | | | |
| MQDEC2-530 | 9.14 m (30 ft) | | | |
| MQDEC2-550 | 15.2 m (50 ft) | Right-Angle | | <p>1 = Brown 2 = White 3 = Blue 4 = Black 5 = Gray</p> |
| MQDEC2-506RA | 1.83 m (6 ft) | | | |
| MQDEC2-515RA | 4.57 m (15 ft) | | | |
| MQDEC2-530RA | 9.14 m (30 ft) | | | |
| MQDEC2-550RA | 15.2 m (50 ft) | | | |

| Brackets | |
|---|--|
| <p>SMB30SC</p> <ul style="list-style-type: none"> Swivel bracket with 30 mm mounting hole for sensor Black reinforced thermoplastic polyester Stainless steel mounting and swivel locking hardware included <p>Hole center spacing: A=ø 50.8 Hole size: A=ø 7.0, B=ø 30.0</p> | <p>SMB30MM</p> <ul style="list-style-type: none"> 12-ga. stainless steel bracket with curved mounting slots for versatile orientation Clearance for M6 (¼ in) hardware Mounting hole for 30 mm sensor <p>Hole center spacing: A = 51, A to B = 25.4 Hole size: A = 42.6 x 7, B = ø 6.4, C = ø 30.1</p> |

Banner Engineering Corp Limited Warranty

Banner Engineering Corp. warrants its products to be free from defects in material and workmanship for one year following the date of shipment. Banner Engineering Corp. will repair or replace, free of charge, any product of its manufacture which, at the time it is returned to the factory, is found to have been defective during the warranty period. This warranty does not cover damage or liability for misuse, abuse, or the improper application or installation of the Banner product.

THIS LIMITED WARRANTY IS EXCLUSIVE AND IN LIEU OF ALL OTHER WARRANTIES WHETHER EXPRESS OR IMPLIED (INCLUDING, WITHOUT LIMITATION, ANY WARRANTY OF MERCHANTABILITY OR FITNESS FOR A PARTICULAR PURPOSE), AND WHETHER ARISING UNDER COURSE OF PERFORMANCE, COURSE OF DEALING OR TRADE USAGE.

This Warranty is exclusive and limited to repair or, at the discretion of Banner Engineering Corp., replacement. IN NO EVENT SHALL BANNER ENGINEERING CORP. BE LIABLE TO BUYER OR ANY OTHER PERSON OR ENTITY FOR ANY EXTRA COSTS, EXPENSES, LOSSES, LOSS OF PROFITS, OR ANY INCIDENTAL, CONSEQUENTIAL OR SPECIAL DAMAGES RESULTING FROM ANY PRODUCT DEFECT OR FROM THE USE OR INABILITY TO USE THE PRODUCT, WHETHER ARISING IN CONTRACT OR WARRANTY, STATUTE, TORT, STRICT LIABILITY, NEGLIGENCE, OR OTHERWISE.

Banner Engineering Corp. reserves the right to change, modify or improve the design of the product without assuming any obligations or liabilities relating to any product previously manufactured by Banner Engineering Corp.