

T-GAGE™ M18T Series Infrared Temperature Sensors



18 mm sensor with 0-10V and 4-20mA analog output and TEACH-mode programming

For the latest technical information about this product, including specifications, dimensions, and wiring, see www.BannerEngineering.com

Features

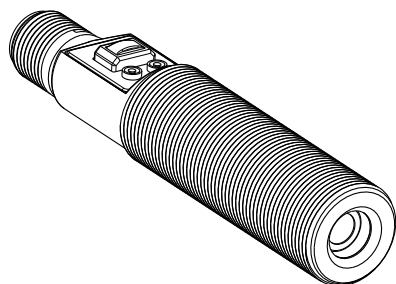

- Fast 75 ms response time
- Easy-to-use TEACH mode programming; no potentiometer adjustments
- Small self-contained package, no auxiliary controller needed
- Rugged encapsulated design for harsh environments
- Choose 2 meter or 9 meter unterminated cable, or 5-pin Euro-style QD connector
- Product motion not required for sensing
- Remote Teach available in both Static and Dynamic modes
- Alarm output for signal maximum
- Programming for either positive or negative analog slope based on teach order



Models

| Model | Cable* | D:S Ratio | Sensing Face | Supply Voltage | Output |
|-----------|-----------------------------------|-----------|---|----------------|------------------------------------|
| M18TUP8 | 5-wire, 2 m (6.5') shielded cable | 8:1 | Integrated lens | 12 to 30V dc | 0 to 10V dc analog, plus PNP Alarm |
| M18TUP8Q | 5-pin Euro-style integral QD | | | | |
| M18TUP6E | 5-wire, 2 m (6.5') shielded cable | 6:1 | Enclosed Plastic face (for food industry use) | | |
| M18TUP6EQ | 5-pin, Euro-style integral QD | | | | |
| M18TUP14 | 5-wire, 2 m (6.5') shielded cable | 14:1 | Germanium lens | | |
| M18TUP14Q | 5-pin, Euro-style integral QD | | | | |
| M18TIP8 | 5-wire, 2 m (6.5') shielded cable | 8:1 | Integrated lens | | 4 - 20 mA analog, plus PNP Alarm |
| M18TIP8Q | 5-pin Euro-style integral QD | | | | |
| M18TIP6E | 5-wire, 2 m (6.5') shielded cable | 6:1 | Enclosed Plastic face (for food industry use) | | |
| M18TIP6EQ | 5-pin, Euro-style integral QD | | | | |
| M18TIP14 | 5-wire, 2 m (6.5') shielded cable | 14:1 | Germanium lens | | |
| M18TIP14Q | 5-pin, Euro-style integral QD | | | | |

* For 9 m (30') cable, add suffix "W/30" to the model number of any cabled model (e.g., M18TUP8 W/30). A model with a QD connector requires an accessory mating cable. See [Quick-Disconnect Cables](#) on page 8 for more information.



WARNING: Not To Be Used for Personnel Protection

Never use this product as a sensing device for personnel protection. Doing so could lead to serious injury or death. This product does NOT include the self-checking redundant circuitry necessary to allow its use in personnel safety applications. A sensor failure or malfunction can cause either an energized or de-energized sensor output condition.

Overview

The T-GAGE analog sensor is a passive, non-contacting, temperature-based device. It is used to detect object(s) temperature within a sensing window and output a proportional voltage or current.

While it looks and operates just like an Expert™ photoelectric sensor, the T-GAGE detects the infrared light energy emitted by objects, instead of its own emitted light. The sensor uses a thermopile detector, made up of multiple infrared-sensitive elements (thermocouples) to detect this infrared energy within its field of view (see [Figure 2. Detection spot size versus distance from sensor](#) on page 2).

Potential applications include:

- Hot part detection (baked goods, metals, bottles, rubber)
- Ejection verification of injection-molded parts
- Flame process verification
- Hot glue detection (packaging equipment, book binding, product assembly)
- Cold part detection (frozen foods, ice, dairy)
- Roller monitoring

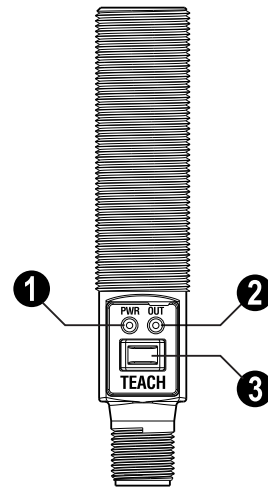

Figure 1. Sensor Features



NOTE: The T-GAGE M18T sensor is not intended for absolute temperature measurement or for safety-related fire detection use.

| | |
|---|-------------------|
| 1 | Power/Teach LED |
| 2 | Alarm Output LED |
| 3 | TEACH Push Button |

Sensing Field of View

The sensing range is determined by the sensor's field of view (FOV), or viewing angle, combined with the size of the object(s) being detected (see [Figure 2. Detection spot size versus distance from sensor](#) on page 2). The sensor's distance-to-spot size ratio (D:S ratio) is inversely related to the viewing angle; a sensor with a small viewing angle will have a large D:S ratio. The T-GAGE M18T sensors have D:S ratios of 6:1, 8:1 or 14:1. For a sensor with an 8:1 D:S ratio, the sensor's spot size is a 1" diameter circle at a distance of 8"; farther from the sensor face the spot size will be larger.

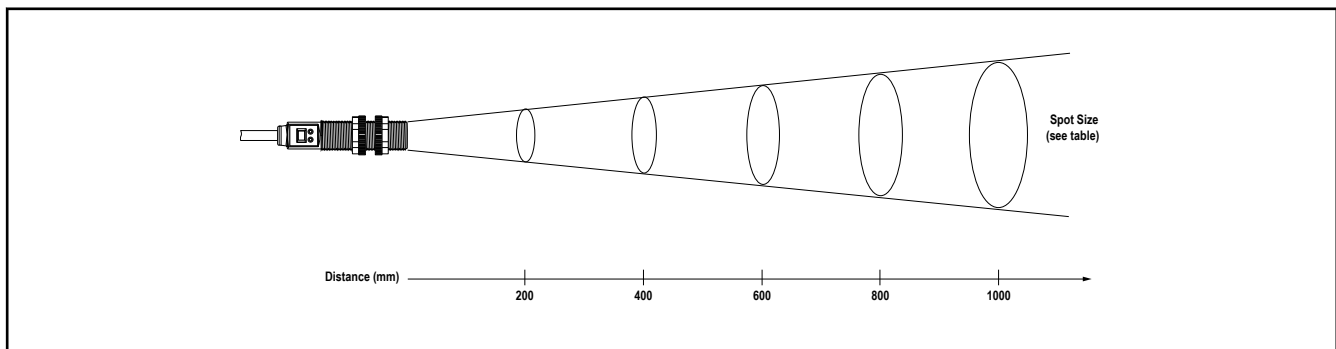

| Sensor D:S Ratio | Distance from Sensor Face Versus Spot Size | | | | | | | | | | Distance (mm) |
|------------------|--|-----|-----|-----|-----|-----|-----|-----|-----|------|----------------|
| | 100 | 200 | 300 | 400 | 500 | 600 | 700 | 800 | 900 | 1000 | |
| 6:1 | 17 | 33 | 50 | 67 | 83 | 100 | 117 | 133 | 150 | 167 | Spot Size (mm) |
| 8:1 | 13 | 25 | 38 | 50 | 63 | 75 | 88 | 100 | 113 | 125 | |
| 14:1 | 7 | 14 | 21 | 29 | 36 | 43 | 50 | 57 | 64 | 71 | |

Figure 2. Detection spot size versus distance from sensor

Apparent Temperature

Two factors that have a large influence on apparent temperature are the object's *emissivity* and whether or not the object fills the sensor's field of view.

Object Emissivity:

A "blackbody" is a "perfect" emitter, with an emissivity of 1.0 at all temperatures and wavelengths. Most surfaces emit only a fraction of the amount of thermal energy that a blackbody would. Typical T-GAGE applications will be sensing objects with emissivities ranging from 0.5 to 0.95. Many references are available with tables of emissivity coefficients for common materials. In general, shiny unpainted metals have low emissivity, while non-glossy surfaces have high emissivity.

Shiny surfaces: a mirror or shiny surface can redirect an object's emitted energy to an undesired location, or even bring additional unintended thermal energy into the sensor's field of view (see [Application Note](#) on page 6).

Object Size:

If the object being detected does not fill the sensor's field of view, then the sensor will average the temperature of that object and whatever else is in the sensing field of view. For the sensor to collect the maximum amount of energy, the object should completely fill the sensor's field of view. However, in some applications, when the object is too small, this may not be possible. In such cases, if the object is hot enough, the thermal contrast may still be adequate to trigger the sensor's output.

Alarm Output

The alarm output will activate when the analog output is at 10V or 20mA, depending on model (see [Figure 3. Analog/Alarm outputs as a function of taught conditions](#) on page 3).

Analog Output

The T-GAGE analog sensor can be programmed for either positive or negative output slope, based on the teach order (see [Figure 3. Analog/Alarm outputs as a function of taught conditions](#) on page 3). If the cold limit is taught first, the slope will be positive; if the hot limit is taught first, the slope will be negative. Banner's scalable output automatically distributes the output signal over the width of the programmed sensing window.

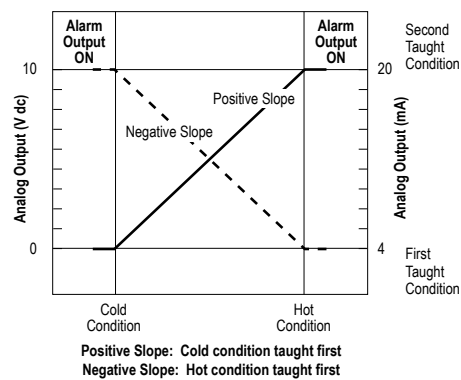

Figure 3. Analog/Alarm outputs as a function of taught conditions

Sensor Programming

Two TEACH methods may be used to program the sensor:

- Teach individual minimum and maximum limits (Two-Point Static Teach), or
- Dynamic Teach for on-the-fly programming.

The sensor may be programmed either via its push button, or via a remote switch. Remote programming also may be used to disable the push button, preventing unauthorized personnel from adjusting the programming settings. To access this feature, connect a normally open switch between the sensor's gray wire and dc common or connect the gray wire to a digital input (PLC).



NOTE: The impedance of the Remote Teach input is 3 kΩ.

Programming is accomplished by following the sequence of input pulses (see [Teaching Limits Using Two-Point Static TEACH](#) on page 4). The duration of each pulse (corresponding to a push button "click"), and the period between multiple pulses, are defined as "T":

$$0.04 \text{ seconds} < T < 0.8 \text{ seconds}$$

Status Indicators







| Power ON/OFF LED | Indicates | Alarm Output LED | Indicates |
|------------------|-----------------------|------------------|---|
| OFF | Power is OFF | OFF | Run Mode: Alarm output is OFF TEACH Mode: Waiting for Span condition |
| ON Green | Sensor is in Run mode | ON Yellow | Run Mode: Alarm output is energized TEACH Mode: Waiting for Null condition |
| ON Red | TEACH is active | Flashing Yellow | Dynamic TEACH active |

Teaching Limits Using Two-Point Static TEACH

Two-Point TEACH is the traditional setup method, used when two conditions can be presented individually by the user. The sensor establishes the Null (0V or 4mA) output condition with the first taught condition and the Span (10V or 20mA) output condition with the second taught condition, and it scales between these points.

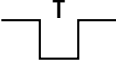
General Notes on Programming

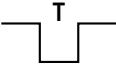

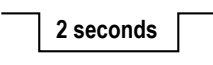
- The sensor will return to RUN mode if the first TEACH condition is not registered within 60 seconds
- After the first limit is taught, the sensor will remain in PROGRAM mode until the TEACH sequence is finished

| | Two-Point TEACH Procedure | | Result |
|----------------------|--|---|--|
| | Push Button | Remote Line <small>(0.04 sec < T < 0.8 sec)</small> | |
| Programming Mode | <ul style="list-style-type: none"> • Push and hold push button for 2 seconds  | No action required | <ul style="list-style-type: none"> • Power LED turns Red • Alarm LED turns ON |
| Learn Null Condition | <ul style="list-style-type: none"> • Present condition for Null output • "Click" the push button  | <ul style="list-style-type: none"> • Present condition for Null output • Single-pulse the remote line  | <ul style="list-style-type: none"> • Alarm LED turns OFF |
| Learn Span Condition | <ul style="list-style-type: none"> • Present condition for Span output • "Click" the push button  | <ul style="list-style-type: none"> • Present condition for Span output • Single-pulse the remote line  | <p>Teach Accepted</p> <ul style="list-style-type: none"> • Power LED turns Green • Sensor automatically sets the analog range and returns to Run mode <p>Teach Unacceptable Sensor returns to beginning of Teach</p> |
| Exit Without Save | <ul style="list-style-type: none"> • Push and hold push button for 2 seconds  | <ul style="list-style-type: none"> • Hold remote line low for 2 seconds  | Sensor returns to Run mode without saving new settings |

Teaching Limits Using Dynamic TEACH

Dynamic TEACH is a method of setting the sensor's limits while the application is active. Dynamic TEACH will sense the high and low temperature limits of the process and automatically set the analog range between these limits.

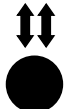
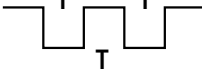
The output slope will remain in the direction of the most recently taught Two-Point Static TEACH or default to positive.

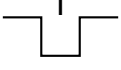
| | Dynamic TEACH Procedure | | Result |
|-----------------------------|---|--|---|
| | Push Button | Remote Line (0.04 sec < T < 0.8 sec) | |
| Programming Mode | <ul style="list-style-type: none"> Push and hold push button for 2 seconds  | No action required | <ul style="list-style-type: none"> Power LED turns Red Alarm LED turns OFF |
| Enter Dynamic TEACH Process | <ul style="list-style-type: none"> "Double-click" the push button  | <ul style="list-style-type: none"> Double-pulse the remote line  | <ul style="list-style-type: none"> Sensor begins dynamic learning process Alarm LED flashes Yellow @ 2 Hz |
| End Dynamic TEACH Process | <ul style="list-style-type: none"> "Single-click" the push button  | <ul style="list-style-type: none"> Single-pulse the remote line  | <ul style="list-style-type: none"> Sensor ends data collection; sets Null and Span limits Power LED turns Green Sensor returns to Run mode |

Changing Direction of Output Slope

The following procedure changes the direction of the analog output slope from negative to positive or from positive to negative. See [Analog Output](#) on page 3 for an explanation of the analog output slope.

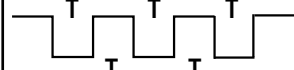
| | Procedure | | Result |
|-------------------------------|-------------------------------|---|---|
| | Push Button | Remote Line (0.04 sec < T < 0.8 sec) | |
| Change Output Slope Direction | Not available via push button | <ul style="list-style-type: none"> Three-pulse the remote line  | <ul style="list-style-type: none"> Output slope changes from negative to positive or from positive to negative |

Push Button Lockout

The push button lockout feature enables or disables the push button to prevent unauthorized adjustment of the program settings.

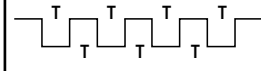
| | Procedure | | Result |
|---------------------|-------------------------------|--|--|
| | Push Button | Remote Line (0.04 sec < T < 0.8 sec) | |
| Push Button Lockout | Not available via push button | <ul style="list-style-type: none"> Four-pulse the remote line  | <ul style="list-style-type: none"> Push button is either enabled or disabled, depending on previous condition |

Installation Notes

Align the sensor toward the object to be detected. Visually align if possible, or use the alignment device accessory listed in [Additional Accessories](#) on page 9.

Specifications

Temperature Measurement Range

0° to 300° C (32° to 572° F) standard;
custom ranges available

Sensing Range

Depends on object size and sensing field of view (see [Sensing Field of View](#) on page 2)

Wavelength

8 to 14 μm

Distance to Spot Size (D:S) Ratio

6:1, 8:1, or 14:1, depending on model

Supply Voltage

12 to 30V dc (10% maximum ripple)
@ less than 35 mA (exclusive of load)

Output Configuration

Analog: 0-10V or 4-20 mA, depending on model
Alarm: PNP (current sourcing)

Output Protection

Protected against short circuit conditions

Output Ratings

Analog Voltage: 2.5 kΩ minimum load resistance
Analog Current: 1 kΩ max. @ 24V input; max. load resistance = $[(V_{cc} - 4)/0.02]\Omega$

For current output (4-20mA models): Ideal results are achieved when the total load resistance $R = [(V_{in} - 4)/0.02]\Omega$. **Example**, at $V_{in} = 24\text{ V dc}$, $R \approx 1\text{ k}\Omega$ (1 watt)

Alarm: Off-state leakage: < 10 microamps; **Saturation:** < 1.2 V @ 10 mA and < 1.6V @ 100 mA

Delay at Power-Up

1.5 seconds

Output Response Time

75 ms (for a 95% step change)

Repeatability

± 1% of measurement, or ± 1° C, whichever is greater

Minimum Taught Differential

10° C

Linearity

From 0° to 50° C: ±2°C

From 50° to 300° C: ±1°C or ±1%, whichever is greater

Adjustments

TEACH-Mode programming

Indicators

One bicolor (Green/Red) status LED, one Yellow LED (see [Status Indicators](#) on page 4)

Remote Teach Input

Impedance: 3 kΩ minimum load resistance

Construction

Threaded Barrel: 304 stainless steel

Push Button Housing: ABS/PC

Push Button: Santoprene

Lightpipes: Acrylic

Operating Conditions

Temperature: -20° to +70° C (-4° to 158° F)

Environmental Rating

Leakproof design is rated IEC IP67; NEMA 6

Temperature Warm-Up Time

5 minutes

Certifications

 for voltage models (M18TU..)

Current models (M18TI..) are pending CE

Application Note

Following are examples of materials with high and low emissivity. (Many more examples can be found in sources such as the Internet.)

Sensor-Friendly Materials (High Emissivity)

- Aluminum - anodized
- Asphalt
- Brick
- Carbon - lampblack or plate material
- Cardboard - corrugated or chipboard
- Concrete
- Glass - smooth, lead, or borosilicate (e.g., Pyrex®)
- Gypsum (including finished boards)
- Ice
- Iron and steel (except bright galvanized)
- Paper - most types, regardless of color
- Styrofoam® insulation
- Plastics
- Water
- Wood
- Rubber (e.g., tires)

Materials to Sense with Caution (Low Emissivity - Test, Test, Test!)

- Aluminum - plain or highly polished
- Copper
- Galvanized iron
- Stainless steel
- Vapor-deposited materials

Dimensions

Cabled Models

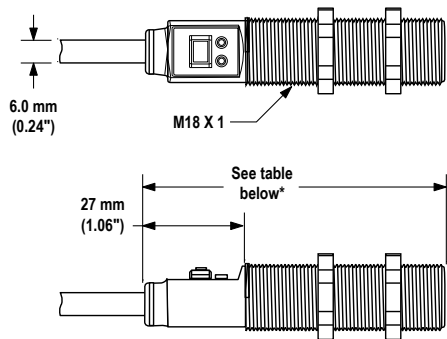

***Overall Length**

| | |
|----------------|-----------------|
| Model M18T..8 | 81.2 mm (3.20") |
| Model M18T..6E | 81.7 mm (3.22") |
| Model M18T..14 | 86.5 mm (3.41") |

QD Models

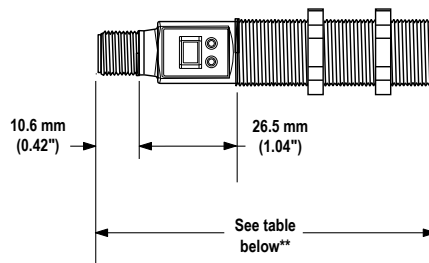

****Overall Length**

| | |
|-----------------|-----------------|
| Model M18T..8Q | 91.3 mm (3.59") |
| Model M18T..6EQ | 91.8 mm (3.61") |
| Model M18T..14Q | 96.6 mm (3.80") |

Hookups

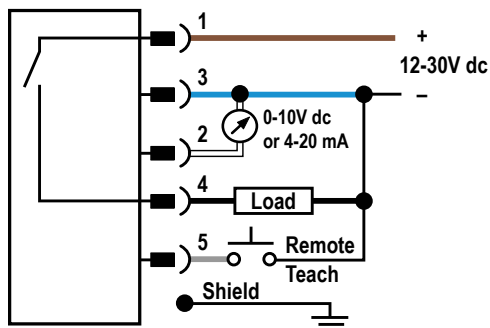

Cable and QD hookups are functionally identical.



NOTE: It is recommended that the shield wire be connected to earth ground or dc common. Shielded cord-sets are recommended for all QD models.

Accessories

Quick-Disconnect Cables

| Style | Model | Length | Dimensions | Pinout |
|---|--------------|------------|------------|--|
| 5-pin Euro-style straight, with shield | MQDEC2-506 | 2 m (6.5') | | <p>1 = Brown 2 = White 3 = Blue 4 = Black 5 = Gray</p> |
| | MQDEC2-515 | 5 m (15') | | |
| | MQDEC2-530 | 9 m (30') | | |
| 5-pin Euro-style right-angle, with shield | MQDEC2-506RA | 2 m (6.5') | | |
| | MQDEC2-515RA | 5 m (15') | | |
| | MQDEC2-530RA | 9 m (30') | | |

Accessory Mounting Brackets

| Model | Description | |
|----------------|---|--|
| SMB18A | <ul style="list-style-type: none"> • 12-gauge, stainless steel, right-angle mounting bracket with a curved mounting slot for versatility and orientation • Clearance for M4 (#8) hardware | |
| SMB18SF | <ul style="list-style-type: none"> • 18 mm swivel bracket • Black thermoplastic polyester • Includes stainless steel hardware | |
| SMB18UR | <ul style="list-style-type: none"> • 2-piece universal 18 mm swivel bracket • 300 series stainless steel • Includes stainless steel swivel locking hardware | |

Additional Accessories

Air-Purge Collar APC-18

- Positive air pressure prevents water, dust, and other air-borne contaminants from collecting on the sensor face.
- Air flow helps cool sensors affected by ambient heat in the sensing environment.
- Works with many of Banner's 18 mm threaded-barrel photoelectric and temperature sensors.

Note: Because air temperature affects the speed of sound, the Collar should not be used with ultrasonic sensors.

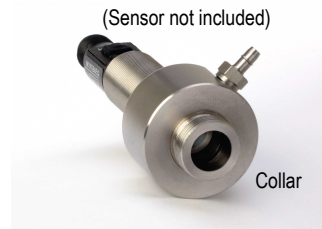

Laser Alignment Tool LAT1812

- Enables easy sensor alignment at long distances.
- Kit includes one SMB1812 bracket and M12 laser emitter.
- Thread bracket housing onto barrel of mounted sensor; M12 laser emitter inserted into housing provides a precise laser spot for aiming temperature sensor. (Refer to Banner data sheet p/n 122529 for more information.)
- Remove laser emitter before using sensor.



Banner Engineering Corp Limited Warranty

Banner Engineering Corp. warrants its products to be free from defects in material and workmanship for one year following the date of shipment. Banner Engineering Corp. will repair or replace, free of charge, any product of its manufacture which, at the time it is returned to the factory, is found to have been defective during the warranty period. This warranty does not cover damage or liability for misuse, abuse, or the improper application or installation of the Banner product.

THIS LIMITED WARRANTY IS EXCLUSIVE AND IN LIEU OF ALL OTHER WARRANTIES WHETHER EXPRESS OR IMPLIED (INCLUDING, WITHOUT LIMITATION, ANY WARRANTY OF MERCHANTABILITY OR FITNESS FOR A PARTICULAR PURPOSE), AND WHETHER ARISING UNDER COURSE OF PERFORMANCE, COURSE OF DEALING OR TRADE USAGE.

This Warranty is exclusive and limited to repair or, at the discretion of Banner Engineering Corp., replacement. **IN NO EVENT SHALL BANNER ENGINEERING CORP. BE LIABLE TO BUYER OR ANY OTHER PERSON OR ENTITY FOR ANY EXTRA COSTS, EXPENSES, LOSSES, LOSS OF PROFITS, OR ANY INCIDENTAL, CONSEQUENTIAL OR SPECIAL DAMAGES RESULTING FROM ANY PRODUCT DEFECT OR FROM THE USE OR INABILITY TO USE THE PRODUCT, WHETHER ARISING IN CONTRACT OR WARRANTY, STATUTE, TORT, STRICT LIABILITY, NEGLIGENCE, OR OTHERWISE.**

Banner Engineering Corp. reserves the right to change, modify or improve the design of the product without assuming any obligations or liabilities relating to any product previously manufactured by Banner Engineering Corp.