

# SSA-EB Series Emergency Stop Push Buttons

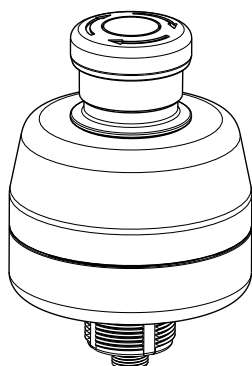

Illuminated Safety BUS Gateway Compatible 30mm Mount Electro-Mechanical Push Buttons

## Features



- Designed to interface with Safety BUS nodes/gateways
- Rugged design; easy installation with no assembly or individual wiring required
- Push-to-stop, twist-to-release, or pull-to-release operation per IEC60947-5-5
- Latching design complies with ISO 13850; direct (positive) opening operation per IEC 60947-5-1
- Compliant with ANSI B11.19, ANSI NFPA79, and IEC/EN 60204-1 Emergency Stop requirements
- "Safe Break Action" ensures N.C. contacts will open if the contact block is separated from the actuator
- 5-pin M12/Euro-style Quick Disconnect
- Models with YELLOW and RED indication of actuation (armed or depressed/latched button)
- "Emergency Stop" legend included

Models SSA-EB... series are "mushroom-style" electro-mechanical emergency stop push buttons. When the button is armed, the switch's safety contacts (N.C.) are closed and its monitoring contacts (N.O.), if present, are open. When the button is pushed, the switch's safety contacts open and the monitoring contacts close. The contacts remain in this condition until the push button is manually rearmed by twisting clockwise the red push button actuator.

The SSA-EB1P...-02ECQ5.. series has a 30 mm mounting base similar to Banner's OTB, VTB, and STB Optical Touch Buttons for ease of mounting without requiring an additional enclosure. The illuminated models provide indication of an armed button and a pushed/actuated button (indication is dependent on model). The red indication allows for easy identification of a pushed/actuated button.

## Models

| Model               | Hookup | EZ-LIGHT™ Illumination Logic and Description          | Compatibility |
|---------------------|--------|---|---------------|
| SSA-EB1PL-02ECQ5A   | A      | OFF (armed), RED (solid, PUSH)                        | AB/ROCKWELL®  |
| SSA-EB1PL-02ECQ5B   | B      | OFF (armed), RED (solid, PUSH)                        | Siemens       |
| SSA-EB1PLXR-02ECQ5A | A      | OFF (armed), RED only (flash, PUSH)                   | AB/ROCKWELL®  |
| SSA-EB1PLXR-02ECQ5B | B      | OFF (armed), RED only (flash, PUSH)                   | Siemens       |
| SSA-EB1PLYR-02ECQ5A | A      | YELLOW (armed) & RED (flashing, PUSH)                 | AB/ROCKWELL®  |
| SSA-EB1PLYR-02ECQ5B | B      | YELLOW (armed) & RED (flashing, PUSH)                 | Siemens       |
| SSA-EB1PL2-02ECQ5A  | A      | Illuminated button, OFF (armed), RED (solid, PUSH ON) | AB/ROCKWELL®  |
| SSA-EB1PL2-02ECQ5B  | B      | Illuminated button, OFF (armed), RED (solid, PUSH ON) | Siemens       |

Additional models available. For non-illuminated models, see <http://www.bannerengineering.com> and search 162755\_web.

## Important... Read this before proceeding!

**The user is responsible for satisfying all local, state, and national laws**, rules, codes, and regulations relating to the use of this product and its application. Banner Engineering Corp. has made every effort to provide complete application, installation, operation, and maintenance instructions. Please direct any questions regarding the use or installation of this product to the factory applications department at the telephone numbers or address found at <http://www.bannerengineering.com>.

**The user is responsible** for making sure that all machine operators, maintenance personnel, electricians, and supervisors are thoroughly familiar with and understand all instructions regarding the installation, maintenance, and use of this product, and with the machinery it controls. The user and any personnel involved with the installation and use of this product must be thoroughly familiar with all applicable standards, some of which are listed within the specifications. Banner Engineering Corp. makes no claim regarding a specific recommen-

dition of any organization, the accuracy or effectiveness of any information provided, or the appropriateness of the provided information for a specific application.



**WARNING: Not a Safeguarding Device**

**An Emergency Stop Device is not considered a safeguarding device because it requires an overt action by an individual to stop machine motion or hazards.**

(A safeguarding device limits or eliminates an individual's exposure to a hazard *without action by the individual or others.*) Because an individual must actuate the device for it to function, these devices do not fit the definition of a safeguarding device and cannot be substituted for required safeguarding. Refer to the relevant standards to determine those requirements.

## Emergency Stop Considerations

ANSI NFPA 79, ANSI B11.19, IEC/EN 60204-1, and ISO 13850 specify emergency stop requirements, including the following:

- Emergency-stop push buttons shall be located at each operator control station and at other operating stations where emergency shutdown is required.
- Stop and emergency-stop push buttons shall be continuously operable and readily accessible from all control and operating stations where located. Do not mute or bypass E-stop buttons.
- Actuators of emergency-stop devices shall be colored red. The background immediately around the device actuator shall be colored yellow (where possible). The actuator of a push-button-operated device shall be of the palm or mushroom-head type.
- The emergency-stop actuator shall be a self-latching type.



**WARNING: Emergency Stop Functions**

**Do not mute or bypass any Emergency Stop device.** ANSI B11.19, ANSI NFPA79 and IEC/EN 60204-1 require that **the Emergency Stop function remain active at all times.**



**WARNING: Multiple Switching Devices**

**Whenever two or more devices are connected to the same safety module (controller):**

- **Contacts of the corresponding pole of each switch must be connected together in series. Never connect the contacts of multiple switches in parallel.** Such a parallel connection defeats the switch contact monitoring ability of the Module and creates an unsafe condition which could result in serious injury or death.
- **Each device must be individually actuated (engaged), then released (or re-armed) and the safety module reset.** This allows the module to check each switch and its wiring to detect faults.

This check must be performed during the prescribed checkouts. **Failure to test each device individually in this manner could result in undetected faults and create an unsafe condition which could result in serious injury or death.**

## Installation and Maintenance

The device must not be affected by environmental conditions. **Install the device so that operation is not impeded, but should be protected against inadvertent operation** (for example, accidental actuation by being bumped or leaned against). Do not operate the switch using a tool. Do not expose the switch to excessive shocks and vibrations, otherwise the switch may be deformed or damaged, causing malfunction or operation failure. Hardware includes jam nut, lock washer, lock ring, and seal washer. The lock ring may be used to prevent switch rotation if a 5mm hole keyway is provided.

Electrical installation must be made by qualified personnel and must comply with NEC (National Electrical Code), ANSI/NFPA 79 or IEC/EN 60204-1, and all applicable local standards. It is not possible to give exact wiring instructions for a device that interfaces to a multitude of machine control configurations. The following is general in nature; it is recommended to perform a risk assessment to ensure appropriate application, interfacing/hookup, and risk reduction (see ISO 12100 or ANSI B11.0).

Table 1: SSA-EB1PLxx-02ECQ5A <sup>1</sup> and SSA-EB1PLxx-02ECQ5B <sup>2</sup>

| Pin            | Color | -02ED1Q5A |          | -02ED1Q5B |          | Pinout |
|----------------|-------|-----------|----------|-----------|----------|--------|
|                |       | Function  | Contacts | Function  | Contacts |        |
| 1 <sup>3</sup> | Brown | CH1a      | N.C.     | CH1b      | N.C.     |        |
| 2              | White | CH1b      | N.C.     | CH2a      | N.C.     |        |
| 3              | Blue  | 0V dc     |          | 0V dc     |          |        |
| 4              | Black | CH2a      | N.C.     | CH1a      | N.C.     |        |
| 5              | Gray  | CH2b      | N.C.     | CH2b      | N.C.     |        |

**WARNING: Shock Hazard and Hazardous Energy**

Always disconnect power from the safety system (for example, device, module, interfacing, etc.) and the machine being controlled before making any connections or replacing any component.

Electrical installation and wiring must be made by Qualified Personnel and must comply with the relevant electrical standards and wiring codes, such as the NEC (National Electrical Code), ANSI NFPA79, or IEC 60204-1, and all applicable local standards and codes.

**Lockout/tagout procedures may be required.** Refer to OSHA 29CFR1910.147, ANSI Z244-1, or the appropriate standard for controlling hazardous energy.

## Specifications

### Housing / Button

Polycarbonate / Polyamide  
Threaded base has M30 x 1.5 external threads; Max.  
Tightening Torque: 4.5 N·m (40 in·lbf)

### Operating Conditions

**Temperature:** -25° to +55° C (-13° to +131° F)  
**Humidity:** 45% to 85% RH (no condensation)

### Environmental Rating

IP65 (IEC60529)

### Insulation Resistance

100MΩ minimum (500V DC megger)

### Impulse Withstand Voltage

2.5kV

### Pollution Degree

3

### Output Configuration

See [Installation and Maintenance](#) on page 2

### Overvoltage Category

II

### Vibration Resistance

**Operating extremes:** 10 to 500Hz, amplitude 0.35 mm  
acceleration 50 m/s<sup>2</sup>

### Illuminated Base

**LED Color:** Yellow - 590 nm, Red - 618 nm  
**LED Flash Rate:** 1.6 Hz at 50% duty cycle  
**LED Voltage/Current:** 12 to 30 V dc; 120 mA at 12V dc, 65 mA at 24Vdc, 60 mA at 30V dc

### Illuminated Button

**LED Color:** Red  
**LED Voltage/Current:** 24V ac/dc ±10%; 15mA

### Electrical Rating

**Minimum load:** 1 mA at 5V ac/dc  
**SSA-EB1PLxx-.Q5:** 3A at 250V maximum  
**UL Applications:** 1.5A at 250V ac, 1A at 30V dc (pilot duty)  
**CE Applications:** AC-15: 1.5A at 250V ac, DC-13: 1A at 30V dc

### Rated Insulation Voltage (Ui)

250V

### Rated Current (Ith)

3A

<sup>1</sup> Compatible with AllenBradley ArmorBlock® 1732DS Safe DeviceNet remote I/O.

<sup>2</sup> Compatible with Siemens ET 200pro PROFIsafe gateway.

<sup>3</sup> Pin 1 on all models requires power from the node/gateway for the EZ-LIGHT™ illumination logic (see LED Voltage/Current specifications). User must verify interconnection compatibility.

**Contact Material/Bounce<sup>4</sup>**

Gold plated silver / 20 ms

**Electrical Life**

100,000 operations minimum, 250,000 operations minimum at 24V AC/DC, 100mA

**Mechanical Life**

250,000 operations

**Shock Resistance****Operating extremes:** 150 m/s<sup>2</sup> (15G)**B10d**

100,000 (based on ISO13849-1(2006))

**Design and Application Standards**

Compliant with EN/IEC 60497-1 / -5-1, ISO 13850, ANSI B11.19 , ANSI NFPA79, IEC 60204-1

**Date code format (U.S. Standard Format)****YYWWX:** 2-digit year, 2-digit week, "X" internal code**Certifications**

Other approvals pending

**Rated Operating Current and Voltage (Ue)**

| Safety Contact (N.C.) |                        | 30V | 125V  | 250V |
|-----------------------|------------------------|-----|-------|------|
| AC 50/60 Hz           | Resistive Load (AC-12) | -   | -     | 3A   |
|                       | Inductive Load (AC-15) | -   | 3A    | 1.5A |
| DC                    | Resistive Load (DC-12) | 2A  | 0.4A  | 0.2A |
|                       | Inductive Load (DC-13) | 1A  | 0.22A | 0.1A |

The operating current is classified according to JIS C 8201-5-1-1999 making and breaking capacities and are measured at resistive/inductive load types specified in IEC 60947-5-1. See "Electrical Rating" above for specific model and UL/CE maximum ratings.

**Checkout**

At machine set up, a *Designated Person*<sup>5</sup> should test each emergency stop push button for proper machine shutdown response. A *Designated Person* should check the emergency stop buttons for proper operation, physical damage, button looseness, and excessive environmental contamination. This should take place on a periodic schedule determined by the user, based on the severity of the operating environment and the frequency of switch actuations. Adjust, repair, or replace components as needed. If inspection reveals contamination on the switch, thoroughly clean the switch and eliminate the cause of the contamination. Replace the switch and/or appropriate components when any parts or assemblies are damaged, broken, deformed, or badly worn; or if the electrical/mechanical specifications (for the environment and operating conditions) have been exceeded. **Always test the control system for proper functioning** under machine control conditions after performing maintenance, replacing the emergency stop device, or replacing any component of the device.

<sup>4</sup> When the button is reset, the normally closed contacts will chatter. When pressing the button, the normally open contacts will chatter. When designing a control circuit, take the contact chatter time into consideration. Do not expose the switch to external shocks, otherwise the contacts will bounce.

<sup>5</sup> A *Designated Person* is identified in writing by the employer as being appropriately trained to perform a specified checkout procedure. A Qualified Person possesses a recognized degree or certificate or has extensive knowledge, training, and experience to solve problems relating to the emergency stop installation.

## Dimensions

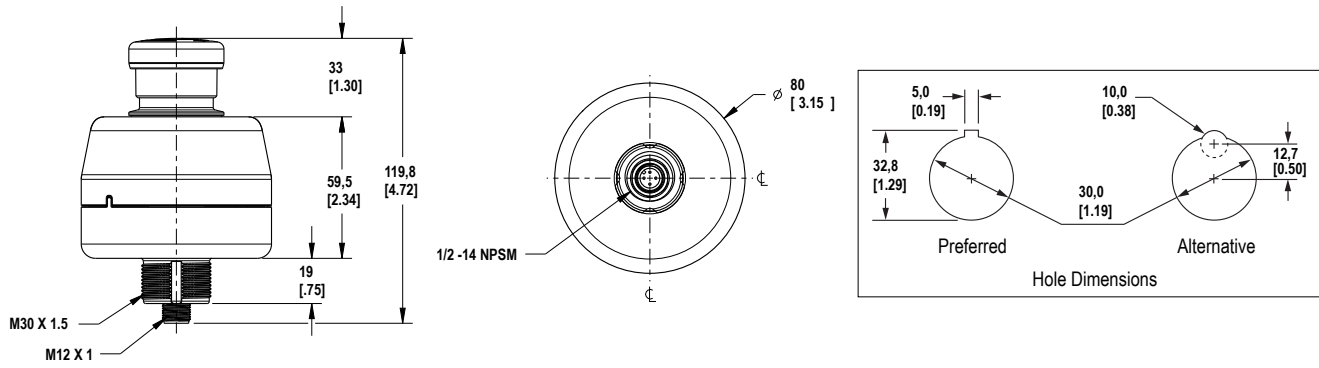

## Accessories

### Mounting Brackets

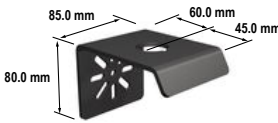
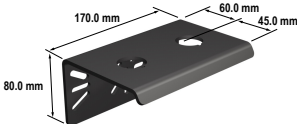
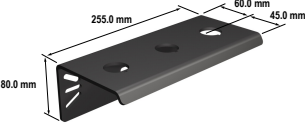
| Model        |                   | Dimensions  | Description   |
|--------------|-------------------|---|---|
| SSA-MBK-EEC1 | Single 30 mm hole |   | <ul style="list-style-type: none"> <li>• Allows for horizontal and vertical (post) mounting</li> <li>• The position of mounted devices (e.g. OTB/STB/VTB, E-Stop, K50's) are interchangeable</li> <li>• 8 gauge steel, black finish (zinc-plated)</li> <li>• Front surface for customer applied labels</li> </ul> |
| SSA-MBK-EEC2 | Two 30 mm holes   |  |   |
| SSA-MBK-EEC3 | Three 30 mm holes |  |   |

## Cordsets

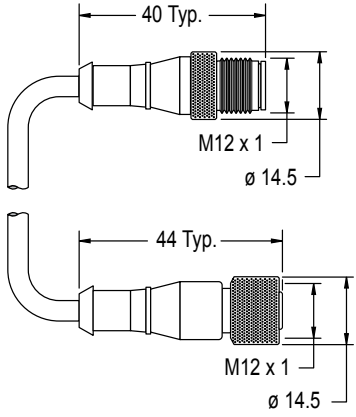
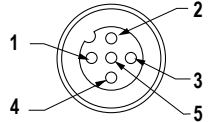
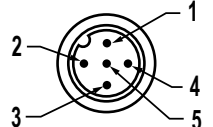
| 5-Pin Threaded M12/Euro-Style Cordsets—Double Ended |        |                                   |  |  |
|---|--------|-----------------------------------|--|--|
| Model   | Length | Style                             | Dimensions   | Pinout   |
| DEE2R-51D   | 0.31 m | Female Straight/<br>Male Straight |  | <b>Female</b><br> |
| DEE2R-53D   | 0.91 m |                                   |  | <b>Male</b><br>   |
| DEE2R-58D   | 2.44 m |                                   |  | 1 = Brown<br>2 = White<br>3 = Blue<br>4 = Black<br>5 = Green/Yellow                                  |
| DEE2R-515D  | 4.57 m |                                   |  |  |
| DEE2R-525D  | 7.62 m |                                   |  |  |
| DEE2R-550D  | 15.2 m |                                   |  |  |
| DEE2R-575D  | 22.9 m |                                   |  |  |
| DEE2R-5100D   | 30.5 m |                                   |  |  |

See Banner Engineering catalog or <http://www.bannerengineering.com> for additional models and complete information.

## U.S. Application Standards

ANSI B11.0 Safety of Machinery; General Requirements and Risk Assessment

ANSI B11.19 Performance Criteria for Safeguarding

ANSI NFPA 79 Electrical Standard for Industrial Machinery

## International/European Standards

ISO 12100 Safety of Machinery – General Principles for Design — Risk Assessment and Risk Reduction

ISO 13850 (EN 418) Emergency Stop Devices, Functional Aspects – Principles for Design

IEC 62061 Functional Safety of Safety-Related Electrical, Electronic and Programmable Control Systems

ISO 13849-1 (EN 954-1) Safety-Related Parts of Control Systems

IEC 60204-1 Electrical Equipment of Machines Part 1: General Requirements

IEC 60947-1 Low Voltage Switchgear – General Rules

IEC 60947-5-1 Low Voltage Switchgear – Electromechanical Control Circuit Devices

IEC 60947-5-5 Low Voltage Switchgear – Electrical Emergency Stop Device with Mechanical Latching Function

## EC Declaration of Conformity (DOC)

Banner Engineering Corp. herewith declares that the **SSA-EB1.. Emergency Stop Push Buttons** are in conformity with the provisions of the Machinery Directive and all essential health and safety requirements have been met. For more information, visit <http://www.bannerengineering.com/>.

## Banner Engineering Corp Limited Warranty

Banner Engineering Corp. warrants its products to be free from defects in material and workmanship for one year following the date of shipment. Banner Engineering Corp. will repair or replace, free of charge, any product of its manufacture which, at the time it is returned to the factory, is found to have been defective during the warranty period. This warranty does not cover damage or liability for misuse, abuse, or the improper application or installation of the Banner product.

**THIS LIMITED WARRANTY IS EXCLUSIVE AND IN LIEU OF ALL OTHER WARRANTIES WHETHER EXPRESS OR IMPLIED (INCLUDING, WITHOUT LIMITATION, ANY WARRANTY OF MERCHANTABILITY OR FITNESS FOR A PARTICULAR PURPOSE), AND WHETHER ARISING UNDER COURSE OF PERFORMANCE, COURSE OF DEALING OR TRADE USAGE.**

This Warranty is exclusive and limited to repair or, at the discretion of Banner Engineering Corp., replacement. **IN NO EVENT SHALL BANNER ENGINEERING CORP. BE LIABLE TO BUYER OR ANY OTHER PERSON OR ENTITY FOR ANY EXTRA COSTS, EXPENSES, LOSSES, LOSS OF PROFITS, OR ANY INCIDENTAL, CONSEQUENTIAL OR SPECIAL DAMAGES RESULTING FROM ANY PRODUCT DEFECT OR FROM THE USE OR INABILITY TO USE THE PRODUCT, WHETHER ARISING IN CONTRACT OR WARRANTY, STATUTE, TORT, STRICT LIABILITY, NEGLIGENCE, OR OTHERWISE.**

Banner Engineering Corp. reserves the right to change, modify or improve the design of the product without assuming any obligations or liabilities relating to any product previously manufactured by Banner Engineering Corp.