



MINI-BEAM® SM312FV

Visible-light Glass Fiber Optic DC Sensors



- Used with Banner Glass Fiber Optic assemblies for specific applications including the following: color registration sensing in the diffuse mode (except for red-on-white contrast, which requires a green or blue light source); presence sensing of translucent materials and registration mark sensing on clear webs in the opposed mode
- Compact, modulated, self-contained fiber optic sensors for 10-30V dc operation
- Useable in opposed, retroreflective, and diffuse fiber optic modes with Banner glass fiber optic assemblies
- Switch-selectable for light operate or dark operate
- Includes Banner's *exclusive* AID™ alignment system; US patent number 4356393



Visible red, 650 nm

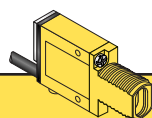

MINI-BEAM Glass Fiber Optic Models

Models	Range	Cable*	Supply Voltage	Output Type	Excess Gain	Beam Pattern
					Diffuse mode performance based on 90% reflectance white test card	
SM312FV SM312FVQD	Range varies by sensing mode and fiber optics used	2 m (6.5') 4-Pin Euro QD	10-30V dc	Bipolar NPN/PNP		

***NOTES:**

- 9 m (30') cables are available by adding suffix "W/30" to the model number of any cabled sensor (e.g., **SM312FV W/30**).
- A 150 mm (6") long pigtail cable with attached QD connector is available by adding suffix "QDP" to the model number of any MINI-BEAM sensor (e.g., **SM312FVQDP**). See page 5 for more information.
- A model with a QD connector requires an accessory mating cable. See page 5 for more information.
- May be ordered with 0.3 millisecond on/off response by adding suffix "MHS" to the model numbers (e.g., **SM312FVMHS**). This modification reduces sensing range (and excess gain).

MINI-BEAM Features

*** Note regarding Light/Dark operate switch:**

- Turn switch *fully* clockwise for light operate (sensor outputs conduct when sensing light is received)
- Turn switch *fully* counterclockwise for dark operate (sensor outputs conduct when sensing light is not received)

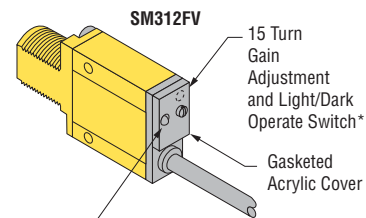

"AID" Indicator LED lights when the sensor sees its own modulated light and pulses at a rate proportional to the strength of the received light signal.

MINI-BEAM Fiber Information

- 1) Install the O-ring (supplied with the fiber) on each fiber end, as shown in the drawing.
- 2) While pressing the fiber ends firmly into the ports on the front of the sensor, slide the U-shaped retaining clip (supplied with the sensor) into the slot in the sensor's barrel, until it snaps into place.

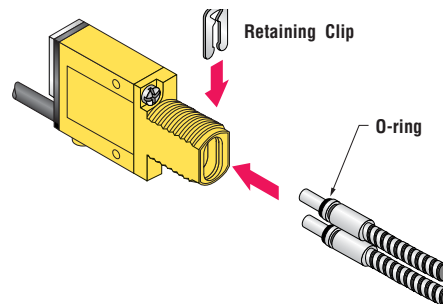

Lens Attachment

Lenses are sometimes added to fiber optic assemblies for extending opposed mode sensing range. Banner offers the following lens assemblies for use with fiber optic assemblies which have 5/16" -24 threaded sensing tips (e.g. fiber model IT23S):

Model	Lens Size	Focal Length	Housing	Notes
L9	12.5 mm (1/2")	12.5 mm (1/2")	Aluminum	Suitable for all but highly corrosive environments
L16F	25 mm (1")	44 mm (1.7")	Delrin	Maximum operating temperature is 100° C (212° F)
L16FAL	25 mm (1")	44 mm (1.7")	Aluminum	Suitable for all but highly corrosive environments
L16FSS	25 mm (1")	44 mm (1.7")	Stainless Steel	Suitable for all environments

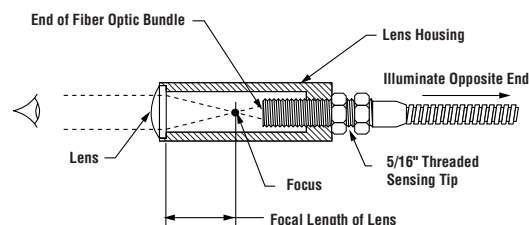

Lenses are most efficient when they are located slightly beyond their focal length distance from the sensing end of the fiber optic bundle. The easiest way to focus a lens is to treat it like a magnifying glass.

Illuminate the fiber optic bundle at the threaded end of the fiber optic assembly by directing the opposite end toward a visible light source (e.g., an incandescent bulb, visible LED, sunlight, etc.). Thread the lens onto the fiber optic assembly until the end of the fiber optic bundle comes into sharp focus under the lens. Then, back off (unthread) the lens assembly from the point of sharpest focus by one to three full turns. The illuminated bundle should now appear slightly blurred. This is the optimum setting, and the lens may be secured in position using one of the jam nuts provided. Refer to the drawing above.

MINI-BEAM DC Sensor Specifications	
Supply Voltage and Current	10 to 30V dc (10% maximum ripple) at less than 25 mA (exclusive of load)
Supply Protection Circuitry	Protected against reverse polarity and transient voltages
Output Configuration	Bipolar: One current sourcing (PNP) and one current sinking (NPN) open-collector transistor
Output Rating	150mA maximum each output at 25°C, derated to 100 mA at 70°C (derate ≈1 mA per °C) Off-state leakage current less than 1 microamp Output saturation voltage (PNP output) less than 1 volt at 10 mA and less than 2 volts at 150 mA Output saturation voltage (NPN output) less than 200 millivolts at 10 mA and less than 1 volt at 150 mA
Output Protection Circuitry	Protected against false pulse on power-up and continuous overload or short-circuit of outputs
Output Response Time	Sensors will respond to either a “light” or a “dark” signal of 1 millisecond or longer duration, 500 Hz max. 0.3 millisecond response modification is available. See note below. 100 millisecond delay on power-up: outputs do not conduct during this time. NOTE: DC MINI-BEAMs may be ordered with 0.3 millisecond on/off response by adding suffix “MHS” to the model numbers (e.g., SM312FVMHS). This modification reduces sensing range (and excess gain).
Repeatability	0.3 milliseconds. Response time and repeatability specifications are independent of signal strength.
Adjustments	LIGHT/DARK OPERATE select switch, and 15-turn slotted brass screw GAIN (sensitivity) adjustment potentiometer (clutched at both ends of travel). Both controls are located on rear panel of sensor and protected by a gasketed, clear acrylic cover.
Indicators	Exclusive, patented Alignment Indicating Device system (AID™, US patent #4356393) lights a rear-panel mounted red LED indicator whenever the sensor sees a “light” condition, with a superimposed pulse rate proportional to the light signal strength (the stronger the signal, the faster the pulse rate).
Construction	Reinforced PBT thermoplastic polyester housing, totally encapsulated, o-ring sealing, acrylic lenses, and stainless steel screws.
Environmental Rating	Meets NEMA standards 1, 2, 3, 3S, 4, 4X, 6, 12, and 13; IEC IP67
Connections	PVC-jacketed 4-conductor 2 m (6.5') or 9 m (30') cables, or 4-pin Euro-style quick disconnect (QD) fitting are available. QD cables are ordered separately. See page 5.
Operating Temperature	Temperature: -20° to +70°C (-4° to +158°F) Maximum relative humidity: 90% at 50°C (non-condensing)
Application Notes	The NPN (current sinking) output of dc MINI-BEAM sensors is directly compatible as an input to Banner logic modules, including all non-amplified MAXI-AMP and MICRO-AMP modules. MINI-BEAMs are TTL compatible.
Certifications	

MINI-BEAM DC Hookup Diagrams

DC Sensors with Attached Cable

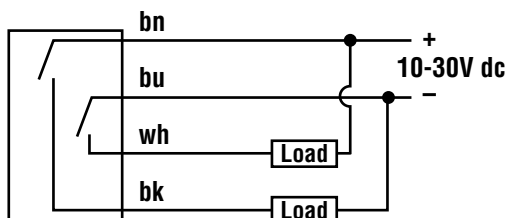

DC Sensors with Quick Disconnect (4-Pin Euro-Style)

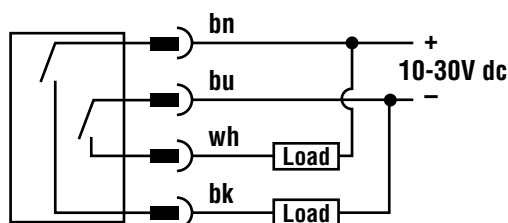

4-Pin Euro-Style Pin-out (Cable Connector Shown)

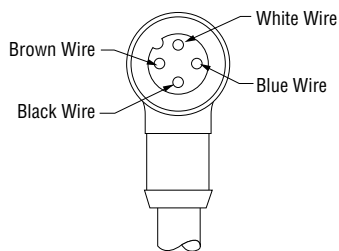

Quick Disconnect (QD) Option

DC MINI-BEAM sensors are sold with either a 2 m (6.5') or a 9 m (30') attached PVC-covered cable, or with a 4-pin Euro-style QD cable fitting.

DC QD sensors are identified by the letters "QD" in their model number suffix. For more information on mating QD cables, see page 5.

MINI-BEAM Dimensions

MINI-BEAM DC Sensor with Integral Cable

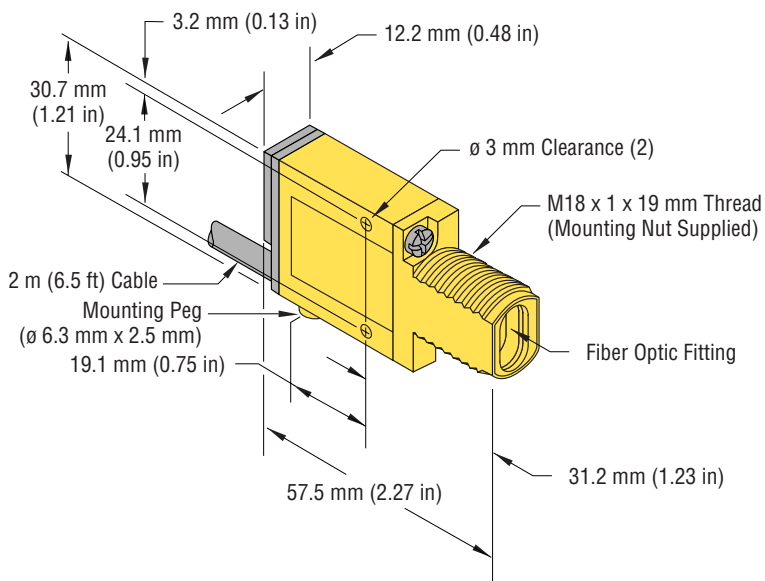

MINI-BEAM DC Sensor with Quick-Disconnect

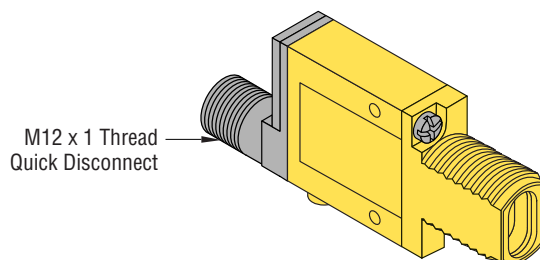





MINI-BEAM Modifications			
Model Suffix	Modification	Description	Example of Model Number
W/30	9 meter (30') cable	All MINI-BEAM sensors may be ordered with an integral 9 m (30') cable in place of the standard 2 m (6.5') cable	SM312FV W/30
MHS	Modified for High Speed	Standard dc MINI-BEAM sensors with 1 millisecond output response may be modified for 0.3 millisecond (300 μs) response. NOTE: Faster response comes at the expense of lower excess gain. Also, operating temperature range becomes -20° to +50°C (-4° to +122°F)	SM312FVMHS
QDP	Pigtail Quick Disconnect	All MINI-BEAMS may be built with a 150 mm (6") long integral cable which is terminated with the appropriate QD connector.	SM312FVQDP

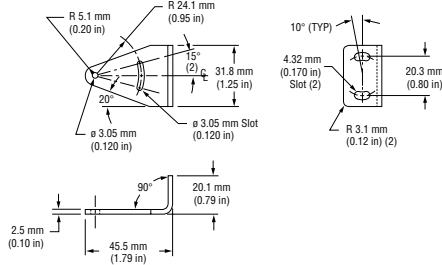

Extension Cables (without connectors)		
The following cables are available for extending the length of existing sensor cable. These are 30 m (100') lengths of MINI-BEAM cable. This cable may be spliced to existing cable. Connectors, if used, must be customer-supplied.		
Model	Type	Used with:
EC312-100	4-conductor	All MINI-BEAM SM312 dc models

Euro-Style Quick-Disconnect Cables				
<p>Cable: PVC jacket, polyurethane connector body, chrome-plated brass coupling nut</p> <p>Conductors: 22 or 20 AWG high-flex stranded, PVC insulation, gold-plated contacts</p> <p>Temperature: -40° to +90°C (-40° to +194°F)</p> <p>Voltage Rating: 250V ac/300V dc</p>				
Style	Model	Length	Dimensions:	Pin-out
4-Pin Straight	MQDC-406 MQDC-415 MQDC-430	2 m (6.5') 5 m (15') 9 m (30')		
4-Pin Right-angle	MQDC-406RA MQDC-415RA MQDC-430RA	2 m (6.5') 5 m (15') 9 m (30')		

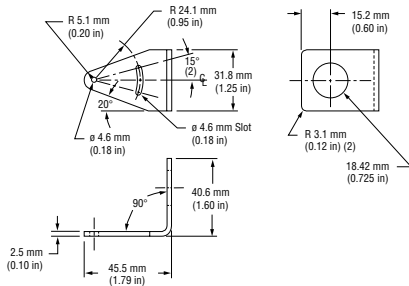
Mounting Brackets

Model	Description	
SMB312S	Stainless steel 2-axis, side mounting bracket	
SMB312PD	Stainless steel 18 mm barrel-mounting bracket	
SMB312B	Stainless steel 2-axis, bottom mounting bracket	
SMB46L	<ul style="list-style-type: none"> • “L” bracket • 14 ga 316 stainless steel 	

Mounting Brackets			
Model	Description	Dimensions	
SMB46S	<ul style="list-style-type: none"> • “S” bracket • 14 ga 316 stainless steel 		
SMB46U	<ul style="list-style-type: none"> • “U” bracket • 14 ga 316 stainless steel 		
SMB18C	<ul style="list-style-type: none"> • 18 mm split clamp black thermoplastic polyester bracket • Stainless steel mounting hardware included 		
SMB18SF	<ul style="list-style-type: none"> • 18 mm swivel bracket • Black thermoplastic polyester • Includes stainless steel swivel locking hardware 		

MINI-BEAM® Sensors SM312FV

Mounting Brackets

Model	Description	Diagram	Image
SMB3018SC	<ul style="list-style-type: none"> • 18 mm swivel barrel or side mount bracket • Black reinforced thermoplastic polyester • Includes stainless steel swivel locking hardware 		
SMB30SUS	<ul style="list-style-type: none"> • Side mount swivel bracket – extended range of motion • Black reinforced thermoplastic polyester • Includes stainless steel swivel locking hardware 		
SMB30SK	<ul style="list-style-type: none"> • Flat-mount swivel bracket with extended range of motion • Black reinforced thermoplastic polyester and 316 stainless steel • Includes stainless steel swivel locking hardware 		



WARNING . . . Not To Be Used for Personnel Protection

Never use this product as a sensing device for personnel protection. Doing so could lead to serious injury or death.

This product does NOT include the self-checking redundant circuitry necessary to allow its use in personnel safety applications. A sensor failure or malfunction can cause either an energized or de-energized sensor output condition. Consult your current Banner Safety Products catalog for safety products which meet OSHA, ANSI and IEC standards for personnel protection.

WARRANTY: Banner Engineering Corp. warrants its products to be free from defects for one year. Banner Engineering Corp. will repair or replace, free of charge, any product of its manufacture found to be defective at the time it is returned to the factory during the warranty period. This warranty does not cover damage or liability for the improper application of Banner products. This warranty is in lieu of any other warranty either expressed or implied.