

**1 or 2 Pole 16 A Step relays for direct 35 mm rail (EN 60715) mounting**

- 17.4 mm wide
- Test button with mechanical indicators
- Choice of 7 switching sequences
- AC coils and DC coils
- Identification label
- Possible to connect illuminated push buttons with the additional part 026.00
- 35 mm rail (EN 60715) mount
- Cadmium free contact material

20.21/22/24/26/27/28/23  
Screw terminal



FOR UL RATINGS SEE:  
"General technical information" page V

For outline drawing see page 3

**Contact specification**

Contact configuration	1 NO (SPST-NO)	2 NO (DPST-NO)	1NO+1NC (SPST-NO+SPST-NC)
Rated current/Maximum peak current	A 16/30	16/30	16/30
Rated voltage/ Maximum switching voltage	V AC 250/400	250/400	250/400
Rated load AC1	VA 4000	4000	4000
Rated load AC15 (230 V AC)	VA 750	750	750
Nominal lamp rating:			
230 V incandescent/halogen W	2000	2000	2000
fluorescent tubes with electronic ballast W	1000	1000	1000
fluorescent tubes with electromechanical ballast W	750	750	750
CFL W	400	400	400
230 V LED W	400	400	400
LV halogen or LED with electronic ballast W	400	400	400
LV halogen or LED with electromechanical ballast W	800	800	800
Minimum switching load	mW (V/mA) 1000 (10/10)	1000 (10/10)	1000 (10/10)
Standard contact material	AgSnO <sub>2</sub>	AgSnO <sub>2</sub>	AgSnO <sub>2</sub>

**Coil specification**

Nominal voltage (U <sub>N</sub> )	V AC (50/60 Hz)	8 - 12 - 24 - 48 - 110 - 120 - 230 - 240		
	V DC	12 - 24 - 48 - 110	12 - 24 - 48 - 110	12 - 24 - 48 - 110
Rated power AC/DC	VA (50 Hz)/W	6.5/5	6.5/5	6.5/5
Operating range	AC	(0.85...1.1)U <sub>N</sub> (50 Hz)/(0.9...1.1)U <sub>N</sub> (60 Hz)		
	DC	(0.9...1.1)U <sub>N</sub>	(0.9...1.1)U <sub>N</sub>	(0.9...1.1)U <sub>N</sub>

**Technical data**

Mechanical life AC/DC	cycles	300 · 10 <sup>3</sup>	300 · 10 <sup>3</sup>	300 · 10 <sup>3</sup>
Electrical life at rated load in AC1	cycles	100 · 10 <sup>3</sup>	100 · 10 <sup>3</sup>	100 · 10 <sup>3</sup>
Minimum/Maximum impulse duration		0.1 s/1 h (according to EN 60669)	0.1 s/1 h (according to EN 60669)	0.1 s/1 h (according to EN 60669)
Insulation between coil and contacts (1.2/50 μs)	kV	4	4	4
Ambient temperature range	°C	-40...+40	-40...+40	-40...+40
Protection category		IP 20	IP 20	IP 20

**Approvals** (according to type)



## Ordering information

Example: 20 series relay, 35 mm rail (EN 60715) mount, double phase switch, 2 NO 16 A contacts, coil rated at 12 V DC, AgSnO<sub>2</sub> contacts.

**2 0 . 2 2 . 9 . 0 1 2 . 4 0 0 0**

**Series**
**Type**

2 = 35 mm rail (EN 60715) mount

**No. of poles**

- 1 = Single phase switch 1 NO (SPST-NO)
- 2 = Double phase switch 2 NO (DPST-NO)
- 3 = Double phase switch 1 NC+ 1 NO (SPST-NO+SPST-NC)
- 4 = 4 sequence double phase switch 2 NO (DPST-NO)
- 6 = 3 sequence double phase switch 2 NO (DPST-NO)
- 7 = 3 sequence double phase switch 2 NO (DPST-NO)
- 8 = 4 sequence double phase switch 2 NO (DPST-NO)

**Contact material**

- 0 = AgNi
- 4 = AgSnO<sub>2</sub>

**Coil voltage**

See coil specifications

**Coil version**

- 8 = AC (50/60 Hz)
- 9 = DC

## Technical data

### Insulation

Dielectric strength		
between supply and contacts	V AC	3500
between open contacts	V AC	2000
between adjacent contacts	V AC	2000

### Other data

Power lost to the environment					
with rated current and coil deenergised	W	1.3 (20.21, 20.23, 20.28)	2.6 (20.22, 20.24, 20.26, 20.27)		
 Screw torque	Nm	0.8	0.8		
Max. wire size		<b>Coil terminals</b>		<b>Contact terminals</b>	
		solid cable	stranded cable	solid cable	stranded cable
	mm <sup>2</sup>	1 x 4 / 2 x 2.5	1 x 2.5 / 2 x 2.5	1 x 6 / 2 x 4	1 x 4 / 2 x 2.5
	AWG	1 x 12 / 2 x 14	1 x 14 / 2 x 14	1 x 10 / 2 x 12	1 x 12 / 2 x 14

If the coil is operated for a prolonged period of time, adequate ventilation of the relays must be provided - suggested gap of 9 mm between adjacent relays.





















## Coil specifications

### DC version data

Nominal voltage U <sub>N</sub>	Coil code	Operating range		Resistance R	Consumption I at U <sub>N</sub>
		U <sub>min</sub>	U <sub>max</sub>		
V		V	V	Ω	mA
12	9.012	10.8	13.2	27	440
24	9.024	21.6	26.4	105	230
48	9.048	43.2	52.8	440	110
110	9.110	99	121	2330	47

### AC version data

Nominal voltage U <sub>N</sub>	Coil code	Operating range		Resistance R	Consumption I at U <sub>N</sub> (50 Hz)
		U <sub>min</sub>	U <sub>max</sub>		
V		V	V	Ω	mA
8	8.008	6.8	8.8	4	800
12	8.012	10.2	13.2	7.5	550
24	8.024	20.4	26.4	27	275
48	8.048	40.8	52.8	106	150
110	8.110	93.5	121	590	64
120	8.120	102	132	680	54
230	8.230	192	253	2500	28
240	8.240	204	264	2700	27.5

Type	Number of steps	Sequence			
		1	2	3	4
20.21	2				
20.22	2				
20.23	2				
20.24	4				
20.26	3				
20.27	3				
20.28	4				

**Wiring diagrams**

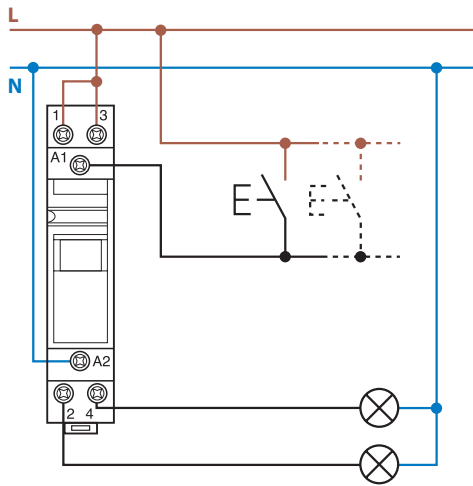

Example: 230 V AC supply voltage.

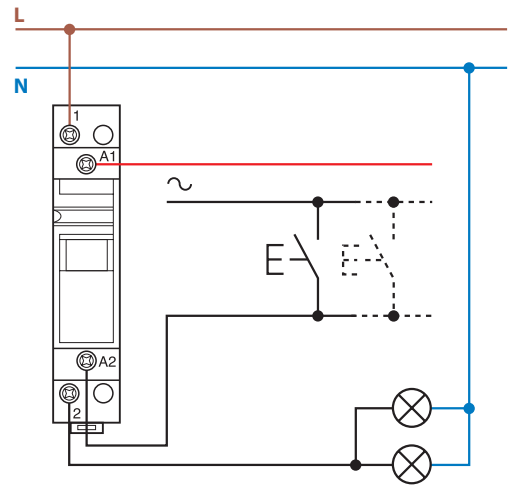

Example: 24 V AC supply voltage.

**Outline drawings**

20.21  
Screw terminal

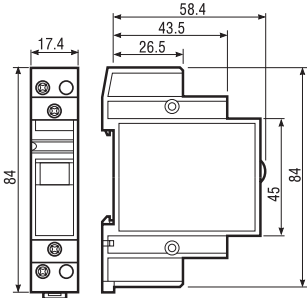

20.22/24/26/27/28  
Screw terminal

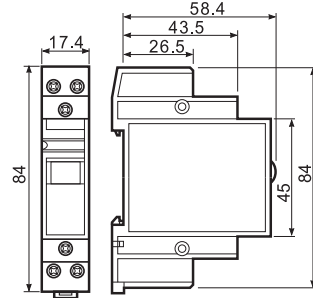

20.23  
Screw terminal

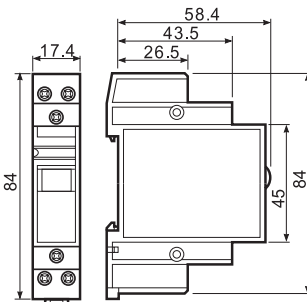

Accessories

Module for use with illuminated push-buttons

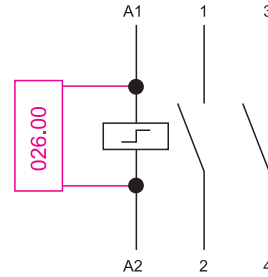
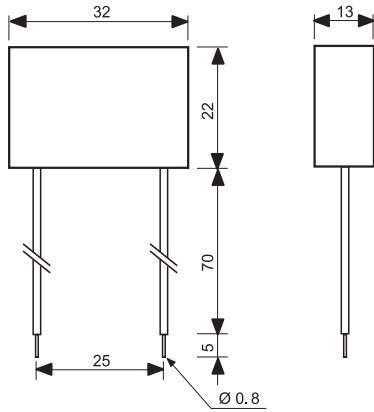

Type 026.00

Sealed construction, 7.5 cm insulated flexible wire termination.

Example of wiring diagram of type 026.00

This module is necessary when using between 1 and a maximum of 15 illuminated push buttons in the coil circuit (Each 1.5 mA max, 230 V AC). It must be connected in parallel to the coil of the relay.



020.01

Adaptor for panel mounting, 17.5 mm wide

020.01



020.24

Sheet of marker tags, plastic, 24 tags, 9 x 17 mm

020.24



022.09

Separator for rail mounting, plastic, 9 mm wide

022.09

