

ø22mm LED Pilot Light Indicators - AP22M Series

Sunlight-viewable – Ultra-bright LED Indicators!



Actual Size



Outstanding visibility, even in direct sunlight.

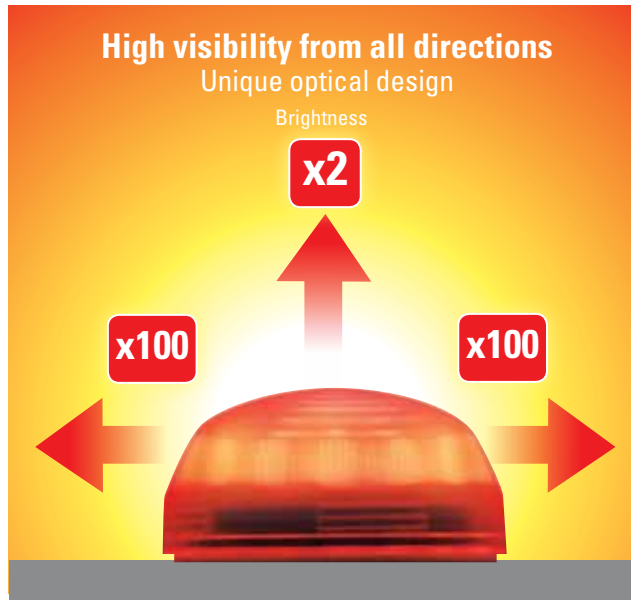

Twice as bright as standard pilot lights when viewed from the front, and up to 100 times brighter than standard pilot lights when viewed from side angles.

ø22mm Ultra-bright LED Pilot Lights - AP22M Series

Key Features

- Viewable in direct sunlight.
- Visible from all directions.
- The use of an ultra-bright LED that is not susceptible to external scattered light ensures high visibility and provides for more accurate recognition.
- Integrated terminal cover is IP20 (finger protection), preventing electrical shocks.
- UL and c-UL listed, EN standard compliant.
- Colored and clear lenses are offered.
- UL Type 4X



Specifications

Operating Temperature	-25 to +55°C (no freezing)	
Storage Temperature	-45 to +80°C (no freezing)	
Operating Humidity	45-85%RH (no condensation)	
Insulation Resistance	100MΩ (DC500V megger)	
Over Voltage Category	II (IEC60664-1)	
Impulse Dielectric Strength	2.5kV (IEC60664-1, IEC60947-5-1)	
Pollution Degree	3 (IEC60947-5-1)	
Dielectric Strength	Between terminals of different poles: 2,000V AC, 1 min Between live and non-live parts: 2,000V AC, 1 min	
Vibration Resistance	Operation limit	5-55Hz half amplitude: 0.5mm
	Damage limit	30Hz half amplitude: 1.5mm
Shock Resistance	Operation limit	100m/s ² (10G)
	Damage limit	1000m/s ² (100G)
Degree of Protection	Panel front: IP66 (IEC 60529), UL Type 4X Terminals: IP20	
Terminal Size	M3.5 screw	
Tightening Torque	Terminal Screw	1.0N•m
	Locking Ring	2.0N•m
Wire Size	AWG16 ~ AWG14, 2 wires max.	
Weight (approx.)	18g	

800.262.4332



www.IDEC.com/switches

LED Lamp Ratings

Rated Voltage	12V DC, 24V AC/DC, 120V AC	
Voltage Range	12V DC ±5%, 24V AC/DC ±10%, 120V AC ±10%	
LED Illumination Color	Red (R), Green (G), Yellow (Y), Amber (A), Blue (S), and White (PW)	
Rated Current	12V DC: R, A, Y - 21mA; G, S, PW - 22mA 24V AC/DC, 120V AC: 24mA (all colors)	
LED Life (Ref.)	Approx. 30,000 Hrs. at rated voltage @ 25°C in specified environmental conditions (The brightness reduces to 50% of initial value.)	
Equivalent Circuit	<p>Colors R, A, and Y</p>	<p>Colors G, S, & PW</p>
	<p>Drawing Key</p> <ul style="list-style-type: none"> — > LED Chip — > Rectifier Diode — > Zener Diode —□— Resistor 	



Part Numbers

Pilot Lights

Appearance	Lens	Rated Voltage	Part Number	Lamp Color
	Color	12V DC 24V AC/DC 120V AC	AP22M-2QⓄⓂ	R G Y A S PW
	Clear		AP22M-2QⓄCⓂ	R G Y A S

- In place of Ⓞ insert LED color code: R (red), G (green), Y (yellow), A (amber), S (blue), and PW (white).
- White (PW) only available as colored lens.
- In place of Ⓜ insert voltage code. For 12V DC use (3), for 24V AC/DC use (4), for 120V AC use (H).
- LED cannot be removed or replaced.

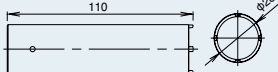
Accessories & Replacement Parts

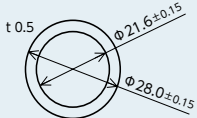
Appearance	Material	Part Number	Notes
	Metal (brass)	MW9Z-T1	Used for mounting unit into a panel. 
	Resin	YW9Z-PL12Ⓞ	Dimension: $\phi 29.8\text{mm}$ H14.5mm In place of Ⓞ insert color code: R (red), G (green), Y (yellow), A (amber), S (blue), C (clear*)
	Nitrile rubber	HW9Z-WM	

- Nameplates: HWAM, HWAS-0, and CWAM. Go to www.IDEC.com/usa and review HW and CW Series catalogs for detailed information.
- *Use a clear lens (C) for a PW (White) LED.

Dimensions (mm)

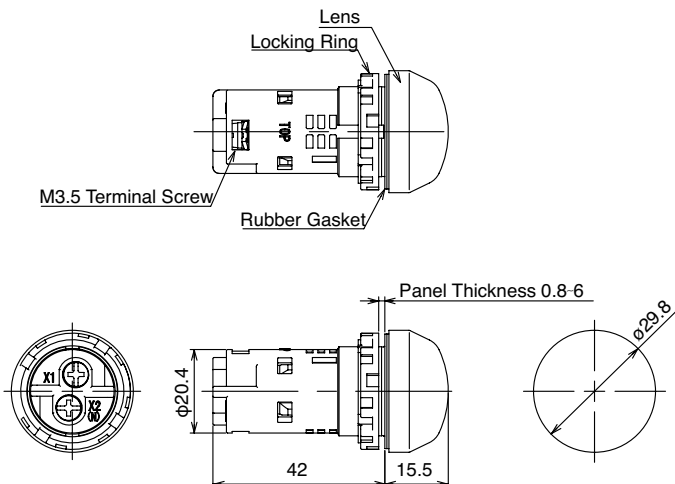

Panel cut-out (mm)

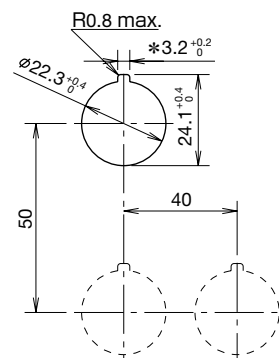

A 3.2mm^{+0.2} opening (notch) is used to stop rotation. (Not necessary if a nameplate is not used.)

Safety Instructions

Turn off the power before installation, removal, wiring, maintenance and inspection. Failure to turn off power may cause an electrical shock or fire hazard.

When wiring, use proper size wires (AWG16 - AWG14) to meet voltage and current requirements. Tighten the terminal screws to the recommended tightening torque (1.0N•m). Operating with loose terminal screws may cause overheating and fire.

Installation Instructions

Panel Mounting

Remove the locking ring and check if the rubber gasket is properly aligned. Then insert the AP22M unit, align the "TOP" marking with the recess into the panel cut-out, and tighten the locking ring.

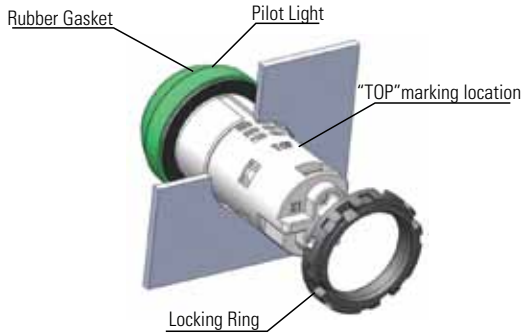

When installing the pilot light into a panel cut-out, use locking ring wrench (part number MW9Z-T1) to tighten the locking ring to the recommended torque of 2.0N•m. Do not use pliers and do not tighten excessively, otherwise the unit may become damaged.

Mounting Notes

Applicable Wires

The applicable wire sizes are from AWG14 to AWG16 with 2 wires max. A ring-tongue terminal cannot be used.

Applicable Terminal

Fork Crimp Terminal

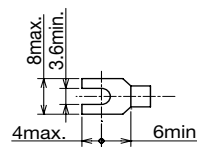

Ferule Crimp Terminal

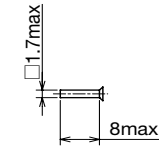

Bare Wire

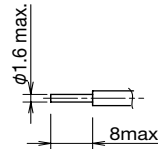

Noise

External noise may cause the LED chips to deteriorate, leading to a reduction in brightness, a change in color, or malfunction. We recommend the following solution if this problem exists. However, please note that this solution will vary depending on the operating environment and the application.

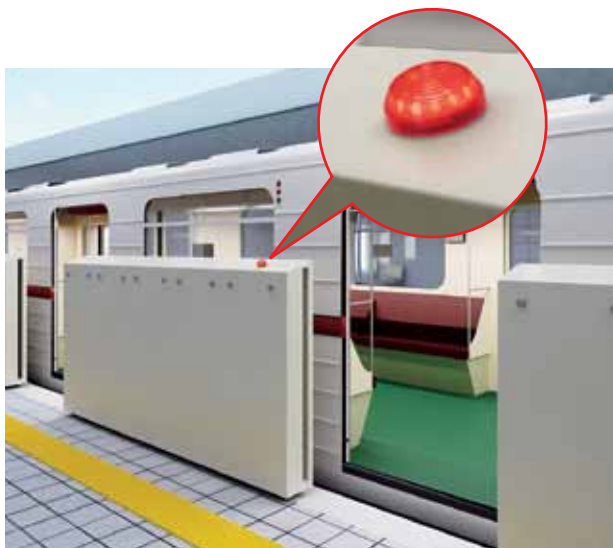
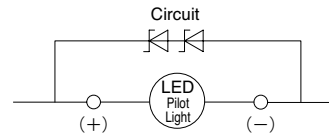

Great Visibility - even from inside a train (automatic safety fence on a train station platform)



Compact Size - Perfect for mounting in small or narrow surfaces.

