

SX-F/G-SG-ST SERIES

The emitter-receiver photocells of the **Sx-F/G-SG-ST** series have been homologated to function with the control units of the SG-BWS series that together form a safety system respectively of **Type 2** and **Type 4** conforming with the **EN 954-1** and **EN ISO 13849-1** Standards.

The photocells are available in the **M18 tubular plastic** format with infrared emission of the **S5** series for distances reaching **8m**, M18 plastic tubular format with laser emission of the **SL5** series with operating range reaching **40m**, and MAXI format with infrared emission of the new **S300** series with operating range reaching a respectively 50m for Type 2 and 40m for Type 4 models. Together with S300 standard models **DEFOGGING MODELS** with heated front glass are available for applications where sudden changes of the temperature in the nearby of the sensor are causing condensation.

All models are equipped with **M12 4-pole connector**: no cable or terminal block models are available. LEDs signal both the operating status and correct alignment of the safety photocells.

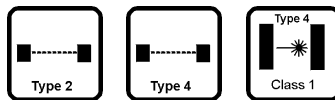

HIGHLIGHTS

- Emitter-receiver photocells with test input
- Type 2 and Type 4 models
- Plastic tubular and MAXI
- Photocells with standard M12 connectors
- IR emission models for distances reaching 8m, 40m, 50m
- Class 1 laser emission models for distances reaching 40m

APPLICATIONS

Extreme reliability and simplicity make the SX-F/G-SG-ST together with SG-BWS control units the ideal solution for the following applications:

- Automatic warehouses
- Machines for food packaging
- Robots
- Automatic assembling lines
- Machines for PCB production

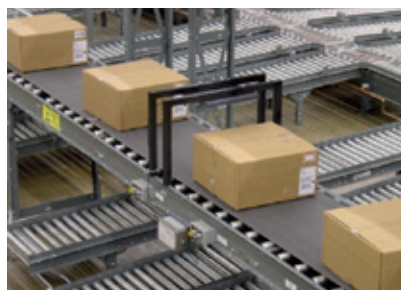

DIMENSIONS

S5 and SL5

S5-5-F8-92-SG-ST2

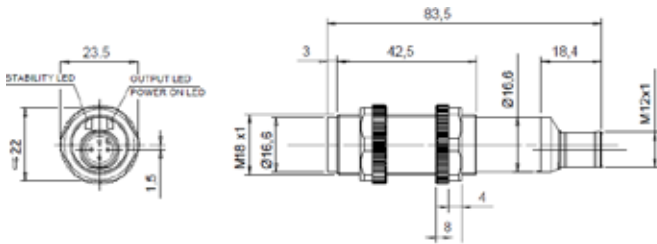

S5-5-G8-62-SG-ST2

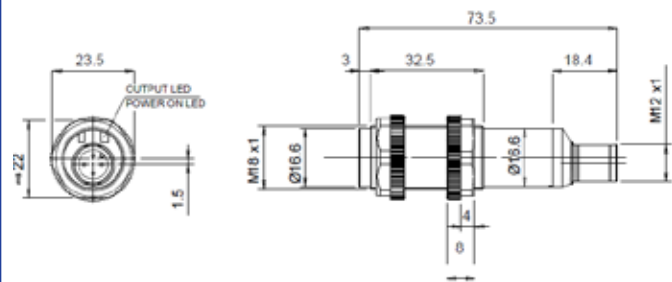

S5-5-F8-92-SG-ST4

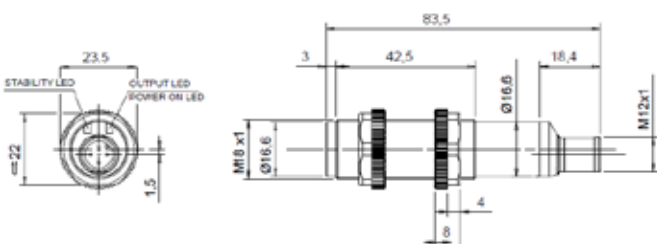

S5-5-G8-62-SG-ST4

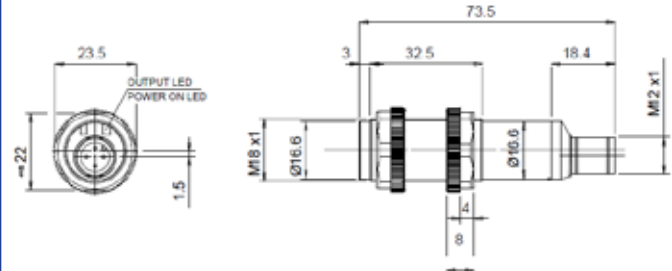

SL5-5-F-92-SG-ST4

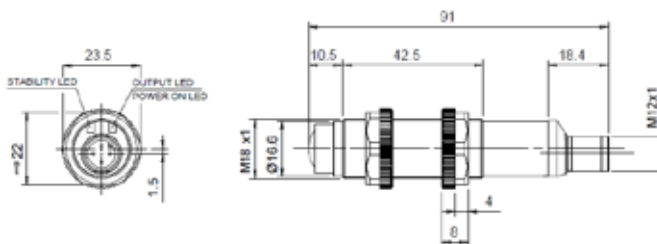

SL5-5-G-82-SG-ST4

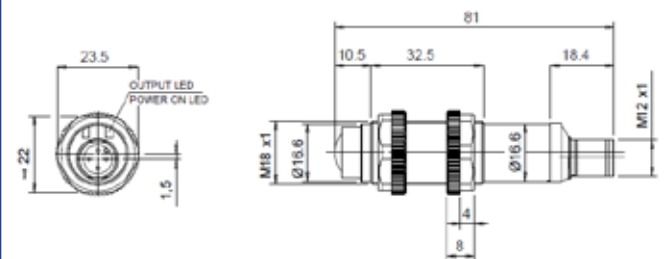

S300

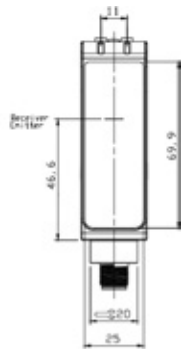
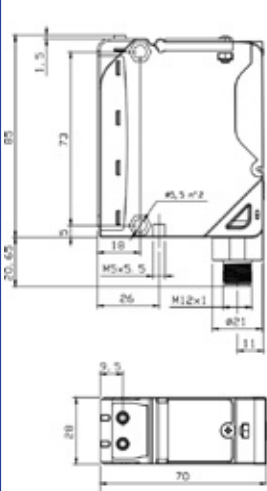

Dimensions in mm

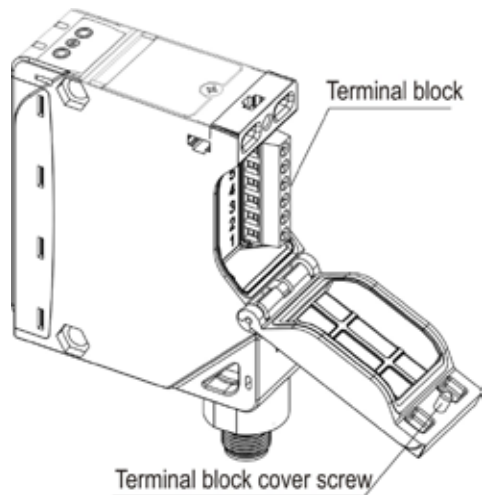

CONNECTIONS S5/SL5 F/G

S5/SL5 F

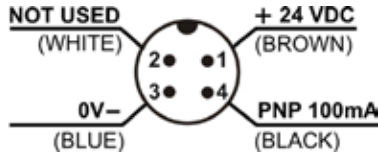

S5/SL5 G

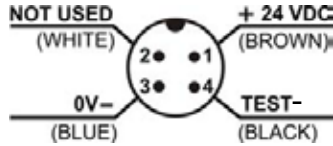

CONNECTIONS S300 F/G

S300 F

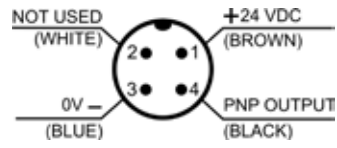

S300 G

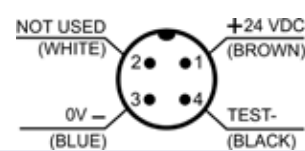

DETECTION DIAGRAMS

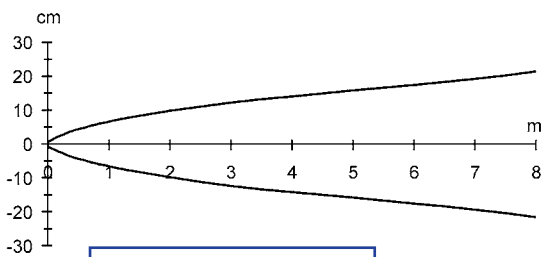

S5-F/G- SG-ST2

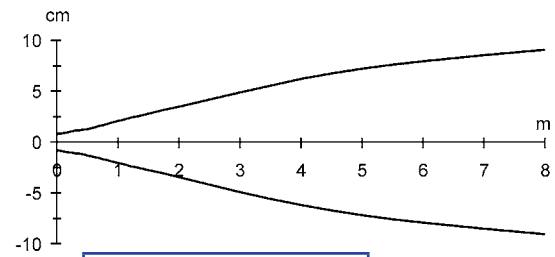

S5-F/G- SG-ST4

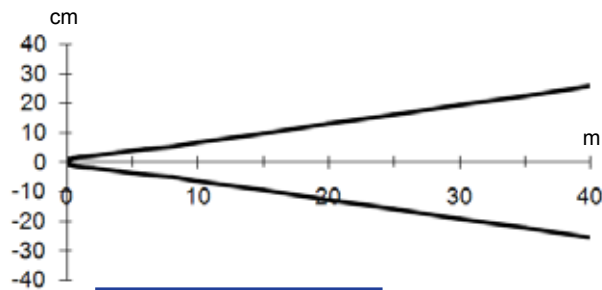

SL5-F/G- SG-ST4

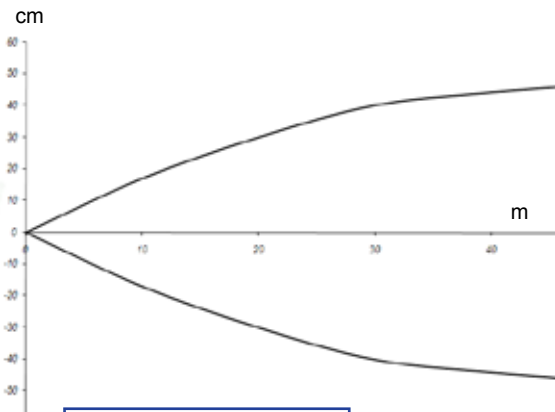

S300-F/G- SG-ST2

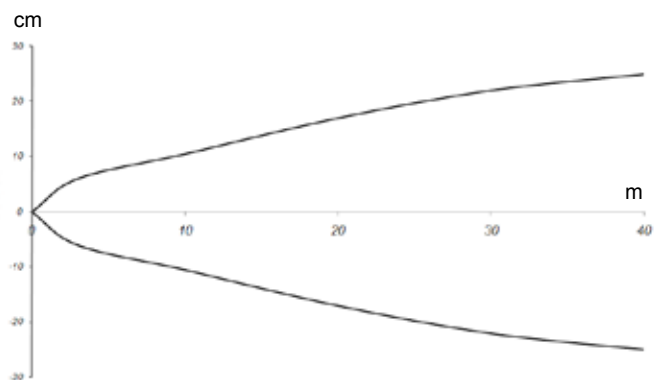

S300-F/G- SG-ST4

TECHNICAL DATA

S5/SL5

	SL5...SG-ST4	S5...SG-ST2/ST4
Power supply:	24 Vdc \pm 15%	
Consumption (excluded output current):	35 mA max.	30 mA max.
Outputs:	PNP (short-circuit protection)	
Output current:	100 mA max.	
Output saturation voltage:	2 V max.	
Leakage current:	50 μ A at 30 Vdc	
Response time:	1 ms max.	
Switching frequency:	500 Hz max.	
Operating temperature:	-10 ... 50 °C	-25 ... 55 °C
Storage temperature:	-25 ... 70 °C	
Dielectric strength:	500 Vac / 1 min. between electronic parts and housing	
Insulating resistance	>20 M Ω / 500 Vdc, between electronic parts and housing	
Operating distance (min. values):	0 ... 40 m	0...8 m
Emission type:	red Laser (650 nm) Class 1 EN 60825-1 (1994)	LED infrared 880 nm
Effective aperture angle:	xx...ST2 = \pm 5° / xx...ST4 = \pm 2.5°	
Ambient light rejection:	according to EN 60947-5-2	
Vibration:	0.5 mm amplitude, 10 ... 55 Hz frequency, for each axis (EN60068-2-6)	
Shock resistance:	11 ms (30 G) 6 shocks for each axis (EN60068-2-27)	
Housing material:	ABS UL 94V-O	
Connector/gland material:	Polycarbonate	
Lens material:	PMMA	
Mechanical protection:	IP67	
Connections:	M12 4-pole connector	
Weight:	30 g. max.	

S300

DC MODELS	S300...2/5-G/F-ST2/ST4	
Power supply:	24 VDC \pm 15%	
Ripple:	10 % max	
Consumption (excluded output current):	S300...F: <25mA S300...G: < 20 mA	
Outputs:	PNP NC open collector	
Output current:	100 mA (resistive load)	
Output saturation voltage:	2.4 V max	
Diagnostic functions	Test- input	
Response time:	1 ms	
Switching frequency:	500 Hz	
Weight:	140 g	
Common data	S300...G	S300...F
Emission type:	INFRARED LED (880nm)	
Operating distance (typical value):	S300...ST2: 0..50m S300...ST4: 0..40m	
EAA:	S300...ST2: \pm 5° / S300...ST4: \pm 2.5°	
Indicators:	POWER ON LED (GREEN)	OUTPUT LED (YELLOW), STABILITY LED (GREEN)
Operating temperature:	-40...55 °C	
Storage temperature:	-40...70 °C	
Insulating resistance:	> 20 M Ω , 500 VDC between electronics and housing	
Ambient light rejection:	EN 60947-5-2	
Vibration:	0.5 mm amplitude, 10 ... 55 Hz frequency, for every axis (EN60068-2-6)	
Shock resistance:	11 ms (30 G) 6 shock for every axis (EN60068-2-27)	
Housing:	PBT 30% Glass fiber-reinforced	
Lenses:	frontal window and lens in PC	
Protection class:	IP67 (IEC / EN60529) / cable gland EN50262	
UL requirements:	Class 2 power supply; 60-70°C copper conductor 24-20 AWG; Type 1 Enclosure	
Connections:	see the "CONNECTIONS" paragraph	



MODEL SELECTION AND ORDER INFORMATION

S5

MODEL	DESCRIPTION	CODE
S5-5-G8-62-SG-ST2	S5-5-G8-62-SG-ST2 emitter, 10/30Vdc, Type 2	952051870
S5-5-F8-92-SG-ST2	S5-5-F8-92-SG-ST2 receiver, 10/30Vdc, Type 2	952051890
S5-5-G8-62-SG-ST4	S5-5-G8-62-SG-ST4 emitter, 10/30Vdc, Type 4	952051910
S5-5-F8-92-SG-ST4	S5-5-F8-92-SG-ST4 receiver, 10/30Vdc, Type 4	952051930

SL5

MODEL	DESCRIPTION	CODE
SL5-5-G-82-SG-ST4	SL5-5-G-82-SG-ST4 Laser emitter, 40m, M12, Type 4	952501160
SL5-5-F-92-SG-ST4	SL5-5-F-92-SG-ST4 receiver, 40m, PNP, Light, M12, Type 4	952501170

S300

MODEL	DESCRIPTION	CODE
S300-PR-5-G00-EX-SG-ST2	S300-PR-5-G00-EX-SG-ST2 emitter 10/30Vdc Type 2	951451320
S300-PR-5-G00-EX-M-SG-ST2	S300-PR-5-G00-EX-M-SG-ST2 emitter 10/30Vdc Type 2 defogging	951451330
S300-PR-5-F00-OC-SG-ST2	S300-PR-5-F00-OC-SG-ST2 receiver 10/30Vdc Type 2	951451340
S300-PR-5-F00-OC-M-SG-ST2	S300-PR-5-F00-OC-M-SG-ST2 receiver 10/30Vdc Type 2 defogging	951451350
S300-PR-5-G00-EX-SG-ST4	S300-PR-5-G00-EX-SG-ST4 emitter 10/30Vdc Type 4	951451360
S300-PR-5-G00-EX-M-SG-ST4	S300-PR-5-G00-EX-M-SG-ST4 emitter 10/30Vdc Type 4 defogging	951451370
S300-PR-5-F00-OC-SG-ST4	S300-PR-5-F00-OC-SG-ST4 receiver 10/30Vdc Type 4	951451380
S300-PR-5-F00-OC-M-SG-ST4	S300-PR-5-F00-OC-M-SG-ST4 receiver 10/30Vdc Type 4 defogging	951451390

NOTE: THE SAFETY PHOTOCELLS LISTED ABOVE ARE CERTIFIED AND MUST BE USED ONLY WITH SAFETY CONTROL UNITS SG-BWS-T4 AND SG-BWS-T4-MT SERIES. NEITHER TECHNICAL AND FUNCTIONING COMPATIBILITY NOR CERTIFICATIONS ARE GUARANTEE IF USING THEM WITH OTHER BRAND CONTROL UNITS OR OLD/OBSOLETE DATALOGIC AUTOMATION CONTROL UNITS

ACCESSORIES SELECTION AND ORDER INFORMATION

MODEL	DESCRIPTION	CODE
CS-A1-02-U-03	4-pole M12 cable (axial) 3 m	95ASE1120
CS-A1-02-U-05	4-pole M12 cable (axial) 5 m	95ASE1130
CS-A1-02-U-10	4-pole M12 cable (axial) 10 m	95ASE1140
CS-A1-02-U-15	4-pole M12 cable (axial) 15 m	95ASE1150
CS-A1-02-U-25	4-pole M12 cable (axial) 25 m	95ASE1160
SP-40	fixed support for tubular M18 sensors	95ACC1370
SWING-18	adjustable support for plastic tubular M18 sensors	895000006
MICRO-18	support with micrometric regulation for tubular M18 sensors	95ACC1380
ST-5099	S300 FIXED BRACKET	95ACC2830
ST-5100	S300 FIXED BRACKET	95ACC2840
DataVS-MK-01	S300 MOUNTING KIT	95A901380

Note: for S5, SL5 fixing brackets and supports dimensional 2D dimensional drawings please refer to the corresponding datasheets

S300 ACCESSORY DRAWINGS

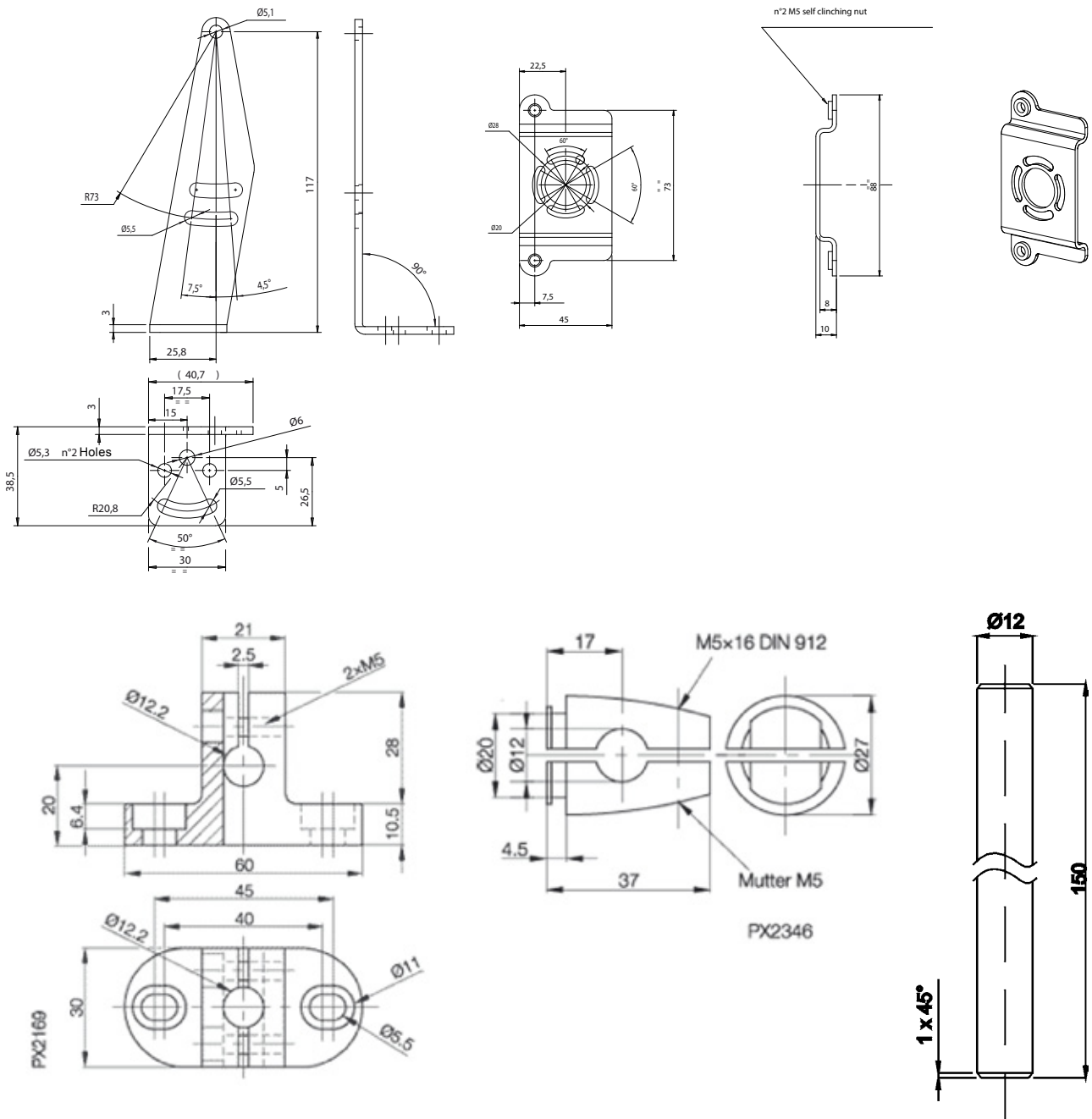

The company endeavours to continuously improve and renew its products; for this reason the technical data and contents of this catalogue may undergo variations without prior notice. For correct installation and use, the company can guarantee only the data indicated in the instruction manual supplied with the products.