

Transistor Sink Output Module Specifications

Type No.	FC4A-T08K1	FC4A-T16K3	FC4A-T32K3	
Output Type	Transistor sink output			
Output Points and Common Lines	8 points in 1 common line	16 points in 1 common line	32 points in 2 common lines	
Terminal Arrangement	See Transistor Sink Output Module Terminal Arrangement on pages 2-46 and 2-47.			
Rated Load Voltage	24V DC			
Operating Load Voltage Range	20.4 to 28.8V DC			
Rated Load Current	0.3A per output point	0.1A per output point		
Maximum Load Current (at 28.8V DC)	0.3A per output point 3A per common line	0.1A per output point 1A per common line		
Voltage Drop (ON Voltage)	1V maximum (voltage between COM and output terminals when output is on)			
Inrush Current	1A maximum			
Leakage Current	0.1 mA maximum			
Clamping Voltage	39V±1V			
Maximum Lamp Load	8W			
Inductive Load	L/R = 10 ms (28.8V DC, 1 Hz)			
External Current Draw	100 mA maximum, 24V DC (power voltage at the +V terminal)			
Isolation	Between output terminal and internal circuit: Between output terminals:		Photocoupler isolated Not isolated	
Connector on Mother Board	MC1.5/10-G-3.81BK (Phoenix Contact)	FL20A2MA (Oki Electric Cable)		
Connector Insertion/Removal Durability	100 times minimum			
Internal Current Draw	All Outputs ON	10 mA (5V DC) 20 mA (24V DC)	10 mA (5V DC) 40 mA (24V DC)	20 mA (5V DC) 70 mA (24V DC)
	All Outputs OFF	5 mA (5V DC) 0 mA (24V DC)	5 mA (5V DC) 0 mA (24V DC)	10 mA (5V DC) 0 mA (24V DC)
Internal Power Consumption (at 24V DC while all outputs ON)	0.55W	1.03W	1.82W	
Output Delay	Turn ON time: 300 μs maximum Turn OFF time: 300 μs maximum			
Weight (approx.)	85g	70g	105g	

Output Internal Circuit

Sink Output

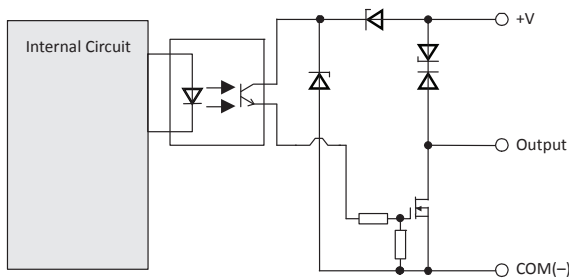

2: MODULE SPECIFICATIONS

Transistor Sink Output Module Terminal Arrangement and Wiring Diagrams

FC4A-T08K1 (8-point Transistor Sink Output Module) — Screw Terminal Type

Applicable Terminal Block: FC4A-PMT10P (supplied with the output module)

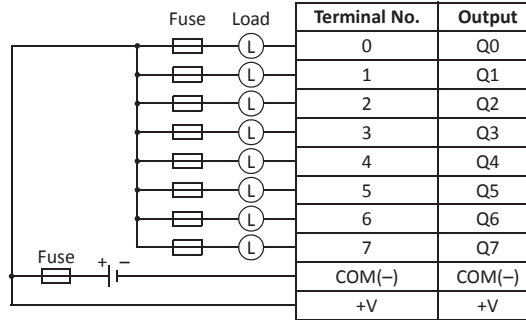
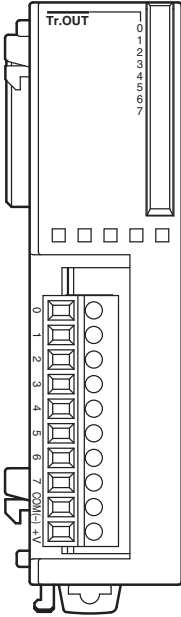

- Connect a fuse appropriate for the load.
- For output wiring precautions, see page 3-16.

FC4A-T16K3 (16-point Transistor Sink Output Module) — Connector Type

Applicable Connector: FC4A-PMC20P (*not* supplied with the output module)

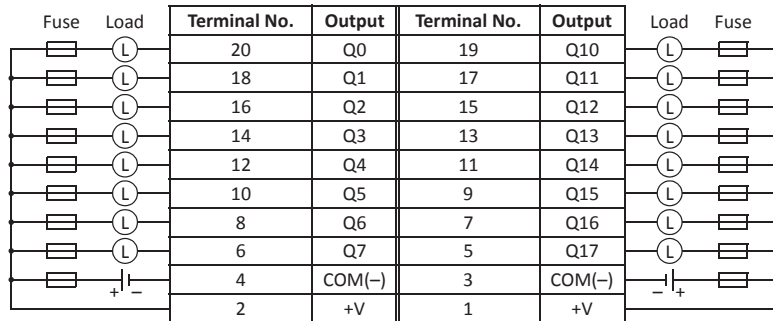
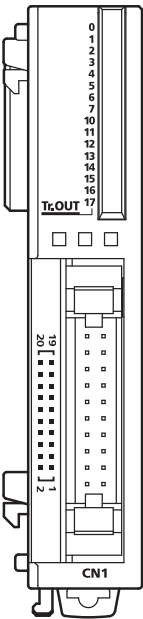

- COM(-) terminals are interconnected.
- +V terminals are interconnected.
- Connect a fuse appropriate for the load.
- For output wiring precautions, see page 3-16.

FC4A-T32K3 (32-point Transistor Sink Output Module) — Connector Type

Applicable Connector: FC4A-PMC20P (not supplied with the output module)

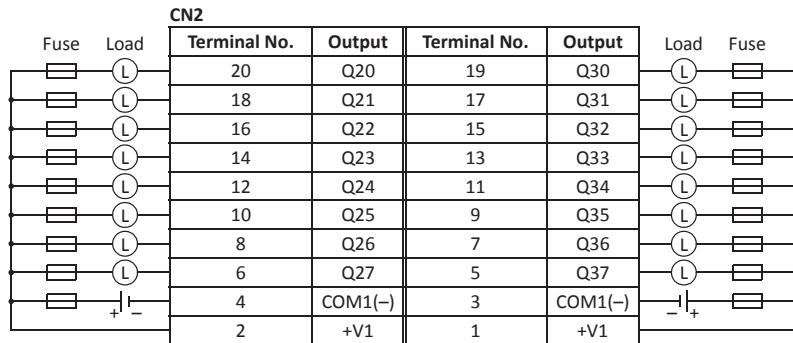
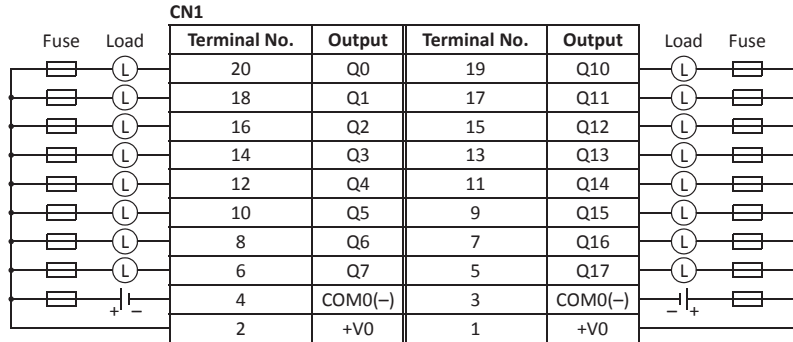
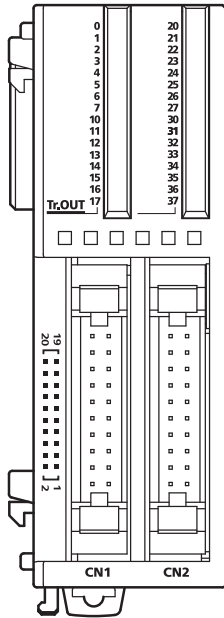

- Terminals on CN1 and CN2 are *not* interconnected.
- COM0(-) terminals are interconnected.
- COM1(-) terminals are interconnected.
- +V0 terminals are interconnected.
- +V1 terminals are interconnected.
- Connect a fuse appropriate for the load.
- For output wiring precautions, see page 3-16.