

**A3**

**Switches & Pilot Devices**



## LW Series offer flexibility in space-saving package

### Key features include:

- PC board mount, solder or screw terminal
- Collective mounting saves space
- Non-reflective lens
- Highly visible marking plate
- Tamper proof construction
- Light touch reduces strain
- Gold or silver contacts
- Removable contacts simplify wiring and facilitate PCB applications

LW Series switches and pilot lights can be mounted collectively on 1.0" centers. Combined with pcb terminals and locking lever removable contacts, this eases manufacture of pre-fab pushbutton arrays (as pictured). PC Board tracing/soldering of contacts can be done in tandem with panel cutting/operator installation.

All LW series units mount by means of a locking ring that comes on from the rear of the panel, as such they can not be removed from outside the panel and are relatively tamperproof.

Combining the snap action and tactile feel of miniature commercial pushbuttons with the size and ruggedness of industrial pushbuttons, LW pushbuttons are a unique solution to many applications.

Choose from standard silver contacts or low-level gold plated contacts. Terminals available in .110" solder tab, M3 screw, or pcb pins.

## Specifications

|                       |  |  |   |  |
|-----------------------|--|--|---|--|
| <b>Specifications</b> | <b>Operating Temperature</b>   | -25 to +60°C (without freezing) LED illuminated type: -25 to +50°C   |   |  |
|                       | <b>Storage Temperature</b>   | -40 to +80°C   |   |  |
|                       | <b>Operating Humidity</b>  | 45 to 85% RH   |   |  |
|                       | <b>Contact Resistance</b>  | 50mΩ maximum (initial value)   |   |  |
|                       | <b>Insulation Resistance</b>   | 100MΩ minimum (500V DC megger)   |   |  |
|                       | <b>Dielectric Strength</b>   | <b>Switch Unit</b>   | Between live part and ground: 2,500V AC, 1 minute<br>Between terminals of different poles: 2,500V AC, 1 minute<br>Between terminals of the same pole: 1,000V AC, 1 minute |  |
|                       |  | <b>Illumination Unit</b>   | Between live part and ground: 2,500V AC, 1 minute   |  |
|                       | <b>Vibration Resistance</b>  | Operating extremes: 5 to 55Hz, Amplitude 1.0mm p-p   |   |  |
|                       | <b>Shock Resistance</b>  | Damage limits: 1,000 m/sec <sup>2</sup> (Approx. 100G)<br>Operating extremes: 100 m/sec <sup>2</sup> (Approx. 10G)                           |   |  |
|                       | <b>Mechanical Life</b>   | Momentary: 1,000,000 operations minimum<br>Maintained: 500,000 operations minimum<br>Selectors: 250,000 operations minimum                   |   |  |
|                       | <b>Electrical Life</b>   | Momentary: 100,000 operations minimum (at 1,800 operations/hour)<br>Maintained/Selector: 100,000 operations minimum (at 900 operations/hour) |   |  |
|                       | <b>Degree of Protection</b>  | Watertight/oiltight IP65 (IEC Pub529) (except key selectors)   |   |  |
|                       | <b>Insulation Voltage</b>  | 250VAC/DC  |   |  |
|                       | <b>Materials</b>   | <b>Lenses</b>  | polyarylate   |  |
| <b>Operators</b>      |  | polyacetate  |   |  |
| <b>Marking Plates</b> |  | acrylic resin  |   |  |
| <b>Terminal Style</b> | .110" Solder tab/quick connect<br>PC board terminal (gold contacts only)<br>Screw terminal (DPDT units only) |  |   |  |

A3

Switches & Pilot Devices

| <b>Contact Ratings</b>          | <b>Contact Material</b>    | <b>Thermal Current</b>   | <b>Contact Rating</b>         | <b>Remarks</b> |   |
|---------------------------------|----------------------------|--|-------------------------------|----------------|---|
|                                 | <b>Gold-clad cross-bar</b> | 3A   | 30VDC/0.1A resistive          |                | Minimum applicable load (reference value): 5V, 1mA AC/DC.<br>(Applicable range is subject to the operating condition and load.) |
|                                 |                            |  | 125VAC/0.1A resistive         |                |   |
|                                 | <b>Silver Contact</b>      | 5A   | 30VDC/2A resistive            |                |   |
|                                 |                            |  | 30VDC/1A inductive            |                |   |
|                                 |                            |  | 125VAC/3A resistive(50/60Hz)  |                |   |
|                                 |                            |  | 125VAC/2A inductive (50/60Hz) |                |   |
|                                 |                            |  | 125VDC/0.4A resistive         |                |   |
|                                 |                            |  | 125VDC/0.2A inductive         |                |   |
|                                 |                            |  | 250VAC/2A resistive(50/60Hz)  |                |   |
| 250VAC/1.5A inductive (50/60Hz) |                            |  |                               |                |   |
|                                 |                            | AC inductive load: PF=0.6 to 0.7,<br>DC inductive load: L/R=7ms maximum. |                               |                |   |

### Lamp Ratings

|                     | <b>Voltage</b> | <b>Current/Wattage</b> |
|---------------------|----------------|------------------------|
| <b>LED</b>          | 6V AC/DC ±10%  | 17mA max               |
|                     | 12V AC/DC ±10% | 11mA max               |
|                     | 24V AC/DC ±10% | 11mA max               |
|                     | 120V AC ±10%   | 10mA max               |
|                     | 240V AC ±10%   | 10mA max               |
| <b>Incandescent</b> | 6.3V AC/DC ±5% | 1W                     |
|                     | 12V AC/DC ±10% | 1W                     |
|                     | 24V AC/DC ±10% | 1W                     |

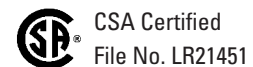





LED lamps contains a built-in current-limiting resistor and reverse polarity protection diode.

## Non-Illuminated Pushbuttons (Assembled)

### Part Numbers: LW1B/LW2B Pushbuttons

A3

Switches & Pilot Devices

| Style  | Contact Material | Contact | Part Number |              |              |                       |              |              |
|--|------------------|---------|-------------|--------------|--------------|-----------------------|--------------|--------------|
|  |                  |         | Momentary   |              |              | Maintained (Latching) |              |              |
|  |                  |         | Solder/Tab  | PC Board     | Screw        | Solder/Tab            | PC Board     | Screw        |
| <br>Round Flush       | Gold             | SPDT    | LW1B-M1C1-① | LW1B-M1C1V-① | —            | LW1B-A1C1-①           | LW1B-A1C1V-① | —            |
|  |                  | DPDT    | LW1B-M1C2-① | LW1B-M1C2V-① | LW1B-M1C2M-① | LW1B-A1C2-①           | LW1B-A1C2V-① | LW1B-A1C2M-① |
|  |                  | 3PDT    | LW1B-M1C3-① | LW1B-M1C3V-① | —            | LW1B-A1C3-①           | LW1B-A1C3V-① | —            |
|  | Silver           | SPDT    | LW1B-M1C5-① | —            | —            | LW1B-A1C5-①           | —            | —            |
|  |                  | DPDT    | LW1B-M1C6-① | —            | LW1B-M1C6M-① | LW1B-A1C6-①           | —            | LW1B-A1C6M-① |
|  |                  | 3PDT    | LW1B-M1C7-① | —            | —            | LW1B-A1C7-①           | —            | —            |
| <br>Square Flush      | Gold             | SPDT    | LW2B-M1C1-① | LW2B-M1C1V-① | —            | LW2B-A1C1-①           | LW2B-A1C1V-① | —            |
|  |                  | DPDT    | LW2B-M1C2-① | LW2B-M1C2V-① | LW2B-M1C2M-① | LW2B-A1C2-①           | LW2B-A1C2V-① | LW2B-A1C2M-① |
|  |                  | 3PDT    | LW2B-M1C3-① | LW2B-M1C3V-① | —            | LW2B-A1C3-①           | LW2B-A1C3V-① | —            |
|  | Silver           | SPDT    | LW2B-M1C5-① | —            | —            | LW2B-A1C5-①           | —            | —            |
|  |                  | DPDT    | LW2B-M1C6-① | —            | LW2B-M1C6M-① | LW2B-A1C6-①           | —            | LW2B-A1C6M-① |
|  |                  | 3PDT    | LW2B-M1C7-① | —            | —            | LW2B-A1C7-①           | —            | —            |
| <br>Round Extended    | Gold             | SPDT    | LW1B-M2C1-① | LW1B-M2C1V-① | —            | LW1B-A2C1-①           | LW1B-A2C1V-① | —            |
|  |                  | DPDT    | LW1B-M2C2-① | LW1B-M2C2V-① | LW1B-M2C2M-① | LW1B-A2C2-①           | LW1B-A2C2V-① | LW1B-A2C2M-① |
|  |                  | 3PDT    | LW1B-M2C3-① | LW1B-M2C3V-① | —            | LW1B-A2C3-①           | LW1B-A2C3V-① | —            |
|  | Silver           | SPDT    | LW1B-M2C5-① | —            | —            | LW1B-A2C5-①           | —            | —            |
|  |                  | DPDT    | LW1B-M2C6-① | —            | LW1B-M2C6M-① | LW1B-A2C6-①           | —            | LW1B-A2C6M-① |
|  |                  | 3PDT    | LW1B-M2C7-① | —            | —            | LW1B-A2C7-①           | —            | —            |
| <br>Square Extended | Gold             | SPDT    | LW2B-M2C1-① | LW2B-M2C1V-① | —            | LW2B-A2C1-①           | LW2B-A2C1V-① | —            |
|  |                  | DPDT    | LW2B-M2C2-① | LW2B-M2C2V-① | LW2B-M2C2M-① | LW2B-A2C2-①           | LW2B-A2C2V-① | LW2B-A2C2M-① |
|  |                  | 3PDT    | LW2B-M2C3-① | LW2B-M2C3V-① | —            | LW2B-A2C3-①           | LW2B-A2C3V-① | —            |
|  | Silver           | SPDT    | LW2B-M2C5-① | —            | —            | LW2B-A2C5-①           | —            | —            |
|  |                  | DPDT    | LW2B-M2C6-① | —            | LW2B-M2C6M-① | LW2B-A2C6-①           | —            | LW2B-A2C6M-① |
|  |                  | 3PDT    | LW2B-M2C7-① | —            | —            | LW2B-A2C7-①           | —            | —            |
| <br>Mushroom        | Gold             | SPDT    | LW1B-M3C1-① | LW1B-M3C1V-① | —            | LW1B-A3C1-①           | LW1B-A3C1V-① | —            |
|  |                  | DPDT    | LW1B-M3C2-① | LW1B-M3C2V-① | LW1B-M3C2M-① | LW1B-A3C2-①           | LW1B-A3C2V-① | LW1B-A3C2M-① |
|  |                  | 3PDT    | LW1B-M3C3-① | LW1B-M3C3V-① | —            | LW1B-A3C3-①           | LW1B-A3C3V-① | —            |
|  | Silver           | SPDT    | LW1B-M3C5-① | —            | —            | LW1B-A3C5-①           | —            | —            |
|  |                  | DPDT    | LW1B-M3C6-① | —            | LW1B-M3C6M-① | LW1B-A3C6-①           | —            | LW1B-A3C6M-① |
|  |                  | 3PDT    | LW1B-M3C7-① | —            | —            | LW1B-A3C7-①           | —            | —            |

- In place of ①, specify Button Color Code from table below.
- For sub-assembly part numbers, see page A3-111.
- For dimensions, see page A3-120.
- For accessories, see page A3-119.

### Part Numbers: Buzzers (IP20)

| Style   |          | Part Number |            |
|---|----------|-------------|------------|
|   |          | Solder Tab  | PCB        |
|  | Basic    | LW1Z-1X4    | LW1Z-1X4V  |
|   | With LED | LW1Z-1X4D   | LW1Z-1X4DV |

### ① Button Color Code

| Color  | Code |
|--------|------|
| Black  | B    |
| Green  | G    |
| Red    | R    |
| Blue   | S    |
| White  | W    |
| Yellow | Y    |

 12-24V AC/DC +/- 10%  
 80 dB (at 0.1m)  
 7mA (DC), 20mA (AC)

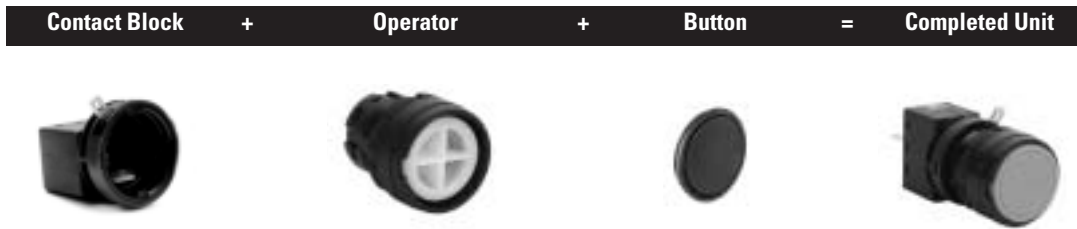

## Non-Illuminated Pushbuttons (Sub-Assembled)



### Part Numbers: Operators

| Style    |  | Part Number |            |
|----------|--|-------------|------------|
|          |  | Momentary   | Maintained |
| Round    |   | LW1B-M0     | LW1B-A0    |
| Square   |   | LW2B-M0     | LW2B-A0    |
| Mushroom |  | LW1B-M0L    | LW1B-A0L   |

### Part Numbers: Buttons

| Type     |   | Part Number |           |
|----------|---|-------------|-----------|
|          |   | Flush       | Extended  |
| Round    |  | LW1A-B1-①   | LW1A-B2-① |
| Square   |  | LW2A-B1-①   | LW2A-B2-① |
| Mushroom |  | —           | LW1A-B3-① |

#### ① Button Color Code

| Color  | Code |
|--------|------|
| Black  | B    |
| Green  | G    |
| Red    | R    |
| Blue   | S    |
| White  | W    |
| Yellow | Y    |



In place of ①, specify Button Color Code from table at right.

### Part Numbers: Contact Blocks



| Appearance  | Contact Material | Contact | Part Number |          |        |
|---|------------------|---------|-------------|----------|--------|
|   |                  |         | Solder/Tab  | PC Board | Screw  |
|  | Gold             | SPDT    | LW-C1       | LW-C1V   | —      |
|   |                  | DPDT    | LW-C2       | LW-C2V   | LW-C2M |
|   |                  | 3PDT    | LW-C3       | LW-C3V   | —      |
|   | Silver           | SPDT    | LW-C5       | —        | —      |
|   |                  | DPDT    | LW-C6       | —        | LW-C6M |
|   |                  | 3PDT    | LW-C7       | —        | —      |

## LED and Incandescent Illuminated Pushbuttons (Assembled)

### Part Numbers: LW1L/LW2L Illuminated Pushbuttons (LED and Incandescent)



A3

Switches & Pilot Devices

| Style  | Contact Material | Contact | Part Number  |               |               |                       |               |               |
|--|------------------|---------|--------------|---------------|---------------|-----------------------|---------------|---------------|
|  |                  |         | Momentary    |               |               | Maintained (Latching) |               |               |
|  |                  |         | Solder/Tab   | PC Board      | Screw         | Solder/Tab            | PC Board      | Screw         |
| <br>Round     | Gold             | SPDT    | LW1L-M1C10-② | LW1L-M1C10V-② | —             | LW1L-A1C10-②          | LW1L-A1C10V-② | —             |
|  |                  | DPDT    | LW1L-M1C20-② | LW1L-M1C20V-② | LW1L-M1C20M-② | LW1L-A1C20-②          | LW1L-A1C20V-② | LW1L-A1C20M-② |
|  |                  | 3PDT    | LW1L-M1C30-② | LW1L-M1C30V-② | —             | LW1L-A1C30-②          | LW1L-A1C30V-② | —             |
|  | Silver           | SPDT    | LW1L-M1C50-② | —             | —             | LW1L-A1C50-②          | —             | —             |
|  |                  | DPDT    | LW1L-M1C60-② | —             | LW1L-M1C60M-② | LW1L-A1C60-②          | —             | LW1L-A1C60M-② |
|  |                  | 3PDT    | LW1L-M1C70-② | —             | —             | LW1L-A1C70-②          | —             | —             |
| <br>Square    | Gold             | SPDT    | LW2L-M1C10-② | LW2L-M1C10V-② | —             | LW2L-A1C10-②          | LW2L-A1C10V-② | —             |
|  |                  | DPDT    | LW2L-M1C20-② | LW2L-M1C20V-② | LW2L-M1C20M-② | LW2L-A1C20-②          | LW2L-A1C20V-② | LW2L-A1C20M-② |
|  |                  | 3PDT    | LW2L-M1C30-② | LW2L-M1C30V-② | —             | LW2L-A1C30-②          | LW2L-A1C30V-② | —             |
|  | Silver           | SPDT    | LW2L-M1C50-② | —             | —             | LW2L-A1C50-②          | —             | —             |
|  |                  | DPDT    | LW2L-M1C60-② | —             | LW2L-M1C60M-② | LW2L-A1C60-②          | —             | LW2L-A1C60M-② |
|  |                  | 3PDT    | LW2L-M1C70-② | —             | —             | LW2L-A1C70-②          | —             | —             |
| <br>Mushroom | Gold             | SPDT    | LW1L-M3C10-② | LW1L-M3C10V-② | —             | LW1L-A3C10-②          | LW1L-A3C10V-② | —             |
|  |                  | DPDT    | LW1L-M3C20-② | LW1L-M3C20V-② | LW1L-M3C20M-② | LW1L-A3C20-②          | LW1L-A3C20V-② | LW1L-A3C20M-② |
|  |                  | 3PDT    | LW1L-M3C30-② | LW1L-M3C30V-② | —             | LW1L-A3C30-②          | LW1L-A3C30V-② | —             |
|  | Silver           | SPDT    | LW1L-M3C50-② | —             | —             | LW1L-A3C50-②          | —             | —             |
|  |                  | DPDT    | LW1L-M3C60-② | —             | LW1L-M3C60M-② | LW1L-A3C60-②          | —             | LW1L-A3C60M-② |
|  |                  | 3PDT    | LW1L-M3C70-② | —             | —             | LW1L-A3C70-②          | —             | —             |

- 1. In place of ②, specify the Lens Color Code from table below.
- 2. Lamps must be ordered separately for all illuminated pushbuttons.
- 3. For marking plate size and engraving area, see page A3-124.
- 4. For sub-assembly part numbers, see page A3-113.
- 5. For dimensions, see page A3-120.
- 5. For accessories, see page A3-119.

### Part Numbers: Lamps (not included in assemblies)

| Type  | Voltage       | Part Number |
|---|---------------|-------------|
| <br>LED          | 6V AC/DC±10%  | LSTD-6②     |
|   | 12V AC/DC±10% | LSTD-1②     |
|   | 24V AC/DC±10% | LSTD-2②     |
|   | 120V AC±10%   | LSTD-H2②    |
|   | 240V AC ±10%  | LSTD-M4②    |
| <br>Incandescent | 6.3V AC/DC    | IS-6        |
|   | 12V AC/DC     | IS-12       |
|   | 24V AC/DC     | IS-24       |

- 1. In place of ②, specify the LED Color Code.
- 2. The LED contains a current-limiting resistor and reverse polarity protection diode.

### ② Lens/LED Color Code

| Color  | Code |
|--------|------|
| Amber  | A    |
| Green  | G    |
| Red    | R    |
| Blue   | S    |
| White  | W    |
| Yellow | Y    |

## LED and Incandescent Illuminated Pushbuttons (Sub-Assembled)

Contact Block + Operator + Lamp + Lens = Completed Unit





A3

Switches & Pilot Devices

### Part Numbers: Operators

| Style    |  | Part Number |            |
|----------|--|-------------|------------|
|          |  | Momentary   | Maintained |
| Round    |   | LW1L-M0     | LW1L-A0    |
| Square   |   | LW2L-M0     | LW2L-A0    |
| Mushroom |  | LW1B-M0L    | LW1B-A0L   |

### Part Numbers: Lenses

| Type     |   | Part Number |
|----------|---|-------------|
|          |   | Flush       |
| Round    |  | LW1A-L1-②   |
| Square   |  | LW2A-L1-②   |
| Mushroom |  | LW1A-L3-②   |





In place of ②, specify Lens Color Code from table below.

### Part Numbers: Contact Blocks

| Appearance  | Contact Material | Contact | Part Number |          |         |
|---|------------------|---------|-------------|----------|---------|
|   |                  |         | Solder/Tab  | PC Board | Screw   |
|  | Gold             | SPDT    | LW-C10      | LW-C10V  | —       |
|   |                  | DPDT    | LW-C20      | LW-C20V  | LW-C20M |
|   |                  | 3PDT    | LW-C30      | LW-C30V  | —       |
|   | Silver           | SPDT    | LW-C50      | —        | —       |
|   |                  | DPDT    | LW-C60      | —        | LW-C60M |
|   |                  | 3PDT    | LW-C70      | —        | —       |

### Part Numbers: Lamps (not included in assemblies)

| Type  | Voltage       | Part Number |
|---|---------------|-------------|
| LED<br>          | 6V AC/DC±10%  | LSTD-6②     |
|   | 12V AC/DC±10% | LSTD-1②     |
|   | 24V AC/DC±10% | LSTD-2②     |
|   | 120V AC±10%   | LSTD-H2②    |
|   | 240V AC ±10%  | LSTD-M4②    |
| Incandescent<br> | 6.3V AC/DC    | IS-6        |
|   | 12V AC/DC     | IS-12       |
|   | 24V AC/DC     | IS-24       |

### ② LED/Lens Color Code

| Color  | Code |
|--------|------|
| Amber  | A    |
| Green  | G    |
| Red    | R    |
| Blue   | S    |
| White  | W    |
| Yellow | Y    |



- In place of ②, specify the LED Color Code.
- The LED contains a current-limiting resistor and reverse polarity protection diode.

## LED and Incandescent Pilot Lights (Assembled)

### Part Numbers: LW1P/LW2P Pilot Lights



A3

Switches & Pilot Devices

| Type                           | Style  | Part Number |              |            |
|--------------------------------|--|-------------|--------------|------------|
|                                |  | Solder/Tab  | PC Board     | Screw      |
| Removable Terminal Pilot Light | Round<br>   | —           | LW1P-1C00V-② | —          |
|                                | Square<br>  | —           | LW2P-1C00V-② | —          |
| Unibody Pilot Light            | Round<br>   | LW1P-10-②   | —            | LW1P-10M-② |
|                                | Square<br> | LW2P-10-②   | —            | LW2P-10M-② |

-  1. In place of ②, specify the Lens Color Code from table below.  
 2. For marking plate size and engraving area, see page A3-124.  
 3. Lamps must be ordered separately, see table below.  
 4. For sub-assembly part numbers, see page A3-115.  
 5. For dimensions, see page A3-120.  
 6. For accessories, see page A3-119.

### Part Numbers: Lamps (not included in assemblies)

| Type  | Voltage       | Part Number |
|---|---------------|-------------|
| LED<br>          | 6V AC/DC±10%  | LSTD-6②     |
|   | 12V AC/DC±10% | LSTD-1②     |
|   | 24V AC/DC±10% | LSTD-2②     |
|   | 120V AC±10%   | LSTD-H2②    |
|   | 240V AC ±10%  | LSTD-M4②    |
| Incandescent<br> | 6.3V AC/DC    | IS-6        |
|   | 12V AC/DC     | IS-12       |
|   | 24V AC/DC     | IS-24       |

### ② Lens/LED Color Code

| Color  | Code |
|--------|------|
| Amber  | A    |
| Green  | G    |
| Red    | R    |
| Blue   | S    |
| White  | W    |
| Yellow | Y    |

-  1. In place of ②, specify the LED Color Code.  
 2. The LED contains a current-limiting resistor and reverse polarity protection diode.

## LED and Incandescent Pilot Lights (Sub-Assembled)

A3



Switches & Pilot Devices

Removable Terminal\* + Operator + Lamp + Lens = Completed Unit



\* Removable terminals are applicable for PCB terminated types only.

### Part Numbers: Pilot Light Operators

| Style   | Termination |          |          |
|---|-------------|----------|----------|
|   | Solder      | PC Board | Screw    |
| Round<br>  | LW1P-00     | LW1P-0 † | LW1P-00M |
| Square<br> | LW2P-00     | LW2P-0 † | LW2P-00M |



- † Requires LW-C00V removable terminals in addition to operator.
- Solder and screw terminals are unibody design (they do not use a removable terminal block).



### Part Numbers: Lenses

| Type  | Part Number |
|---|-------------|
| Round<br>  | LW1A-P1-②   |
| Square<br> | LW2A-P1-②   |



In place of ②, specify Lens Color Code.

### Part Numbers: Lamps (not included in assemblies)

| Type  | Voltage       | Part Number |
|---|---------------|-------------|
| LED<br>          | 6V AC/DC±10%  | LSTD-6②     |
|   | 12V AC/DC±10% | LSTD-1②     |
|   | 24V AC/DC±10% | LSTD-2②     |
|   | 120V AC±10%   | LSTD-H2②    |
|   | 240V AC ±10%  | LSTD-M4②    |
| Incandescent<br> | 6.3V AC/DC    | IS-6        |
|   | 12V AC/DC     | IS-12       |
|   | 24V AC/DC     | IS-24       |



- In place of ②, specify the LED Color Code.
- The LED contains a current-limiting resistor and reverse polarity protection diode.



### ② LED/Lens Color Code

| Color  | Code |
|--------|------|
| Amber  | A    |
| Green  | G    |
| Red    | R    |
| Blue   | S    |
| White  | W    |
| Yellow | Y    |





## Selector and Keylock Switches (Assembled)

### Part Numbers: LW1S Selector Switches

| Style  | Position   | Contact Material | Contact | Part Number |           |           |
|--|--|------------------|---------|-------------|-----------|-----------|
|  |  |                  |         | Solder/Tab  | PC Board  | Screw     |
| Round<br> | 90° 2-position maintained<br> | Gold             | SPDT    | LW1S-2C1    | LW1S-2C1V | —         |
|  |  |                  | DPDT    | LW1S-2C2    | LW1S-2C2V | LW1S-2C2M |
|  |  |                  | 3PDT    | LW1S-2C3    | LW1S-2C3V | —         |
|  |  | Silver           | SPDT    | LW1S-2C5    | —         | —         |
|  |  |                  | DPDT    | LW1S-2C6    | —         | LW1S-2C6M |
|  |  |                  | 3PDT    | LW1S-2C7    | —         | —         |
|  | 45° 3-position maintained<br> | Gold             | DPDT    | LW1S-3C2    | LW1S-3C2V | LW1S-3C2M |
|  |  |                  | 3PDT    | LW1S-3C3    | LW1S-3C3V | —         |
|  |  | Silver           | DPDT    | LW1S-3C6    | —         | LW1S-3C6M |
|  |  |                  | 3PDT    | LW1S-3C7    | —         | —         |



-  1. Knob color: Black; Directional Indication Color: White  
 2. For contact operation, see next page.  
 3. For sub-assembly part numbers, see page A3-118.

### Part Numbers: LW1K Keylock Selector Switches

| Style   | Position   | Contact Material | Contact | Part Number |            |            |
|---|--|------------------|---------|-------------|------------|------------|
|   |  |                  |         | Solder/Tab  | PC Board   | Screw      |
| Round<br> | 90° 2-position maintained<br>   | Gold             | SPDT    | LW1K-2C1A   | LW1K-2C1VA | —          |
|   |  |                  | DPDT    | LW1K-2C2A   | LW1K-2C2VA | LW1K-2C2MA |
|   |  |                  | 3PDT    | LW1K-2C3A   | LW1K-2C3VA | —          |
|   |  | Silver           | SPDT    | LW1K-2C5A   | —          | —          |
|   |  |                  | DPDT    | LW1K-2C6A   | —          | LW1K-2C6MA |
|   |  |                  | 3PDT    | LW1K-2C7A   | —          | —          |
|   | 45° 3-position maintained<br> | Gold             | DPDT    | LW1K-3C2A   | LW1K-3C2VA | LW1K-3C2MA |
|   |  |                  | 3PDT    | LW1K-3C3A   | LW1K-3C3VA | —          |
|   |  | Silver           | DPDT    | LW1K-3C6A   | —          | LW1K-3C6MA |
|   |  |                  | 3PDT    | LW1K-3C7A   | —          | —          |

-  1. Every key selector uses an identical key.  
 2. The key is removable in all positions.  
 3. If a different configuration is required, contact an IDEC representative for more information.  
 4. For contact operation, see next page.  
 5. For sub-assembly part numbers, see page A3-118.

### Part Numbers: LW1F LED and Incandescent Illuminated Selector Switches

| Style  | Position   | Contact Material | Contact | Part Numbers |              |              |
|--|--|------------------|---------|--------------|--------------|--------------|
|  |  |                  |         | Solder/Tab   | PC Board     | Screw        |
| Round<br> | 90° 2-position maintained<br> | Gold             | SPDT    | LW1F-2C10-②  | LW1F-2C10V-② | —            |
|  |  |                  | DPDT    | LW1F-2C20-②  | LW1F-2C20V-② | LW1F-2C20M-② |
|  |  |                  | 3PDT    | LW1F-2C30-②  | LW1F-2C30V-② | —            |
|  |  | Silver           | SPDT    | LW1F-2C50-②  | —            | —            |
|  |  |                  | DPDT    | LW1F-2C60-②  | —            | LW1F-2C60M-② |
|  |  |                  | 3PDT    | LW1F-2C70-②  | —            | —            |
|  | 45° 3-position maintained<br> | Gold             | DPDT    | LW1F-3C20-②  | LW1F-3C20V-② | LW1F-3C20M-② |
|  |  |                  | 3PDT    | LW1F-3C30-②  | LW1F-3C30V-② | —            |
|  |  | Silver           | DPDT    | LW1F-3C60-②  | —            | LW1F-3C60M-② |
|  |  |                  | 3PDT    | LW1F-3C70-②  | —            | —            |

-  1. In place of ②, specify color code. See previous page for color codes.  
 2. Lamps must be ordered separately for all illuminated pushbuttons. See previous page.  
 3. For contact operation, see next page.  
 4. For sub-assembly part numbers, see page A3-118.

## Contact Operations

### Contact Operation: Selector and Keylock Switches

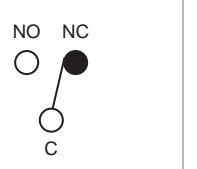
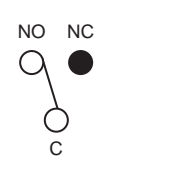
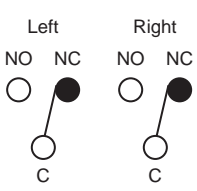
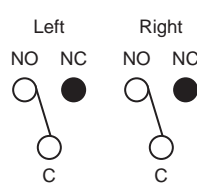
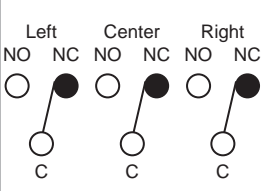
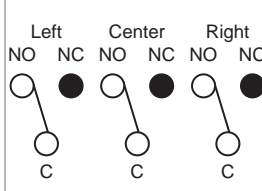
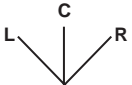
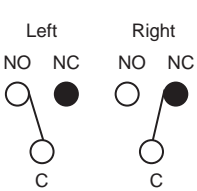
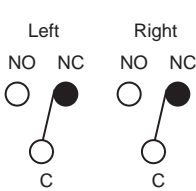
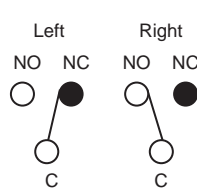
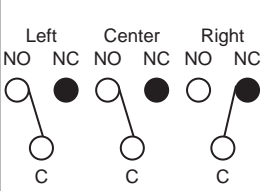
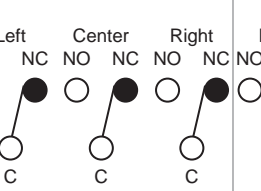
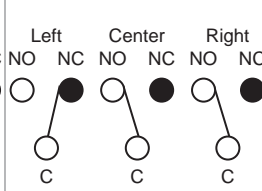
| Position   | Contact | Operator Position and Contact Position (Top View)                                   |  |  |
|--|---------|---|--|--|
|  |         | Left  | Center   | Right  |
|  <p>90°<br/>2-Position<br/>Maintained</p>   | SPDT    |    | -  |   |
|  | DPDT    |    | -  |   |
|  | 3PDT    |    | -  |    |
|  <p>45°<br/>3-Position<br/>Maintained</p> | DPDT    |   |    |  |
|  | 3PDT    |  |  |  |

### Terminal Arrangements (Bottom View): LW□L and LW□B Pushbuttons

3 pole illuminated

2 pole illuminated

3 pole non-illuminated

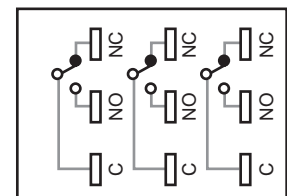
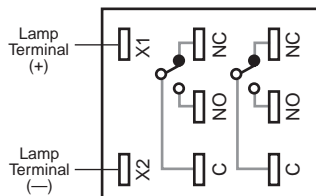
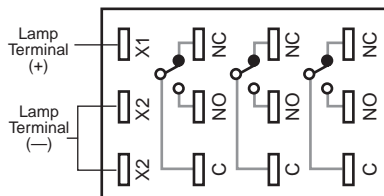

SPDT has C, NO and NC only on the center. DPDT has C, NO, and NC only on the right and left.



SPDT has C, NO and NC only on the right. DPDT has C, NO, and NC only on the right and center.

## Selectors and Key Switches (Sub-Assembled)

A3

Switches & Pilot Devices



\*Lens for illuminated units only

### Part Numbers: Operators

| Unit                            | Position   | Part Number |
|---------------------------------|------------|-------------|
| Non-Illuminated Selector Switch | 2-position | LW1S-2Y     |
|                                 | 3-position | LW1S-3Y     |
| Key Switch                      | 2-position | LW1K-2A     |
|                                 | 3-position | LW1K-3A     |
| Illuminated Selector Switch     | 2-position | LW1F-20*    |
|                                 | 3-position | LW1F-30*    |

\* Lens must be purchased separately for illuminated units.

### Part Numbers: Knob (Lens)

| Style                         | Part Number |
|-------------------------------|-------------|
| Illuminated Selector Switches | LW1A-F-②    |
|                               |             |



In place of ②, specify LED/Lens Color Code from table below.

### Part Numbers: Contact Blocks

| Appearance | Style                             | Contact Material | Contact | Part Number |          |         |
|------------|-----------------------------------|------------------|---------|-------------|----------|---------|
|            |                                   |                  |         | Solder/Tab  | PC Board | Screw   |
|            | Illuminated Selector Switches     | Gold             | SPDT    | LW-C10      | LW-C10V  | —       |
|            |                                   |                  | DPDT    | LW-C20      | LW-C20V  | LW-C20M |
|            |                                   |                  | 3PDT    | LW-C30      | LW-C30V  | —       |
|            |                                   | Silver           | SPDT    | LW-C50      | —        | —       |
|            |                                   |                  | DPDT    | LW-C60      | —        | LW-C60M |
|            |                                   |                  | 3PDT    | LW-C70      | —        | —       |
|            | Non-Illuminated Selector Switches | Gold             | SPDT    | LW-C1       | LW-C1V   | —       |
|            |                                   |                  | DPDT    | LW-C2       | LW-C2V   | LW-C2M  |
|            |                                   |                  | 3PDT    | LW-C3       | LW-C3V   | —       |
|            |                                   | Silver           | SPDT    | LW-C5       | —        | —       |
|            |                                   |                  | DPDT    | LW-C6       | —        | LW-C6M  |
|            |                                   |                  | 3PDT    | LW-C7       | —        | —       |

### Part Numbers: Lamps (not included in assemblies)

| Type         | Voltage       | Part Number |
|--------------|---------------|-------------|
| LED          | 6V AC/DC±10%  | LSTD-6②     |
|              | 12V AC/DC±10% | LSTD-1②     |
|              | 24V AC/DC±10% | LSTD-2②     |
|              | 120V AC±10%   | LSTD-H2②    |
|              | 240V AC ±10%  | LSTD-M4②    |
| Incandescent | 6.3V AC/DC    | IS-6        |
|              | 12V AC/DC     | IS-12       |
|              | 24V AC/DC     | IS-24       |















### ② LED/Lens Color Code

| Color  | Code |
|--------|------|
| Amber  | A    |
| Green  | G    |
| Red    | R    |
| Blue   | S    |
| White  | W    |
| Yellow | Y    |

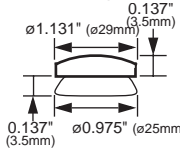

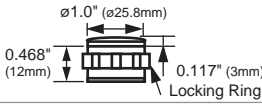
- In place of ②, specify the LED Color Code.
- The LED contains a current-limiting resistor and reverse polarity protection diode.

## Accessories — LW Series

| Style  | Description/Usage  | Part Number   |
|--|--|---|
| Ring Wrench (optional)    | 1. Metallic tool used for tightening the plastic locking ring when installing the LW series on a panel.<br>2. Tightening torque should not exceed 1.2N-m (12 kgf-cm) when tightening a locking ring.   | LW9Z-T1   |
| Lamp Holder Tool (optional)   | Rubber tool used for replacing incandescent or LED lamps installed in illuminated switches and pilot lights and pilot lights   | OR-55   |
| Terminal Cover (for solder tab terminal)                            | Nylon cover for pushbuttons and selectors with solder terminals snaps onto contact block.<br>(Insert the lead wires through terminal cover holes before wiring.)   | LW-VL2  |
| Terminal Cover (for screw terminal)                                 | Nylon cover for pushbuttons and selectors for screw terminals snaps onto contact block.<br>(Insert the lead wires through terminal cover holes before wiring.)   | LW-VL2M   |
| Terminal Cover (for unibody pilot light with solder tab terminal)  | Nylon cover for unibody pilot lights with solder terminals.  | LW-PVL  |
| Terminal Cover (for unibody pilot light with screw terminal)      | Nylon cover for unibody pilot lights with screw terminals.   | LW-PVLM   |
| Rubber Mounting Hole Plug   | Black rubber plug fills unused 22mm panel cutouts.   | OB-31   |
| Metallic Mounting Hole Plug                                       | 1. Used for plugging unnecessary mounting holes in the panel. Tighten the attached locking ring to a torque of 1.2N-m (12kgf-cm) maximum<br>2. Degree of Protection: IP66  | LW9Z-BM   |
| Replacement Marking Plates                                        | White plastic engraving plate for use on all illuminated units (included in each lens).<br>May be used to capture printed mylar insert (not supplied by IDEC) under lens face.   | LW9Z-P1-W (round)<br>LW9Z-P2-W (square)<br>ALW3B (mushroom) |
| Anti-Rotation Ring    | Prevents rotation of switches in panel.<br>(included with all selector and key switches only)  | LW9Z-L  |
| Replacement Keys    | One pair of keys. (#231)   | KG9Z-SK   |
| Replacement Locking Ring    | Use to secure operator to panel.<br>(included with all assembled switches and operators)   | LW9Z-LN   |

A3

Switches & Pilot Devices



For replacement lamps, see previous page.

**Dimensions: Pushbuttons**

**LW□L & LW□B: Illuminated & Non-Illuminated Pushbuttons**

**A3**  
**Switches & Pilot Devices**

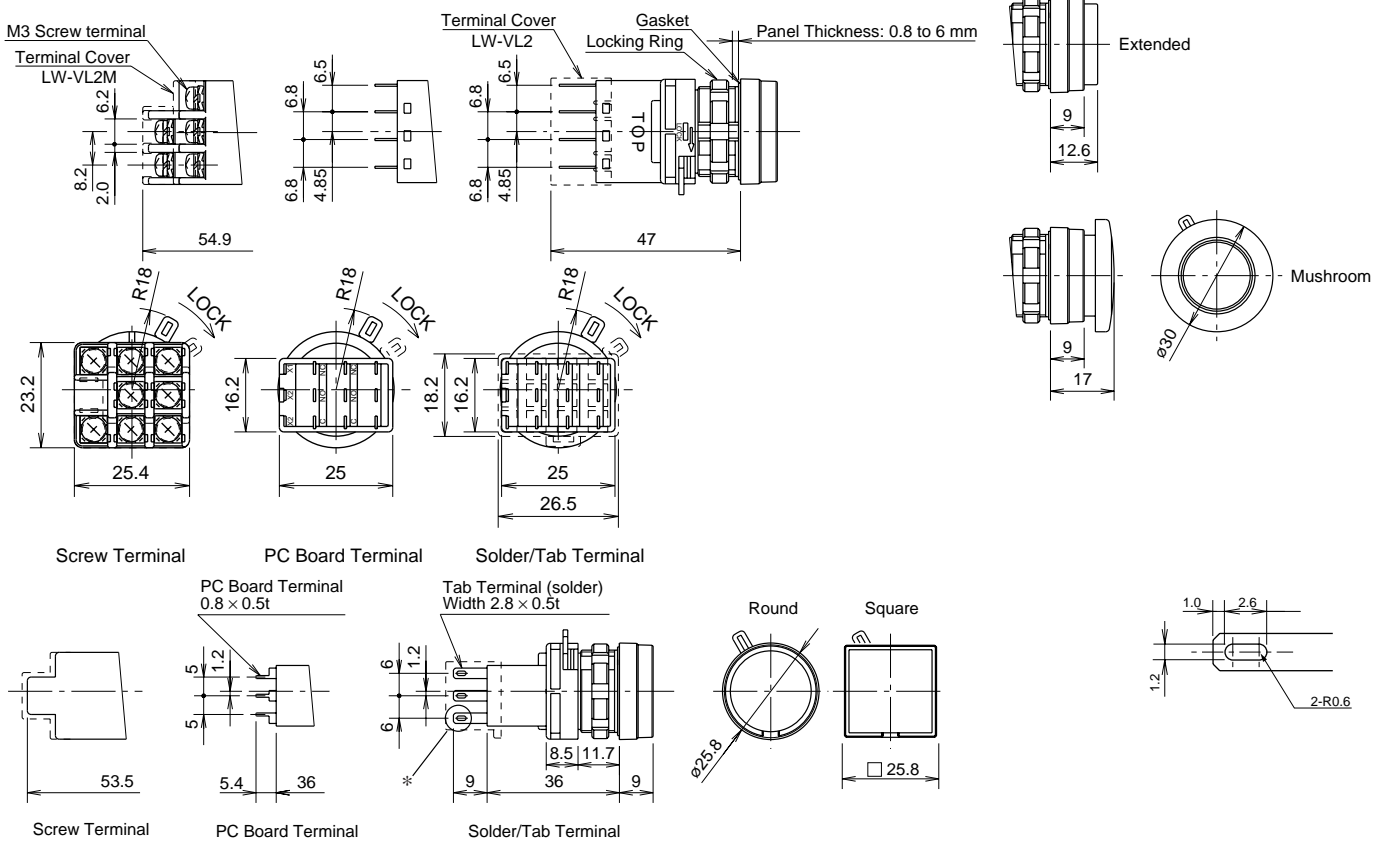
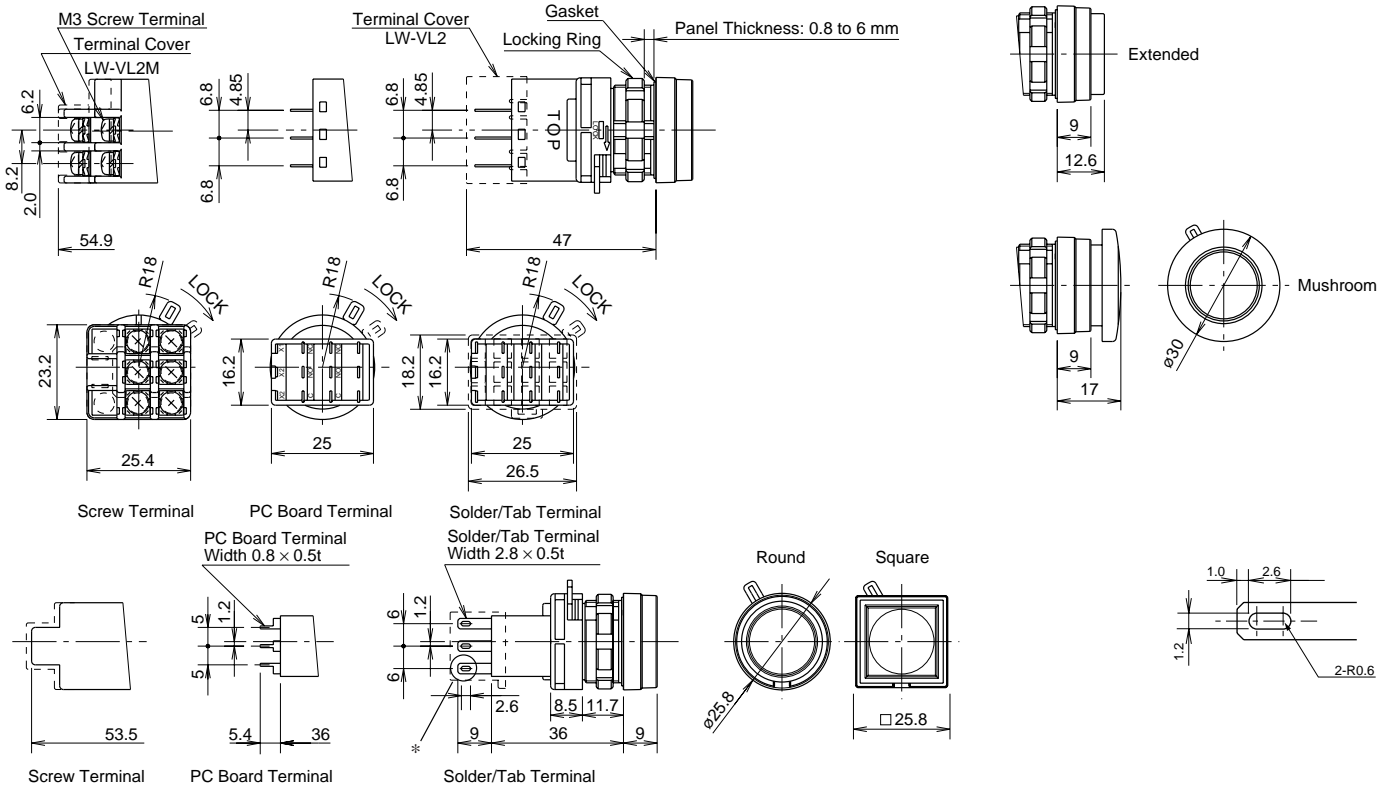

## Dimensions: Pilot Lights

### LW1P/LW2P Pilot Lights

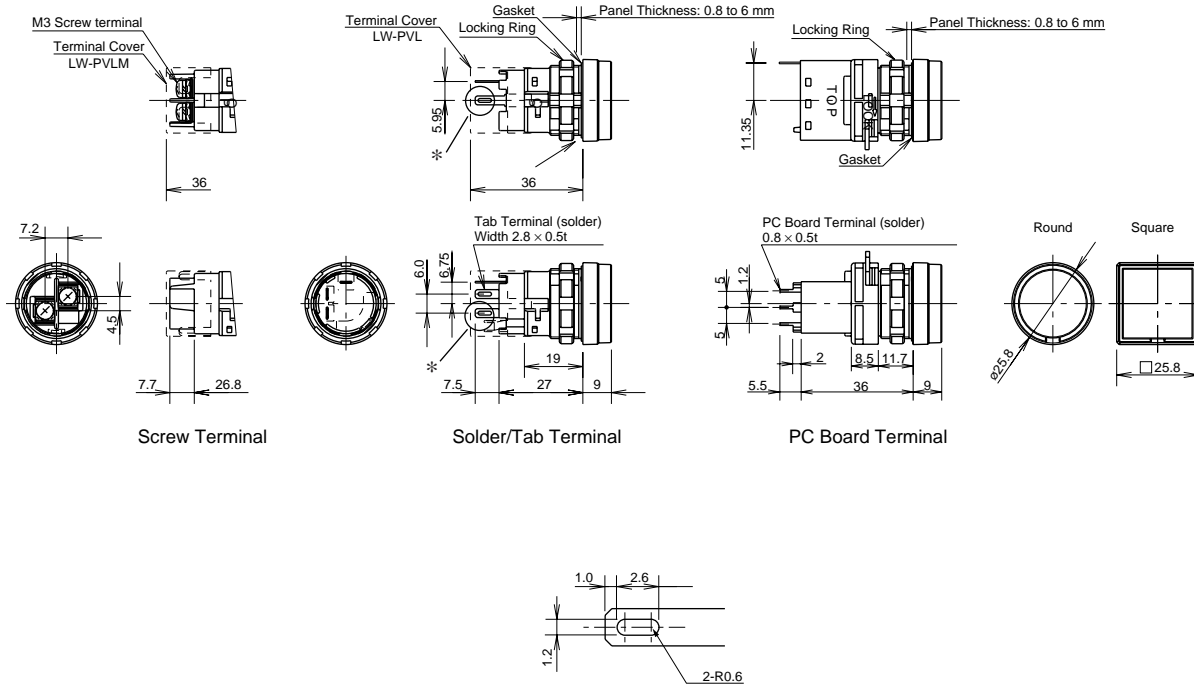

## Dimensions: Selector and Keylock Switches

### LW1S and LW1K Selector and Keylock Switches

A3

Switches & Pilot Devices

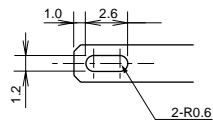
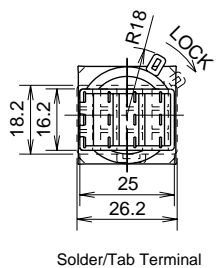
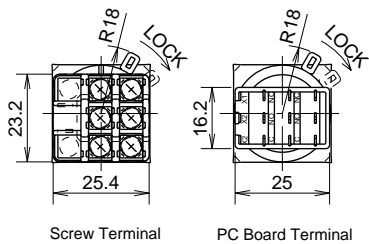
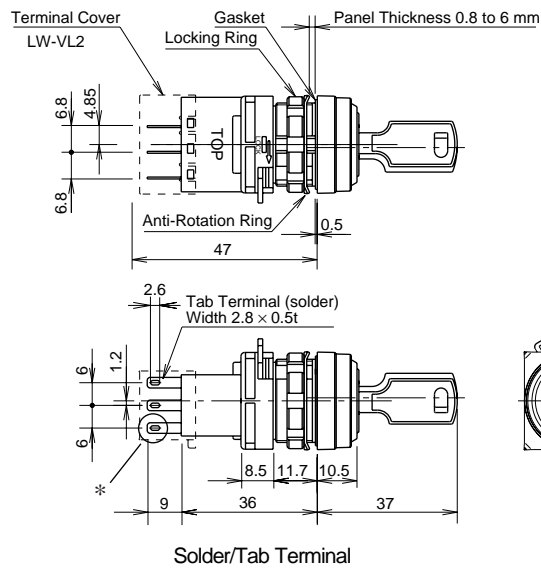
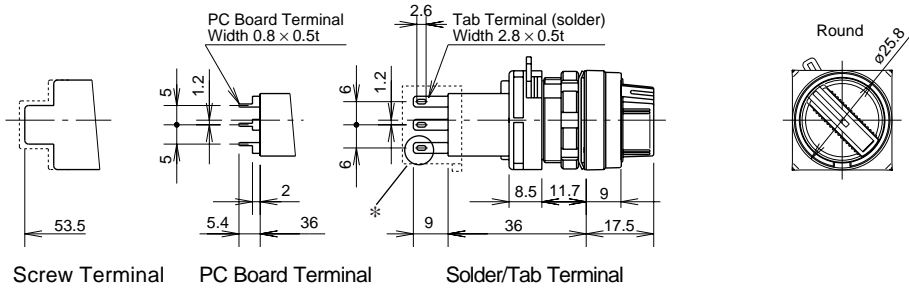
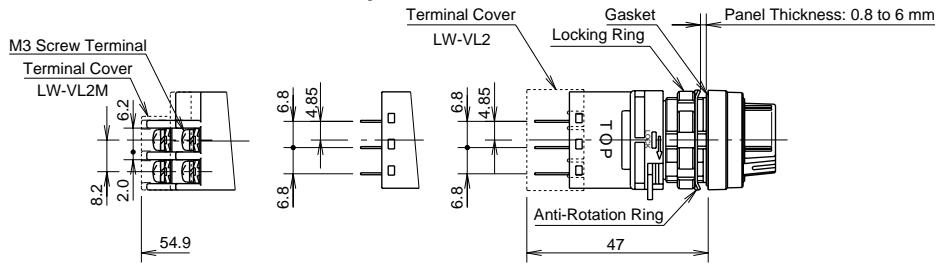

## Dimensions: Selector and Keylock Switches, continued and Layouts

### LW1F LED and Incandescent Illuminated Selector Switches

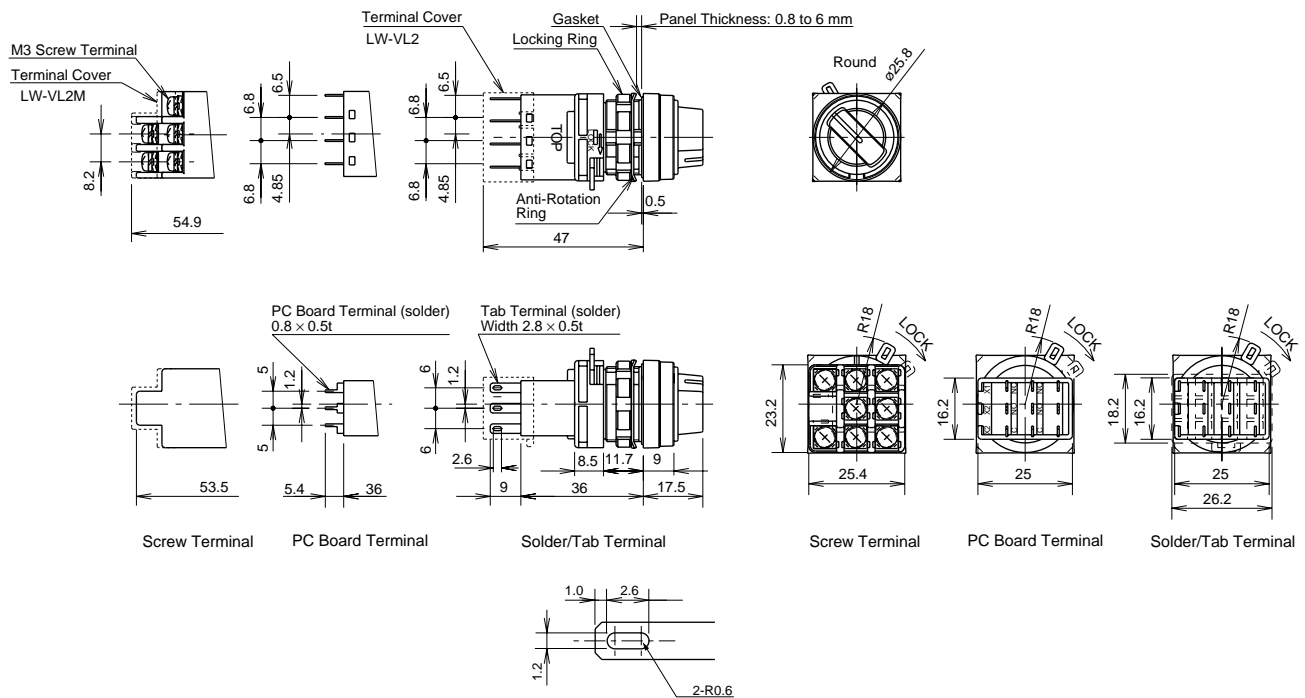

### Layouts

LW□L PC Board Drilling Layout  
PC Board Terminal  
Bottom View

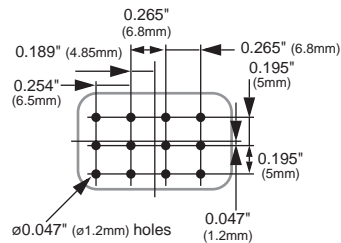

LW□B PC Board Drilling Layout  
PC Board Terminal  
Bottom View

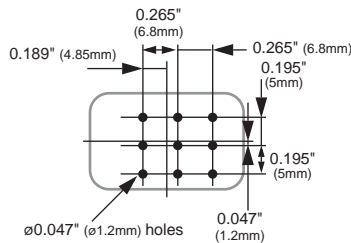

Pilot Lights  
PC Board Drilling Layout  
PC Board Terminal  
Bottom View

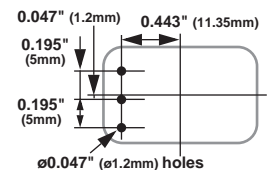

### Mounting Hole Layout

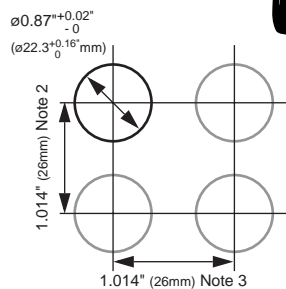

- When determining mounting centerlines, allow for easy operation.
- Mushroom (Ø 1.17" (Ø 30mm)) = 1.248" (32mm)  
 Tab terminal = 1.014" (26mm) (with/without terminal cover)  
 PC board terminal = 1.014" (26mm)  
 Screw terminal = 1.56" (40mm)
- Mushroom (Ø 1.17" (Ø 30mm)) = 1.248" (32mm)  
 Tab terminal = 1.053" (27mm) (with terminal cover)  
 Tab terminal = 1.014" (26mm) (without terminal cover)  
 PC board terminal = 1.014" (26mm)  
 Screw terminal = 1.014" (26mm)



## Instructions — LW Series

### Replacement of Lens & Marking Plate

A3

#### Removing

1. Remove the operator (lens, marking plate, and lens holder) by inserting a screwdriver into the recess of the lens through the bezel.



2. Remove the marking plate by pushing the lens from the rear to disengage the latches between the lens and the lens holder, using the screwdriver as shown below.



The translucent filter in the lens holder can not be removed because this filter is sealed to make the unit waterproof and oiltight.

#### Installing

For round lens types, place the marking plate on the lens holder with the anti-rotation projection engaged and press the lens onto the lens holder to engage the latches. For square lens types, insert the marking plate into the lens, and press the lens onto the lens holder to engage the latches. Pay attention to the orientation of the marking plate.

Pay attention to the orientation of the marking plate.

For Round Lens

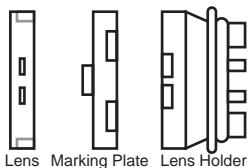

For Square Lens

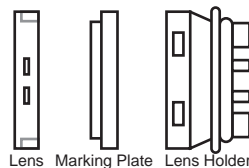

### Replacement of Lamps

Lamps can be replaced using the lamp holder tool (OR-55) from the front of the panel. Also by removing the contact block from the operator unit, the lamp can be replaced.

#### Replacement of Lamps from the Front of the Panel.

##### (How to Remove)

1. Push and turn the lamp counterclockwise using the side A of the lamp holder tool, and the lamp and the lamp holder can be removed.



##### (How to Install)

1. Insert the lamp into the lamp holder tool and hold the lamp as in the following illustration.

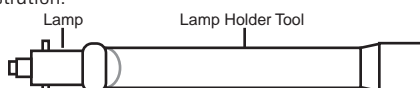

2. Place the insertion guide of the lamp and the groove in the operator unit in

the same direction. Then push the lamp lightly and turn it clockwise.

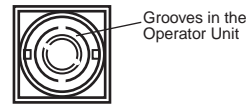

#### Replacement of Lamps by Removing the Contact Block

The lamp can be replaced by removing the contact block without using the lamp holder tool.

### Marking Plates & Films

For LW series illuminated pushbuttons and pilot lights, legends and symbols can be engraved on marking plates, or printed mylar can be inserted under the lens for labelling purposes.

#### Marking Plate and Marking Film Size

| Lens Style   | Round Lens | Square Lens |
|--|------------|-------------|
| <b>Built-in Marking Plate</b>  |            |             |
| Engraving must be made on the engraving area within 0.02" (0.5mm) deep.<br>The marking plate is made of white acrylic resin.   |            |             |
| <b>Applicable Marking Film</b>   |            |             |
| Mylar for printing labels are not included and must be provided and printed by user.<br>Two 0.004" (0.1mm)-thick films or one 0.008" (0.2mm)-thick film can be installed in the lens.<br>Recommended marking film: Mylar |            |             |

#### Insertion Order of Marking Plate & Film

For Round Lens

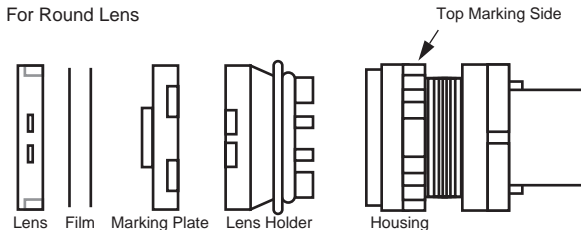

#### Insertion Order of Marking Plate & Film.

For Square Lens

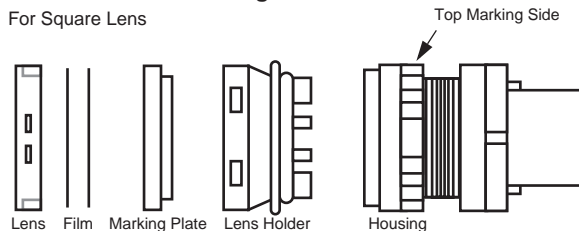

1. Mylar is not included.

2. Pay attention to the orientation of marking plate.

## Instructions con't

### Panel Mounting

Remove the contact block from the operator. Insert the operator into the panel cut-out from the front, then install the contact block to the operator.

#### Removing the Contact Block

Turn the locking lever on the contact block in the direction opposite to the arrow on the housing. Then the contact block can be removed.

#### Installing the Contact Block

Insert the contact block, with the TOP markings on the contact block and the operator placed in the same direction. Then lock the units, turning the locking lever in the direction of the arrow.



#### Notes on Mounting

Use the optional Ring Wrench (LW9Z-T1) to mount the operator onto a panel. Tightening torque should not exceed 1.2N-m (12 kgf-cm). Do not use pliers. Excessive tightening will damage the locking ring.

### Wiring

1. Solder the terminals within 20W/5 seconds or 260°C/3 seconds without exerting external force to the terminals. While soldering, do not touch the soldering iron to the housing. While wiring, prevent tension from being applied to the terminals. Do not bend or raise the terminals, nor exert excessive force to terminals.
2. Use a non-corrosive resin liquid flux.

#### Collective Mounting

As the locking lever can be turned easily from the rear of the units using a screwdriver, the contact blocks can be removed even when mounted collectively.

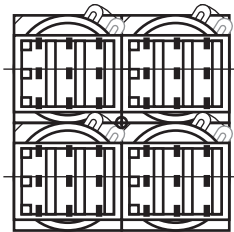

### Notes for Terminal Cover

#### (Solder/Tab Terminal)

Insert the terminal cover into the contact block with the TOP markings on the contact block and the terminal cover in the same direction.



When wiring, insert the lead wires into the terminal cover holes before wiring.



#### Notes for Wiring

When installing a terminal cover onto the solder/tab terminal contact block, solder the inside of lamp terminal (toward the switch terminals) and wire.

#### (Screw Terminal Type)

Install a terminal cover to the control unit before wiring.



1. After wiring, terminal covers cannot be installed.
2. When terminal covers are used, round crimping terminals cannot be used.

### Connection

Positive-lock connector and easy-lock connector are applicable to tab terminals.

### Single Board Mounting

Mounting the switches and pilot lights on one PC board offers the following features.

1. Reduced installation labor, easy wiring, space saving, and standardization.
2. Since the contact blocks on the PC board can be removed easily using a locking lever, the LW series switches and pilot lights are easy to maintain.
3. Because the LW series switches and pilot lights require no studs for fastening the control unit to a PC board, special preparation of operation panel is not needed.

For details on one board mounting, contact IDEC.



### Light Touch And High Reliability

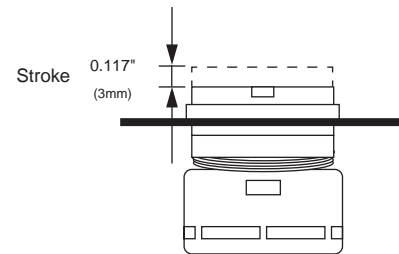

### Operating-force Snap Switching Mechanism

