



The CT Series combines a delay-on-make and delay-on-break time delay into one unit and may be used to control fan delays in heating and/or cooling equipment. The CT includes bypass circuitry to allow it to operate with cooling anticipators ≥ 3000 ohms. It is designed to operate in 24VAC control circuits. Several CT modules may be combined to provide sequencing on of any number of loads and sequencing off of the same loads, such as electric heating elements.

Operation (Delay-on-Make/Delay-on-Break):

Forced Air Heating or Air Conditioning (as shown): When the thermostat closes, the compressor relay is immediately energized. At the end of a fixed delay-on-make delay (T1), the fan relay is energized. When the thermostat opens, the compressor relay is de-energized and the delay-on-break delay is initiated. On completion of the fixed delay-on-break delay (T2) the fan relay is de-energized. If the thermostat is reclosed during the delay-on-break delay, the delay-on-break delay is reset and the fan relay remains energized. If the thermostat is closed when input voltage is applied, the delay-on-make delay (T1) begins as normal.

Reset: Removing input voltage resets the output and time delays.

For more information see:

Appendix B, page 165, Figure 1 for dimensional drawing.

Function:

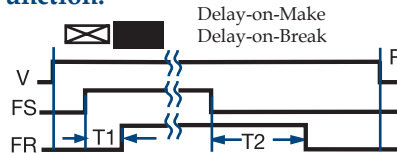

- V = Voltage
- R = Reset
- FS = Fan Switch
- FR = Fan Relay
- T1 = Delay-on-Make
- T2 = Delay-on-Break

Connection:

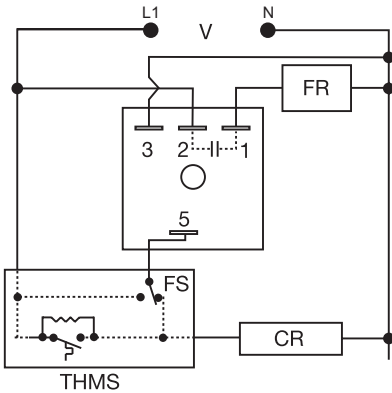

CR = Compressor Relay
THMS = Wall Thermostat

Features:

- Delay-on-make and delay-on-break in one unit
- Use for fan delays in heating or cooling equipment
- Use for multiple load sequencing
- 24VAC operation
- Factory fixed delays from 1 - 600s in 1s increments

Approvals:

Auxiliary Products:

- **Female quick connect:** P/N: P1015-64 (AWG 14/16)
- **Mounting bracket:** P/N: P1023-6
- **Quick connect to screw adaptor:** P/N: P1015-18
- **DIN rail:** P/N: C103PM (Al)
- **DIN rail adaptor:** P/N: P1023-20

Available Models:

CT1S12	CT1S90
CT1S30	CT30S1
CT1S300	CT45S45
CT1S45	CT5S300
CT1S8	

If desired part number is not listed, please call us to see if it is technically possible to build.

Order Table:

<u>CT</u>	<u>X</u>	<u>X</u>
	Delay-on-Make (fixed)	Delay-on-Break (fixed)
	Specify time in seconds from 1 - 600s followed by (S)	Specify time in seconds from 1 - 600s

Specifications

Time Delay	
Type	Microcontroller
Range	1 - 600s
Repeat Accuracy	$\pm 5\%$
Tolerance (Factory Calibration)	$\pm 20\%$
Recycle Time	≤ 300 ms
Input	
Voltage	24VAC
Tolerance	$\pm 15\%$
AC Line Frequency	50/60 Hz
Output	
Type	Solid state
Form	NO
Rating	0.75A steady state, 5A inrush at 55°C
Voltage Drop	≈ 1.25 V

Protection	
Circuitry	Encapsulated
Dielectric Breakdown	≥ 2000 V RMS terminals to mounting surface
Insulation Resistance	≥ 100 M Ω
Mechanical	
Mounting	Surface mount with one #10 (M5 x 0.8) screw
Dimensions	.2 x 2 x 1.21 in. (50.8 x 50.8 x 30.7 mm)
Termination	.025 in. (6.35 mm) male quick connect terminals
Environmental	
Operating / Storage Temperature	-40° to 70°C / -40° to 85°C
Humidity	95% relative, non-condensing
Weight	≈ 2.4 oz (68 g)
Thermostat	Anticipator Resistor: ≥ 3000 Ω

Appendix B - Dimensional Drawings

FIGURE 1

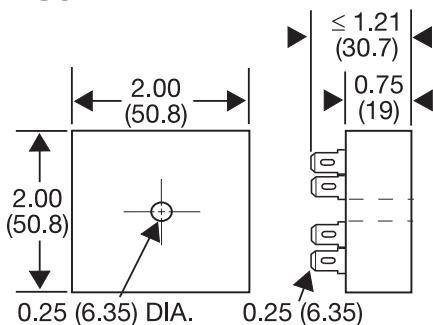

0.25 (6.35) DIA. 0.25 (6.35)

CT; ESD5; ESDR; FS100; FS200; FS300; KR3; KR9; KRDB; KRDI; KRDM; KRDR; KRDS; KRPD; KRPS; KSD1; KSD2; KSD3; KSD4; KSDB; KSDR; KSDS; KSDU; KSPD; KSPS; KSPU; KVM; T2D; TA; TAC1; TAC4; TDU; TDUB; TDUI; TDUS; TL; TMV8000; TS1; TS2; TS4; TS6; TSB; TSD1; TSD2; TSD3; TSD4; TSD6; TSD7; TSDB; TSDR; TSDS; TSS; TSU2000

FIGURE 2

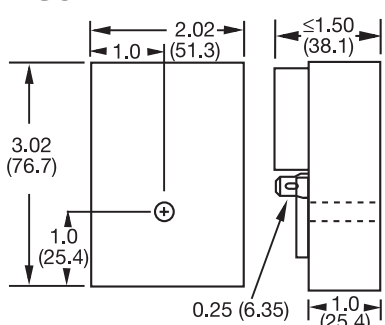

HLV; HRD3; HRD9; HRDB; HRDI; HRDM; HRDR; HRDS; HRID; HRIS; HRIU; HRPD; HRPS; HRPD; HRPU; HRV; RS

FIGURE 3

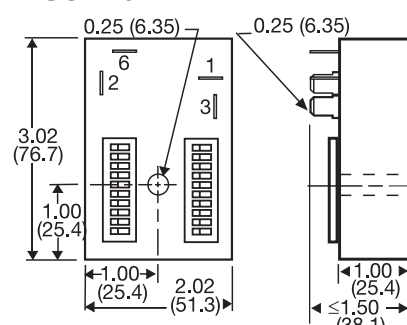

HSPZ

FIGURE 4

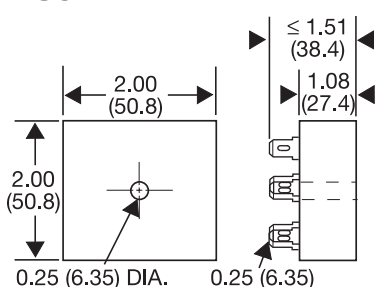

FA; FS; FSU1000*; NHPD; NHPS; NHPU; NLF1*; NLF2*; PHS*; PTHF*; SIR1; SIR2; SLR1*; SLR2*; TH1; TH2; THC; THD1; THD2; THD3; THD4; THD7; THDB; THDM; THDS; THS

*If unit is rated @ 1A, see Figure 1

FIGURE 5

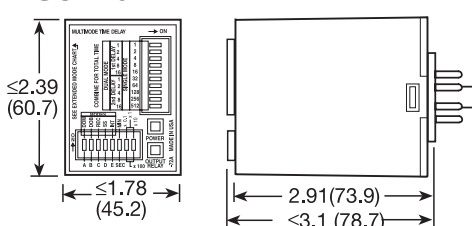

TRDU

FIGURE 6

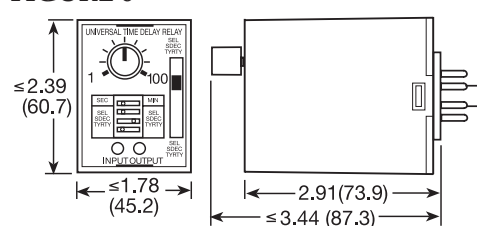

TRU

FIGURE 7

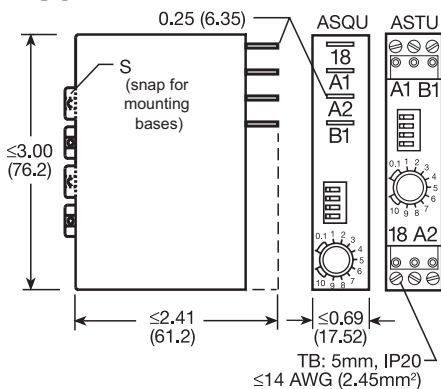

ASQU; ASTU; DSQU; DSTU

FIGURE 8

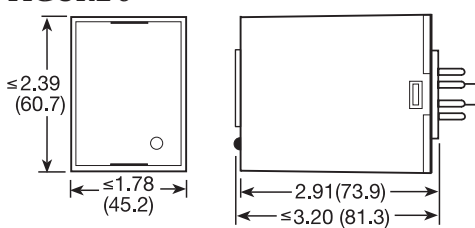

PLM; PLR; TDB; TDBH; TDBL; TDI; TDIH; TDIL; TDM; TDMB; TDMH; TDML; TDR; TDS; TDSH; TDSL

FIGURE 9

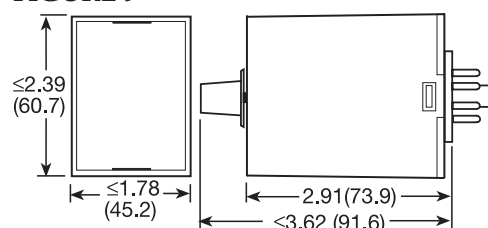

FS500; PRLB; PRM; PRLS; TRB; TRM; TRS

FIGURE 10

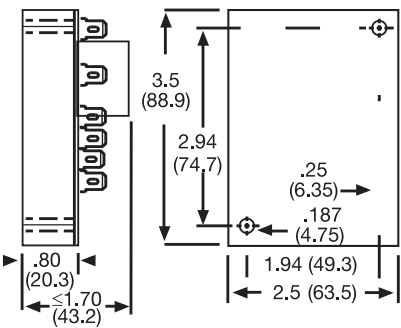

ERD3; ERDI; ERDM

FIGURE 11

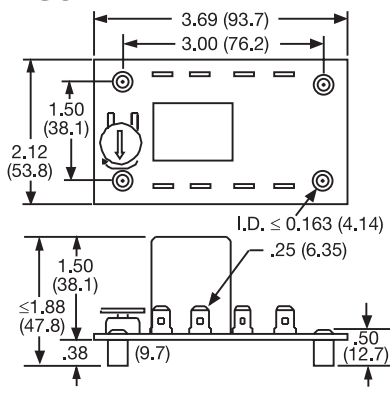

ORB; ORM; ORS

FIGURE 12

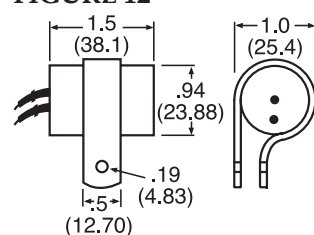

FS100; FS400

inches (millimeters)