

MODELS T16 & P16 - TEMPERATURE/PROCESS CONTROLLERS



- PID CONTROL WITH REDUCED OVERSHOOT
- T16 ACCEPTS TC AND RTD
- P16 ACCEPTS 0-10 V AND 0/4-20 mA SIGNALS
- ON DEMAND AUTO-TUNING OF PID SETTINGS
- DC ANALOG OUTPUT (OPTIONAL)
- USER PROGRAMMABLE FUNCTION BUTTON
- PC OR FRONT PANEL PROGRAMMING
- PC CONFIGURABLE WITH TP16KIT



UL Recognized Component,
 File #E156876

GENERAL DESCRIPTION

The Model T16 Controller accepts signals from a variety of temperature sensors (thermocouple or RTD), while the Model P16 Controller accepts either a 0 to 10 VDC or 0/4 to 20 mA DC input signal. Both controllers can provide an accurate output control signal (time proportional or DC Analog Output) to maintain a process at a setpoint value. Dual 4-digit displays allow viewing of the process/temperature and setpoint simultaneously. Front panel indicators inform the operator of the controller and output status. The comprehensive programming allows these controllers to meet a wide variety of application requirements.

MAIN CONTROL

The controller operates in the PID Control Mode for both heating and cooling, with on-demand auto-tune, that establishes the tuning constants. The PID tuning constants may be fine-tuned through the front panel and then locked out from further modification. The controller employs a unique overshoot suppression feature, that allows the quickest response without excessive overshoot. Switching to Manual Mode provides the operator direct control of the output. The controller may also be programmed to operate in On/Off mode with adjustable hysteresis.

ALARMS

Optional alarm(s) can be configured independently for absolute high or low acting with balanced or unbalanced hysteresis. They can also be configured for deviation and band alarm. In these modes, the alarm trigger values track the setpoint value. Adjustable alarm hysteresis can be used for delaying output response. The alarms can be programmed for Automatic or Latching operation. A selectable standby feature suppresses the alarm during power-up until the temperature stabilizes outside the alarm region.

ANALOG OUTPUT OPTION

The optional DC Analog Output (10 V or 20 mA) can be configured and scaled for control or re-transmission purposes. The programmable output update time reduces valve or actuator activity.

PC PROGRAMMING KIT

The optional TP16KIT contains a programming module with a 9 pin RS232 connector, cable and Crimson, a Windows® based configuration software. The software allows downloading, uploading and storage of T16 and P16 program files. All controllers have a communications port that allows configuration by PC even without controller power connected. Controller calibration is also possible using the software when the proper calibration equipment and controller power is connected.

CONSTRUCTION

The controller is constructed of a lightweight, high impact, black plastic textured case and bezel with a clear display window. The front panel meets NEMA 4X/IP65 specifications when properly installed. In applications that do not require protection to NEMA 4X, multiple controllers can be stacked horizontally or vertically. Modern surface-mount technology, extensive testing, plus high immunity to noise interference makes the controller extremely reliable in industrial environments.

SAFETY SUMMARY

All safety related regulations, local codes and instructions that appear in the manual or on equipment must be observed to ensure personal safety and to prevent damage to either the instrument or equipment connected to it. If equipment is used in a manner not specified by the manufacturer, the protection provided by the equipment may be impaired.

Do not use the controller to directly command motors, valves, or other actuators not equipped with safeguards. To do so can be potentially harmful to persons or equipment in the event of a fault to the controller. An independent and redundant temperature limit indicator with alarm outputs is strongly recommended.

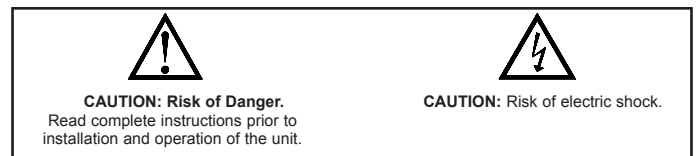

DIMENSIONS In inches (mm)

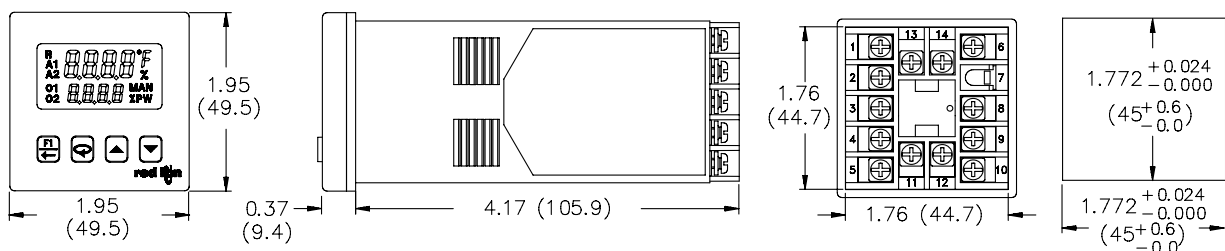

GENERAL SPECIFICATIONS

- DISPLAY:** 2 Line by 4-digit, LCD negative image transmissive with backlighting.
Top (Process) Display: 0.3" (7.6 mm) high digits with red backlighting.
Bottom (Parameter) Display: 0.2" (5.1 mm) high digits with green backlighting.
- ANNUNCIATORS:**
Status Annunciators:
 O1 - Main control output is active.
 O2 - Cooling output is active (when Alarm 2 is used for cooling).
 A1 - Alarm 1 output is active.
 A2 - Alarm 2 output is active.
 °F, °C - Temperature units.
 %PW - Output power percentage is shown in Bottom display.
 MAN - Controller is in Manual Mode.
 R - Ramping Setpoint indicator.
 % - Percent indicator (P16 models only).
Display Messages:
ULUL - Measurement exceeds + sensor range
ULUL - Measurement exceeds - sensor range
OPEN - Open sensor is detected (T16 only)
Short - Shorted sensor is detected (RTD only)
SEHS - Measurement exceeds controller limits (P16 only)
dddd - Display value exceeds + display range
-ddd - Display value exceeds - display range
- POWER:**
Line Voltage Models:
 85 to 250 VAC, 50/60 Hz, 8 VA
Low Voltage Models:
 DC Power: 18 to 36 VDC, 4 W
 AC Power: 24 VAC, ±10%, 50/60 Hz, 7 VA
- CONTROLS:** Three rubber push buttons for modification and setup of controller parameters. One additional button (F1) for user programmable function. One external user input (models with alarms) for parameter lockout or other user programmable functions.
- MEMORY:** Nonvolatile E²PROM retains all programmable parameters.
- ISOLATION LEVEL:**
AC power with respect to all other I/O: 250 V working (2300 V for 1 min.)
Sensor input to analog output: 50 V working (500 V for 1 minute)
Relay contacts to all other I/O: 300 V working (2300 V for 1 minute)
DC power with respect to sensor input and analog output: 50 V working (500 V for 1 minute)
- CERTIFICATIONS AND COMPLIANCES:**
SAFETY
 UL Recognized Component, File #E156876, UL873, CSA 22.2 No. 24
 Recognized to US and Canadian requirements under the Component Recognition Program of Underwriters Laboratories, Inc.

Type 4X Enclosure rating (Face only), UL50
 IEC 61010-1, EN 61010-1: Safety requirements for electrical equipment for measurement, control, and laboratory use, Part I
 IP65 Enclosure rating (Face only), IEC 529

ELECTROMAGNETIC COMPATIBILITY

Immunity to EN 50082-2

Electrostatic discharge	EN 61000-4-2	Level 2; 4 kV contact Level 3; 8 kV air
Electromagnetic RF fields	EN 61000-4-3	Level 3; 10 V/m ¹ 80 MHz - 1 GHz
Fast transients (burst)	EN 61000-4-4	Level 4; 2 kV I/O Level 3; 2 kV power
RF conducted interference	EN 61000-4-6	Level 3; 10 V/rms ² 150 KHz - 80 MHz

Emissions to EN 50081-2

RF interference	EN 55011	Enclosure class A Power mains class A
-----------------	----------	--

Notes:

- Self-recoverable loss of performance during EMI disturbance at 10 V/m: Measurement input signal may deviate during EMI disturbance. For operation without loss of performance: Install one ferrite core one turn, RLC #FCOR0000 or equivalent, to I/O cables at unit.*
- Self-recoverable loss of performance during EMI disturbance at 10 Vrms: Process and analog output signal may deviate during EMI disturbance. For operation without loss of performance: Install one ferrite core one turn, RLC #FCOR0000 or equivalent, to I/O cables and power cable at unit.*

Refer to the EMC Installation Guidelines section of this bulletin for additional information.

8. ENVIRONMENTAL CONDITIONS:

Operating Temperature Range: 0 to 50°C

Storage Temperature Range: -40 to 80°C

Operating and Storage Humidity: 85% max relative humidity (non-condensing) from 0°C to 50°C

Vibration According to IEC 68-2-6: 5 to 150 Hz, in X, Y, Z direction for 1.5 hours, 2 g's.

Shock According to IEC 68-2-27: Operational 20 g (10 g relay), 11 msec in 3 directions.

Altitude: Up to 2000 meters

9. CONNECTION:

Wire-clamping screw terminals

10. CONSTRUCTION:

Black plastic alloy case and collar style panel latch.

Panel latch can be installed for vertical or horizontal instrument stacking.

Black plastic textured bezel with transparent display window. Controller meets NEMA 4X/IP65 requirements for indoor use when properly installed.

Installation Category II, Pollution Degree 2.

11. WEIGHT:

6.3 oz (179 g)

INPUT SPECIFICATIONS

1. SENSOR INPUT:

Sample Period: 100 msec (10 Hz rate)

Step Response Time: 300 msec typical, 400 msec max to within 99% of final value with step input.

Failed Sensor Response:

Main Control Output(s): Programmable preset output

Display: "OPEN"

Alarms: Upscale drive

Analog Output: Upscale drive when assigned to retransmitted input.

Normal Mode Rejection: >40 dB @ 50/60 Hz

Common Mode Rejection: >120 dB, DC to 60 Hz

Overvoltage Protection: 120 VAC @ 15 sec max

2. RTD INPUTS: (T16 only)

Type: 2 or 3 wire

Excitation: 150 µA typical

Lead Resistance: 15 Ω max per input lead

Resolution: 1° or 0.1° for all types

TYPE	INPUT TYPE	RANGE	STANDARD
385	100 Ω platinum, Alpha = .00385	-200 to +600°C -328 to +1112°F	IEC 751
392	100 Ω platinum, Alpha = .003919	-200 to +600°C -328 to +1112°F	No official standard
672	120 Ω nickel, Alpha = .00672	-80 to +215°C -112 to +419°F	No official standard
Ohms	Linear Resistance	0.0 to 320.0 Ω	N/A

3. THERMOCOUPLE INPUTS: (T16 only)

Types: T, E, J, K, R, S, B, N, C, and Linear mV

Input Impedance: 20 MΩ for all types

Lead Resistance Effect: 0.25 µV/Ω

Cold Junction Compensation: Less than ±1°C typical (1.5°C max) error over ambient temperature range.

Resolution: 1° for types R, S, B and 1° or 0.1° for all other types

TYPE	DISPLAY RANGE	WIRE COLOR		STANDARD
		ANSI	BS 1843	
T	-200 to +400°C -328 to +752°F	(+) Blue (-) Red	(+) White (-) Blue	ITS-90
E	-200 to +750°C -328 to +1382°F	(+) Violet (-) Red	(+) Brown (-) Blue	ITS-90
J	-200 to +760°C -328 to +1400°F	(+) White (-) Red	(+) Yellow (-) Blue	ITS-90
K	-200 to +1250°C -328 to +2282°F	(+) Yellow (-) Red	(+) Brown (-) Blue	ITS-90
R	0 to +1768°C +32 to +3214°F	No standard	(+) White (-) Blue	ITS-90
S	0 to +1768°C +32 to +3214°F	No standard	(+) White (-) Blue	ITS-90
B	+149 to +1820°C +300 to +3308°F	No standard	No standard	ITS-90
N	-200 to +1300°C -328 to +2372°F	(+) Orange (-) Red	(+) Orange (-) Blue	ITS-90
C	0 to +2315°C +32 to +4199°F	No standard	No standard	ASTM E988-96
W5/W6				
mV	-5.00 mV to 56.00 mV	N/A	N/A	N/A

INPUT SPECIFICATIONS (Cont'd)

4. SIGNAL INPUT: (P16 only)

INPUT RANGE	ACCURACY *	IMPEDANCE	MAX CONTINUOUS OVERLOAD	RESOLUTION
10 VDC (-1 to 11)	0.30 % of reading +0.03V	1 MΩ	50 V	10 mV
20 mA DC (-2 to 22)	0.30 % of reading +0.04mA	10 Ω	100 mA	10 μA

* Accuracies are expressed as ± percentages over 0 to 50 °C ambient range after 20 minute warm-up.

OUTPUT SPECIFICATIONS

1. CONTROL AND ALARM OUTPUTS:

Relay Output:

Type: Form A

Contact Rating: 3 A @ 250 VAC or 30 VDC; 1/10 HP @ 120 VAC (inductive load)

Life Expectancy: 100,000 cycles at max. load rating

(Decreasing load and/or increasing cycle time, increases life expectancy)

Logic/SSR Output (main control output only):

Rating: 45 mA max @ 4 V min., 7 V nominal

2. MAIN CONTROL:

Control: PID or On/Off

Output: Time proportioning or DC Analog

Cycle Time: Programmable

Auto-Tune: When selected, sets proportional band, integral time, derivative time, and output dampening time. Also sets input filter and (if applicable) cooling gain.

Probe Break Action: Programmable

3. ALARMS: (optional) 2 relay alarm outputs.

Modes:

None

Absolute High Acting (Balanced or Unbalanced Hysteresis)

Absolute Low Acting (Balanced or Unbalanced Hysteresis)

Deviation High Acting

Deviation Low Acting

Inside Band Acting

Outside Band Acting

Heat (Alarm 1 on Analog Output models only)

Cool (Alarm 2)

5. TEMPERATURE INDICATION ACCURACY: (T16 only)

± (0.3% of span, +1°C) at 23 °C ambient after 20 minute warm up. Includes NIST conformity, cold junction effect, A/D conversion errors and linearization conformity.

Span Drift (maximum): 130 PPM/°C

6. USER INPUT: (Only controllers with alarms have a user input terminal.)

Internally pulled up to +7 VDC (100 KΩ), $V_{IN\ MAX} = 35\ V$, $V_{IL} = 0.6\ V$ max, $V_{IH} = 1.5\ V$ min, $I_{OFF} = 40\ \mu A$ max

Response Time: 120 msec max

Functions: Programmable

Reset Action: Programmable; automatic or latched

Standby Mode: Programmable; enable or disable

Hysteresis: Programmable

Sensor Fail Response: Upscale

Annunciator: "A1" and "A2" programmable for normal or reverse acting

4. COOLING: Software selectable (overrides Alarm 2).

Control: PID or On/Off

Output: Time proportioning

Cycle Time: Programmable

Proportional Gain Adjust: Programmable

Heat/Cool Deadband Overlap: Programmable

5. ANALOG DC OUTPUT: (optional)

Action: Control or retransmission

Update Rate: 0.1 to 250 sec

OUTPUT RANGE **	ACCURACY *	COMPLIANCE	RESOLUTION
0 to 10 V	0.3% of FS + ½ LSD	10 kΩ min	1/8000
0 to 20 mA	0.3% of FS + ½ LSD	500 Ω max	1/8000
4 to 20 mA	0.3% of FS + ½ LSD	500 Ω max	1/6400

* Accuracies are expressed as ± percentages over 0 to 50 °C ambient range after 20 minute warm-up.

** Outputs are independently jumper selectable for either 10 V or 20 mA. The output range may be field calibrated to yield approximately 5% overrange and a small underrange (negative) signal.

ORDERING INFORMATION

MODEL NO.	MAIN CONTROL	2 ALARMS & USER INPUT	PART NUMBERS	
			18-36 VDC/24 VAC	85 to 250 VAC
T16	Relay	—	T1610010	T1610000
	Relay	Yes	T1611110	T1611100
	Logic/SSR	—	T1620010	T1620000
	Logic/SSR	Yes	T1621110	T1621100
	Analog Out *	Yes	T1641110	T1641100
P16	Relay	—	P1610010	P1610000
	Relay	Yes	P1611110	P1611100
	Logic/SSR	—	P1620010	P1620000
	Logic/SSR	Yes	P1621110	P1621100
	Analog Out *	Yes	P1641110	P1641100

* Analog out may be used for retransmitted signals. When using analog output for retransmitted signals, AL1 becomes main control O1, if selected for heating in the analog out models.

ACCESSORIES

MODEL NO.	DESCRIPTION	PART NUMBERS
TP16	Programming Kit 1 : Includes Software, Comms Module w/ 9-pin connector and cable, and 115 VAC Power Adapter	TP16KIT1
	Programming Kit 2 : Includes Software, Comms Module w/ 9-pin connector and cable	TP16KIT2
RLY	External SSR Power Unit (for Logic/SSR models)	RLY50000
	25 A Single Phase Din Rail Mount Solid State Relay	RLY60000
	40 A Single Phase Din Rail Mount Solid State Relay	RLY6A000
	Three Phase Din Rail Mount Solid State Relay	RLY70000

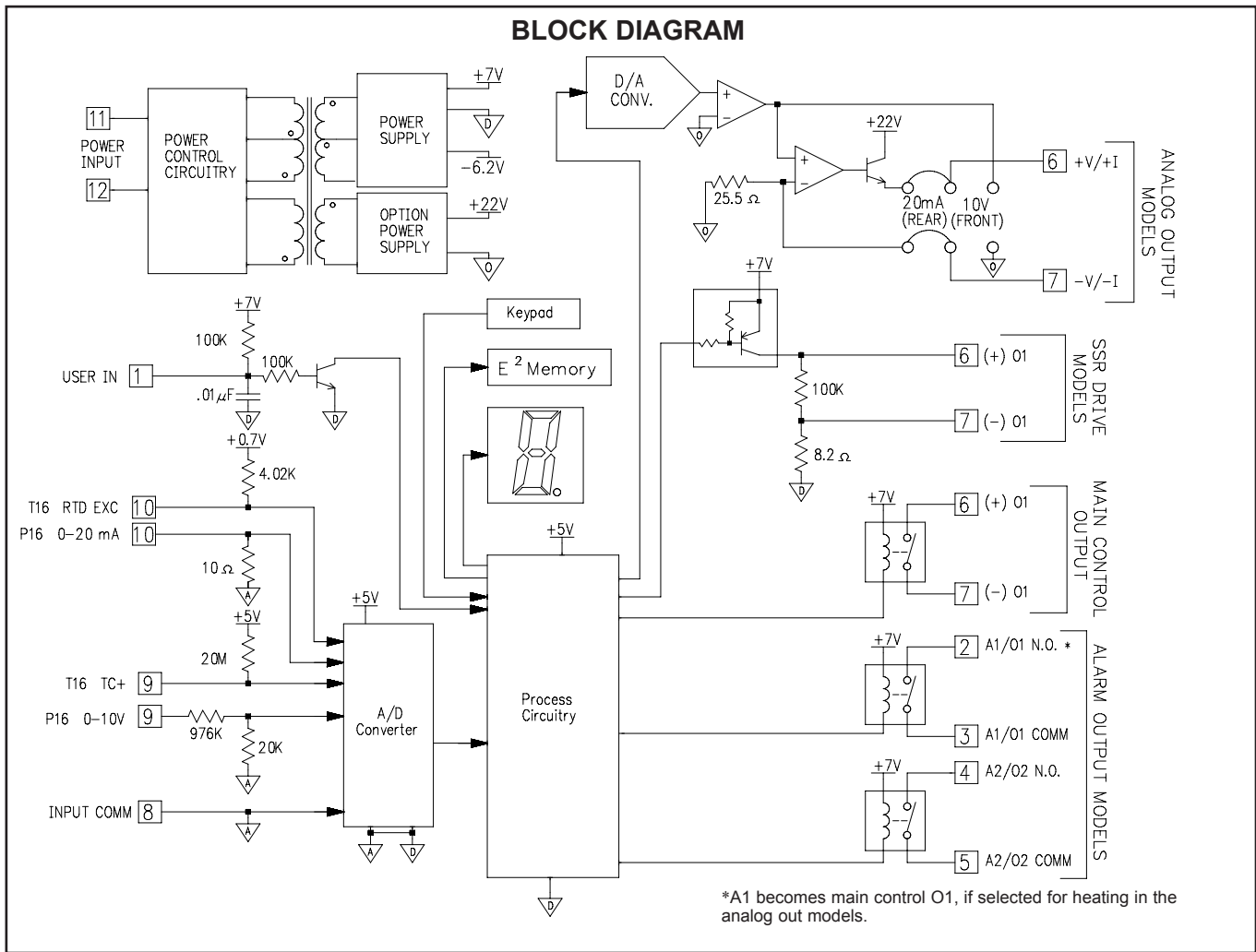

EMC INSTALLATION GUIDELINES

Although this controller is designed with a high degree of immunity to Electromagnetic Interference (EMI), proper installation and wiring methods must be followed to ensure electromagnetic compatibility (EMC) in each application. The type of the electrical noise, source or coupling method into the controller may be different for various installations. The controller becomes more immune to EMI with fewer I/O connections. Cable length, routing, and shield termination are very important and can mean the difference between a successful or troublesome installation. Listed are some EMC guidelines for successful installation in an industrial environment.

1. The controller should be mounted in a metal enclosure that is properly connected to protective earth.
2. Use shielded (screened) cables for all Signal and Control inputs. The shield (screen) pigtail connection should be made as short as possible. The connection point for the shield depends somewhat upon the application. Listed below are the recommended methods of connecting the shield, in order of their effectiveness.
 - a. Connect the shield only at the panel where the controller is mounted to earth ground (protective earth).
 - b. Connect the shield to earth ground at both ends of the cable, usually when the noise source frequency is more than 1 MHz.
 - c. Connect the shield to common of the controller and leave the other end of the shield unconnected and insulated from earth ground.
3. Never run Signal or Control cables in the same conduit or raceway with AC power lines, conductors feeding motors, solenoids, SCR controls, and heaters, etc. The cables should be run through metal conduit that is properly grounded. This is especially useful in applications where cable runs are long and portable two-way radios are used in close proximity or if the installation is near a commercial radio transmitter.

4. Signal or Control cables within an enclosure should be routed as far away as possible from contactors, control relays, transformers, and other noisy components.

5. In extremely high EMI environments, the use of external EMI suppression devices, such as ferrite suppression cores, is effective. Install them on Signal and Control cables as close to the controller as possible. Loop the cable through the core several times or use multiple cores on each cable for additional protection. Install line filters on the power input cable to the controller to suppress power line interference. Install them near the power entry point of the enclosure. The following EMI suppression devices (or equivalent) are recommended:

Ferrite Suppression Cores for Signal and Control cables:

Fair-Rite # 0443167251 (Red Lion Controls # FCOR0000)

TDK # ZCAT3035-1330A

Steward # 28B2029-0A0

Line Filters for input power cables:

Schaffner # FN610-1/07 (Red Lion Controls # LFIL0000)

Schaffner # FN670-1.8/07

Corcom # 1 VR3

Note: Reference manufacturer's instructions when installing a line filter.

6. Long cable runs are more susceptible to EMI pickup than short cable runs. Therefore, keep cable runs as short as possible.

7. Switching of inductive loads produces high EMI. Use of snubbers across inductive loads suppresses EMI.

Snubber: Red Lion Controls # SNUB0000.

1.0 SETTING THE JUMPERS (ANALOG OUTPUT MODELS ONLY)

To insure proper operation, the Analog Output jumpers must be set to the same range selected in programming Module 2-OP. **The default jumper setting is for 20 mA. The default setting in Module 2-OP is 4-20 mA.** To access the jumpers, insert a flat-blade screwdriver between the front panel and the side case slot. This should disengage the top and bottom front panel latches from the case grooves. Pull the front panel assembly with the controller boards out of the case. The jumpers are located inside the controller on the left board along the back top section.

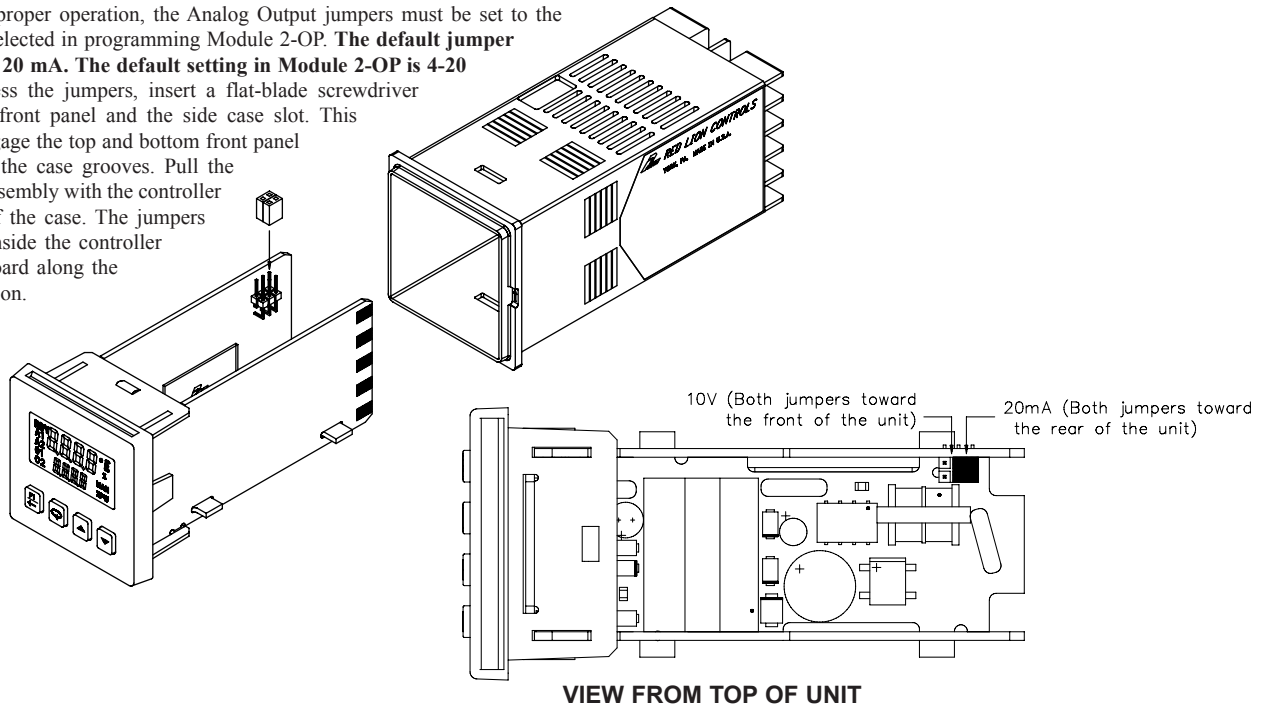

2.0 INSTALLING THE CONTROLLER

The T16 and P16 controllers meet NEMA 4X/IP65 requirements for indoor use to provide a watertight seal in steel panels with a minimum thickness of 0.09", or aluminum panels with a minimum thickness of 0.12". The controllers are designed to be mounted into an enclosed panel. The bezel assembly must be in place during installation of the controller.

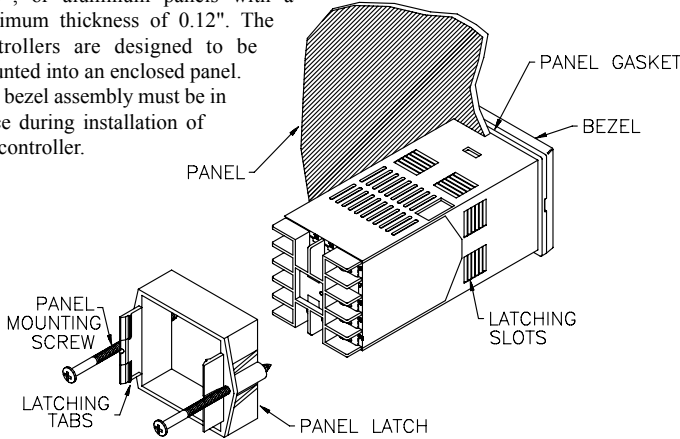

Instructions:

1. Prepare the panel cutout to the proper dimensions.
2. Remove the panel latch from the controller. Discard the cardboard sleeve.
3. Carefully remove the center section of the panel gasket and discard. Slide the panel gasket over the rear of the controller, seating it against the lip at the front of the case.
4. Insert the controller into the panel cutout. While holding the controller in place, push the panel latch over the rear of the controller, engaging the tabs of the panel latch in the farthest forward slot possible.
5. To achieve a proper seal, tighten the panel latch screws evenly until the controller is snug in the panel, torquing the screws to approximately 7 in-lb (79 N-cm). Overtightening can result in distortion of the controller, and reduce the effectiveness of the seal.

Note: The installation location of the controller is important. Be sure to keep it away from heat sources (ovens, furnaces, etc.) and away from direct contact with caustic vapors, oils, steam, or any other process by-products in which exposure may affect proper operation.

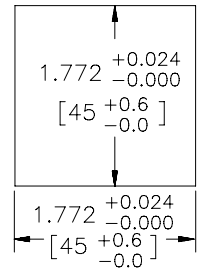

Multiple Controller Stacking

The controller is designed to allow for close spacing of multiple controllers in applications that do not require protection to NEMA 4X. Controllers can be stacked either horizontally or vertically. For vertical stacking, install the panel latch with the screws to the sides of the controller. For horizontal stacking, the panel latch screws should be at the top and bottom of the controller. The minimum spacing from centerline to centerline of controllers is 1.96" (49.8 mm). This spacing is the same for vertical or horizontal stacking.

Note: When stacking controllers, provide adequate panel ventilation to ensure that the maximum operating temperature range is not exceeded.

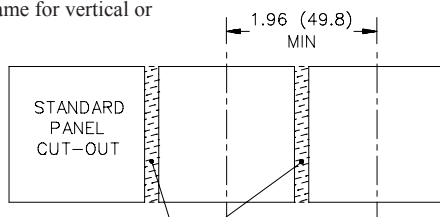

IF NEMA 4 IS NOT REQUIRED, THIS PANEL MATERIAL MAY BE REMOVED.

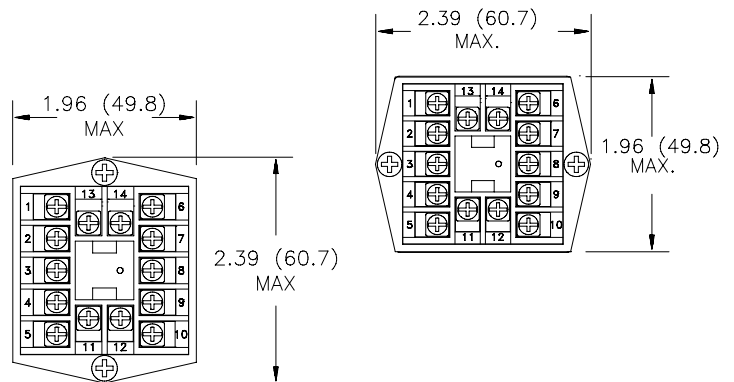

3.0 WIRING THE CONTROLLER

WIRING CONNECTIONS

All wiring connections are made to the rear screw terminals. When wiring the controller, use the numbers on the label and those embossed on the back of the case, to identify the position number with the proper function.

All conductors should meet voltage and current ratings for each terminal. Also, cabling should conform to appropriate standards of good installation, local

codes and regulations. It is recommended that power (AC or DC) supplied to the controller be protected by a fuse or circuit breaker. Strip the wire, leaving approximately 1/4" (6 mm) bare wire exposed (stranded wires should be tinned with solder). Insert the wire under the clamping washer and tighten the screw until the wire is clamped tightly.

CONTROLLER POWER CONNECTIONS

For best results, the power should be relatively "clean" and within the specified limits. Drawing power from heavily loaded circuits or from circuits that also power loads that cycle on and off should be avoided. It is recommended that power supplied to the controller be protected by a fuse or circuit breaker.

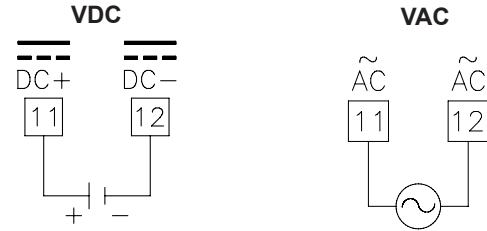

INPUT CONNECTIONS

For two wire RTDs, install a copper sense lead of the same gauge and length as the RTD leads. Attach one end of the wire at the probe and the other end to input common terminal. Complete lead wire compensation is obtained. This is

the preferred method. If a sense wire is not used, then use a jumper. A temperature offset error will exist. The error may be compensated by programming a temperature offset.

RTD and Resistance

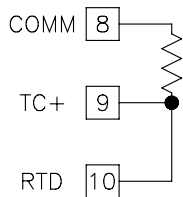

Thermocouple and Millivolt

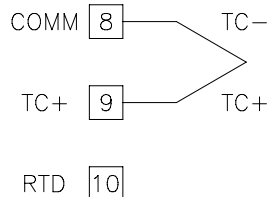

Voltage and Current

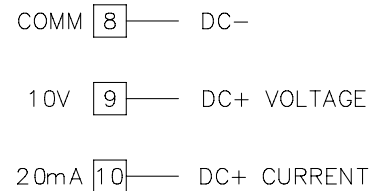

CONTROL AND ALARM OUTPUT CONNECTIONS

Alarm Models

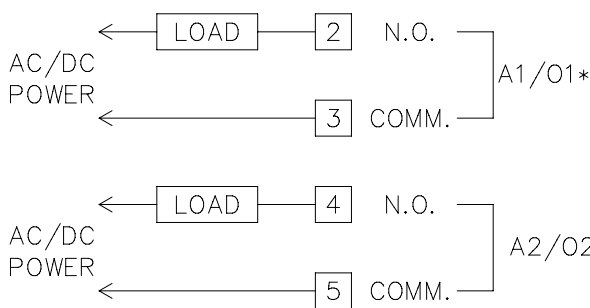

*A1 becomes main control O1, if selected for heating in the analog out models.

Main Control Relay Models

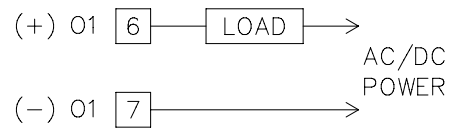

Main Control Logic/SSR Models

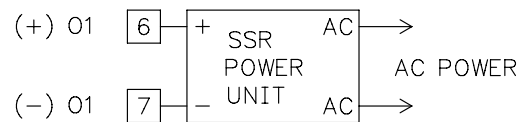

ANALOG DC OUTPUT CONNECTIONS

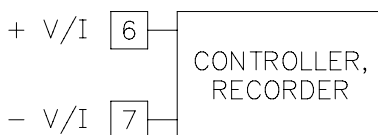

USER INPUT CONNECTIONS

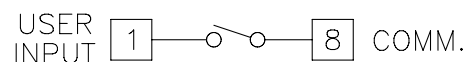

4.0 REVIEWING THE FRONT KEYS AND DISPLAY

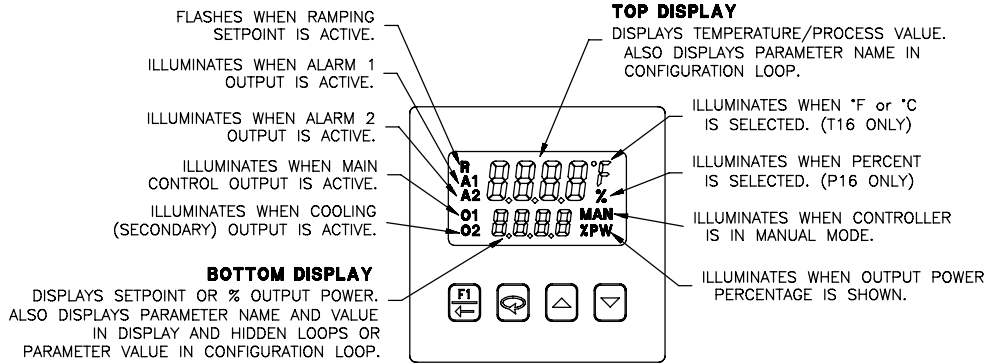

FRONT PANEL KEYS

The F1 key is pressed to exit (or escape) directly to the start of the Display Loop. While in the Display Loop, the F1 key can be pressed to activate its programmed function.

The Arrow keys are used to scroll through parameter selections/values and in the Configuration Loop they are used to scroll to the appropriate Parameter Module.

The Loop key is pressed to advance to the next parameter, to activate a changed selection/value, and when held for three seconds, enter the Hidden Loop.

5.0 PROGRAMMING: DISPLAY LOOP

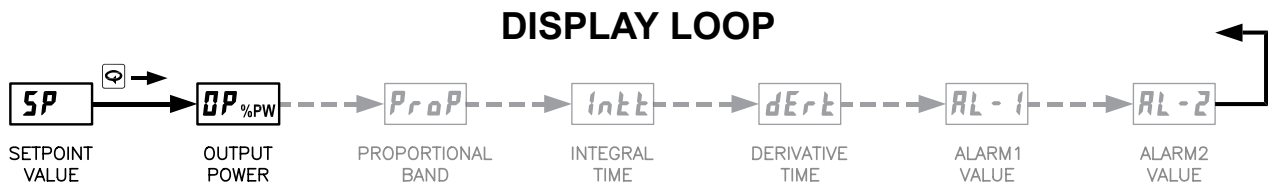

Note: Setpoint and Output Power are the only parameters visible in the Display Loop with Factory Settings. The remaining parameters can be selected for the Display Loop within Module 3. Parameter availability is model and programming dependent.

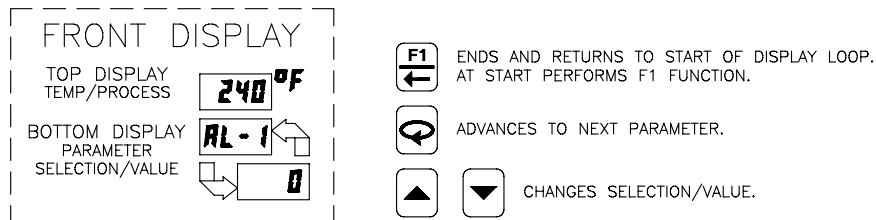

DISPLAY LOOP

At power up, all display segments light, and then the programmed input type and the controller's software version will flash. Then the Temperature/Process Value is shown in the top display, and the Setpoint Value is shown in the bottom display. This is the Display Loop. If the Setpoint is hidden or locked, the Display Loop will default to Output Power. If Output Power is also hidden or locked out, the bottom display is blank. During programming, the F1 key can be pressed to return the controller to this point. (Only in the Display Loop will the F1 key perform the user F1 function programmed in Input Module 1-11.)

When the is pressed the controller advances to the next parameter in the Display Loop. Except for Setpoint and % Output Power, the bottom display alternates between the parameter name and its selection/value. The arrow keys are pressed to change the selection/value for the shown parameter. The new selection/value is activated when the is pressed. Display Loop parameters may be locked out or hidden in Lockout Module 3-11. Some parameters are model and programming dependent.

The values shown for the displays are the factory settings.

SETPOINT VALUE (SP1) *

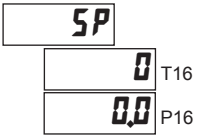

- 9999 to 9999

SETPOINT VALUE (SP2) *

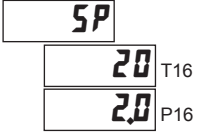

- 9999 to 9999

Typically, the controller is operating with the Setpoint value in the bottom display. There is no annunciator nor parameter indication for Setpoint in the Display Loop. The parameter name alternates with the setpoint value in the Hidden Loop. The Setpoint value can be changed, activated and stored by pressing the arrow keys. This is the only parameter that can be configured as read only in the Display Loop, but read/write in the Hidden Loop. It is possible to store a second Setpoint value that can be selected in the Hidden Loop, by the F1 key or the user input. Both Setpoint values are limited by the Setpoint Low and High Limits in Input Module 1-17.

% OUTPUT POWER *



- 100 to 1000

The % Output Power is shown with the %PW annunciator. The parameter name alternates with the % Output Power value in the Hidden Loop. While the controller is in Automatic Mode, this value is read only. When the controller is placed in Manual Mode, the value can be changed, activated and stored by pressing the arrow keys. For more details on % Output Power, see Control Mode Explanations.

OUTPUT POWER OFFSET



- 100 to 1000

When the Integral Time is set to zero and the controller is in the Automatic Mode, this parameter will appear after % Output Power. It is also shown with the %PW annunciator illuminated. The power offset is used to shift the proportional band to compensate for errors in the steady state. If Integral Action is later invoked, the controller will re-calculate the internal integral value to provide "bumpless" transfer and Output Power Offset will not be necessary.

PROPORTIONAL BAND



0.0 to 999.9
(% of full input range)

The proportional band should be set to obtain the best response to a process disturbance while minimizing overshoot. A proportional band of 0.0% forces the controller into On/Off Control with its characteristic cycling at Setpoint. For more information, see Control Mode and PID Tuning Explanations.

INTEGRAL TIME

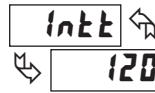

0 to 9999 seconds

Integral action shifts the center point position of the proportional band to eliminate error in the steady state. The higher the integral time, the slower the response. The optimal integral time is best determined during PID Tuning. If time is set to zero, the previous Integral output power value is maintained. Offset Power can be used to provide Manual Reset.

DERIVATIVE TIME

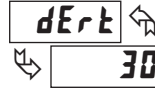

0 to 9999 seconds per repeat

Derivative time helps to stabilize the response, but too high of a derivative time, coupled with noisy signal processes, may cause the output to fluctuate too greatly, yielding poor control. Setting the time to zero disables derivative action.

ALARM 1 VALUE

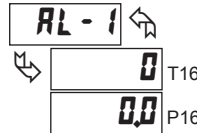

- 999 to 9999

On models with alarms, the value for Alarm 1 can be entered here. The value is either absolute (absolute alarm types) or relative to the Setpoint value (deviation and band alarm types.) When Alarm 1 is programmed for *HEAL* or *HALF*, this parameter is not available. For more details on alarms, see Alarm Module 4-RL.

ALARM 2 VALUE

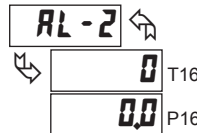

- 999 to 9999

On models with alarms, the value for Alarm 2 can be entered here. The value is either absolute (absolute alarm types) or relative to the Setpoint value (deviation and band alarm types.) When Alarm 2 is programmed for *LOAL* or *HIGH*, this parameter is not available. For more details on alarms, see the Alarm Module 4-RL.

* Alternating indication only used in the Hidden Loop.

6.0 PROGRAMMING: HIDDEN LOOP



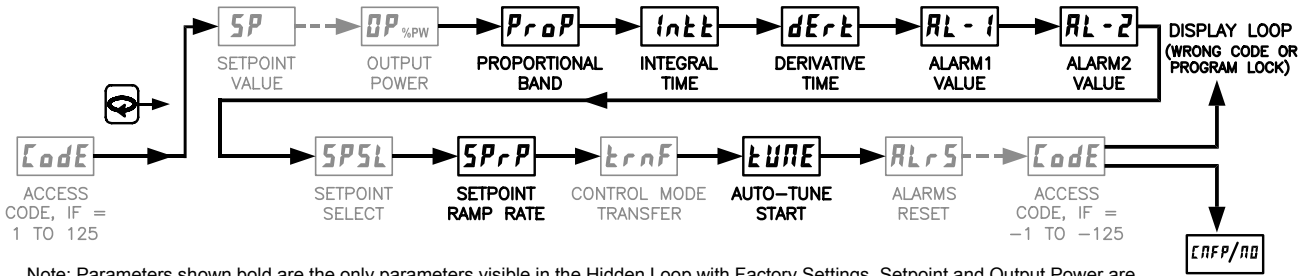

To enter Hidden Loop, press  for 3 seconds.

HIDDEN LOOP

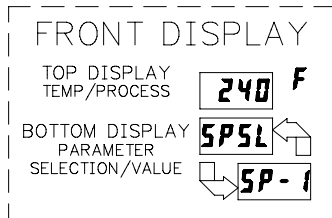





Note: Parameters shown bold are the only parameters visible in the Hidden Loop with Factory Settings. Setpoint and Output Power are factory set for the Display Loop. The remaining parameters can be selected for the Hidden Loop within Module 3. Parameter availability is model and programming dependent.



-  ENDS AND RETURNS TO START OF DISPLAY LOOP.
-  ADVANCES TO NEXT PARAMETER.
-   CHANGES SELECTION/VALUE.

HIDDEN LOOP

When  is pressed and held for three seconds, the controller advances to the Hidden Loop. The Temperature/Process Value is shown in the top display. The bottom display alternates between the parameter and its selection/value.  or  is pressed to change the selection/value for the shown parameter. The new selection/value is activated after  is pressed. When  is pressed, the controller returns to the Display Loop and stores changed selection/values to permanent memory. Hidden Loop parameters may be locked out in Lockout Module 3-11. Some parameters are model and programming dependent.

ACCESS CODE



If the Access Code is set from 1 to 125, in Lockout Module 3-11, Access Code will appear here. By entering the proper Code, access to the Hidden Loop is permitted. With the factory setting of 0, Access Code will not appear in the Hidden Loop. A universal code of 111 can be entered to gain access, independent of the programmed code number.

SETPOINT SELECT



The SPSL function allows the operator to switch from or to, setpoint 1 and setpoint 2. In the Display Loop, there is no annunciator indicating the selected Setpoint, however, the selected Setpoint value is displayed and activated.

SETPOINT RAMP RATE



The setpoint ramp rate can reduce sudden shock to the process and reduce overshoot on startup or after setpoint changes, by ramping the setpoint at a controlled rate. R annunciator flashes while ramping. With the T16, the ramp rate is always in tenths of degrees per minute, regardless of the resolution chosen for the process display. With the P16, the ramp rate is in least-significant (display units) digits per minute. A value of 0.0 or 0 disables setpoint ramping. Once the ramping setpoint reaches the target setpoint, the setpoint ramp rate disengages until the setpoint is changed again. If the ramp value is changed during ramping, the new ramp rate takes effect. If the setpoint is ramping prior to starting Auto-Tune, the ramping is suspended during Auto-Tune and then resumed afterward. Deviation and band alarms are relative to the target setpoint, not the ramping setpoint. A slow process may not track the programmed setpoint rate. At power up, the ramping setpoint is initialized at the ambient temperature/process value.

CONTROL MODE TRANSFER



In Automatic Mode, the percentage of Output Power is automatically determined by the controller. In Manual/User *USER* Mode, the percentage of Output Power is adjusted manually while in the Display Loop. The Control Mode can also be transferred through the F1 Key or User Input. For more information, see Control Mode Explanations.

AUTO-TUNE START



The Auto-Tune procedure of the controller sets the Proportional Band, Integral Time, Derivative Time, Digital Filter, Control Output Dampening Time, and Relative Gain (Heat/Cool) values appropriate to the characteristics of the process. This parameter allows front panel starting **YES** or stopping **NO** of Auto-Tune. For more information, see PID Tuning Explanations.

ACCESS CODE



If the Access Code is set from -1 to -125, in Lockout Module **3-LL**, Access Code will appear here. By entering the proper Code, access to the Configuration Loop is permitted (with a negative Code value, the Hidden Loop can be accessed without the use of a code). With the factory setting of 0 or with an active User Input configured for Program Lock (**PLBL**), Access Code will not appear here. An active user input configured for Program Lock (**PLBL**) always locks out the Configuration Loop, regardless of Access Code.

ALARMS RESET



With alarm models, the alarms can be manually reset. The up key resets Alarm 1 and the down key resets Alarm 2.

7.0 PROGRAMMING: CONFIGURATION LOOP

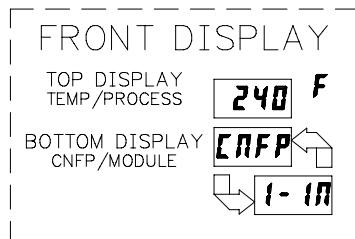
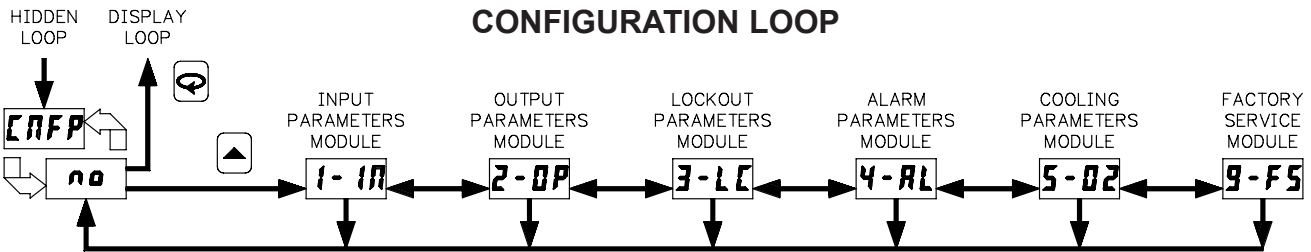

- ENDS AND RETURNS TO START OF DISPLAY LOOP.
- ENTERS MODULE OR AT **CNFP/NO** RETURNS TO DISPLAY LOOP.
- ADVANCES TO NEXT MODULE.

To access the Configuration Loop, press the up key when **CNFP/NO** is displayed in the Hidden Loop. The arrow keys are used to select the parameter module (1-9). To enter a specific module press while the module number is displayed. In the Configuration Loop, **CNFP** will alternate with the parameter number in the bottom display. The Temperature/Process Value is shown in the top display.

After entering a parameter module, press to advance through the parameter names in the module. To change a parameter's selection/value, press the arrow keys while the parameter is displayed. In the modules, the top display shows the parameter name, and the bottom display shows the selection/value. Use to enter any selection/values that have been changed. The change is not committed to permanent memory until the controller is returned to the Display Loop. If a power loss occurs before returning to the Display Loop, the new values must be entered again.

At the end of each module, the controller returns to **CNFP/NO**. At this location, pressing again returns the display to the the Display Loop. Pressing the Up key allows re-entrance to the Configuration Loop. Whenever is pressed, **End** momentarily appears as the parameters are stored to permanent memory and the controller returns to the Display Loop.

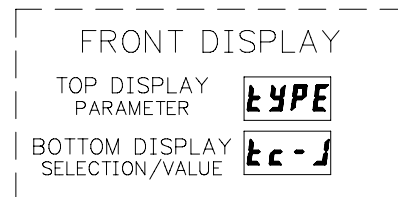

- ENDS AND RETURNS TO START OF DISPLAY LOOP.
- ADVANCES TO NEXT PARAMETER OR AT **CNFP/NO** RETURNS TO DISPLAY LOOP.
- ADVANCES SELECTION/VALUE.

7.1 MODULE 1 - INPUT PARAMETERS (1-17) T16 ONLY

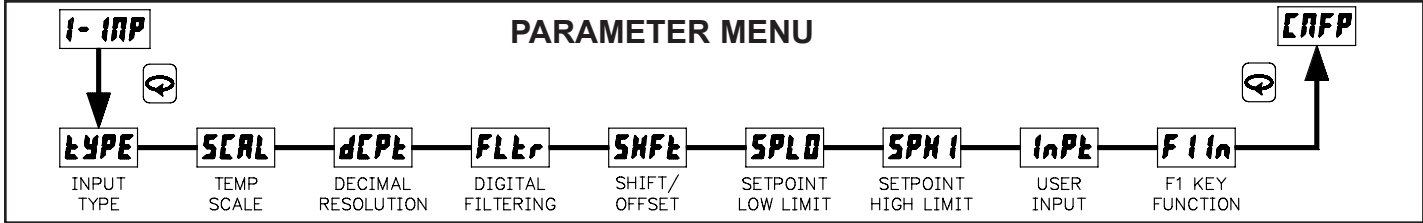

INPUT TYPE

SELECTION	TYPE	SELECTION	TYPE
tc-t	T TC	tc-n	N TC
tc-E	E TC	tc-C	C TC
tc-d	J TC	L 17	Linear mV
tc-K	K TC	r 385	RTD 385
tc-r	R TC	r 392	RTD 392
tc-S	S TC	r 672	RTD 672
tc-b	B TC	r L 17	Linear Ohms

Select the input type that corresponds to the input sensor.

TEMPERATURE SCALE

SCAL	°F Fahrenheit
°C	°C Celsius

Select either degrees Fahrenheit or Celsius. For linear mV and ohms input types, this has no effect. If changed, adjust related parameter values, as the controller does not automatically convert them.

DECIMAL RESOLUTION

dCPE	0 to 0.0 for temperature and resistance inputs
0.00	0.00 for mV inputs

Select whole degrees, or tenths of degrees for Temperature display, Setpoint values, and related parameters. For Linear Resistance inputs r L 17, the same parameter selections apply in ohms or tenths of an ohm. For mV inputs L 17, only hundredths of a mV resolution is available.

DIGITAL FILTERING

FLtR	0 = least to 4 = most
1	

The filter is an adaptive digital filter that discriminates between measurement noise and actual process changes. If the signal is varying too greatly due to measurement noise, increase the filter value. If the fastest controller response is needed, decrease the filter value.

SHIFT/OFFSET

SHFE	-999 to 9999 degrees
0	

This value offsets the controller's temperature display value by the entered amount. This is useful in applications in which the sensor cannot provide the actual temperature signal due to mounting constraints, inaccuracy, etc.

SETPOINT LOW LIMIT

SPLD	-999 to 9999
0	

The controller has a programmable low setpoint limit value to restrict the setting range of the setpoint. Set the limit so that the setpoint value cannot be set below the safe operating area of the process.

SETPOINT HIGH LIMIT

SPH1	-999 to 9999
9999	

The controller has a programmable high setpoint limit value to restrict the setting range of the setpoint. Set the limit so that the setpoint value cannot be set above the safe operating area of the process.

USER INPUT FUNCTION (OPTIONAL)

SELECTION	FUNCTION	SELECTION	FUNCTION
None	No Function	SPt	Setpoint 1 or 2 Select
PLDC	Program Lock	SPrP	Setpoint Ramp Disable
ILDC	Integral Action Lock	RLrS	Reset Both Alarms
trnF	Auto/Manual Select		

The controller performs the selected User Input function (User Input available only on models with alarms), when the User terminal 1 is connected (pulled low) to Common terminal 8.

No Function: No function is performed.

Program Lock: The Configuration Loop is locked, as long as activated (maintained action).

Integral Action Lock: The integral action of the PID computation is disabled (frozen), as long as activated (maintained action).

Auto/Manual Select: This function selects (maintained action) Automatic (open) or Manual Control (activated).

Setpoint 1 or 2 Select: This function selects (maintained action) Setpoint 1 (open) or Setpoint 2 (activated) as the active setpoint.

Setpoint Ramp Disable: The setpoint ramping feature is disabled, as long as activated (maintained action). Any time the user input is activated with a ramp in process, ramping is aborted.

Reset Alarms: Active alarms are reset, as long as activated (maintained action). Active alarms are reset until the alarm condition is cleared and triggered again (momentary action).

F1 KEY FUNCTION

F1 In
NOFE

SELECTION	FUNCTION	SELECTION	FUNCTION
NOFE	No Function	R1r5	Reset Alarm 1
AutoM	Auto/Manual Select	R2r5	Reset Alarm 2
SPt	Setpoint 1 or 2 Select	RLr5	Reset Both Alarms

The controller performs the selected F1 Key Function, when **F1** is pressed while in the Display Loop. In any other loop or module location, pressing **F1** will perform an escape to the Display Loop.

No Function: No function is performed.

Auto/Manual Select: This function toggles (momentary action) the controller between Automatic and Manual Control.

Setpoint 1 or 2 Select: This function toggles (momentary action) the controller between Setpoint 1 and Setpoint 2.

Reset Alarms: This function can be used to reset one or both of the alarms when activated (momentary action) The alarm will remain reset until the alarm condition is cleared and triggered again.

7.1 MODULE 1 - INPUT PARAMETERS (1- IN) P16 ONLY

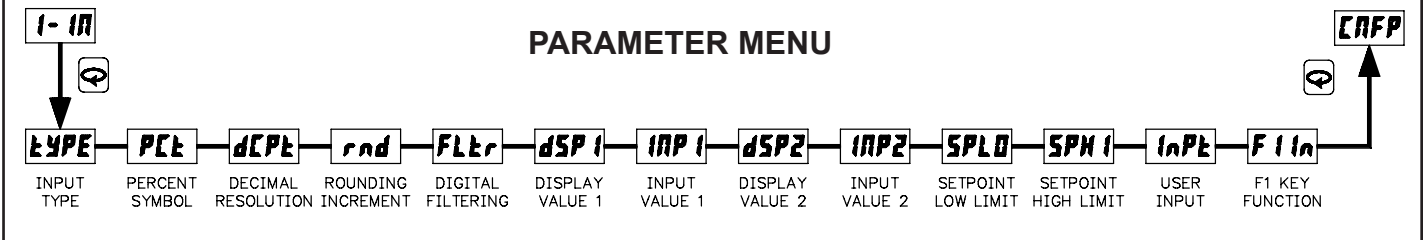

INPUT TYPE

TYPE
Curr

SELECTION	TYPE
Curr	Current
volt	Voltage

Select the input type that corresponds to the input signal.

PERCENT ANNUNCIATOR

Pct
NO

YES	On
NO	Off

This only illuminates the % annunciator. It does not perform any type of percent function, but is useful in applications that have been scaled in percent.

DECIMAL RESOLUTION

dCpt
0.0

0 0.0 0.00 0.000

This selection affects the decimal point placement for the Process value, and related parameters.

ROUNDING INCREMENT

rnd
0.1

1 to 100
In steps of 1 least significant digit, regardless of decimal point.

Rounding selections other than 1 cause the process value display to round to the nearest rounding increment selected. (For example, rounding of 5 causes 122 to round to 120 and 123 to round to 125.) Rounding starts at the least significant digit of the process value. Setpoint values, Setpoint limits, Alarm values, Input Scaling values, and Analog Scaling values are not affected by rounding.

DIGITAL FILTERING

FLtr
1

0 = least to 4 = most

The filter is an adaptive digital filter that discriminates between measurement noise and actual process changes. If the signal is varying too greatly due to measurement noise, increase the filter value. If the fastest controller response is needed, decrease the filter value.

SCALING

To scale the controller, two scaling points are necessary. Each scaling point has a coordinate pair of Display Values and Input Values. It is recommended that the two scaling points be at the low and high ends of the input signal being measured. Process value scaling will be linear between and continue past the entered points to the limits of the input range. (Factory settings example will display 0.0 at 4.00 mA input and display 100.0 at 20.00 mA input.) Reverse acting indication can be accomplished by reversing the two signal points or the Display value points, but not both. If both are reversed, forward (normal) acting indication will occur. In either case, do not reverse the input wires to change the action.

DISPLAY VALUE SCALING POINT 1

dSP1
0.0

-999 to 9999

Enter the first coordinate Display Value by using the arrow keys.

INPUT VALUE SCALING POINT 1

INP1
4.00

0.00 to 20.00 mA
0.00 to 10.00 V

For Key-in Method, enter the first coordinate Input Value by using the arrow keys. To allow the P16 to "learn" the signal, use the Applied Method. For Applied Method, press **F1**. The ° annunciator is turned on to indicate the applied method. Adjust the applied signal level externally until the appropriate value appears under **INP1**. Using either method, press **Enter** to store the value for **INP1**. (The controller can be toggled back to the Key-in Method by pressing **F1** before **Enter**.)

DISPLAY VALUE SCALING POINT 2

dSP2
100.0

-999 to 9999

Enter the second coordinate Display Value by using the arrow keys.

INPUT VALUE SCALING POINT 2

INP2	0.00 to 20.00 mA
20.00	0.00 to 10.00 V

For Key-in Method, enter the second coordinate Input Value by using the arrow keys. To allow the P16 to “learn” the signal, use the Applied Method. For Applied Method, press $\left[\frac{PI}{\square} \right]$. The ° annunciator is turned on to indicate the applied method. Adjust the applied signal level externally until the appropriate value appears under **INP2**. Using either method, press $\left[\leftarrow \right]$ to store the value for **INP2**. (The controller can be toggled back to the Key-in Method by pressing $\left[\frac{PI}{\square} \right]$ before $\left[\leftarrow \right]$.)

SETPOINT LOW LIMIT

SPLO	-999 to 9999
00	

The controller has a programmable low setpoint limit value to restrict the setting range of the setpoint. Set the limit so that the setpoint value cannot be set below the safe operating area of the process.

SETPOINT HIGH LIMIT

SPHI	-999 to 9999
9999	

The controller has a programmable high setpoint limit value to restrict the setting range of the setpoint. Set the limit so that the setpoint value cannot be set above the safe operating area of the process.

USER INPUT FUNCTION (OPTIONAL)

INPt
PLDC

SELECTION	FUNCTION	SELECTION	FUNCTION
NOFE	No Function	SPt	Setpoint 1 or 2 Select
PLDC	Program Lock	SPrP	Setpoint Ramp Disable
ILDC	Integral Action Lock	ALrS	Reset Both Alarms
trnF	Auto/Manual Select		

The controller performs the selected User Input function (User Input available only on models with alarms), when the User terminal 1 is connected (pulled low) to Common terminal 8.

No Function: No function is performed.

Program Lock: The Configuration Loop is locked, as long as activated (maintained action).

Integral Action Lock: The integral action of the PID computation is disabled (frozen), as long as activated (maintained action).

Auto/Manual Select: This function selects (maintained action) Automatic (open) or Manual Control (activated).

Setpoint 1 or 2 Select: This function selects (maintained action) Setpoint 1 (open) or Setpoint 2 (activated) as the active setpoint.

Setpoint Ramp Disable: The setpoint ramping feature is disabled, as long as activated (maintained action). Any time the user input is activated with a ramp in process, ramping is aborted.

Reset Alarms: Active alarms are reset, as long as activated (maintained action). Active alarms are reset until the alarm condition is cleared and triggered again (momentary action).

F1 KEY FUNCTION

F1In
NOFE

SELECTION	FUNCTION	SELECTION	FUNCTION
NOFE	No Function	ALrS	Reset Alarm 1
trnF	Auto/Manual Select	ALrS	Reset Alarm 2
SPt	Setpoint 1 or 2 Select	ALrS	Reset Both Alarms

The controller performs the selected F1 key function, when $\left[\frac{F1}{\square} \right]$ is pressed while in the Display Loop. In any other loop or module location, pressing $\left[\frac{F1}{\square} \right]$ will perform an escape to the Display Loop.

No Function: No function is performed.

Auto/Manual Select: This function toggles (momentary action) the controller between Automatic and Manual Control.

Setpoint 1 or 2 Selection: This function toggles (momentary action) the controller between Setpoint 1 and Setpoint 2.

Reset Alarms: This function can be used to reset one or both of the alarms when activated (momentary action). The alarm will remain reset until the alarm condition is cleared and triggered again.

7.2 MODULE 2 - OUTPUT PARAMETERS (2-OP)

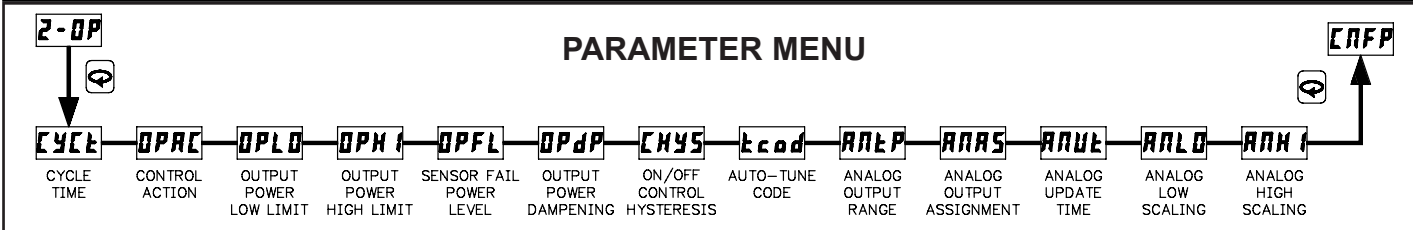

CYCLE TIME

CYCLE
2.0

0.0 to 250.0 seconds

The Cycle Time is entered in seconds with one tenth of a second resolution. It is the total time for one on and one off period of the time proportioning control output O1. With time proportional control, the percentage of power is converted into an output on-time relative to the cycle time value set. (If the controller calculates that 65% power is required and a cycle time of 10.0 seconds is set, the output will be on for 6.5 seconds and off for 3.5 seconds.) For best control, a cycle time equal to one-tenth or less, of the natural period of oscillation of the process is recommended. When using the Analog Output signal for control, the Cycle Time setting has no effect. If the O1 output is not being used, a cycle time of 0 can be entered to prevent the output and indicator from cycling.

CONTROL ACTION

OPAC
rEu

drct Direct (cooling)
rEu Reverse (heating)

This determines the control action for the PID loop. Programmed for direct action (cooling), the output power will increase if the Process value is above the Setpoint value. Programmed for reverse action (heating), the output power decreases when the Process Value is above the Setpoint Value. For heat and cool applications, this is typically set to reverse. This allows O1 or A1 (models with Analog Output) to be used for heating, and A2/O2 to be used for cooling.

OUTPUT POWER LOWER LIMIT

OPLD
0

0 to 100 percent O1
-100 to 100 percent O1/O2

This parameter may be used to limit controller power at the lower end due to process disturbances or setpoint changes. Enter the safe output power limits for the process. If Alarm 2 is selected for cooling, the range is from -100 to +100%. At 0%, both O1 and O2 are off; at 100%, O1 is on; and at -100%, O2 is on. When the controller is in Manual Control Mode, this limit does not apply.

OUTPUT POWER UPPER LIMIT

OPHI
100

0 to 100 percent O1
-100 to 100 percent O1/O2

This parameter may be used to limit controller power at the upper end due to process disturbances or setpoint changes. Enter the safe output power limits for the process. If Alarm 2 is selected for cooling, the range is from -100 to +100%. At 0%, both O1 and O2 are off; at 100%, O1 is on; and at -100%, O2 is on. When the controller is in Manual Control Mode, this limit does not apply.

SENSOR FAIL POWER LEVEL

OPFL
0

0 to 100 percent O1
-100 to 100 percent O1/O2

This parameter sets the power level for the control outputs in the event of a sensor failure. If Alarm 2 is not selected for cooling, the range is from 0% (O1 output full off) to 100% (O1 output full on). If A2 is selected for cooling, the range is from -100 to +100%. At 0%, both O1 and O2 are off; at 100%, O1 is on; and at -100%, O2 is on. The alarm outputs are upscale drive with an open sensor, and downscale drive with a shorted sensor (RTD only), independent of this setting. Manual Control overrides the sensor fail preset.

OUTPUT POWER DAMPENING

OPDP
3
1

0 to 250 seconds

The Dampening Time, entered as a time constant in seconds, dampens (filters) the calculated output power. Increasing the value increases the dampening effect. Generally, dampening times in the range of one-twentieth to one-fiftieth of the controller's integral time (or process time constant) are effective. Dampening times longer than these may cause controller instability due to the added lag effect.

ON/OFF CONTROL HYSTERESIS

CHYS
2
0.2

1 to 250

The controller can be placed in the On/Off Control Mode by setting the Proportional Band to 0.0%. The On/Off Control Hysteresis (balanced around the setpoint) eliminates output chatter. In heat/cool applications, the control hysteresis value affects both Output O1 and Output O2 control. It is suggested to set the hysteresis band to Factory Setting prior to starting Auto-Tune. After Auto-Tune, the hysteresis band has no effect on PID Control. On/Off Control Hysteresis is illustrated in the On/Off Control Mode section.

AUTO-TUNE CODE

tcod
0

0 fastest to 2 slowest

Prior to starting Auto-Tune, this code should be set to achieve the necessary dampening level under PID Control. This value allows customization of the PID values that Auto-Tune will calculate. For the process to be controlled aggressively (fastest process response with possible overshoot), set the Auto-Tune Code to 0. For the process to be controlled conservatively (slowest response with the least amount of overshoot), set this value to 2. If the Auto-Tune Code is changed, Auto-Tune needs to be reinitiated for the changes to affect the PID settings. For more information, see PID Tuning Explanations Section.

ANALOG OUTPUT RANGE (OPTIONAL)

ANLOR 0-10 V 0-20 mA
4-20 4-20 mA

Select the type of output and range. The Analog output jumpers are factory set to current. They must be changed if voltage output is desired. The Analog output can be calibrated to provide up to approximately 5% over range operation (0 mA current can only go slightly negative).

ANALOG OUTPUT ASSIGNMENT (OPTIONAL)

ANNS OP Main Control % Output Power
OP InP Input Signal Retransmission
 SP Active Setpoint

This setting selects the parameter that the Analog Output will retransmit or track.

ANALOG UPDATE TIME (OPTIONAL)

ANUL 0 to 250 seconds
 0 = update rate of 0.1 second

The update time of the Analog Output can be used to reduce excess valve actuator or pen recorder activity.

ANALOG LOW SCALING (OPTIONAL)

ANLO -999 to 9999
 0.0

The Analog Output assignment value that corresponds to 0 V, 0 mA or 4 mA output as selected.

ANALOG HIGH SCALING (OPTIONAL)

ANH -999 to 9999
 100.0

The Analog Output assignment value that corresponds to 10 V or 20 mA output as selected. An inverse acting output can be achieved by reversing the low and high scaling points.

7.3 MODULE 3 - LOCKOUT PARAMETERS (3-LL)

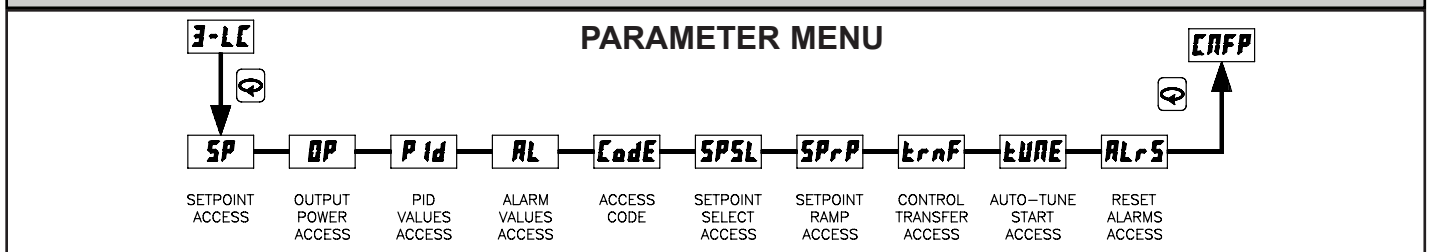

SELECTION	DESCRIPTION
dISP	Display: accessible in Display Loop.
HiDE	Hide: accessible in Hidden Loop.
LOC	Locked: not accessible in either loop.
dSPr (SP only)	Display/read: read only in Display Loop, but read/write in Hidden Loop.

The following parameters can be configured for LOC, HiDE, and dISP.

SETPOINT ACCESS SP dISP	OUTPUT POWER ACCESS OP dISP	PID VALUES ACCESS PId HiDE	ALARM VALUES ACCESS AL HiDE
--------------------------------------	--	---	--

ACCESS CODE

CodE -125 to 125
 0

0	Full access to Display, Hidden, and Configuration Loops
-1 to -125	Code necessary to access Configuration Loop only.
1 to 125	Code necessary to access Hidden and Configuration Loops.

The following parameters can be configured for LOC or HiDE only.

SETPOINT SELECT ACCESS SPsL LOC	SETPOINT RAMP ACCESS SPrP HiDE	CONTROL TRANSFER ACCESS trnF LOC
AUTO-TUNE START ACCESS tUNE HiDE	RESET ALARMS ACCESS ALrS LOC	

7.4 MODULE 4 - ALARM PARAMETERS (4-AL) (OPTIONAL)

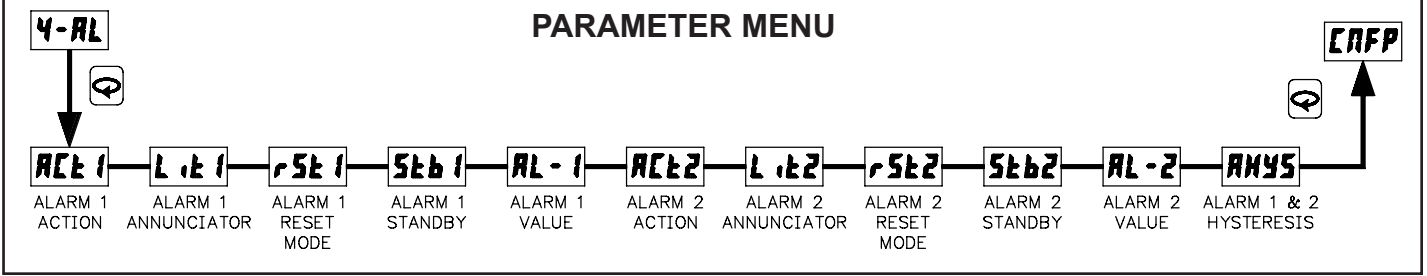

AVAILABLE ALARM ACTIONS

None	None	No action, the remaining Alarm parameters are not available.
RbH1	Absolute High (balanced hysteresis)	The alarm energizes when the Process Value exceeds the alarm value + 1/2 the hysteresis value.
RbL0	Absolute Low (balanced hysteresis)	The alarm energizes when the Process Value falls below the alarm value -1/2 the hysteresis value.
RuH1	Absolute High (unbalanced hysteresis)	The alarm energizes when the Process Value exceeds the alarm value.
RuL0	Absolute Low (unbalanced hysteresis)	The alarm energizes when the Process Value falls below the alarm value.

d-H1	Deviation High	Alarm 1 and 2 value tracks the Setpoint value
d-L0	Deviation Low	Alarm 1 and 2 value tracks the Setpoint value
b-in	Band Acting (inside)	Alarm 1 and 2 value tracks the Setpoint value
b-out	Band Acting (outside)	Alarm 1 and 2 value tracks the Setpoint value
HEAt	Heat (A1 Analog models only)	If heating is selected, the remaining Alarm 1 parameters are not available.
Cool	Cool (A2 only)	If cooling is selected, the remaining Alarm 2 parameters are not available.

ALARM ACTION FIGURES

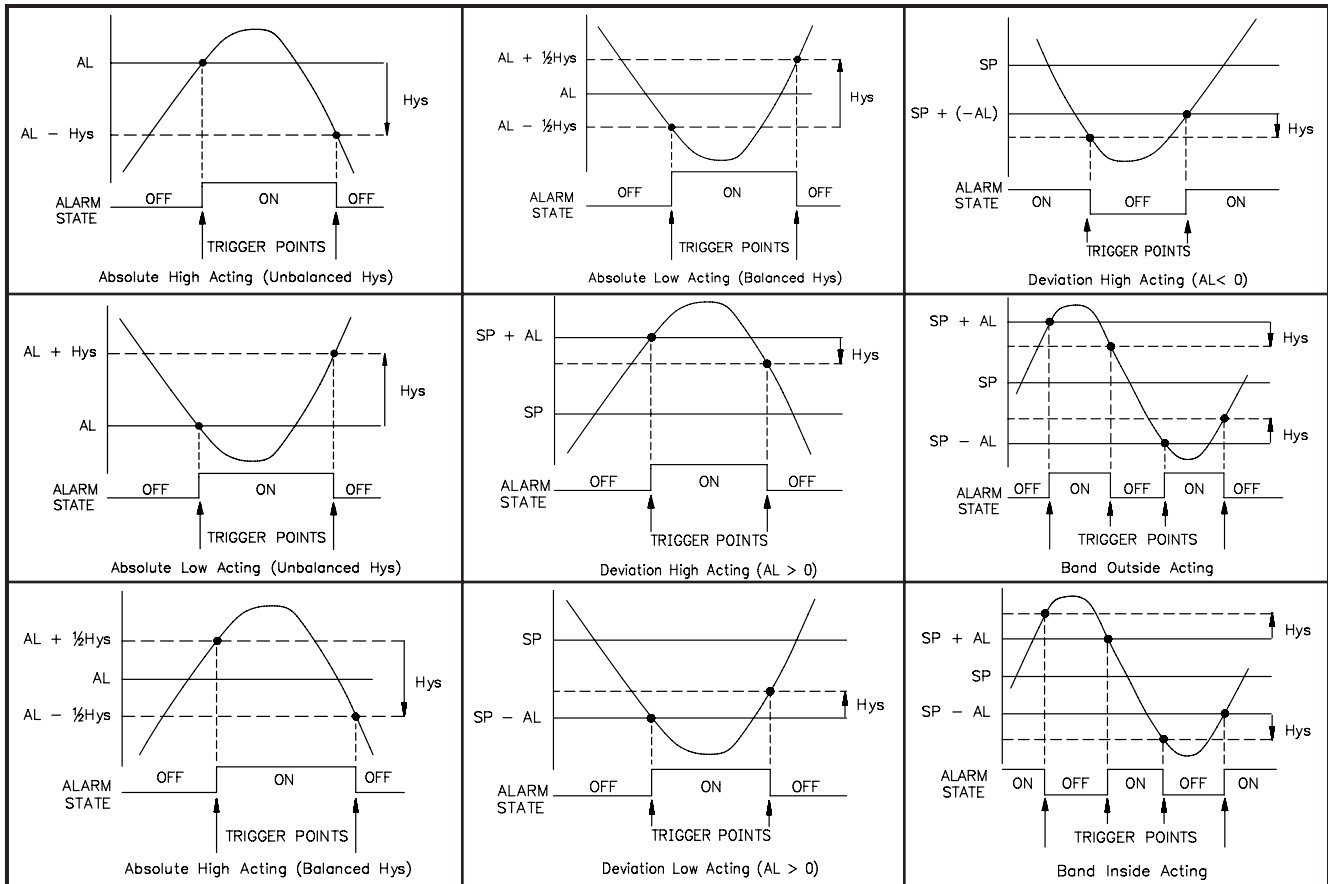

Note: Hys in the above figures refers to the Alarm Hysteresis.

ALARM ACTION ALARM 1

AL-1	NONE ABHI ABLO AUHI AULO
AUH1	d-H1 d-LO b-IN b-out HERE

Select the action for the alarms. See Alarm Action Figures for a visual explanation.

ALARM ANNUNCIATOR ALARM 1

L-1	nor Normal
nor	rev Reverse

With normal selection, the alarm annunciator indicates “on” alarm output 1. With reverse selection, the alarm annunciator indicates “off” alarm output.

ALARM RESET MODE ALARM 1

r-1	Auto Automatic
AUTO	Latched

In Automatic mode, an energized alarm turns off automatically after the Temperature/Process value leaves the alarm region. In Latched mode, an energized alarm requires an F1 key or user input alarm reset to turn off. After an alarm reset, the alarm remains reset off until the trigger point is crossed again.

ALARM STANDBY ALARM 1

S-1	YES Standby on
NO	Standby off

Standby prevents nuisance (typically low level) alarms after a power up or setpoint change. After powering up the controller or changing the setpoint, the process must leave the alarm region (enter normal non-alarm area of operation). After this has occurred, the standby is disabled and the alarm responds normally until the next controller power up or setpoint change.

ALARM VALUE ALARM 1

AL-1	-999 to 9999
0	T16
0.0	P16

The alarm values are entered as process units or degrees. They can also be entered in the Display or Hidden Loops. When the alarm is configured as deviation or band acting, the associated output tracks the Setpoint as it is changed. The value entered is the offset or difference from the Setpoint.

ALARM ACTION ALARM 2

AL-2	NONE ABHI ABLO AUHI AULO
AUH1	d-H1 d-LO b-IN b-out Cool

Select the action for the alarms. See Alarm Action Figures for a visual explanation.

ALARM ANNUNCIATOR ALARM 2

L-2	nor Normal
nor	rev Reverse

With normal selection, the alarm annunciator indicates “on” alarm output 2. With reverse selection, the alarm annunciator indicates “off” alarm output.

ALARM RESET MODE ALARM 2

r-2	Auto Automatic
AUTO	Latched

In Automatic mode, an energized alarm turns off automatically after the Temperature/Process value leaves the alarm region. In Latched mode, an energized alarm requires an F1 key or user input alarm reset to turn off. After an alarm reset, the alarm remains reset off until the trigger point is crossed again.

ALARM STANDBY ALARM 2

S-2	YES Standby on
NO	Standby off

Standby prevents nuisance (typically low level) alarms after a power up or setpoint change. After powering up the controller or changing the setpoint, the process must leave the alarm region (enter normal non-alarm area of operation). After this has occurred, the standby is disabled and the alarm responds normally until the next controller power up or setpoint change.

ALARM VALUE ALARM 2

AL-2	-999 to 9999
20	T16
2.0	P16

The alarm values are entered as process units or degrees. They can also be entered in the Display or Hidden Loops. When the alarm is configured as deviation or band acting, the associated output tracks the Setpoint as it is changed. The value entered is the offset or difference from the Setpoint.

ALARM HYSTERESIS

AHYS	0 to 250
1	T16
0.1	P16

The Hysteresis Value is either added to or subtracted from the alarm value, depending on the alarm action selected. The same value applies to both alarms. See the Alarm Action Figures for a visual explanation of how alarm actions are affected by the hysteresis.

7.5 MODULE 5 - COOLING (SECONDARY) PARAMETERS (5-02)

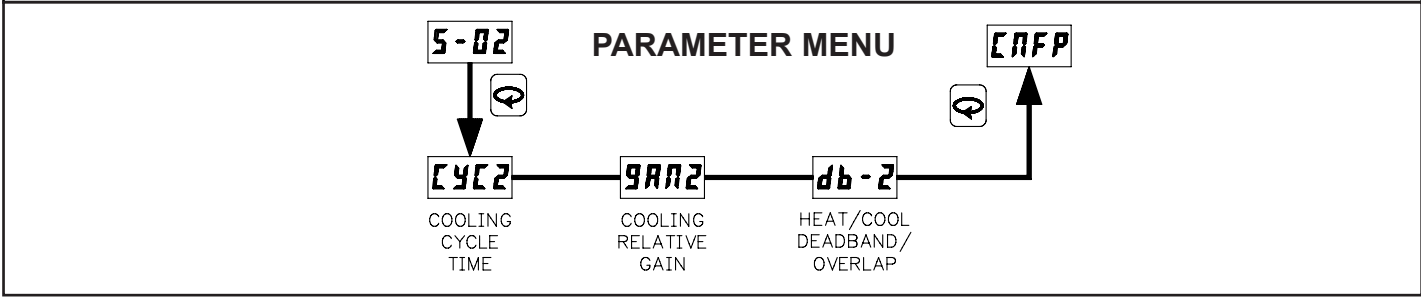

To enable Cooling in Heat/Cool applications, the Alarm 2 Action must first be set for Cooling. (For P16 Controllers, the cooling output is sometimes referred to as secondary output.) When set to cooling, the output no longer operates as an alarm but operates as a cooling output. The O2 terminals are the same as A2, however a separate O2 annunciator indicates Cooling Operation. Cooling output power ranges from -100% (full cooling) to 0% (no cooling, unless a heat/cool overlap is used). The Power Limits in Output Module 2-0P also limit the cooling power. In applications requiring only a Cooling output, the main O1 output should be used.

CYCLE TIME

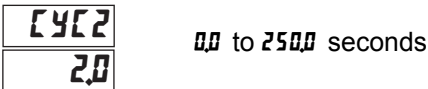

This cycle time functions like the O1 Output Cycle Time but allows independent cycle time for cooling. A setting of zero will keep output O2 off.

RELATIVE GAIN



This defines the gain of the cooling relative to the heating. It is generally set to balance the effects of cooling to that of heating. This is illustrated in the Heat/Cool Relative Gain Figures. A value of 0.0 places the cooling output into On/Off Control.

DEADBAND/OVERLAP

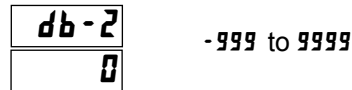

This defines the overlap area in which both heating and cooling are active (negative value) or the deadband area between the bands (positive value). If a heat/cool overlap is specified, the percent output power is the sum of the heat power (O1) and the cool power (O2). If Relative Gain is zero, the cooling output operates in the On/Off Control Mode, with the On/Off Control Hysteresis CN45 in Output Module 2-0P becoming the cooling output hysteresis. The function of Deadband is illustrated in the Control Mode Explanations. For most applications, set this parameter to 0.0 prior to starting Auto-Tune. After the completion of Auto-Tune, this parameter may be changed.

HEAT/COOL RELATIVE GAIN FIGURES

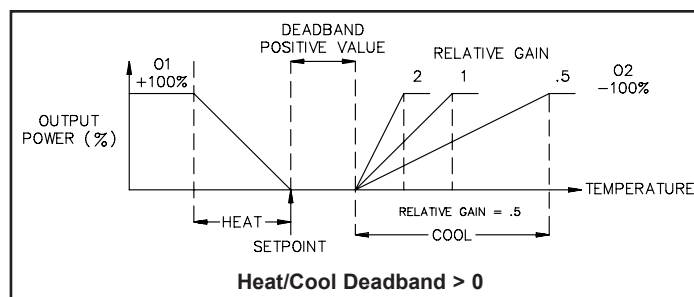
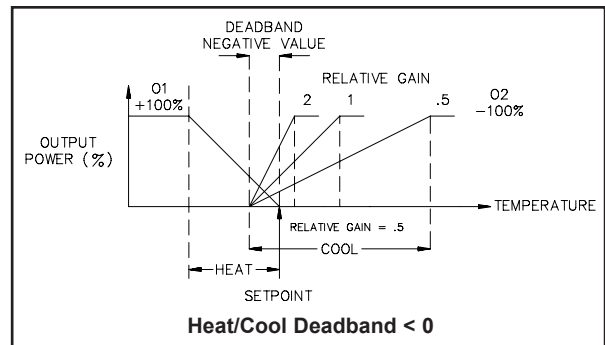
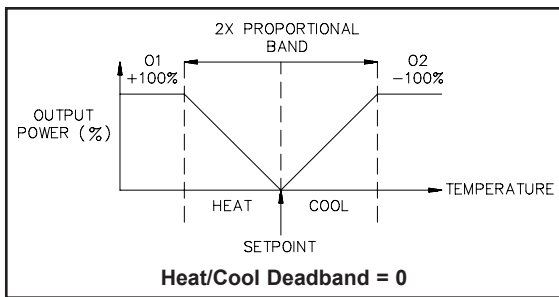

7.5 MODULE 9 FACTORY SERVICE OPERATIONS (9-F5)

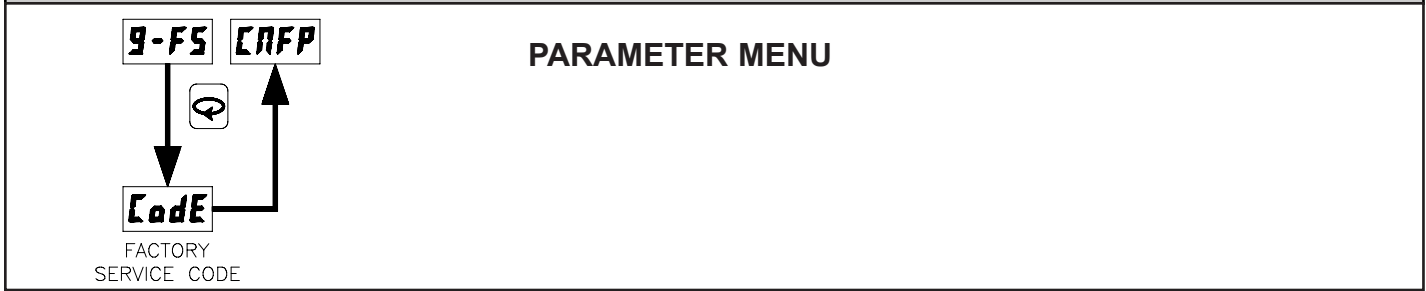

CALIBRATION

Code
4B

The controller is fully calibrated from the factory. Recalibration is recommended every two years by qualified technicians using appropriate equipment. Calibration may be performed by using the front panel or with the TP16KIT. The front panel method is explained below. (Refer to the TP16KIT bulletin for calibration instructions using TP16KIT cable and software.)

Calibration may be aborted by disconnecting power to the controller before exiting Factory Service Module 9-F5. In this case, the existing calibration settings remain in effect.

Note: Allow the controller to warm up for 30 minutes minimum and follow the manufacturer's warm-up recommendations for the calibration source or measuring device.

Millivolt Calibration (T16)

Millivolt calibration requires a precision voltage source with an accuracy of 0.03% (or better) connected to terminals 8 (comm.) and 9 (+). When calibrating the input, the millivolt calibration must be performed first, then the Cold Junction or RTD Resistance.

PROMPT	APPLY	FRONT PANEL ACTION
Code		Press ▼ until 4B , press ⏏ .
CRL		Press ▲ for YE5 , press ⏏ .
5tP1	0.0 mV	After 5 seconds (minimum), press ⏏ .
5tP2	14.0 mV	After 5 seconds (minimum), press ⏏ .
5tP3	28.0 mV	After 5 seconds (minimum), press ⏏ .
5tP4	42.0 mV	After 5 seconds (minimum), press ⏏ .
5tP5	56.0 mV	After 5 seconds (minimum), press ⏏ .

Cold Junction (T16)

Cold Junction calibration requires a thermocouple of known accuracy of types T, E, J, K, C or N (connected to terminals 8 and 9) and a calibrated external reference thermocouple probe measuring in °C with resolution to tenths. The two probes should be brought in contact with each other or in some way held at the same temperature. They should be shielded from air movement and allowed sufficient time to equalize in temperature. (As an alternative, the T16 thermocouple may be placed in a calibration bath of known temperature.) If performing the millivolt calibration prior, verify that the correct input type is configured in Input Module *t-#* before performing the following procedure. (After the millivolt calibration the controller will default to type J.) If using RTD only, the cold junction calibration need not be performed.

PROMPT	COMPARE	FRONT PANEL ACTION
Code		Press ▼ until 4B , press ⏏ .
CRL		Press ⏏ .
CJC		Press ▲ for YE5 , press ⏏ .
	Top display to external reference	Press ▲ or ▼ to adjust the bottom display until the top process display matches the external reference then press ⏏ .

RTD Resistance (T16)

RTD calibration requires a precision 277.0 ohm resistor with an accuracy of 0.1 Ω (or better). Connect a jumper between terminals 9 and 10 with a 0 ohm jumper between 9 and 8 at **5tP1** and the 277.0 ohm resistor between 9 and 8 at **5tP2**. If using thermocouple only, the RTD calibration need not be performed.

PROMPT	APPLY	FRONT PANEL ACTION
Code		Press ▼ until 4B , press ⏏ .
CRL		Press ⏏ .
CJC		Press ⏏ .
rtd		Press ▲ for YE5 , press ⏏ .
5tP1	0.0 ohm	After 5 seconds (minimum), press ⏏ .
5tP2	277.0 ohm	After 5 seconds (minimum), press ⏏ .

Input Calibration (P16)

Process calibration requires a precision signal source with an accuracy of 0.03% (or better) that is capable of generating 10.0 V connected to terminals 8 (COMM) and 9 (+10V) and 20.00 mA connected to terminals 8 (COMM) and 10 (20mA). The current calibration can be skipped by pressing **⏏** at the not applicable prompts if using the controller for process voltage only.

PROMPT	APPLY	FRONT PANEL ACTION
Code		Press ▼ until 4B , press ⏏ .
CRL		Press ▲ for YE5 , press ⏏ .
5tP1	0.0 V	After 5 seconds (minimum), press ⏏ .
5tP2	2.5 V	After 5 seconds (minimum), press ⏏ .
5tP3	5.0 V	After 5 seconds (minimum), press ⏏ .
5tP4	7.5 V	After 5 seconds (minimum), press ⏏ .
5tP5	10.0 V	After 5 seconds (minimum), press ⏏ .
5tP6	0.0 mA	After 5 seconds (minimum), press ⏏ .
5tP7	20.0 mA	After 5 seconds (minimum), press ⏏ .

Analog Output Calibration (T16 and P16)

Set the controller Analog jumpers to the output type being calibrated. Connect an external meter with an accuracy of 0.05% (or better) that is capable of measuring 10.00 V or 20.00 mA to terminals 6 (+V/I) and 7 (-V/I). The voltage or current calibration that is not being used must be skipped by pressing \square until End appears.

PROMPT	EXTERNAL METER	FRONT PANEL ACTION
Code		Press \downarrow until 48 , press \square .
RL		Press \square .
d		Press \square . (T16 only)
rtd		Press \square . (T16 only)
ANCL		Press \uparrow for 4E5 , press \square .
0u	0.00 V	Press \uparrow or \downarrow until external meter matches listing, press \square .
10u	10.00 V	Press \uparrow or \downarrow until external meter matches listing, press \square .
0c	0.00 mA	Press \uparrow or \downarrow until external meter matches listing, press \square .
20c	20.00 mA	Press \uparrow or \downarrow until external meter matches listing, press \square .

RESTORE FACTORY SETTINGS

Code
 55

Press and hold \uparrow to display Code 55 . Press \square . The controller will display r5E4 and then return to ANFP . Press \square to return to the Display Loop. This will overwrite all user settings with Factory Settings.

NOMINAL CALIBRATION SETTINGS

Code
 77

Press and hold \uparrow to display Code 77 . Press \square . Press and hold \uparrow to display Code 77 again. Press \square . The controller will then return to ANFP . Press \square to return to the Display Loop. This will not overwrite any user settings but will erase the controller calibration values. This procedure does not require any calibration signals nor external meters. This can be used to clear calibration error flag E-EL .

CAUTION: This procedure will result in up to $\pm 10\%$ reading error and the controller will no longer be within factory specifications. For this reason, this procedure should only be performed if meter error is outside of this range to temporarily restore operation until the unit can be accurately calibrated.

TROUBLESHOOTING

For further technical assistance, contact technical support.

PROBLEM	CAUSE	REMEDIES
NO DISPLAY	<ol style="list-style-type: none"> Power off. Brown-out condition. Loose connection or improperly wired. Bezel assembly not fully seated into rear of controller. 	<ol style="list-style-type: none"> Check power. Verify power reading. Check connections. Check installation.
CONTROLLER NOT WORKING	<ol style="list-style-type: none"> Incorrect setup parameters. 	<ol style="list-style-type: none"> Check setup parameters.
E-E2 IN DISPLAY	<ol style="list-style-type: none"> Loss of setup parameters due to noise spike or other EMI event. 	<ol style="list-style-type: none"> Press F1 to escape, then check all setup parameters. <ol style="list-style-type: none"> Check sensor input and AC line for excessive noise. If fault persists, replace controller.
E-EL IN DISPLAY	<ol style="list-style-type: none"> Loss of calibration parameters due to noise spike or other EMI event. 	<ol style="list-style-type: none"> Press F1 to escape, then check controller accuracy. <ol style="list-style-type: none"> Recalibrate controller. (See Factory Service Module code 77.) Reset parameters to factory default settings.
dddd or -ddd IN DISPLAY	<ol style="list-style-type: none"> Display value exceeds 4 digit display range. Defective or miscalibrated cold junction circuit. Loss of setup parameters. Internal malfunction. 	<ol style="list-style-type: none"> Change resolution to display whole number and verify reading. Perform cold junction calibration. Check setup parameters. Perform Input calibration.
OPEN IN DISPLAY (T16)	<ol style="list-style-type: none"> Probe disconnected. Broken or burned-out probe. Corroded or broken terminations. Excessive process temperature. 	<ol style="list-style-type: none"> Connect probe. Replace probe. Check connections. Check process parameters.
5E45 IN DISPLAY (P16)	<ol style="list-style-type: none"> Input exceeds range of controller. Incorrect input wiring. Defective transmitter. Internal malfunction. 	<ol style="list-style-type: none"> Check input parameters. Check input wiring. Replace transmitter. Perform input calibration.
ULUL IN TOP DISPLAY	<ol style="list-style-type: none"> Input exceeds range of controller. Temperature exceeds range of input probe. Defective or incorrect transmitter or probe. Excessive high temperature for probe. Loss of setup parameters. 	<ol style="list-style-type: none"> Check input parameters. Change to input sensor with a higher temperature range. Replace transmitter or probe. Reduce temperature. Perform input calibration.
ULUL IN TOP DISPLAY	<ol style="list-style-type: none"> Input is below range of controller. Temperature below range of input probe. Defective or incorrect transmitter or probe. Excessive low temperature for probe. Loss of setup parameters. 	<ol style="list-style-type: none"> Check input parameters. Change to input sensor with a lower temperature range. Replace transmitter or probe. Raise temperature. Perform input calibration.
5HrE IN DISPLAY (T16)	<ol style="list-style-type: none"> RTD probe shorted. 	<ol style="list-style-type: none"> Check wiring and/or replace RTD probe.
CONTROLLER SLUGGISH OR NOT STABLE	<ol style="list-style-type: none"> Incorrect PID values. Incorrect probe location. 	<ol style="list-style-type: none"> See PID control. Evaluate probe location.

CONTROL MODE EXPLANATIONS

ON/OFF CONTROL

The controller operates in On/Off Control when the Proportional Band is set to 0.0%. In this control mode, the process will constantly oscillate around the setpoint value. The On/Off Control Hysteresis (balanced around the setpoint) can be used to eliminate output chatter. Output O1 Control Action can be set to reverse for heating (output on when below the setpoint) or direct for cooling (output on when above the setpoint) applications.

ON/OFF CONTROL - REVERSE OR DIRECT ACTING FIGURES

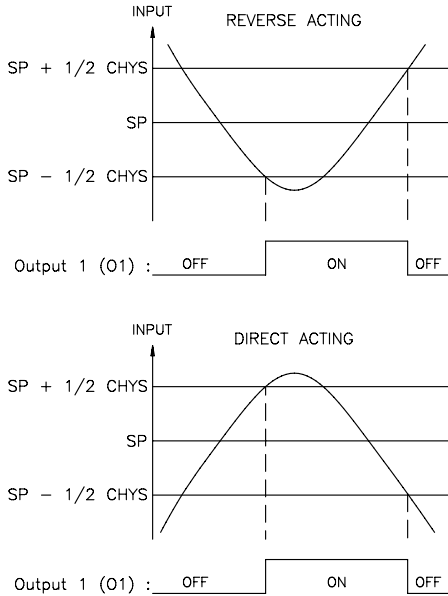

Note: CHYS in the On/Off Control Figures refers to the On/Off Control Hysteresis (CHYS) in parameter Module 2.

For heat and cool systems, O1 Control Action is set to reverse (heat) and the Alarm 2 Action is set to cooling (O2). The Proportional Band is set to 0.0 and the Relative Gain in Cooling to 0.0. The Deadband in Cooling sets the amount of operational deadband or overlap between the outputs. The setpoint and the On/Off Control Hysteresis applies to both O1 and O2 outputs. The hysteresis is balanced in relationship to the setpoint and deadband value.

ON/OFF CONTROL - HEAT/COOL OUTPUT FIGURES

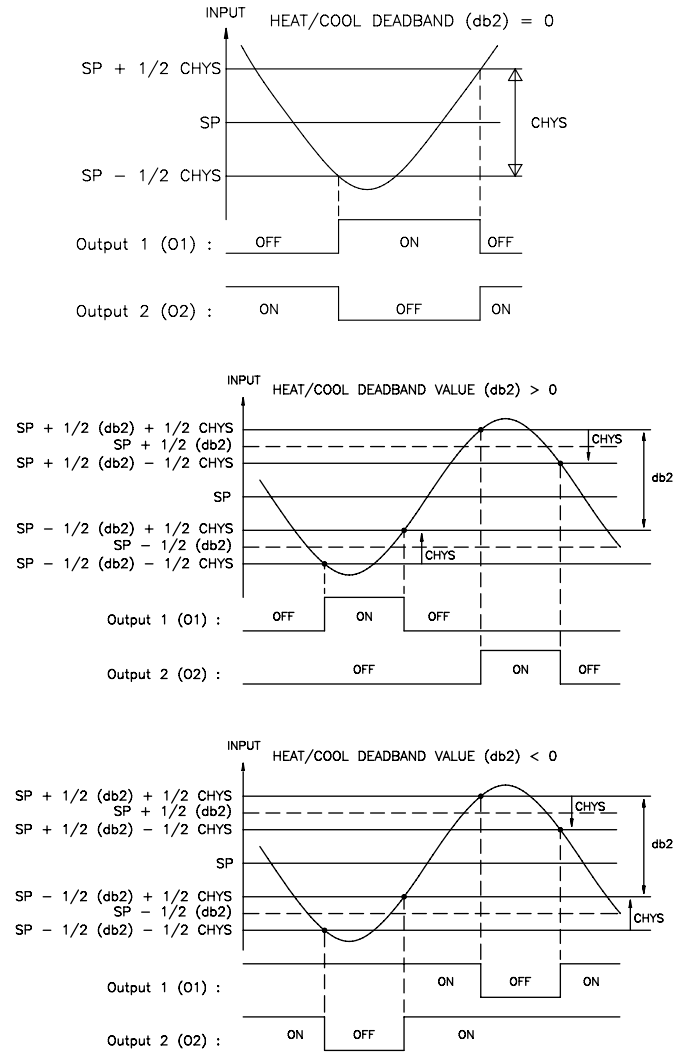

PID CONTROL

In PID Control, the controller processes the input and then calculates a control output power value by use of a modified Proportional Band, Integral Time, and Derivative Time control algorithm. The system is controlled with the new output power value to keep the process at the setpoint. The Control Action for PID Control can be set to reverse for heating (output on when below the setpoint) or direct for cooling (output on when above the setpoint) applications. For heat and cool systems, the heat (O1) and cool (O2) outputs are both used. The PID parameters can be established by using Auto-Tune, or they can be Manually tuned to the process.

TYPICAL PID RESPONSE CURVE

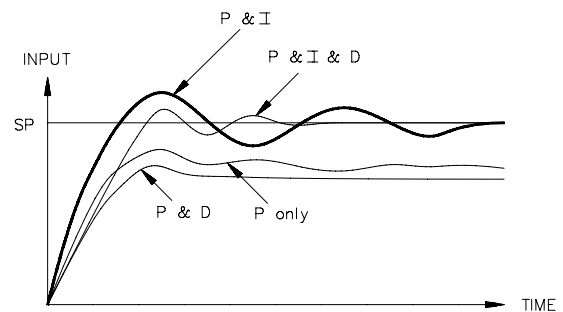

TIME PROPORTIONAL PID CONTROL

In Time Proportional applications, the output power is converted into output On time using the Cycle Time. For example, with a four second cycle time and 75% power, the output will be on for three seconds (4×0.75) and off for one second.

The cycle time should be no greater than 1/10 of the natural period of oscillation for the process. The natural period is the time it takes for one complete oscillation when the process is in a continuously oscillating state.

LINEAR PID CONTROL

In Linear PID Control applications, the Analog Output Assignment **ANAS** is set to % Output Power, **OP**. The Analog Low Scaling, **ANLB**, is set to 0.0 and the Analog High Scaling, **ANHI**, is set to 100.0. The Analog Output will then be proportional to the PID calculated % output power for Heat or Cooling per the Control Action **OPRC**. For example, with 0 VDC to 10 VDC (scaled 0 to 100%) and 75% power, the analog output will be 7.5 VDC.

MANUAL CONTROL MODE

In Manual Control Mode, the controller operates as an open loop system (does not use the setpoint and process feedback). The user adjusts the percentage of power through the % Power display to control the power for Output O1. When Alarm 2 is configured for Cooling (O2), Manual operation provides 0 to 100% power to O1 (heating) and -100 to 0% power to O2 (Cooling). The Low and High Output Power limits are ignored when the controller is in Manual.

MODE TRANSFER

When transferring the controller mode between Automatic and Manual, the controlling outputs remain constant, exercising true "bumpless" transfer. When transferring from Manual to Automatic, the power initially remains steady, but Integral Action corrects (if necessary) the closed loop power demand at a rate proportional to the Integral Time.

AUTOMATIC CONTROL MODE

In Automatic Control Mode, the percentage of output power is automatically determined by PID or On/Off calculations based on the setpoint and process feedback. For this reason, PID Control and On/Off Control always imply Automatic Control Mode.

PID TUNING EXPLANATIONS

AUTO-TUNE

Auto-Tune is a user-initiated function that allows the controller to automatically determine the Proportional Band, Integral Time, Derivative Time, Digital Filter, Control Output Dampening Time, and Relative Gain (Heat/Cool) values based upon the process characteristics. The Auto-Tune operation cycles the controlling output(s) at a control point three-quarters of the distance between the present process value and the setpoint. The nature of these oscillations determines the settings for the controller's parameters.

Prior to initiating Auto-Tune, it is important that the controller and system be first tested. (This can be accomplished in On/Off Control or Manual Control Mode.) If there is a wiring, system or controller problem, Auto-Tune may give incorrect tuning or may never finish. Auto-Tune may be initiated at start-up, from setpoint or at any other process point. However, ensure normal process conditions (example: minimize unusual external load disturbances) as they will have an effect on the PID calculations.

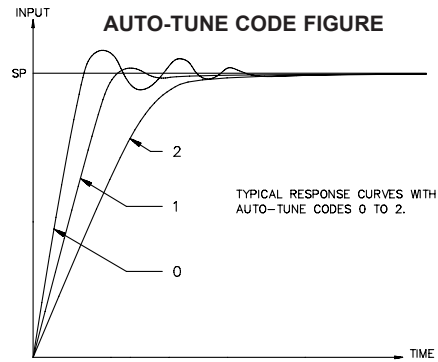

Start Auto-Tune

Below are the parameters and factory settings that affect Auto-Tune. If these setting are acceptable then Auto-Tune can be started just by performing two steps. If changes are needed, then they must be made before starting Auto-Tune.

DISPLAY	PARAMETER	FACTORY SETTING	MODULE
TYPE	Input Type	T16 T16 P16 P16	1-11
FLTR	Digital Filtering	1	1-11
CHYS	On/Off Control Hysteresis	2 T16 0.2 P16	2-02
TCOD	Auto-Tune Code	0	2-02
DB-2	Deadband	0	5-02
ATNE	Auto-Tune Access	HIDE	3-11

1. Enter the Setpoint value in the Display Loop.
2. Initiate Auto-Tune by changing Auto-Tune Start **ATNE** to **YES** in the Hidden Loop.

Auto-Tune Progress

The controller will oscillate the controlling output(s) for four cycles. The bottom display will flash the cycle phase number. Parameter viewing is permitted during Auto-Tune. The time to complete the Auto-Tune cycles is process dependent. The controller should automatically stop Auto-Tune and store the calculated values when the four cycles are complete. If the controller remains in Auto-Tune unusually long, there may be a process problem. Auto-Tune may be stopped by entering **NO** in Auto-Tune Start **ATNE**.

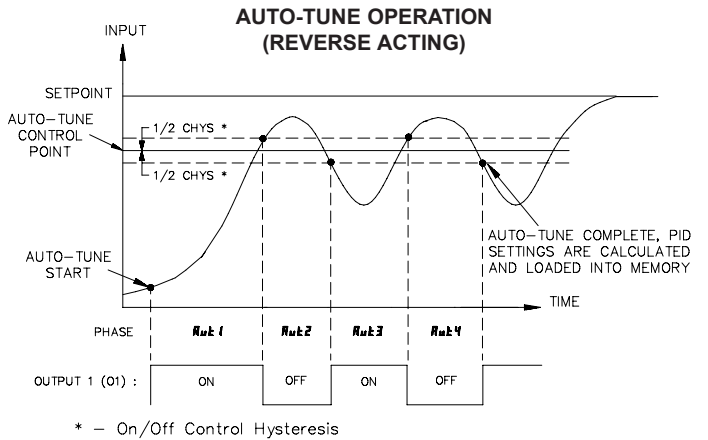

PID Adjustments

In some applications, it may be necessary to fine tune the Auto-Tune calculated PID parameters. To do this, a chart recorder or data logging device is needed to provide a visual means of analyzing the process. Compare the actual process response to the PID response figures with a step change to the process. Make changes to the PID parameters in no more than 20% increments from the starting value and allow the process sufficient time to stabilize before evaluating the effects of the new parameter settings.

In some unusual cases, the Auto-Tune function may not yield acceptable control results or induced oscillations may cause system problems. In these applications, Manual Tuning is an alternative.

PROCESS RESPONSE EXTREMES

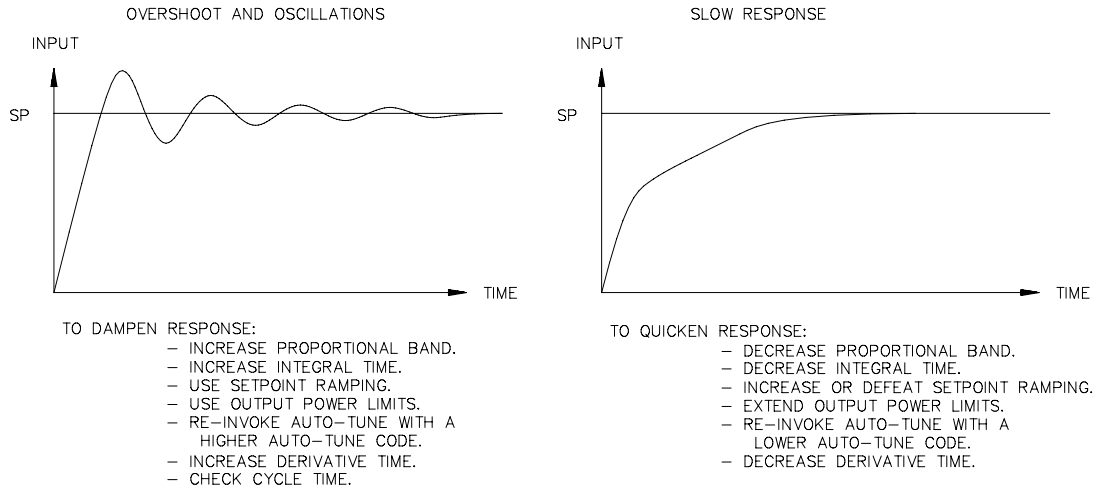

MANUAL TUNING

A chart recorder or data logging device is necessary to measure the time between process cycles. This procedure is an alternative to the controller's Auto-Tune function. It will not provide acceptable results if system problems exist.

1. Set the Proportional Band (P_{rpb}) to 10.0% for temperature models (T16) and 100.0% for process models (P16).
2. Set both the Integral Time ($Intk$) and Derivative Time ($dErk$) to 0 seconds.
3. Set the Output Dampening Time ($OPdP$) in Output Module 2- OP to 0 seconds.
4. Set the Output Cycle Time [CYCt] in Output Module 2- OP to no higher than one-tenth of the process time constant (when applicable).
5. Place the controller in Manual $USER$ Control Mode $trnF$ in the Hidden Loop and adjust the % Power to drive the process value to the Setpoint value. Allow the process to stabilize after setting the % Power. Note: $trnF$ must be set to $H.dE$ in Parameter Lockouts Module 3- LL .
6. Place the controller in Automatic ($Auto$) Control Mode $trnF$ in the Hidden Loop. If the process will not stabilize and starts to oscillate, set the Proportional Band two times higher and go back to Step 5.
7. If the process is stable, decrease Proportional Band setting by two times and change the Setpoint value a small amount to excite the process. Continue with this step until the process oscillates in a continuous nature.
8. Fix the Proportional Band to three times the setting that caused the oscillation in Step 7.
9. Set the Integral Time to two times the period of the oscillation.
10. Set the Derivative Time to 1/8 (0.125) of the Integral Time.
11. Set the Output Dampening Time to 1/40 (0.025) the period of the oscillation.

PARAMETER VALUE CHART

Programmer: _____ **Date:** _____

Controller Number: _____ **Security Code:** _____

DISPLAY LOOP

DISPLAY	PARAMETER	FACTORY SETTING	USER SETTING
SP	SETPOINT VALUE SP1	0 T16 00 P16	_____
SP	SETPOINT VALUE SP2	20 T16 20 P16	_____
OP	OUTPUT POWER PERCENT	00	_____
PrOP *	PROPORTIONAL BAND	40 T16 1000 P16	_____
Intt *	INTEGRAL TIME	120 T16 40 P16	_____
dErt *	DERIVATIVE TIME	30 T16 4 P16	_____
AL-1 *	ALARM 1 VALUE	0	_____
AL-2 *	ALARM 2 VALUE	0	_____

* Factory Setting places these parameters in the Hidden Loop (set to HIDE in Lockout Module 3-LC).

OUTPUT MODULE (2-OP)

DISPLAY	PARAMETER	FACTORY SETTING	USER SETTING
CYCL	CYCLE TIME	20	_____
OPAC	CONTROL ACTION	REV	_____
OPLO	OUTPUT POWER LOWER LIMIT	0	_____
OPHI	OUTPUT POWER UPPER LIMIT	100	_____
OPFL	SENSOR FAIL POWER PRESET	0	_____
OPdP	OUTPUT POWER DAMPENING	3 T16 1 P16	_____
CHYS	ON/OFF CONTROL HYSTERESIS	2 T16 0.2 P16	_____
tcod	AUTO-TUNE CODE	0	_____
ANtP	ANALOG OUTPUT RANGE	4-20	_____
ANAS	ANALOG OUTPUT ASSIGNMENT	OP	_____
ANUt	ANALOG UPDATE TIME	0	_____
ANLO	ANALOG LOW SCALING	00	_____
ANHI	ANALOG HIGH SCALING	1000	_____

HIDDEN LOOP

DISPLAY	PARAMETER	FACTORY SETTING	USER SETTING
SPSL	SETPOINT SELECT	SP1	_____
SPrP	SETPOINT RAMP RATE	00	_____
trnF	CONTROL MODE TRANSFER	Auto	_____
tUNE	AUTO-TUNE START	NO	_____

LOCKOUT MODULE (3-LC)

DISPLAY	PARAMETER	FACTORY SETTING	USER SETTING
SP	SETPOINT ACCESS	DISP	_____
OP	OUTPUT POWER ACCESS	DISP	_____
PId	PID VALUE ACCESS	HIDE	_____
AL	ALARM VALUE ACCESS	HIDE	_____
codE	ACCESS CODE	0	_____
SPSL	SETPOINT SELECT ACCESS	LOC	_____
SPrP	SETPOINT RAMP ACCESS	HIDE	_____
trnF	TRANSFER CONTROL ACCESS	LOC	_____
tUNE	AUTO-TUNE ACCESS	HIDE	_____
ALrS	RESET ALARMS ACCESS	LOC	_____

INPUT MODULE (1-IN) T16 ONLY

DISPLAY	PARAMETER	FACTORY SETTING	USER SETTING
tYPE	INPUT TYPE	tc-d	_____
SCAL	TEMPERATURE SCALE	OF	_____
dCPt	DECIMAL RESOLUTION	0	_____
FLtr	DIGITAL FILTERING	1	_____
SHFt	SHIFT/OFFSET	0	_____
SPLO	SETPOINT LOW LIMIT	0	_____
SPHI	SETPOINT HIGH LIMIT	9999	_____
INPt	USER INPUT FUNCTION	PLDC	_____
F1In	F1 KEY FUNCTION	NONE	_____

ALARM MODULE (4-AL)

DISPLAY	PARAMETER	FACTORY SETTING	USER SETTING
ALt1	ALARM 1 ACTION	Auto	_____
ALt1	ALARM 1 ANNUNCIATOR	nor	_____
rSt1	ALARM 1 RESET MODE	Auto	_____
Stb1	ALARM 1 STANDBY	NO	_____
AL-1	ALARM 1 VALUE	0	_____
ALt2	ALARM 2 ACTION	Auto	_____
ALt2	ALARM 2 ANNUNCIATOR	nor	_____
rSt2	ALARM 2 RESET MODE	Auto	_____
Stb2	ALARM 2 STANDBY	NO	_____
AL-2	ALARM 2 VALUE	0	_____
ALHYS	ALARM 1 & 2 HYSTERESIS	1 T16 0.1 P16	_____

INPUT MODULE (1-IN) P16 ONLY

DISPLAY	PARAMETER	FACTORY SETTING	USER SETTING
tYPE	INPUT TYPE	curr	_____
PCt	PERCENT ANNUNCIATOR	NO	_____
dCPt	DECIMAL RESOLUTION	00	_____
rnd	ROUNDING INCREMENT	0.1	_____
FLtr	DIGITAL FILTERING	1	_____
dSP1	DISPLAY VALUE SCALING 1	00	_____
INP1	INPUT VALUE SCALING 1	400	_____
dSP2	DISPLAY VALUE SCALING 2	1000	_____
INP2	INPUT VALUE SCALING 2	2000	_____
SPLO	SETPOINT LOW LIMIT	00	_____
SPHI	SETPOINT HIGH LIMIT	9999	_____
INPt	USER INPUT FUNCTION	PLDC	_____
F1In	F1 KEY FUNCTION	NONE	_____

COOLING MODULE (5-02)

DISPLAY	PARAMETER	FACTORY SETTING	USER SETTING
CYCL	CYCLE TIME	20	_____
GRN	RELATIVE GAIN	10	_____
db-2	DEADBAND	0	_____

T16 & P16 PROGRAMMING QUICK OVERVIEW

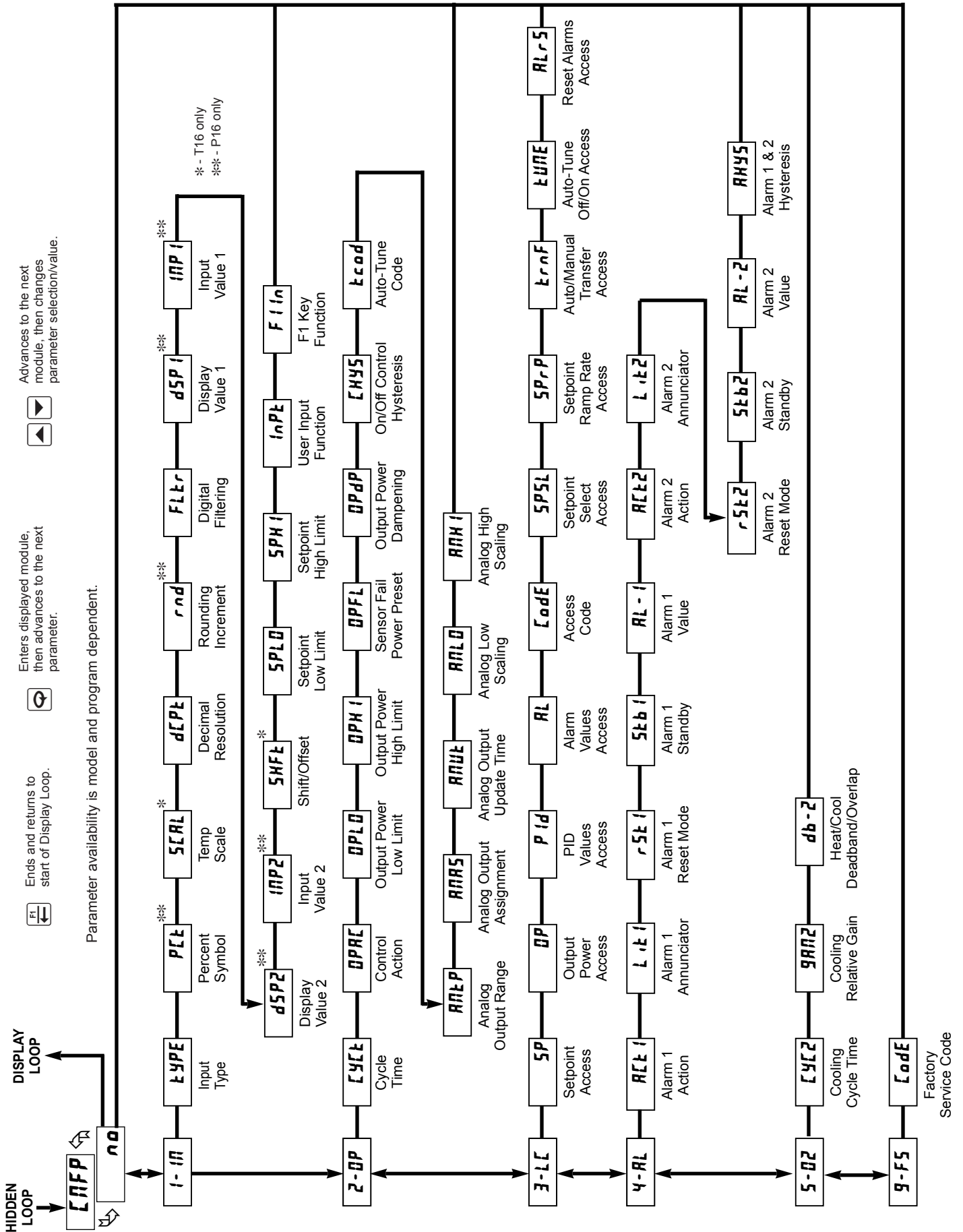

This page intentionally left blank

This page intentionally left blank

LIMITED WARRANTY

The Company warrants the products it manufactures against defects in materials and workmanship for a period limited to two years from the date of shipment, provided the products have been stored, handled, installed, and used under proper conditions. The Company's liability under this limited warranty shall extend only to the repair or replacement of a defective product, at The Company's option. The Company disclaims all liability for any affirmation, promise or representation with respect to the products.

The customer agrees to hold Red Lion Controls harmless from, defend, and indemnify RLC against damages, claims, and expenses arising out of subsequent sales of RLC products or products containing components manufactured by RLC and based upon personal injuries, deaths, property damage, lost profits, and other matters which Buyer, its employees, or sub-contractors are or may be to any extent liable, including without limitation penalties imposed by the Consumer Product Safety Act (P.L. 92-573) and liability imposed upon any person pursuant to the Magnuson-Moss Warranty Act (P.L. 93-637), as now in effect or as amended hereafter.

No warranties expressed or implied are created with respect to The Company's products except those expressly contained herein. The Customer acknowledges the disclaimers and limitations contained herein and relies on no other warranties or affirmations.

Red Lion Controls
20 Willow Springs Circle
York PA 17406
Tel +1 (717) 767-6511
Fax +1 (717) 764-0839

Red Lion Controls BV
Printerweg 10
NL - 3821 AD Amersfoort
Tel +31 (0) 334 723 225
Fax +31 (0) 334 893 793

Red Lion Controls AP
31, Kaki Bukit Road 3,
#06-04/05 TechLink
Singapore 417818
Tel +65 6744-6613
Fax +65 6743-3360