

MODEL APLPV - APOLLO PROCESS VOLTMETER

- 3 1/2 DIGIT, 0.56" (14.2 mm) LED READOUT
- SEALED METAL FRONT BEZEL (NEMA 4/IP65)
- 12 VDC EXCITATION SUPPLY (Optional)
- WIDE RANGE SPAN & OFFSET SCALING (Covers 1 to 5 VDC Process Input)
- FRONT ACCESS TO CALIBRATION TRIM CONTROLS
- OVERRANGE INDICATION
- PLUG-IN TERMINAL STRIPS
- SELECTABLE DECIMAL POINTS
- ±25 VOLT DC MAXIMUM INPUT



DESCRIPTION

The premium features of the Apollo series can now be applied to measurement of process variables. With its high sensitivity and programmability, the Apollo Process Voltmeter can be set up for a wide variety of applications.

The rugged construction and sealed metal front bezel meet the requirements of NEMA 4/IP65, when properly installed. This allows the APLPV to be used in dirty, hostile environments and in wash-down areas. In addition, the attractive die-cast metal bezel enhances the appearance of any control panel.

SPECIFICATIONS

1. **DISPLAY:** 3 1/2 digit (1999), 0.56" (14.2 mm) L.E.D., minus sign displayed for negative values. Decimal points inserted before 1st, 2nd, or 3rd least significant digits by DIP programming switches.
2. **POWER:** Available for 115 or 230 VAC ±10%, 50/60 Hz., 6 VA.
3. **INPUT SENSITIVITY:** (Numerical Readout Change/Volt) Adjustable from 40 units/volt to 1000 units/volt. Max. allowable input voltage, ±25 volts DC.
4. **INPUT RESISTANCE:** 1 MΩ
5. **SCALING RANGE:**
 - Span** - 32 coarse steps (binary progression with 5 DIP switches, rear access). Each step providing approximately 40 numerical units/volt/step sensitivity. Fine adjust (front access) brackets the coarse step increments.
 - Offset** - 16 coarse steps (binary progression with 4 DIP switches, rear access) with ± switch to add or subtract offset. Each step adds or subtracts approximately 175 from the numerical display for a total offset range of ±2700. Front access fine control brackets the steps.

6. **LINEARITY:** ±(0.05% ± 1 digit)
7. **READING RATE:** 2 1/2 updated readings/second, nominal.
8. **RESPONSE TIME:** 1 second to settle for step change.
9. **NORMAL MODE REJECTION:** 63 dB, 50/60 Hz.
10. **COMMON MODE REJECTION:** 100 dB, DC to 50/60 Hz.
11. **TEMPERATURE EFFECTS:**
 - Operating Range** - 0° to +60° C
 - Storage Range** - -40° to +80° C
 - Span Temperature Coeff.** - 100 ppm/°C
 - Offset Temperature Coeff.** - 100 ppm/°C
12. **EXCITATION SUPPLY (Optional):** 12 VDC @ 60 mA max. Regulated and isolated (floating). (See Ordering Information).
13. **CONSTRUCTION:** Die cast metal front bezel with black, high impact plastic insert. Front panel meets NEMA 4/IP65 requirements for wash-down and dusty environments when properly installed. (Panel gasket and mounting clips included.)
14. **CONNECTIONS:** Plug-in, compression type barrier terminal strip.
15. **WEIGHT:** 1.2 lb (0.54 Kg)

DIMENSIONS In inches (mm)

Note: Recommended minimum clearance (behind the panel) for mounting clip installation is 2.1" (53.4) H x 5.5" (140) W.

PANEL CUT-OUT

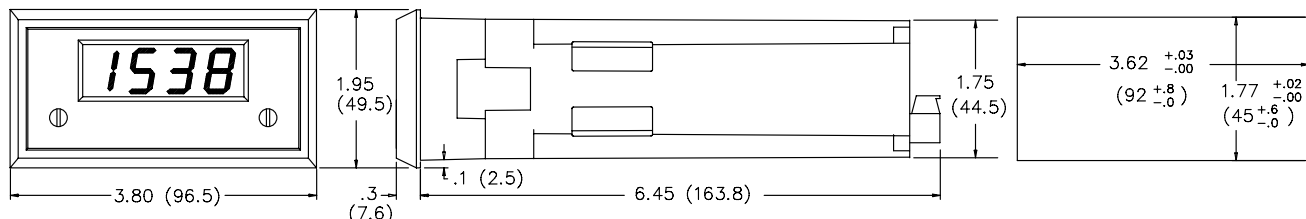

SIMPLIFIED SCHEMATIC, APOLLO PROCESS VOLTMETER

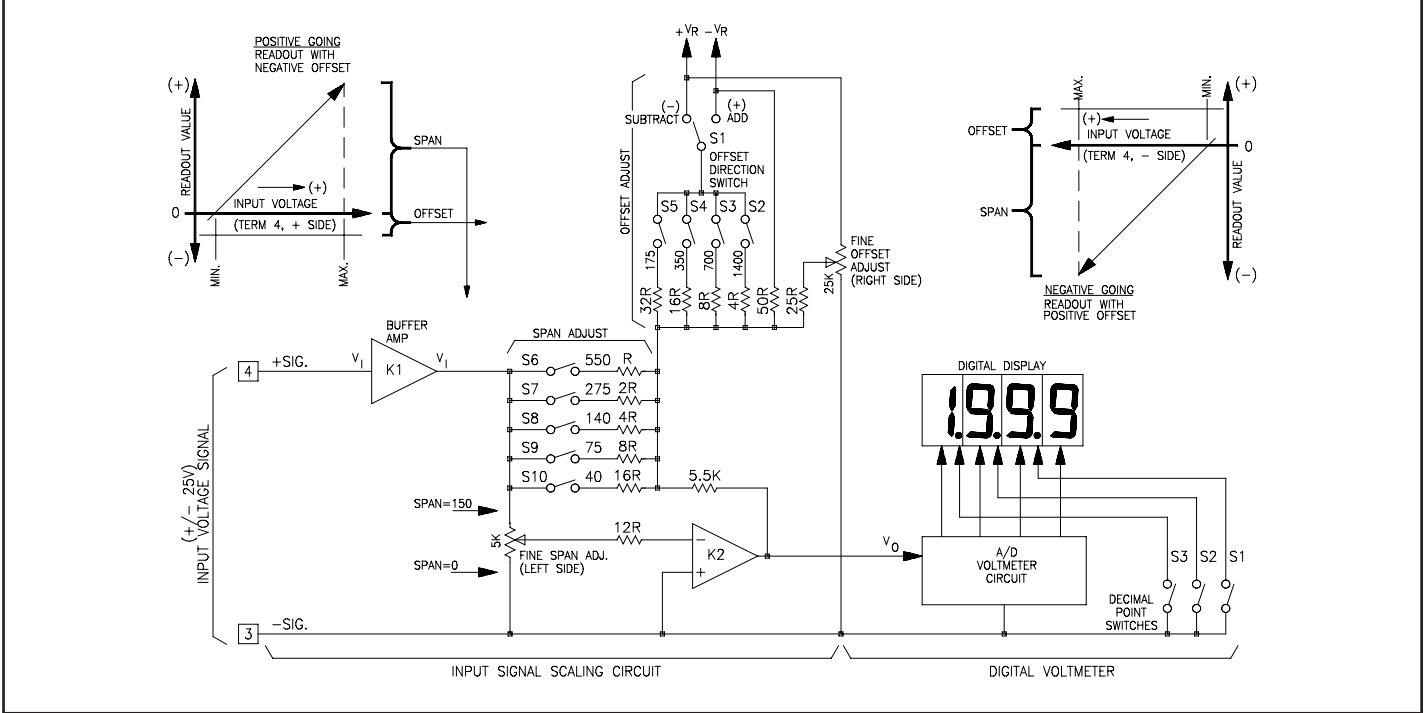

DESCRIPTION OF OPERATION

The Apollo Process Voltmeter (APLPV) consists of a digital voltmeter combined with an analog scaling circuit (shown above). The input voltage can be reversed in polarity resulting in negative numerical readout with a minus (-) sign displayed.

Input terminals 3 and 4 are connected to the signal voltage. The buffer amplifier (K1) conditions and filters the input signal voltage and applies it to the input of the scaling circuit.

The procedure for scaling Apollo Process Voltmeters is simplified by dividing the scaling process into two separate components, span adjustments and offset adjustments which are defined in the following discussion.

SPAN ADJUSTMENTS

Span is defined as the numerical range that the display traverses, disregarding decimal points, when the input signal voltage is varied from minimum to maximum.

For example, if a unit is to display 25.0 @ 1 V and 100.0 @ 5 V, the span is 750 (the difference between 250 and 1000). Had the minimum display been -25.0 @ 1 V and +100.0 @ 5 V, the span would be 1250 or 1000 - (-250) = 1250. (Note: the terms "GAIN", "SCALE", and "SENSITIVITY" are also frequently used interchangeably with the term "SPAN".)

The Apollo Process Voltmeter can be set up over a very wide span range by means of the coarse DIP switches S6-S10 (on the rear), and the fine screwdriver adjustment pot, located behind the sealing screw on the front bezel (left side). The coarse span switches add parallel input resistors to the summing amplifier (K2), thereby increasing its gain, or sensitivity, as more summing resistors are added.

Effectively, adding more parallel input resistors, increases the slope of the transfer curve (at right) and increases the numerical readout for a given input signal voltage change. The input summing resistor values are weighted in a binary progression, so they can be switched in combinations to give 32 discrete steps of span. The front panel fine adjust control brackets these coarse steps and can be adjusted to the exact span needed.

The approximate span contributed by each switch is shown on the rear label. The values shown are "units per volt". For example, if S6 only is turned "ON", the numerical readout will change approximately 550 units for a + signal voltage change of 1 volt. If S7 were also turned "ON", the numerical readout would change approximately 825 units for a signal voltage change of 1 volt. The fine control has a continuous span range of approximately 0-45.

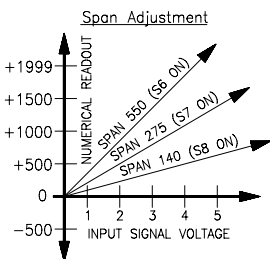

OFFSET ADJUSTMENTS

In the foregoing discussion of span, the transfer curves were shown as "ZERO-BASED", i.e., the numerical readout displays "0" when the signal voltage goes to zero. With voltage ranges such as 0-5 V or 0-10 V, and with Bi-Polar (+/-) signals this is often the desired condition. However, with voltage ranges such as 1-5 V or 1-10 V, the minimum voltage level usually represents the zero level of the parameter being displayed. There are also many applications where the minimum (or zero level) represents some value that does not fall on a zero based transfer curve.

To accommodate non-zero based applications, the Apollo Process Voltmeter has provisions for offsetting the transfer curve over a wide range. Essentially, offset moves the transfer curve up or down to change its intercept with the numerical readout axis, but it does not change the slope (SPAN) of the transfer curve.

In the Apollo Process Voltmeter, offset is accomplished by adding (or subtracting) a constant at the input of the summing amplifier (K2). This offset constant is summed in with a switched binary resistor network and a fine adjust offset control in a similar manner to that used for span adjust. Switches S2-S5 (at the rear) can be turned on in combinations to give 16 different coarse offset levels.

Each switch is labeled to show the approximate amount of offset contributed when it is turned "ON". Switch 1 selects the polarity of the switched-in offset value and allows offsetting the transfer curve "UP" (adding the offset constant) or "DOWN" (subtracting). The fine control (front panel, right) has a numerical readout range of +/-100 and brackets all the coarse switched ranges.

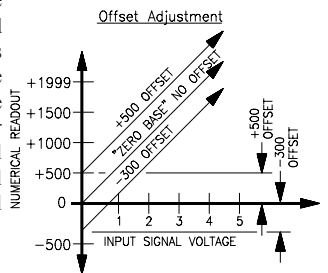

CALIBRATION

Direct calibration using the process signal voltage is usually not practical due to the difficulty in varying the measured parameter and the confusing interaction that occurs between span and offset adjustments. However, the APLPV can be quickly and easily bench calibrated using a commercially available voltage source.

CALIBRATION PROCEDURE

The procedure outlined on the following page minimizes span/offset interaction and simplifies calibration. In Steps 1 and 2 the unit is “nulled” to zero readout with zero input signal voltage. In Steps 3, 4, and 5, the span adjustments are made to establish the required slope of the transfer curve.

Then in Step 6, the transfer curve is shifted up or down as required by setting the offset adjustments. In Step 7, the final “tweaking” adjustments are made at minimum and maximum signal voltage. Setting the decimal points in Step 8 completes the calibration.

Before calibrating, the READOUT SPAN (R_s), SWING VOLTAGE (V_s), and SPAN PER VOLT (R_s/V_s) must be determined.

$$R_s = (\text{Max. Numerical Display}) - (\text{Min. Numerical Display})$$

(Disregard Decimal Points)

$$V_s = (\text{Voltage @ Max. Display}) - (\text{Voltage @ Min. Display})$$

$$R_s/V_s = \text{READOUT SPAN } (R_s) / \text{SWING VOLTAGE } (V_s)$$

Example: Readout is to be 5.00 @ 1 V and 15.00 @ 5 V.

$$\text{READOUT SPAN } (R_s) = 1500 - 500 = 1000$$

$$\text{SWING VOLTAGE } (V_s) = 5 \text{ V} - 1 \text{ V} = 4 \text{ V}$$

$$\text{SPAN PER VOLT } (R_s/V_s) = 1000 / 4 \text{ V} = 250$$

ADJUSTMENTS

- | | | |
|-------------|---|---|
| ZERO | } | 1. Turn off all coarse offset and span adjustment switches (S2-S10 down). S1 has no effect when zeroing and can be in either position. |
| | | 2. Apply zero volts to the signal input. Adjust the indicator to read zero using the fine offset adjustment (R.H. side, front panel). |
| SPAN | } | 3. Select a combination of coarse span switches (S6-S10) to obtain a value closest to SPAN PER VOLT (the coarse span switch reference markings correspond numerically with SPAN PER VOLT). From example:
SPAN PER VOLT = 250
S8 (140) + S9 (75) + S10 (40) = 255 span set with switches |
| | | 4. With the SWING VOLTAGE, V_s , applied to the input, adjust the display readout to the exact READOUT SPAN (1000 in the example) with the fine span adj. (front, left). |
| | | 5. Repeat Step 2 to see if the zero value has shifted. If it has, re-zero with fine offset (front, right), then repeat Step 4. |
| OFFSET | } | 6. After the span has been adjusted, set the signal voltage to the minimum level (1 V in example). Then set the offset add/subtract switch (S1), the coarse offset switches (S2-S5) and the fine offset control (front, right) to obtain the readout corresponding to this minimum voltage value (500 in the example). |
| MAX/MIN CHK | | 7. Adjust the input signal voltage to its maximum value to see if the proper readout is obtained (1500 @ 5 V in the example). If the readout is slightly off, adjust the fine span (front, left) to obtain the true reading. Then, recheck the reading at minimum input voltage (1 V) and readjust fine offset (front, right) if necessary. Repeat the maximum and minimum readout adjustments until the unit displays the proper readout at both extremes. |
| | | 8. Set decimal points as desired using the three switches on the side of the case and replace the front panel sealing screws. The unit can now be installed. |

APPLICATION EXAMPLES

Example 1 (\pm Display): A differential pressure transducer has a range of ± 15 PSI with a 1-6 V output (-15 @ 1 V, +15 @ 6 V)

$$\text{READOUT SPAN } (R_s) = +1500 - (-1500) = 3000$$

$$\text{SWING VOLTAGE } (V_s) = 6 \text{ V (max)} - 1 \text{ V (min)} = 5 \text{ V}$$

$$\text{SPAN PER VOLT } (R_s/V_s) = 3000 / 5 \text{ V} = 600$$

Note: Since the display readout is limited to 1999 numerical indication, the full READOUT SPAN of 3000 cannot be obtained during zero based span adjustment. However, dividing both the READOUT SPAN and SWING VOLTAGE by two, i.e. 1500 readout @ 2.5 V, allows the span adjustment to be made for the proper transfer curve slope.

ADJUSTMENTS

- Null the unit to zero readout @ 0 V per Steps 1 and 2 of the calibration procedure.
- Set transfer curve slope with span adjustments per Steps 3, 4, and 5 to get a readout of +1500 @ 2.5 V (SPAN PER VOLT = 600).
- Apply (-) offset per Step 6 to get a reading of -1500 @ 1 V.
- Check min. and max. extremes and tweak if required to get desired readout @ 1 V and 6 V per step 7. Set D.P. switch S2 and replace front panel sealing screws.

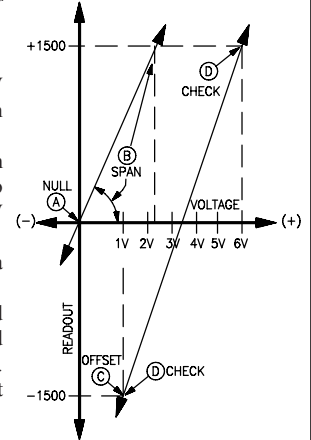

Example 2 (Positive Offset): An APLPV is to be calibrated to match a flow transducer whose output is 0 V @ 40 GPM and 5 V @ 650 GPM.

$$\text{READOUT SPAN } (R_s) = 650 - 40 = 610$$

$$\text{SWING VOLTAGE } (V_s) = 5 \text{ V (max)} - 0 \text{ V (min)} = 5 \text{ V}$$

$$\text{SPAN PER VOLT } (R_s/V_s) = 610 / 5 \text{ V} = 122$$

ADJUSTMENTS

- Null the unit per Steps 1 and 2 of the calibration procedure.
- Set the coarse and fine span adjustments to get a readout of 610 @ 5 V (SPAN PER VOLT = 122) per Steps 3, 4, and 5.
- Set offset to readout 40 @ 0 V per Step 6.
- Check the readout @ max. (5 V) and min. (0 V) and fine tune (tweak) as required per Step 7.

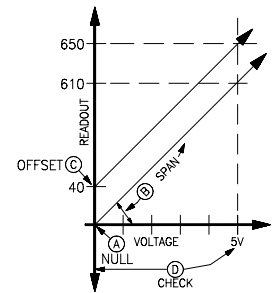

Example 3 (Negative Slope): A liquid level sensor puts out 1 V when a storage tank is full and 11 V when the tank is empty. The APLPV is to readout 100.0 when the tank is full and zero when the tank is empty.

$$\text{READOUT SPAN } (R_s) = 1000 - 0 = 1000$$

$$\text{SWING VOLTAGE } (V_s) = 1 \text{ V (max)} - 11 \text{ V (min)} = -10 \text{ V}$$

$$\text{SPAN PER VOLT } (R_s/V_s) = 1000 / -10 \text{ V} = -100$$

In this case, the signal voltage is reversed [Term. 3 (+) with respect to Term. 4 (-)] causing the readout to go “down” (increasingly negative) as the negative voltage increases (hence, the negative (-) SPAN PER VOLT).

ADJUSTMENTS

- Null the unit per Steps 1 and 2 of the calibration procedure.
- Set the slope of the transfer curve with the span adjustments to get a readout of -1000 @ -10V (SPAN PER VOLT = -100) per Steps 3, 4, and 5.
- Move the transfer curve up by applying (+) offset per Step 6 until readout is +1000 @ -1 V.
- Check extreme readings per Step 7, 0 readout @ -11 V and +1000 @ -1 V. Set D.P. switch S1 and replace front panel sealing screws.

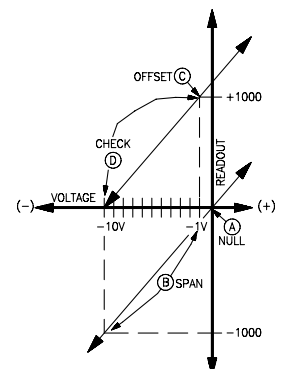

INSTALLATION

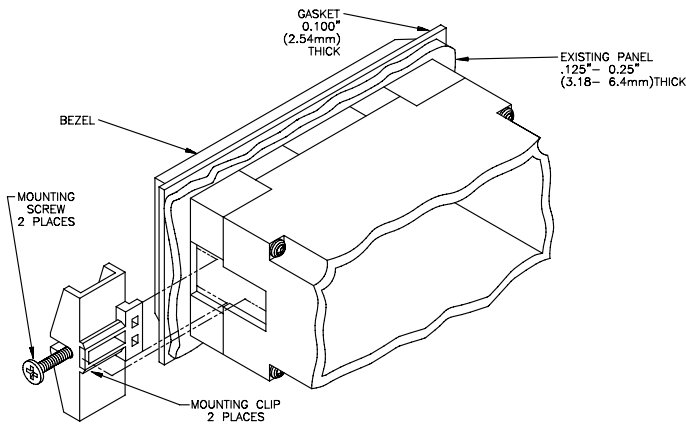

The Apollo Process Voltmeter is designed to be panel-mounted with a gasket to provide a water-tight seal. Two mounting clips and screws are provided for easy installation. Consideration should be given to the thickness of the panel. A panel which is too thin may distort and not provide a water-tight seal. (Recommended minimum panel thickness is 1/8".)

After the panel cut-out has been completed and deburred, carefully slide the gasket over the rear of the unit to the back of the bezel. Insert the unit into the panel. As depicted in the drawing, install the screws into the narrow end of the mounting clips. Thread the screws into the clips until the pointed end just protrudes through the other side.

Install each of the mounting clips by inserting the wide lip of the clips into the wide end of the hole, located on either side of the case. Then snap the clip onto the case. Tighten the screws evenly to apply uniform compression, thus providing a water-tight seal.

Caution: Only minimum pressure is required to seal panel. Do **NOT** overtighten screws.

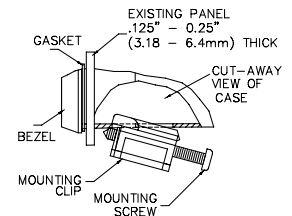

FLOW RATE INDICATION APPLICATION

A milk producer wants to know the rate, in Gallons Per Minute (GPM), at which their milk tanks are being filled. A flowmeter, with an analog output voltage of 1 V at 0 GPM and 6 V at 170 GPM, is installed at the tank inlet.

The Model APLPV can be easily calibrated to readout 00.0 at 0 GPM and 170.0 at 170 GPM:

$$\begin{aligned} \text{READOUT SPAN (Rs)} &= 1700 - 000 = 1700 \\ \text{SWING VOLTAGE (Vs)} &= 6 \text{ V} - 1 \text{ V} = 5 \text{ V} \\ \text{SPAN PER VOLT (Rs/Vs)} &= 1700/5 \text{ V} = 340 \end{aligned}$$

ZERO THE UNIT:

1. Turn off all of the coarse offset and span switches.
2. Apply zero volts to the signal input. Adjust the indicator to read zero using the fine offset adjustment (R.H. side, front panel).

SET THE SPAN:

3. Select the combination of coarse span switches to obtain a value just below 340 (SPAN PER VOLT):
 $S7 (275) + S10 (40) = 315$ span set with switches.
4. With S7 & S10 "ON", and 5 V (SWING VOLTAGE) applied to the input, adjust the display readout to 1700 (READOUT SPAN) with the fine span adjust (front, left).
5. Repeat Step 2 to see if the zero value has shifted. If it has, re-zero with the fine offset adjust (front, right), then repeat Step 4.

ADD IN THE OFFSET:

6. After the span has been adjusted, set the signal voltage to 1 V (the minimum level). Since the desired readout is 000 at 1 V, and the current readout is 340 at 1 V, it can be seen that an offset of -340 is required. Turn "ON" S1 to achieve the negative offset, and select the combination of coarse offset switches to obtain the value nearest to 340:
 $S4 (350) = 350$ offset set with switches.
- With S1 & S4 "ON", the fine offset control (front, right), can be adjusted to obtain a readout of 000 @ 1 V.

CHECK MAXIMUM AND MINIMUM SETTINGS:

7. Adjust the input signal voltage to 6 V (the maximum level), the readout should be 1700. If the readout is slightly off, adjust the fine span (front, left) to obtain the true reading. Then, adjust the signal input voltage to 1 V (the minimum level), the readout should be 000. If the readout is slightly off, adjust the fine offset (front, right). Repeat the maximum and minimum readout adjustments until the unit displays the proper readout at both extremes.

FINAL SET-UP:

8. The resolution of the display is 0.1 GPM, therefore "D.P.1" is selected. After replacing the front panel sealing screws, the unit is ready to be installed.

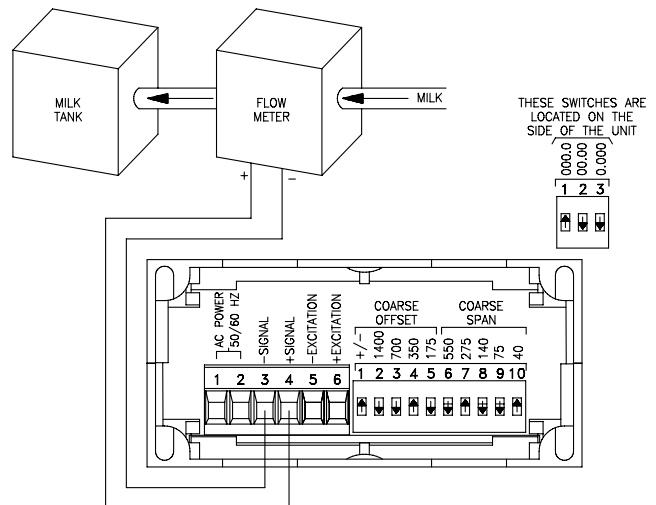

ORDERING INFORMATION

MODEL NO.	DESCRIPTION	PART NUMBERS FOR AVAILABLE SUPPLY VOLTAGES	
		230 VAC	115 VAC
**APLPV	Apollo Process Voltmeter w/o Excitation	APLPV410	APLPV400
	Apollo Process Voltmeter w/12 VDC Excitation Supply	APLPV411	APLPV401

For information on Pricing, Enclosures, & Panel Mount Kits refer to the RLC Catalog or contact your local RLC distributor.

** - Units are shipped calibrated to read 00.0 @ 1.0 VDC, 100.0 @ 5.0 VDC.