



Tel +1 (717) 767-6511  
 Fax +1 (717) 764-0839  
 www.redlion-controls.com

Bulletin No. C48C-B  
 Drawing No. LP0350  
 Revised 3/01

## C48C SERIES - 1/16 DIN COUNTERS

**MODEL C48CS - SINGLE PRESET**

**MODEL C48CD - DUAL PRESET**

**MODEL C48CB - THREE PRESET BATCH**

- LCD, 7 SEGMENT, 2 LINE, 6 DIGIT DISPLAY, POSITIVE REFLECTIVE OR NEGATIVE TRANSMISSIVE MODELS WITH RED TOP LINE AND GREEN BOTTOM LINE BACKLIGHTING
- QUADRATURE SENSING ( Up to 4 times resolution)
- BI-DIRECTIONAL COUNTING, UP/DOWN CONTROL
- FIELD REPLACEABLE RELAY OUTPUT BOARDS
- STATUS INDICATORS FOR OUTPUTS
- NEMA 4X/IP65 SEALED BEZEL
- PARAMETER SECURITY VIA PROGRAMMABLE OPERATOR ACCESS PRIVILEGES AND PROTECTED VALUE MENU
- PROGRAMMABLE USER INPUTS AND FRONT PANEL FUNCTION KEY



- HORIZONTAL OR VERTICAL STACKING OF MULTIPLE UNITS
- 85 to 250 VAC OR 18 to 36 VDC/24 VAC POWERED UNITS
- RS485 SERIAL COMMUNICATIONS OPTION
- CHOICE OF NUMERIC DATA ENTRY MODES



UL Recognized Component,  
 File # E137808

### DESCRIPTION

The Model C48 Counter is available as a Standard Counter or a Batch Counter. The Standard Counter is available with single or dual presets. The Batch Counter has a main process counter with dual presets and a secondary counter with a single preset. The secondary counter can be selected to function as a batch or a total counter.

The C48C features a 7 segment, 2 line by 6 digit reflective or backlit LCD display. For the backlit versions, the main display line is red and shows the count value or the Batch/Total value when preset 3 or output 3 is viewed in the secondary display. The smaller secondary display line is green and can be used to view the prescaler value, preset values, output time values or Batch/Total count values (Batch model).

The C48C offers a choice of nine programmable counting modes for use in applications requiring bi-directional, anti-coincidence, and quadrature counting. The unit may be programmed to register counts on both edges of the input signal providing frequency doubling capability. DIP switches are used for input configuration set-up and to provide a Program Disable function.

Four front panel push-buttons are used for programming the operating modes and data values, changing the viewed display, and performing user programmable functions, e.g. reset, etc. The C48C can be configured for one of two numeric data entry methods, digit entry or automatic scrolling. The digit entry method allows for the selection and incrementing of digits individually. The automatic scrolling method allows for the progressive change of one through all digit positions by pressing and holding the "up" or "down" button.

The Program Disable DIP switch, a user-programmable code value, and an external user input selected for Program Disable can be utilized to provide multi-level protection against unauthorized changes to data values and unit configuration.

The C48 Counter has programmable User Inputs and a programmable front panel function key. The user inputs can be configured as sinking (active low) or sourcing (active high) inputs via a single plug jumper. The user inputs and the front panel function key can be configured to provide a variety of functions.

The Standard Counter with Dual Presets is available with solid-state or Relay outputs. The Single Preset model has a solid-state and relay output. The Batch Counter has relay outputs for Output 2 and the Batch/Total Output 3, with Output 1 available as solid-state. The Batch Counter is also available with three solid-state outputs. For all C48 Counters, the solid-state outputs are available in a choice of NPN current sinking or PNP current sourcing, open-collector transistor outputs. All relay output boards are field replaceable.

A Prescaler Output model is available as a Dual Preset, with solid-state outputs. The Prescaler Output is useful for providing a lower frequency scaled pulse train to a PLC or another external totalizing counter. The Prescaler Output provides a programmable width output pulse for every count or every 10 counts registered on the display.

The optional RS-485 serial communication interface provides two-way communication between a C48 and other compatible equipment such as a printer, PLC, HMI, or a host computer. In multipoint applications (up to thirty-two), the address number of each C48 on the line can be programmed from 0 to 99. Data from the C48 can be interrogated or changed, and alarm output(s) may be reset by sending the proper command code via serial communications. PC software, SFC48, allows for easy configuration of controller parameters. These settings can be saved to disk for later use or used for multi-controller down loading. On-line help is provided within the software.

Optional programming software (SFC48) is available to program all unit configuration parameters. The software allows unit configurations to be created, uploaded, downloaded, and saved to a file for later use or multi-unit programming.

The unit is constructed of a lightweight, high impact plastic case with a textured front panel and a clear display window. The front panel meets NEMA 4X/IP65 specifications when properly installed. Multiple units can be stacked horizontally or vertically. Modern surface-mount technology, extensive testing, plus high immunity to noise interference makes the C48 Counters extremely reliable in industrial environments.

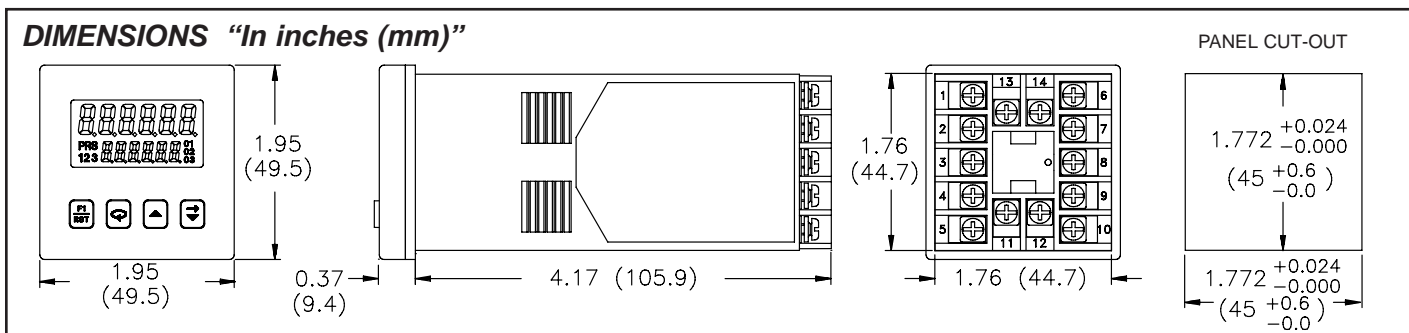

## SPECIFICATIONS

1. **DISPLAY:** 2 Line by 6 digit LCD display. Positive image reflective or negative image transmissive with red (top line) and green (bottom line) backlighting

**Main Display:** 0.3" (7.62 mm) high digits

**Secondary Display:** 0.2" (5.08 mm) high digits

**Annunciators:**

**Value:** PRS, 1, 2, and 3

**Output:** 01, 02, and 03.

2. **POWER REQUIREMENTS:**

**AC Versions:**

**AC Power:** 85 to 250 VAC, 50/60 Hz, 9 VA max.

**DC Power:** 11 to 14 VDC @ 150 mA max. (Non PNP output models)

*Note: Models with PNP current sourcing outputs must be powered from AC.*

**DC Versions (C48XXX1X):**

**CONTINUOUS:**

**DC Power:** 18 to 36 VDC; 5.5 W max.

**AC Power:** 24 VAC  $\pm 10\%$ ; 50/60 Hz; 7 VA max.

*Note: The +10% tolerance range on AC input voltage must be strictly adhered to. DO NOT EXCEED 26.4 VAC.*

**PEAK (START-UP CURRENT):**

**AC or DC Power:** 500 mA peak start-up current for 10 msec max.

**DC OUT ( $V_{SRC IN}$ ) - Terminal 10**

For units which do not have PNP current sourcing outputs, this terminal provides a DC output for sensor power (+12 VDC  $\pm 15\%$ ). The maximum sensor current is 100 mA.

For units with PNP current sourcing outputs, this terminal serves a dual purpose depending on the application's PNP output voltage level and current requirements.

1. The terminal may be used as a +12 VDC output for sensor power. In this case, the PNP output voltage level will be +12 VDC ( $\pm 15\%$ ). A maximum of 100 mA is available for the combination of sensor current and PNP output sourcing current.

2. If a higher PNP output voltage level or additional output sourcing current is desired, an external DC supply may be connected between the "DC OUT ( $V_{SRC IN}$ )" and "COMM." terminals. This supply will determine the PNP output voltage level, and must be in the range of +13 to +30 VDC.

An external DC supply can also provide the additional output sourcing current required in applications where two or more PNP outputs are "ON" simultaneously. However, the maximum current rating of 100 mA per individual output must not be exceeded, regardless of external supply capacity.

3. **MEMORY:** Nonvolatile E<sup>2</sup>PROM retains all programmable parameters and count values.

4. **SENSOR POWER:** +12 VDC ( $\pm 15\%$ ) @ 100 mA max.

5. **COUNT INPUTS A & B:** Accepts count pulses from a variety of sources, DIP switch selectable.

**Current Sourcing:** 3.9K $\Omega$  pull-down,  $V_{IN}$  max = 30 VDC

**Current Sinking:** 7.8K $\Omega$  pull-up to 12 VDC;  $I_{SNK}$  = 1.8 mA max.

**Debounce:** 50 Hz max.

**Lo Bias:**  $V_{IL}$  = 1.5 VDC max.,  $V_{IH}$  = 3.75 VDC min.

**Hi Bias:**  $V_{IL}$  = 5.5 VDC max.,  $V_{IH}$  = 7.5 VDC min.

6. **MAX. COUNT RATE:** Model dependent. All listed values are in KHz.

*Note: Max. count rates for X2 & X4 modes are given for 50 % duty cycle signals and quad signals with 90° phase shift.*

**Single Preset Model C48CS**

PRESCALER VALUE	C1-Usr C1-Ud	C2-Usr C2-Ud	*Ad-Sub Ad-Ad	QUAD		
				X1	X2	X4
0.00001-0.99999	8.4	4.1	9.4	5.4	4.5	2.1
1.00000	12	5.9	12.4	6.5	6	3
1.00001-2	6.6	3.2	6.8	4.3	3.3	1.6
2.00001-3	5.3	2.6	5.6	3.7	2.6	1.3
3.00001-4	4.3	2.1	4.6	3	2.2	1.1
4.00001-5	3.6	1.8	3.8	2.7	1.8	0.9
5.00001-6	3.1	1.5	3.4	2.4	1.6	0.8
6.00001-7	2.8	1.4	3.2	2.1	1.4	0.7
7.00001-8	2.6	1.3	2.8	1.9	1.3	0.6
8.00001-9	2.3	1.1	2.4	1.8	1.1	0.5
9.00001-9.99999	2.1	1	2.3	1.7	1.1	0.5

**Dual Preset Model C48CD**

PRESCALER VALUE	C1-Usr C1-Ud	C2-Usr C2-Ud	*Ad-Sub Ad-Ad	QUAD		
				X1	X2	X4
0.00001-0.99999	8.3	4.1	8.6	4.5	4.1	2.1
1.00000	11.5	5.7	11.5	6	5.8	3
1.00001-2	6.5	3.2	6.6	4	3.2	1.6
2.00001-3	5	2.4	5.2	3.4	2.5	1.3
3.00001-4	4.1	2	4.4	2.8	2	1
4.00001-5	3.4	1.7	3.8	2.5	1.7	0.8
5.00001-6	2.9	1.4	3.2	2.2	1.4	0.7
6.00001-7	2.7	1.3	2.8	2	1.3	0.6
7.00001-8	2.2	1.1	2.4	1.8	1.2	0.6
8.00001-9	2.2	0.9	2.3	1.6	1.1	0.5
9.00001-9.99999	1.9	0.9	2	1.5	0.9	0.4

**Batch Model C48CB**

With Counter 2 configured as a Batch Counter ( $\Sigma 2 \#5n = bRtCh$ )

PRESCALER VALUE	C1-Usr C1-Ud	C2-Usr C2-Ud	*Ad-Sub Ad-Ad	QUAD		
				X1	X2	X4
0.00001-0.99999	8.3	4.1	8.4	3.7	3.6	2.2
1.00000	11.4	5.5	11.8	4.3	4.2	3
1.00001-2	6.5	3.2	6.6	3.2	3	1.6
2.00001-3	5	2.5	5.4	2.8	2.5	1.3
3.00001-4	4.1	2	4.2	2.4	2	1
4.00001-5	3.4	1.7	3.8	2.1	1.7	0.8
5.00001-6	2.9	1.4	3.2	1.9	1.5	0.7
6.00001-7	2.7	1.3	2.8	1.7	1.3	0.6
7.00001-8	2.4	1.1	2.6	1.6	1.2	0.6
8.00001-9	2.2	1.1	2.4	1.5	1.1	0.5
9.00001-9.99999	1.9	0.9	2.2	1.4	1	0.4

**Batch Model C48CB**

With Counter 2 configured as a Total Counter ( $\Sigma 2 \#5n = tAtRL$ )

PRESCALER VALUE	C1-Usr C1-Ud	C2-Usr C2-Ud	*Ad-Sub Ad-Ad	QUAD		
				X1	X2	X4
0.00001-0.99999	6.5	3.3	6.6	3.5	3.3	1.6
1.00000	8.5	3.6	8.6	4	4	2.1

**Prescaler Output Model C48CP**

PRESCALER VALUE	C1-Usr C1-Ud	C2-Usr C2-Ud	*Ad-Sub Ad-Ad	QUAD		
				X1	X2	X4
0.00001-0.99999	6.2	N/A	N/A	N/A	N/A	N/A
1.00000	8	N/A	N/A	N/A	N/A	N/A

\* - Inputs A & B rates summed.

7. **USER INPUTS:** Configurable as current sinking (active low) or current sourcing (active high) inputs via a single plug jumper.

**Current Sinking:**  $V_{IL}$  = 1.5 VDC max, 22 K $\Omega$  pull-up to 5 VDC.

**Current Sourcing:**  $V_{IH}$  = 3.5 VDC min.,  $V_{IN}$  max = 30 VDC; 22 K $\Omega$  pull-down.

**Response Time** = 10 msec max.

**Inhibit Response Time** = 250  $\mu$ sec max.

8. **OUTPUTS:** (Output type and quantity, model dependent)

**Solid-State:**

**NPN Open Collector:**  $I_{SNK}$  = 100 mA max. @  $V_{OL}$  = 1.1 VDC max.;  $V_{OH}$  = 30 VDC max.

**PNP Open Collector:**  $I_{SRC}$  = 100 mA max. (See note);  $V_{OH}$  = 12 VDC  $\pm 15\%$  (using internal supply);  $V_{OH}$  = 13 to 30 VDC (using external supply).

*Note: The internal supply of the C48C can provide a total of 100 mA for the combination of sensor current and PNP output sourcing current. The supply voltage is +12 VDC ( $\pm 15\%$ ), which will be the PNP output voltage level when using only the internal supply.*

*If additional PNP output sourcing current or a higher output voltage level is desired, an external DC supply may be connected between the "DC Out/In" and "Comm." terminals. This supply will determine the PNP output voltage level, and must be in the range of +13 to +30 VDC.*

*An external supply can provide the additional output sourcing current required in applications where two or more outputs are "ON" simultaneously. However, the maximum rating of 100 mA per individual output must not be exceeded, regardless of external supply capacity.*

8. **OUTPUTS:** (Output type and quantity, model dependent) **Cont'd**

**Relay:** Form A contact, Rating = 5 A @ 250 VAC, 30 VDC (resistive load), 1/10 HP @ 120 VAC (inductive load)

**Relay Life Expectancy:** 100,000 cycles min. at max. load rating

**Programmable Timed Output:** User selectable output time resolution.

**0.01 Second Resolution:** 0.01 to 99.99 sec, ± 0.01% +20 msec max. (Prescalers less than 2)

**0.1 Second Resolution:** 0.1 to 999.9 sec, ± 0.01% + 100 msec (Prescalers less than 2)

*Note: For Prescaler values above 2, the timed delay output is affected by the count speed (rate).*

9. **RS485 SERIAL COMMUNICATIONS (Optional):** Up to 32 units can be connected.

**Baud Rate:** Programmable from 1200 to 9600 baud

**Address:** Programmable from 0 to 99

**Data Format:** 10 Bit Frame, 1 start bit, 7 or 8 data bits, 1 or No Parity bit, and 1 stop bit

**Parity:** Programmable for Odd (7 data bits), Even (7 data bits), or None (8 data bits)

10. **CERTIFICATIONS AND COMPLIANCES:**

UL Recognized Component, File #E137808

Recognized to U.S. and Canadian requirements under the Component Recognition Program of Underwriters Laboratories, Inc.

**ELECTROMAGNETIC COMPATIBILITY**

**Immunity to EN 50082-2**

Electrostatic discharge	EN 61000-4-2	Level 2; 4 Kv contact Level 3; 8 Kv air
Electromagnetic RF fields	EN 61000-4-3	Level 3; 10 V/m 80 MHz - 1 GHz
Fast transients (burst)	EN 61000-4-4	Level 4; 2 Kv I/O Level 3; 2 Kv power
RF conducted interference	EN 61000-4-6	Level 3; 10 V/rms 150 KHz - 80 MHz
Simulation of cordless telephone	ENV 50204	Level 3; 10 V/m 900 MHz ± 5 MHz 200 Hz, 50% duty cycle

**Emissions to EN 50081-2**

RF interference	EN 55011	Enclosure class A
-----------------	----------	-------------------

*Notes:*

**AC VERSIONS**

1. A power line filter, RLC#LFIL0000 or equivalent, was installed when the unit was DC powered.

**DC VERSIONS**

To insure compliance with the EMC standards listed above, do not connect any wires from the terminal(s) labeled "COMM." to the "DC-" supply terminal (12), when powering the unit from a DC supply.

Refer to EMC Installation Guidelines section of the manual for additional information.

11. **ENVIRONMENTAL CONDITIONS:**

**Operating Temperature:** 0°C to 50°C

**Storage Temperature:** -40°C to 70°C

**Operating and Storage Humidity:** 85% max. relative humidity (non-condensing) from 0°C to 50°C.

**Altitude:** Up to 2000 meters

12. **ELECTRICAL CONNECTIONS:** Wire clamping screw terminals.

13. **CONSTRUCTION:** Black plastic case with collar style panel latch. The panel latch can be installed for horizontal or vertical stacking. Black plastic textured bezel with clear display viewing window. Unit assembly with circuit boards can be removed from the case without removing the case from the panel or disconnecting the wiring. Front panel meets NEMA 4X/IP65 requirements for indoor use, when properly installed. Installation Category II, Pollution Degree 2.

14. **WEIGHT:** 6.0 oz (170 g)

**SINGLE PRESET MODELS**

The C48CS has a solid-state output that operates in parallel with a relay output. The solid-state output is available as an NPN or PNP open collector transistor.

**DUAL PRESET MODELS**

The C48CD has two outputs that are activated from presets 1 and 2 respectively. These outputs can be relay outputs, or solid-state outputs. The solid-state outputs are available as NPN or PNP open-collector transistors. Units with solid-state outputs can be ordered with an optional prescaler output (C48CP).

**3 PRESET BATCH MODELS**

The C48CB has a secondary counter that can be used for batch counting, or to keep a total count. This second counter can be programmed to operate in one of eight operating modes. Outputs 1 and 2 are assigned to the primary process counter (C1). Output 3 is assigned to the secondary Batch/Total counter (C2). The three preset batch unit can be ordered with solid-state or relay outputs. Units with solid-state outputs have a User Input 2 terminal available. The relay model has a relay output for Output 2 and Output 3 (Batch/Total). Output 1 is available only as solid-state.

**PRESCALER OUTPUT MODELS**

The C48CP is a dual preset counter with solid-state outputs. These models have an additional output configured as a prescaler output. Each time the least significant digit of the display increments, the Prescaler output provides a pulse. The width of this pulse is variable in that the output will turn off after a programmed number of count input pulses has occurred (1-9). The Prescaler output can also be programmed to activate when the 10's digit of the display increments, rather than the least significant digit.

*Note: Prescaler Output models are limited to two programmable count modes and prescaler values of 1.00000 or less. See Count Input Modes for available modes.*

**FRONT PANEL FEATURES**

The C48 Counters feature a dual line display. In the normal operating mode (main display), the count or batch/total value is shown on the top line and presets, prescaler, or output time values are shown on the bottom line. The bottom line values can be programmed to be viewable only, viewable and changeable, or locked (not viewable) from the main display.

In the operating mode, the presets, prescaler, and output time values are accessible providing that these values are not programmed for 'L'ocked. Values that are accessible (changeable) can be changed immediately when viewed in the secondary display.

**FRONT PANEL KEYPAD**



- Performs user Programmed Function



- Cycles through secondary displays.  
- Enters Protected Value Menu or Programming Mode when pushed and held for 2 seconds.  
- Scrolls through programming parameters.  
- Enters Data Values.





- Selects next available mode in programming mode.  
- Increments digit in Digit Entry mode.  
- Increments value in Auto Scrolling entry mode.



- Selects Digit to right when in Digit Entry mode.  
- Decrements value in Auto Scrolling entry mode.

## USER INTERFACE/PROGRAMMING MODES

The operating modes of the C48C are programmed using the front panel keypad. To enter the programming menu, the  key is pushed and held for 2 seconds. Within the programming menu, the  key is used to sequence through the list of programming parameters.

### PROGRAMMING MENU

- EntRy** - Digit or Auto Scrolling Data Entry Mode
- Rc PSc** - Accessibility of Prescaler Value
- PScALr** - Prescaler Value
- dEc Pt** - Decimal Point Position
- Cnt In** - Count Input Modes
- OPER 1** - Counter 1 Operating Mode
- C2 ASn** - Counter 2 Assignment (C48CB only)
- OPER 2** - Counter 2 Operating Mode (C48CB only)
- Rc PrS** - Accessibility of Preset Values
- PrESEt** - Preset 1, 2, and 3 Values
- P1trAC** - P1 Track P2 (not available on C48CS)
- Rc Out** - Accessibility of Output Time Values
- OutRES** - Output Resolution
- OutPnt** - Output 1, 2, and 3 Time Values
- rEUOut** - Reverse Output/Relay Logic
- rEURnu** - Reverse Output Annunciator Logic
- OutPwP** - Power Up Output State
- USr In 1** - User Input 1
- USr In 2** - User Input 2 (Not available on Batch Relay Models)
- USr In b** - User Input b
- USr F1** - User F1 Key
- Code** - Programming/Protected Parameter menu Code
- ScroLL** - Scroll Display
- SErSEt** - Serial Baud Rate & Parity Settings
- SErAdr** - Serial Unit Address
- SErAbr** - Abbreviate Serial Mnemonics (RS485 option only)
- PrnOPt** - Print Options
- PrnrSt** - Print & Reset Count Value
- PScORt** - Prescaler Output Pulse (C48CP only)
- PScLEn** - Prescaler Output Pulse Length (width) (C48CP only)
- FRcSEt** - Load Factory Default Settings

### Program Security/Operator Accessible Values







The Program Disable DIP switch, programmable code value, User Input (programmed for Program Disable), and the Accessible Value parameters provide various levels of security against unauthorized programming changes. The accessible values parameters provide individual access or locking of each value.

### Protected Value Menu

The Protected Value Menu allows access to selected presets, prescaler and timed output values without having them viewable or changeable from the main display. To enter the protected menu, the  key is pressed and held, and a programmed code value is entered.

### Programming Numeric Data Values

The Presets may be accessible when the unit is in its operating mode. Pressing the  key will sequence the secondary display through the available preset, prescaler and Batch/Total count values.

To change a data value it must be visible on the secondary display. Pressing the  or  key will allow changing of the value. If the data entry method has been set to "digit entry", pressing the  key multiple times will select other digits. Pressing the  key will increment the selected digit. If the data entry method is set to "Auto scrolling", the data value can be changed by pressing and holding the  or  keys to change one or all digits of the display. The data value will be entered when the  key is pushed, or the old value will be retained if no key activity is detected for 10 seconds.

### Count Input Modes - *Cnt In*

This parameter controls the count/control function of Inputs A and B. It also allows Input B to be used as a User Input with the same programmable functions as the dedicated User Inputs.

MODE	INPUT A	INPUT B
<b>C1-USr</b>	Count	User Input *
<b>C2-USr</b>	Count (X2)	User Input
<b>C1-Ud</b>	Count	Up/Dn Control *
<b>C2-Ud</b>	Count (X2)	Up/Dn Control
<b>Ad-Sub</b>	Add Count	Subtract Count
<b>Ad-Ad</b>	Add Count	Add Count
<b>QUAd 1</b>	Quad X1 Inputs	
<b>QUAd 2</b>	Quad X2 Inputs	
<b>QUAd 4</b>	Quad X4 Inputs	

\* These are the only count input modes available on the Prescaler Output Model.

### Programmable Operating Modes - *OPER*

These modes determine the operational characteristics of the counter. In the tables, 01, 02, and 03, refer to Outputs 1, 2, and 3 respectively.

SINGLE PRESET OPERATING MODES	
1	- Manual Reset to Zero, Latched Output
2	- Manual Reset to Zero, Timed Output
3	- Manual Reset to Preset, Latched Output
4	- Manual Reset to Preset, Timed Output
5	- Auto Reset to Zero, Timed Output
6	- Auto Reset to Preset, Timed Output
7	- Auto Reset to Zero at Timed Output End
8	- Auto Reset to Preset at Timed Output End

DUAL PRESET AND BATCH COUNTER 1 OPERATING MODES	
1	- Manual Reset to Zero, Latched Outputs
2	- Manual Reset to Zero, 01 Timed, 02 Latched
3	- Manual Reset to Zero, 01 and 02 Timed
4	- Manual Reset to Zero, 01 off at 02, 02 Latched
5	- Manual Reset to Zero, 01 off at 02, 02 Timed
6	- Manual Reset to Preset 2, Latched Outputs
7	- Manual Reset to Preset 2, 01 Timed, 02 Latched
8	- Manual Reset to Preset 2, 01 and 02 Timed
9	- Manual Reset to Preset 2, 01 off at 02, 02 Latched
10	- Manual Reset to Preset 2, 01 off at 02, 02 Timed
11	- Auto Reset to Zero, 01 and 02 Timed
12	- Auto Reset to Zero, 01 off at 02, 02 Timed
13	- Auto Reset to Preset 2, 01 and 02 Timed
14	- Auto Reset to Preset 2, 01 off at 02, 02 Timed
15	- Auto Reset to Zero at 02 End, 01 and 02 Timed
16	- Auto Reset to Zero at 02 End, 01 off at 02, 02 Timed
17	- Auto Reset to Preset 2 at 02 End, 01 and 02 Timed
18	- Auto Reset to Preset 2 at 02 End, 01 off at 02, 02 Timed

COUNTER 2 OPERATING MODES (C48CB Only)	
1	- Manual Reset to Zero, 03 Latched
2	- Manual Reset to Zero, 03 Timed
3	- Manual Reset to Preset 3, 03 Latched
4	- Manual Reset to Preset 3, 03 Timed
5	- Auto Reset to Zero, 03 Timed
6	- Auto Reset to Zero at 03 Timed Output End
7	- Auto Reset to Preset 3, 03 Timed
8	- Auto Reset to Preset 3 at 03 Timed Output End

## MULTIPLE UNIT STACKING

The C48C is designed for close spacing of multiple units. Units can be stacked either horizontally or vertically. For vertical stacking, install the panel latch with the screws to the sides of the unit. For horizontal stacking, the panel latch screws should be at the top and bottom of the unit. The minimum spacing

from center line to center line of the units is 1.96" (49.8 mm). This spacing is the same for vertical or horizontal stacking.

*Note: When stacking units, provide adequate panel ventilation to ensure that the maximum operating temperature range is not exceeded.*

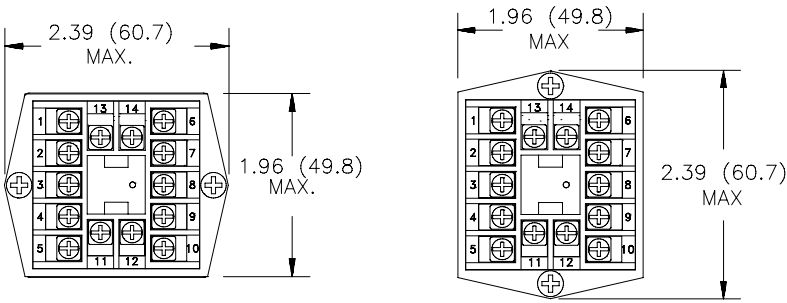

PANEL LATCH INSTALLED FOR VERTICAL UNIT STACKING

PANEL LATCH INSTALLED FOR HORIZONTAL UNIT STACKING

PANEL CUT-OUT SPACING FOR MULTIPLE UNIT STACKING. HORIZONTAL ARRANGEMENT SHOWN.

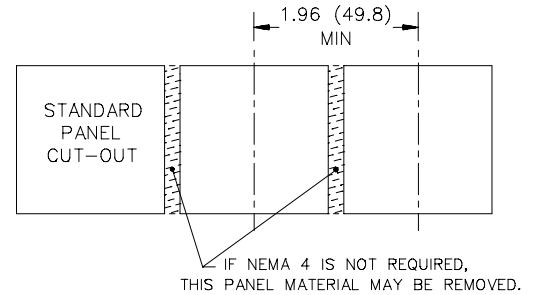

## SLOW DOWN & CUT TO LENGTH WITH TOTAL FOOTAGE

To improve production efficiency, a wallpaper manufacturing plant is installing cut to length counters on the roll form machines. Currently, electro-mechanical counters are used for length measurements. The operator slows the machine down upon arriving at the desired length, stops and then cuts. The addition of the C48CB batch counters eliminates the operator's manual observation and control.

The operator programs the required cut length as Preset 2. Preset 1 is preprogrammed for tracking and will automatically follow Preset 2. Preset 1 is used as the slow down, and is set for a value 0.25 yards less than Preset 2. The process count is programmed to automatically reset at the Preset 2 cut length of 11.00 yards, and begin counting for the next roll. Counter 2 is programmed as a totalizer and is recorded and reset (via key switch) at the end of the operator's shift. The C48CB was ordered with the RS-485 serial communication option. Future plans include a data acquisition program to interrogate the C48CB's. A 100 ppr rotary pulse generator is shaft coupled to a 4" pinch roller for length measurement. Display units desired is 0.01 yards. Program Security features are set to allow access to Preset 2 only. This allows the operator to change the required cut length, but prevents accidental changes to other programming parameters that may adversely affect process operation. After all programming is complete, the Program Disable DIP switch is moved to the up position to enable the Program Security function.

### Circumference Of Pinch Roller:

$$\text{circumference} = \pi \times \text{diameter}$$

$$12.56636 = 3.14159 \times 4.00$$

### Pulses Per Yard:

$$\frac{36 \text{ inches}}{1 \text{ yard}} \times \frac{1 \text{ rev}}{12.56636"} = 2.8647913 \text{ rev/yard}$$

$$2.8647913 \text{ rev/yard} \times 100 \text{ ppr/rev} = 286.47913 \text{ pulses/yard}$$

### Prescaler:

$$\text{Prescaler} = \frac{\text{Display units}}{\text{number of pulses}}$$

$$= \frac{100}{286.47913}$$

$$\text{Prescaler} = 0.34907$$

### Products:

C48CB108  
RPGQ0100

## PROGRAMMING

<b>Ent r Y</b>	<b>Ru k o S c</b>
<b>R c P S c</b>	<b>-L (locked)</b>
<b>P S c R L r</b>	<b>0.34907</b>
<b>d E c P t</b>	<b>--- --</b>
<b>Ent In</b>	<b>9999 1</b>
<b>O P E r 1</b>	<b>12</b>
<b>C 2 R S n</b>	<b>to t a l</b>
<b>O P E r 2</b>	<b>02</b>
<b>R c P r S</b>	<b>-L-Y-L</b>
<b>P r E S E t</b>	<b>PRS1 10.75 (value 0.25 less than PRS2 for slowdown)</b>
<b>P r E S E t</b>	<b>PRS2 11.00 (cut length)</b>
<b>P r E S E t</b>	<b>PRS3 999999 (Set high so output does not activate)</b>
<b>P l t r R c</b>	<b>Y E S</b>
<b>R c O u t</b>	<b>-L-L-L</b>
<b>O u t R E S</b>	<b>00 15 E E</b>
<b>O u t P u t</b>	<b>1 t 0.10</b>
<b>O u t P u t</b>	<b>2 t 100</b>
<b>O u t P u t</b>	<b>3 t 0.10</b>
<b>r E U O u t</b>	<b>- - - - -</b>
<b>r E U R n u</b>	<b>- - - - -</b>
<b>O u t P u P</b>	<b>- F - F - F</b>
<b>U S r In t</b>	<b>r S t 2 - E</b>
<b>U S r F t</b>	<b>r S t - E</b>
<b>C o d E</b>	<b>003</b>
<b>S c r o l L</b>	<b>n o</b>
<b>S E r S E t</b>	<b>96 n</b>
<b>S E r A d r</b>	<b>00</b>
<b>S E r A b r</b>	<b>n o</b>
<b>P r n O P t</b>	<b>00</b>
<b>P r n r S e t</b>	<b>n o</b>
<b>F R c S E t</b>	<b>n o</b>

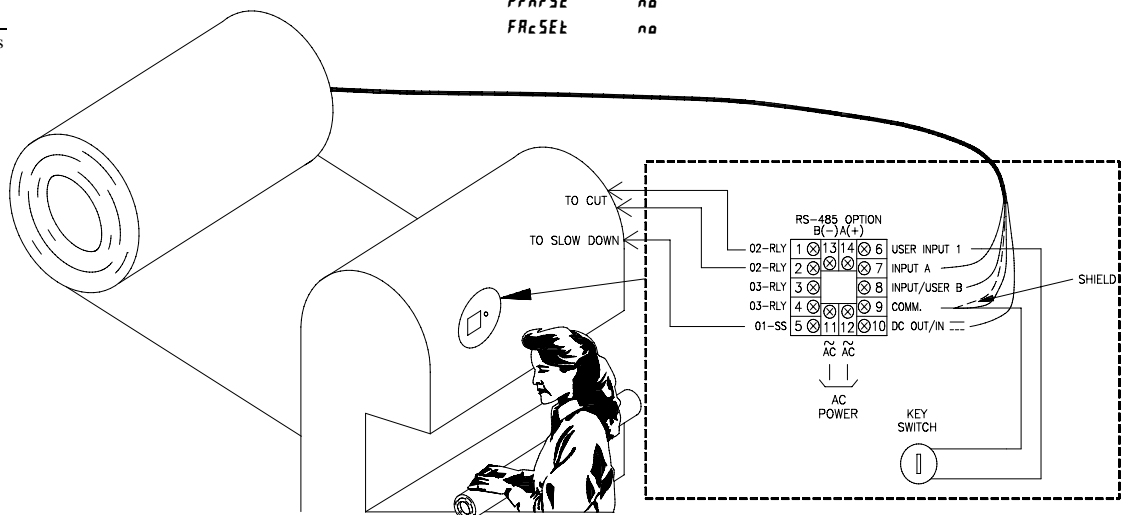

## ORDERING INFORMATION

MODEL NO.	DESCRIPTION	*NPN O.C. OUTPUT(S)	RELAY OUTPUT(S) (Note)	RS485	PART NUMBERS FOR AVAILABLE SUPPLY VOLTAGES	
					18-36 VDC/24 VAC	85 to 250 VAC
C48CS	1 Preset Counter, Reflective LCD	Yes	Yes	No	C48CS013	C48CS003
	1 Preset Counter, Backlit LCD	Yes	Yes	No	C48CS113	C48CS103
C48CD	2 Preset Counter, Reflective LCD	Yes	No	Yes	C48CD015	C48CD005
	2 Preset Counter, Reflective LCD	No	Yes	No	C48CD012	C48CD002
	2 Preset Counter, Reflective LCD	No	Yes	Yes	C48CD017	C48CD007
	2 Preset Counter, Backlit LCD	Yes	No	No	C48CD110	C48CD100
	2 Preset Counter, Backlit LCD	Yes	No	Yes	C48CD115	C48CD105
	2 Preset Counter, Backlit LCD	No	Yes	No	C48CD112	C48CD102
	2 Preset Counter, Backlit LCD	No	Yes	Yes	C48CD117	C48CD107
C48CP	2 Preset Counter w/Prescaler Output, Reflective LCD	Yes	No	Yes	C48CP015	C48CP005
	2 Preset Counter w/Prescaler Output, Backlit LCD	Yes	No	No	C48CP110	C48CP100
	2 Preset Counter w/Prescaler Output, Backlit LCD	Yes	No	Yes	C48CP115	C48CP105
C48CB	3 Preset Batch Counter, Reflective LCD	Yes (O1)	Yes	No	N/A	C48CB003
	3 Preset Batch Counter, Reflective LCD	Yes (O1)	Yes	Yes	N/A	C48CB008
	3 Preset Batch Counter, Reflective LCD	Yes	No	Yes	N/A	C48CB005
	3 Preset Batch Counter, Backlit LCD	Yes (O1)	Yes	No	N/A	C48CB103
	3 Preset Batch Counter, Backlit LCD	Yes (O1)	Yes	Yes	N/A	C48CB108
	3 Preset Batch Counter, Backlit LCD	Yes	No	No	C48CB110	C48CB100
	3 Preset Batch Counter, Backlit LCD	Yes	No	Yes	N/A	C48CB105

Note: On Batch Relay Models, Outputs 2 and 3 are Relays, and Output 1 (O1) is a solid-state output.

\* PNP O.C. output(s) versions available, contact the factory.

### RELAY OUTPUT BOARDS

MODEL NO.	DESCRIPTION	NPN O.C. OUTPUT(S)	PNP O.C. OUTPUT(S)	RELAY OUTPUT(S)	PART NUMBER
RBC48	Single Preset	Yes	No	Yes	RBC48001
		No	Yes	Yes	RBC48002
	Dual Preset	No	No	Yes	RBC48003
	Batch	Yes	No	Yes	RBC48004
		No	Yes	Yes	RBC48005

### ACCESSORIES

MODEL	DESCRIPTION	PART NUMBER
SFC48	PC Configuration Software for Windows 3.x and 95 (3.5" disk) (for RS-485 Models)	SFC48