

MODEL LNXC1 SINGLE PRESET COUNTER MODEL LNXC2 DUAL PRESET COUNTER

- 0.3" (7.6 mm) HIGH, 6 DIGIT DISPLAY
- NON-VOLATILE MEMORY (E²PROM)
- DISPLAY SCROLLING (SELECTABLE)
- BI-DIRECTIONAL COUNTING
- PRESCALE CAPABILITY WITH DISABLE SWITCH (Dual Preset)
- FORM C RELAY OUTPUT(S)
- SOLID-STATE CURRENT SINKING OUTPUT(S)
- PROGRAMMABLE TIMED OUTPUT(S)
- REMOTE RESET CAPABILITY
- ABILITY TO LOCK OUT FRONT PANEL FUNCTIONS
- ACCEPTS INPUT COUNT RATES UP TO 15 KHz (Single preset)
- AVAILABLE IN AC OR DC VERSIONS
- FRONT PANEL PROGRAMMABLE DECIMAL POINT
- SEALED FRONT PANEL CONSTRUCTION (NEMA 4X/IP65)



DESCRIPTION

The Lynx Series of presettable counters is an economical and reliable solution to single or dual preset level requirements. The Model LNXC1 is the single preset version and the Model LNXC2 is the dual preset version. Both units have a solid-state output and a Form C relay output for each preset. These units feature selectable input configurations, a full compliment of control inputs, programmable timed outputs, prescale capability with disable switch (*dual preset only*), non-volatile memory, and many other features which will satisfy most any single or dual preset application.

The Lynx Counters have two main counting actions, Reset to Zero (*RTZ*) and Reset to Preset (*RTP*). There are eight modes of operation for the single preset unit and sixteen for the dual preset unit.

All parameters are programmed through the front panel buttons. The Lynx counters have an internal non-volatile memory device which eliminates the need for battery back-up. When power is removed, this device will maintain all data set-ups necessary for system operation. A Program Disable terminal is provided, which can be used to prevent accidental changes or tampering by unauthorized personnel to the preset(s), prescale or timed output values. The front panel reset button can also be enabled or disabled by a rear panel DIP switch. These counters also have an on-line self-test, which can be run at any time without missing counts or missing a preset value.

Power, input, and output connections are made via removable terminal blocks at the rear of the unit. The Lynx Series of counters have a sealed high impact plastic bezel and meet NEMA 4X/IP65 specifications for wash-down and/or dust, when properly installed.

SAFETY SUMMARY

All safety related regulations, local codes and instructions that appear in the manual or on equipment must be observed to ensure personal safety and to prevent damage to either the instrument or equipment connected to it. If equipment is used in a manner not specified by the manufacturer, the protection provided by the equipment may be impaired.

Do not use this unit to directly command motors, valves, or other actuators not equipped with safeguards. To do so, can be potentially harmful to persons or equipment in the event of a fault to the unit.

SPECIFICATIONS

1. **DISPLAY:** 6-digit, 0.3" (7.6 mm) high LCD display.
2. **POWER REQUIREMENTS:**
 - AC Power Versions:** 115 VAC ($\pm 10\%$), 50/60 Hz, 6 VA
230 VAC ($\pm 10\%$), 50/60 Hz, 6 VA
 - DC Power Versions:** 11 to 14 VDC @ 180 mA.
21.5 to 30 VDC @ 180 mA.
3. **SENSOR POWER:** +12 VDC ($\pm 25\%$) @ 100 mA.
4. **COUNT INPUT:** DIP switch selectable to accept count pulses from a variety of sources, including switch contacts, outputs from CMOS or TTL circuits, and all standard RLC sensors.
 - Current Sourcing:** Unit provides 3.9 K Ω pull-down load for sensors with current sourcing outputs. (Max. input voltage, 28 VDC @ 7 mA.)
 - Current Sinking:** Unit provides 7.8 K Ω pull-up to +12 VDC for sensors with current sinking outputs. (Max. sensor current, 1.6 mA.)
 - Debounce:** Damping capacitor provided for switch contact debounce. Limits count speed to 100 cps max. with 50% duty cycle.
 - Lo Bias:** Input Trigger levels $V_{IL} = 1.5$ V, $V_{IH} = 3.75$ V
 - Hi Bias:** Input Trigger levels $V_{IL} = 5.5$ V, $V_{IH} = 7.5$ V
 - Note: Bias levels $\pm 10\%$ @ 12 VDC sensor voltage. These levels vary proportionally with the sensor supply voltage.*
5. **PRESCALE VALUE RANGE:** 0.00001 to 9.99999 (dual preset unit only).

CAUTION: Read complete instructions prior to installation and operation of the unit.

CAUTION: Risk of electric shock.

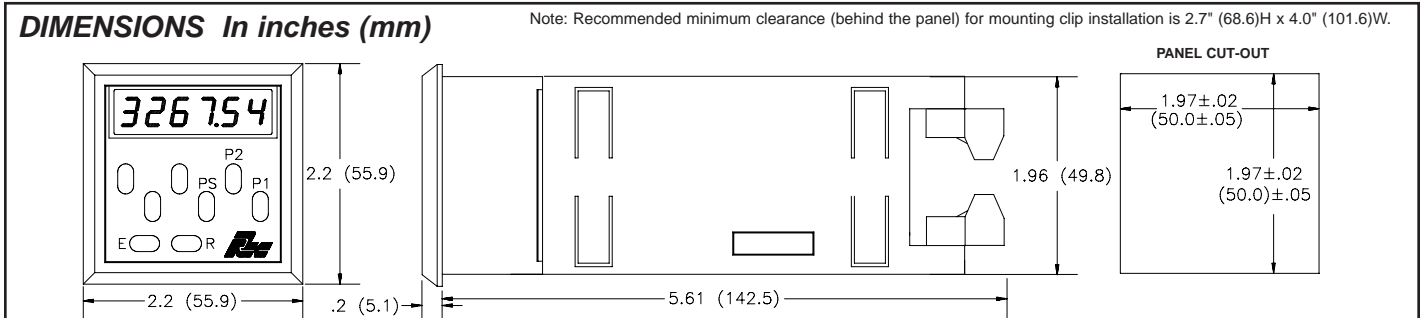

BLOCK DIAGRAM

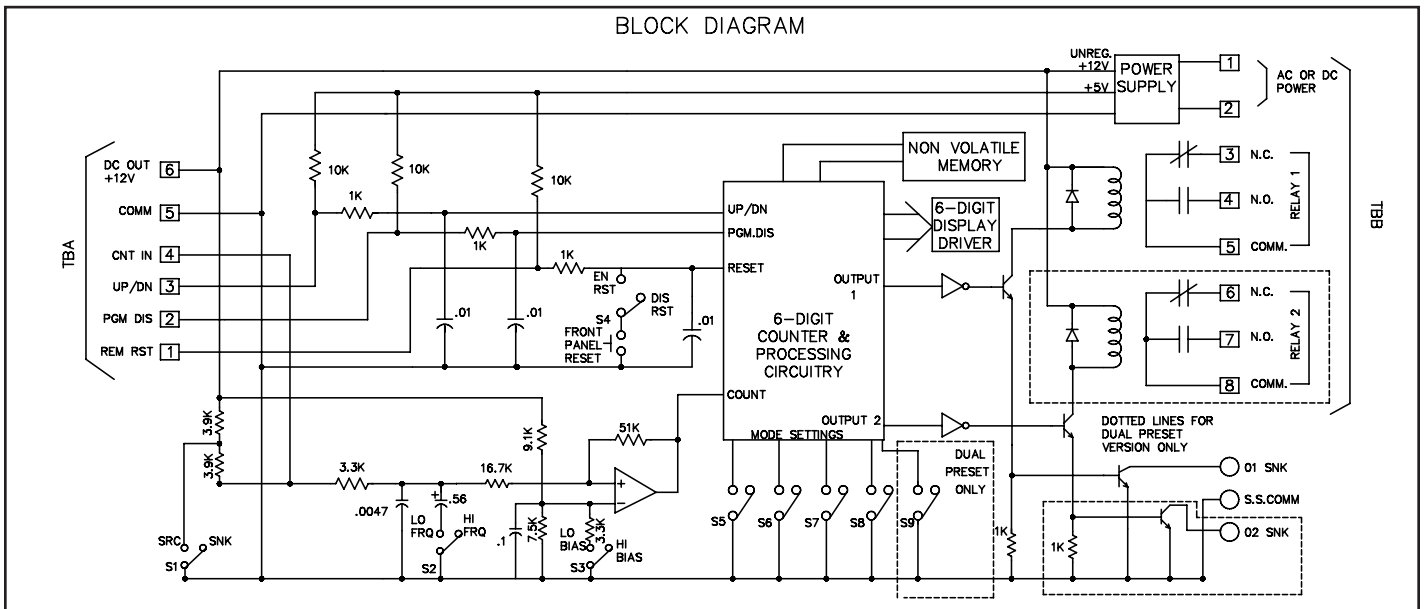

SPECIFICATIONS (Cont'd)

6. MAXIMUM COUNT RATES:

High Frequency: For the single preset unit only - 15 KHz max. square wave input for all electronic sensors, under all modes of operation. For dual preset units, the following chart lists the count rates for all the possible prescale values.

DUAL PRESET UNITS ONLY	
Prescale Value	Frequency
0.00001 to 1	12 KHz
1.00001 to 2	9 KHz
2.00001 to 3	7 KHz
3.00001 to 4	5.5 KHz
4.00001 to 5	4.5 KHz
5.00001 to 6	4 KHz
6.00001 to 7	3.5 KHz
7.00001 to 8	3 KHz
8.00001 to 9	3 KHz
9.00001 to 9.99999	2.5 KHz

Note: For prescale values greater than 7, the timed delay output is affected by the count speed (rate).

Low Frequency: both single and dual preset units - 100 Hz for switch contact closures. *Note: These units will operate with VCM (E through H) modules.*

7. CONTROL INPUTS: Active low ($V_{IL} = 0.5$ V max.), internally pulled up to 5 VDC through a 10 K Ω resistor ($I_{SNK} = 0.5$ mA).

Remote Reset: Response time = 10 msec. A low will reset the unit and deactivate outputs.

Program Disable: A low will inhibit the changing of presets, prescale, and timed outputs, as well as testing outputs in self-test.

Up/Down Control: Response time = 150 μ sec. A low will cause the unit to count down. A high will cause the unit to count up.

8. OUTPUTS:

Solid-State: Current sinking NPN Open Collector Transistors. $I_{SNK} = 100$ mA max., $V_{OH} = 30$ VDC max., $V_{OL} = 1$ V @ 100 mA.

Relay: Form C contacts max. rating 5 amps @ 120/240 VAC, 28 VDC (resistive load), 1/8 H.P. @ 120 VAC (inductive load). The operate time is 5 msec. nominal and the release time is 3 msec. nominal.

Relay Life Expectancy - 100,000 cycles at max. rating. *(As load level decreases, life expectancy increases.)*

Programmable Timed Output: The timed output can be programmed from 0.01 sec. to 99.99 sec., $\pm 0.1\% + 10$ msec. The timed output is set for 0.1 sec. at the factory.

9. MEMORY RETENTION: Non-volatile E²PROM retains all programmed information when power is removed or interrupted.

10. INPUT, POWER, AND OUTPUT CONNECTIONS: Removable terminal blocks.

11. ENVIRONMENTAL CONDITIONS:

Operating Temperature: 0 to 50°C

Storage Temperature: -40 to 70°C

Operating and Storage Humidity: 85% max. relative humidity (non-condensing) from 0°C to 50°C.

Altitude: Up to 2000 meters

12. CERTIFICATIONS AND COMPLIANCES:

SAFETY

IEC 1010-1, EN 61010-1: Safety requirements for electrical equipment for measurement, control, and laboratory use, Part 1.

IP65 Enclosure rating (Face only), IEC 529

Type 4X Enclosure rating (Face only), UL50

ELECTROMAGNETIC COMPATIBILITY

Immunity to EN 50082-2

Electrostatic discharge	EN 61000-4-2	Level 2; 4 Kv contact Level 3; 8 Kv air
Electromagnetic RF fields	EN 61000-4-3	Level 3; 10 V/m 80 MHz - 1 GHz
Fast transients (burst)	EN 61000-4-4	Level 4; 2 Kv I/O ² Level 3; 2 Kv power ¹
RF conducted interference	EN 61000-4-6	Level 3; 10 V/rms ¹ 150 KHz - 80 MHz

Emissions to EN 50081-2

RF interference	EN 55011	Enclosure class A Power mains class A
-----------------	----------	--

Notes:

1. Power lines had an external EMI line filter (RLC #LFIL0000 or equivalent) installed.

2. I/O cables routed in metal conduit connected to earth ground.

Refer to the EMC Installation Guidelines section of the bulletin for additional information.

13. CONSTRUCTION: Black plastic front bezel with black plastic insert. Front panel meets NEMA 4X/IP65 requirements for wash-down and dusty environments, when properly installed. Installation Category II, Pollution Degree 2. (Panel gasket, mounting clip, nut fasteners, and screws included with unit.)

14. WEIGHT: 0.8 lbs (0.36 kg).

FRONT PANEL FUNCTION DESCRIPTION

The units employ eight front panel buttons for control and data entry. The button functions are as described below:

RESET "R": Resets the counter to either zero or preset, depending on the mode of operation selected. For this button to operate, the enable/disable reset switch at the rear of the unit must be set to the enable (EN.) position. The reset button is also used in conjunction with the preset button(s), to view and change the timed output value(s). When reset is activated, all processes are stopped or interrupted (i.e. outputs turn off, display is reset, etc.). This is the case under any mode of operation, in any data entry mode.

PRESET "P1" ("P2"): Labeled P1 and P2 (single preset units only have the P1 preset button).

The preset 1 value is displayed when the P1 button is pressed, and the Preset Value mode is accessed (See Program Preset Value). The value remains displayed for approximately 10 seconds after the button is released. The preset buttons are also used, in conjunction with the reset button, to view and change the timed output values (See Program Timed Output Value section.)

ENTER "E": Used when programming the Preset Value or the Timed Output Value. After the desired value is obtained on the display, pressing the E

button enters the value into the unit's internal memory and takes effect immediately. Also the "E" button can be used to exit self-test.

PRESCALE "PS": Available only on a dual preset unit. When the "PS" button is pressed, the prescale value can be programmed (See Program Prescale Value). This value remains displayed for approximately 10 seconds after the button is released.

INPUT CONFIGURATION & FRONT PANEL RESET, DIP SWITCH SET-UP

The DIP switches are located at the rear of the unit. DIP switches 1 to 3 configure the type of input signal, and DIP switch 4 enables or disables the front panel reset button. Refer to the block diagram of the unit for the details of count and control circuitry.

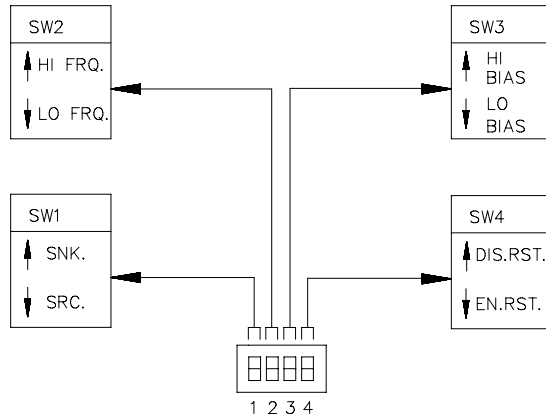

SWITCH SET-UP

- S1 - SNK.:** Provides a 7.8 K Ω pull-up resistor for sensors with sinking outputs.
- SRC.:** Provides a 3.9 K Ω pull-down resistor for sensors with sourcing outputs.
- S2 - HI FRQ.:** Removes damping capacitor and allows operation up to the maximum frequency (See max count rates in specifications).
- LO FRQ.:** Connects damping capacitor for switch contact de-bounce. Limits count speed to 100 cps. Minimum count ON/OFF times - 5 msec.
- S3 - HI BIAS:** Sets input trigger levels at mid-range, to accept outputs from 2-wire proximity sensors, resistive photo-cells, and logic pulses with full 0 to +12 V swings. ($V_{IL} = 5.5$ V, $V_{IH} = 7.5$ V).
- LO BIAS:** Sets input trigger levels to the low range, to accept logic pulses with 0 to +5 V swings. ($V_{IL} = 1.5$ V, $V_{IH} = 3.75$ V).
- S4 - DIS.RST.:** Disables front panel reset.
- EN. RST.:** Enables front panel reset.

POWER-UP DIAGNOSTICS

Upon applying power, the Lynx counters perform an internal self-diagnostic test of all the stored data. If the tests do not agree, a "P" appears on the right side of the display. Normal operation of the unit will continue while the "P" is displayed. Press the "E" button to remove the "P" and check all data set-up values to be certain they are correct.

EMC INSTALLATION GUIDELINES

Although this unit is designed with a high degree of immunity to ElectroMagnetic Interference (EMI), proper installation and wiring methods must be followed to ensure compatibility in each application. The type of the electrical noise, source or coupling method into the unit may be different for various installations. The unit becomes more immune to EMI with fewer I/O connections. Cable length, routing and shield termination are very important and can mean the difference between a successful installation or a troublesome installation. Listed below are some EMC guidelines for successful installation in an industrial environment.

1. Use shielded (screened) cables for all Signal and Control inputs. The shield (screen) pigtail connection should be made as short as possible. The connection point for the shield depends somewhat upon the application. Listed below are the recommended methods of connecting the shield, in order of their effectiveness.
 - a. Connect the shield only at the panel where the unit is mounted to earth ground (protective earth).
 - b. Connect the shield to earth ground at both ends of the cable, usually when the noise source frequency is above 1 MHz.
 - c. Connect the shield to common of the unit and leave the other end of the shield unconnected and insulated from earth ground.

2. Never run Signal or Control cables in the same conduit or raceway with AC power lines, conductors feeding motors, solenoids, SCR controls, and heaters, etc. The cables should be run in metal conduit that is properly grounded. This is especially useful in applications where cable runs are long and portable two-way radios are used in close proximity or if the installation is near a commercial radio transmitter.
3. Signal or Control cables within an enclosure should be routed as far away as possible from contactors, control relays, transformers, and other noisy components.
4. In extremely high EMI environments, the use of external EMI suppression devices, such as ferrite suppression cores, is effective. Install them on Signal and Control cables as close to the unit as possible. Loop the cable through the core several times or use multiple cores on each cable for additional protection. Install line filters on the power input cable to the unit to suppress power line interference. Install them near the power entry point of the enclosure. The following EMI suppression devices (or equivalent) are recommended:
 - Ferrite Suppression Cores for signal and control cables:
 - Fair-Rite # 0443167251 (RLC #FCOR0000)
 - TDK # ZCAT3035-1330A
 - Steward #28B2029-0A0
 - Line Filters for input power cables:
 - Schaffner # FN610-1.0/7 (RLC #LFIL0000)
 - Schaffner # FN670-1.8/07
 - Corcom #1VR3
- Note:** Reference manufacturer's instructions when installing a line filter.
5. Long cable runs are more susceptible to EMI pickup than short cable runs. Therefore, keep cable runs as short as possible.
6. Switching of inductive loads produces high EMI. Use of snubbers across inductive loads suppresses EMI.

Snubbers:
RLC #SNUB0000

WIRING CONNECTIONS

All conductors should meet voltage and current ratings for each terminal. Also cabling should conform to appropriate standards of good installation, local codes and regulations. It is recommended that power supplied to the unit (AC or DC) be protected by a fuse or circuit breaker.

When wiring the unit, remove the terminal block and use the numbers on the label to identify the position number with the proper function. Strip the wire, leaving approximately 1/4" bare wire exposed (*stranded wires should be tinned with solder*). Insert the wire into the terminal and tighten down the screw until the wire is clamped tightly. Each terminal can accept up to one #14 AWG, two #18 AWG or four #20 AWG wire(s). After the terminal block is wired, install it into the proper location on the PC board. Wire each terminal block in this manner.

Caution: Terminal blocks should **NOT** be removed with power applied to the unit.

INPUT CONNECTIONS

Input connections are made on terminal block TBA, refer to numbers on the label to identify the position number with the proper function. (*The input connections are the same for single or dual preset counters.*) The use of shielded cable is recommended. Follow the EMC Installation Guidelines for shield connection.

Terminal 1 - "REM.RST." (remote reset) When connected to common a manual reset is performed. The output(s) turn off (*if activated*) and the count display is reset. As long as this terminal is low, the unit is held at reset.

Terminal 2 - "PGM.DIS." (program disable) When this terminal is not connected to common, the following values can be programmed using the front panel buttons:

- Preset Value(s)
- Prescale Value (if S9 is UP)
- Decimal Point Position
- Timed Output Value(s)

Outputs can also be tested during self-test under this condition (See Self-Test description for further details). When connected to common, changing these values and testing the outputs is no longer possible.

Terminal 3 - "UP/DN" (count direction control) When this terminal is not connected to common, the count direction is "UP". When connected to common, the count direction is "DOWN".

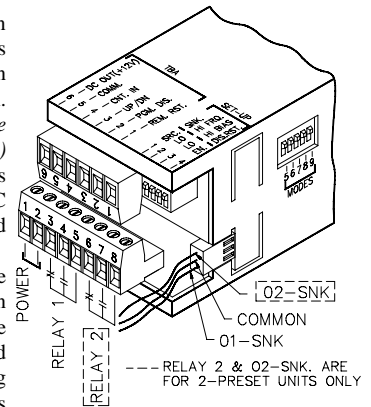

INPUT CONNECTIONS (Cont'd)

Terminal 4 - "CNT.IN" (count input) When the signal is pulled low, a count will be registered. (See *Count Input and Count Rates under the Specifications Section.*)

Terminal 5 - "COMM." (common) Is the common line to which the sensor and other input commons are connected. (Do **NOT** connect relay commons or solid-state output commons to this point.)

Terminal 6 - "DC OUT" (+12 V) This is for sensor supply and can provide up to 100 mA of current.

POWER & OUTPUT CONNECTIONS

The input power and relay output connections are made to the bottom terminal block (TBB), and the solid-state outputs are connected to the polarized three-pin connector.

AC POWER WIRING

Primary AC power is connected to terminals 1 and 2 of TBB (marked VAC 50/60 Hz). To reduce the chance of noise spikes entering the AC line and affecting the unit, the power should be relatively "clean" and within the 10% variation limit. Drawing power from heavily loaded circuits, or from circuits that also power loads that cycle on and off (contactors, relays, motors, machinery, etc.), should be avoided.

DC POWER WIRING

The DC power is connected to terminals 1 and 2 of TBB. The DC plus(+) power is connected to TBB 1 and the minus(-) is connected to TBB 2.

OUTPUT WIRING

Terminals 3, 4, and 5 of TBB are used to connect to output relay 1. Terminals 6, 7, and 8 of TBB (dual preset only) are used to connect to output relay 2 (Refer to block diagram).

The solid-state output connector has three wires (two wires for the single preset unit) for connections.

Yellow wire - Solid-state output 1 (labeled 01 SNK.) internally connects to an NPN Open Collector transistor.

Black wire - common for the solid-state output(s). This terminal should **NOT** be used as the common for the input or control terminals.

Blue wire (dual preset only) - Solid-state output 2 (labeled 02 SNK.) internally connects to an NPN Open Collector transistor.

Relay Connections

To prolong contact life and suppress electrical noise interference due to the switching of inductive loads, it is good installation practice to install a snubber across the contactor. Follow the manufacturer's instructions for installation.

Note: Snubber leakage current can cause some electro-mechanical devices to be held ON.

DISPLAY SCROLLING

To set the display to scroll, press and hold the "E" button and then press the left- most button on the front panel. To stop the scrolling, repeat the above step.

DISPLAY SCROLLING SEQUENCE	
Single Preset	Dual Preset
P1	P1
Value of P1	Value of P1
Count Value	P2
	Value of P2
	Count Value

PRESCALE ENABLE/DISABLE SWITCH (Dual Preset Only)

The Dual Preset Lynx Counters have an extra switch next to the four mode DIP switches which is labeled "PS. EN./DIS." (S9). When this switch is in the enable position (UP), the prescale value can be changed (See Program Prescale Value). When this switch is in the disable position (DOWN), the prescale value cannot be changed.

The prescale value cannot be changed if Program Disable is activated even though the "PS. EN./DIS." switch is in the Enable position.

PROGRAM PRESET VALUE *

The factory default values are set to 500 for preset 1 and 1,000 for preset 2. To enter a different value, the operator must enter the Preset Value Programming Mode by performing the following steps.

Note: During the displaying, changing, and entering of a new preset value, all functions of the unit are operational (i.e. counting, resetting, outputs activating, etc.)

FIRST: Press "P1", (or "P2" if a dual preset unit). This displays the respective preset value, which remains displayed for approximately 10 seconds after release of the button. At this time, the preset display mode can be exited, without change, by pressing the "E" button.

SECOND: Once the preset value is displayed, a specific digit can be incremented by pressing the button directly beneath that digit. Pressing and holding the button down will continuously scroll the digit from 0 through 9, then back to 0 again. When the desired value for that digit is reached, release the button. Repeat this step until the desired preset value is obtained.

THIRD: Press the "E" button to enter the value into the unit's memory. **As Soon As** the "E" button is pressed, the new preset value takes effect. If the "E" button is not pressed within 10 seconds, the unit returns to normal display operation with the previous value retained.

PROGRAM TIMED OUTPUT VALUE *

The factory default Timed Output Value is 0.10 seconds, but can be programmed from 0.01 to 99.99 seconds. To enter a different value, the operator must enter the Timed Output Value Programming Mode by performing the following steps.

Note: During the displaying, changing, and entering of a new timed output value, all functions of the unit are operational (i.e. counting, resetting, outputs activating, etc.)

FIRST: Set S4 Reset "EN./DIS." switch to the "Enable" position.

SECOND: Press and hold the "P1", or "P2" button if a dual preset unit, and then press the "R" button. The respective timed output value is displayed and remains displayed for approximately 10 seconds after release of the button. At this time, the timed output display mode can be exited, without change, by pressing the "E" button.

THIRD: Once the timed output value is displayed, a specific digit can be incremented by pressing the button directly beneath that digit. Pressing and holding the button down will continuously scroll the digit from 0 through 9, then back to 0 again. When the desired value for that digit is reached, release the button. Repeat this step until the desired timed output value is obtained.

FOURTH: Press the "E" button to enter the value into the unit's memory. **As Soon As** the "E" button is pressed, the new timed output value takes effect. If the "E" button is not pressed within 10 seconds, the unit returns to normal display operation with the previous value retained.

PROGRAM PRESCALE VALUE * (Dual Preset Only)

The factory default Prescale Value is 1.00000. To enter a different value, the operator must enter the Prescale Value Programming Mode by performing the following steps.

Note: During the displaying, changing, and entering of a new prescale value, all functions of the unit are operational (i.e. counting, resetting, outputs activating, etc.)

FIRST: Set S9 Prescale "EN./DIS." switch to the "Enable" position.

SECOND: Press the "PS" button. This displays the prescale value which remains displayed for approximately 10 seconds after release of the button. At this time, the prescale mode can be exited without change by pressing the "E" button.

THIRD: Once the prescale value is displayed, a specific digit can be incremented by pressing the button directly beneath that digit. Pressing and holding the button down will continuously scroll the digit from 0 through 9, then back to 0 again. When the desired value for that digit is reached, release the button. Repeat this step until the desired prescale value is obtained.

FOURTH: Press the "E" (Enter) button to enter the value into the unit's memory. **As Soon As** the "E" button is pressed, the new prescale value takes effect. If the "E" button is not pressed within 10 seconds, the unit returns to normal display operation with the previous value retained.

FIFTH: Return S9 to the "Disable" position if desired.

PROGRAM DECIMAL POINT *

The Lynx has the capability of displaying a decimal point in one of five positions. The decimal point selection can be done at any time without missing counts or preset outputs. The factory default for the Decimal Point Position is none. To turn a decimal point on, the operator must enter the Decimal Point Selection Mode by performing the following steps.

Note: During the displaying, changing, and entering of a new decimal point value, all functions of the unit are operational (i.e. counting, resetting, outputs activating)

FIRST: Press and release the left- most button on the front panel. This places the Lynx in the decimal point select mode.

SECOND: Press the digit button which corresponds to the desired decimal point position. A decimal point will appear to the right of the digit selected. If the right- most digit button (P1) is selected, the decimal point is turned off.

THIRD: At the time the decimal point is selected, the unit automatically returns to normal operation. No further action is required by the operator.

* - To enter any new data into the Lynx, the "PGM.DIS." terminal must not be connected to common.

MODES OF OPERATION, DIP SWITCH SET-UP

The DIP switches for the various operating modes are located on the side of the unit. For Reset to Zero modes, the UP/DN terminal is normally **NOT** connected to common (*count up*). For Reset to Preset modes, the UP/DN terminal is normally connected to common (*count down*). The unit will maintain normal operating functions if the direction is reversed.

Note: During automatic reset, no counts will be missed if the count rate does not exceed the maximum count rate specified. A manual reset, either from the

front panel reset (if enabled) or remote reset overrides any condition or state of the counter and begins the cycle again.

Note: In modes four and twelve (Single preset) and in modes four, five, twelve, and thirteen (Dual preset) the output may appear to be latched if the time delay is longer than the time required to count from the reset condition to the preset point.

MODES OF OPERATION FOR SINGLE PRESET LYNX COUNTER

MODE 0 LATCH OUTPUT AT PRESET, MANUAL RESET TO ZERO

The unit counts from zero, when the preset value is reached, the output turns on and counts continue to accumulate. When a manual reset is performed, the count resets to zero and the output turns off.

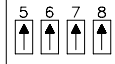

MODE 1 TIMED OUTPUT AT PRESET, MANUAL RESET TO ZERO

The unit counts from zero, when the preset is reached the output turns on for the amount of time programmed and counts continue to accumulate. When a manual reset is performed, the unit resets to zero and starts the cycle again.

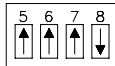

MODE 2 & 3 - *

MODE 4 TIMED OUTPUT AT PRESET, AUTOMATIC RESET TO ZERO AT PRESET

The unit counts from zero, when the preset is reached, the output turns on for the amount of time programmed. At preset, the unit automatically resets to zero and starts the counting cycle over again.

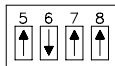

MODE 5 - *

MODE 6 TIMED OUTPUT AT PRESET, AUTOMATIC RESET TO ZERO AFTER THE TIMED OUTPUT

The unit counts from zero, when the preset is reached the output turns on for the amount of time programmed. At the end of the timed output, the unit automatically resets to zero and starts the cycle over again.

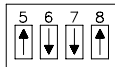

MODE 7 - *

* - These modes are not applicable to the single preset Lynx counter (they are used only for the dual preset counter unit).

MODE 8 LATCH OUTPUT AT ZERO, MANUAL RESET TO PRESET †

The unit counts from preset, when zero is reached the output turns on and counts continue to accumulate. When a manual reset is performed, the unit resets to preset, the output turns off, and the cycle starts again.

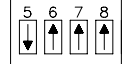

MODE 9 TIMED OUTPUT AT ZERO, MANUAL RESET TO PRESET †

The unit counts from preset, when zero is reached, the output turns on for the amount of time programmed and counts continue to accumulate. When a manual reset is performed, the unit resets to preset and starts the cycle again.

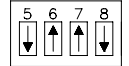

MODE 10 & 11 - *

MODE 12 TIMED OUTPUT AT ZERO, AUTOMATIC RESET TO PRESET AT ZERO †

The unit counts from preset, when zero is reached, the output turns on for the amount of time programmed. At zero, the unit automatically resets to preset and starts the counting cycle again.

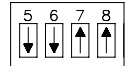

MODE 13 - *

MODE 14 TIMED OUTPUT AT ZERO, AUTOMATIC RESET TO PRESET AFTER THE TIMED OUTPUT†

The unit counts from preset, when zero is reached, the output turns on for the amount of time programmed. At the end of the timed output, the unit automatically resets to preset and starts the cycle over.

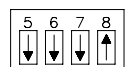

MODE 15 - *

† - When down count is desired, (such as reset to preset modes of operation) the "UP/DN" terminal must be tied to the "COMM." terminal.

MODES OF OPERATION FOR DUAL PRESET LYNX COUNTER

MODE 0 LATCH OUTPUTS AT PRESET, MANUAL RESET TO ZERO

The unit counts from zero, when preset 1 is reached, output 1 turns on and counts continue to accumulate. When preset 2 is reached, output 2 turns on and counts continue to accumulate. When a manual reset is performed, the count resets to zero and the outputs turn off.



MODE 1 TIMED OUTPUTS AT PRESET, MANUAL RESET TO ZERO

The unit counts from zero, when preset 1 is reached, output 1 turns on. When preset 2 is reached, output 2 turns on. Counts continue to accumulate after the preset levels have been reached. The outputs turn off after their respective programmed time values. When a manual reset is performed, the unit resets to zero and starts the cycle again.

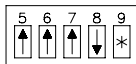

MODE 2 OUTPUT 1 TURN OFF AT PRESET 2, LATCH OUTPUT 2 AT PRESET 2, MANUAL RESET TO ZERO

The unit counts from zero, when preset 1 is reached, output 1 turns on. When preset 2 is reached, output 2 turns on and output 1 turns off. Counts continue to accumulate after the preset levels have been reached. Output 2 remains on until a manual reset occurs. Manual reset turns off both outputs and the count resets to zero.

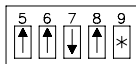

MODE 3 OUTPUT 1 TURN OFF AT PRESET 2, TIMED OUTPUT 2 AT PRESET 2, MANUAL RESET TO ZERO

The unit counts from zero, when preset 1 is reached, output 1 turns on. When preset 2 is reached, output 2 turns on for the amount of time programmed and output 1 turns off. Counts continue to accumulate after the preset levels have been reached. When a manual reset is performed, the count resets to zero.

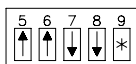

MODE 4 OUTPUT 1 TURN OFF AT PRESET 2, TIMED OUTPUT 2 AT PRESET 2, AUTOMATIC RESET TO ZERO AT PRESET 2

The unit counts from zero, when preset 1 is reached, output 1 turns on. When preset 2 is reached, output 2 turns on for the amount of time programmed. At the beginning of timed output 2, output 1 turns off and the unit automatically resets to zero.

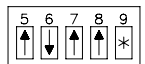

MODE 5 TIMED OUTPUTS AT PRESETS, AUTOMATIC RESET TO ZERO AT PRESET 2

The unit counts from zero, when preset 1 is reached, output 1 turns on, and when preset 2 is reached, output 2 turns on. The outputs turn off at the end of their respective programmed time values. At preset 2, the count automatically resets to zero and starts the cycle again.

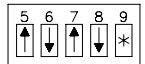

MODE 6 OUTPUT 1 TURN OFF AT PRESET 2, TIMED OUTPUT 2 AT PRESET 2, AUTOMATIC RESET TO ZERO AFTER TIMED OUTPUT 2

The unit counts from zero, when preset 1 is reached, output 1 turns on. When preset 2 is reached, output 2 turns on for the amount of time programmed and output 1 turns off. At the end of timed output 2, the count automatically resets to zero and starts the cycle again.

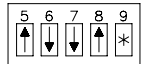

MODE 7 TIMED OUTPUTS AT PRESETS, AUTOMATIC RESET TO ZERO AFTER TIMED OUTPUT 2

The unit counts from zero, when preset 1 is reached, output 1 turns on, and when preset 2 is reached, output 2 turns on. The outputs turn off at the end of their respective programmed time values. At the end of timed output 2, the unit automatically resets to zero and starts the cycle again.

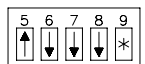

* - Prescale EN./DIS. Switch.

MODES OF OPERATION FOR DUAL PRESET LYNX COUNTER (Cont'd)

MODE 8 LATCH OUTPUT AT PRESET 1 AND ZERO, MANUAL RESET TO PRESET 2 †

The unit counts from preset 2, when preset 1 is reached, output 1 turns on, and when zero is reached, output 2 turns on. Counts continue to register after the outputs have turned on. When a manual reset is performed, the count resets to preset 2 and the outputs turn off.

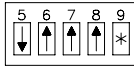

MODE 9 TIMED OUTPUT AT PRESET 1 AND ZERO, MANUAL RESET TO PRESET 2 †

The unit counts from preset 2, when preset 1 is reached, output 1 turns on, and when zero is reached, output 2 turns on. The outputs turn off at the end of their respective programmed time values. Counts continue to accumulate after the outputs have activated. When a manual reset is performed, the count resets to preset 2 and the cycle starts over.

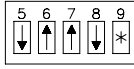

MODE 10 OUTPUT 1 TURN OFF AT ZERO, LATCH OUTPUT 2 AT ZERO, MANUAL RESET TO PRESET 2 †

The unit counts from preset 2, when preset 1 is reached, output 1 turns on. When zero is reached, output 2 turns on and output 1 turns off. Output 2 remains on until a manual reset is performed. Counts continue to accumulate after preset levels have been reached. Manual reset turns off all outputs, if activated, and the count resets to preset 2.

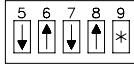

MODE 11 OUTPUT 1 TURN OFF AT ZERO, TIMED OUTPUT 2 AT ZERO, MANUAL RESET TO PRESET 2 †

The unit counts from preset 2, when preset 1 is reached, output 1 turns on. When zero is reached, output 2 turns on for the amount of time programmed and output 1 turns off. Counts continue to accumulate after the preset levels have been reached. When a manual reset is performed, the unit resets to preset 2.

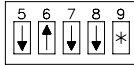

MODE 12 OUTPUT 1 TURN OFF AT ZERO, TIMED OUTPUT 2 AT ZERO, AUTOMATIC RESET TO PRESET 2 AT ZERO †

The unit counts from preset 2, when preset 1 is reached, output 1 turns on. When zero is reached, output 2 turns on for the amount of time programmed, output 1 turns off, and the unit automatically resets to preset 2.

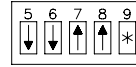

MODE 13 TIMED OUTPUTS AT PRESET 1 AND ZERO, AUTOMATIC RESET TO PRESET 2 AT ZERO †

The unit counts from preset 2, when preset 1 is reached, output 1 turns on. When zero is reached, output 2 turns on and the count automatically resets to preset 2 and the cycle starts over. The outputs turn off at the end of their respective programmed time values.

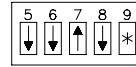

MODE 14 OUTPUT 1 TURN OFF AT ZERO, LATCH OUTPUT 2 AT ZERO, AUTOMATIC RESET TO PRESET 2 AFTER TIMED OUTPUT 2 †

The unit counts from preset 2, when preset 1 is reached, output 1 turns on. When zero is reached, output 2 turns on for the amount of time programmed and output 1 turns off. At the end of timed output 2, the count automatically resets to preset 2 and the cycle starts over.

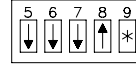

MODE 15 TIMED OUTPUTS AT PRESET 1 AND ZERO, AUTOMATIC RESET TO PRESET 2 AFTER TIMED OUTPUT 2 †

The unit counts from preset 2, when preset 1 is reached, output 1 turns on, and when zero is reached, output 2 turns on. The outputs turn off at the end of their respective programmed time values. At the end of timed output 2, the count automatically resets to preset 2 and the cycle starts over.

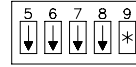

† - When down count is desired, (such as reset to preset modes of operation) the "UP/DN" terminal must be tied to the "COMM." terminal.

*- Prescale EN./DIS. Switch.

SELF-TEST

The self-test feature can be activated without affecting the count, missing a preset point, affecting the timed output durations, or interfering with control functions. This test verifies that all digits operate. Also, the DIP switch settings and the relay outputs can be tested.

If the outputs are not tested, the state(s) of the output(s) remain the same as they were prior to self-test. If the outputs are tested in self-test, the outputs will be off after exiting self-test.

Rapid advance of the self-test routine can be done by pressing and releasing any of the front panel buttons except for the "R" button. (Pressing "R" at any time, except when entering the timed output mode, resets the unit.)

To enter self-test, press the two left-hand digit buttons (on the front panel) simultaneously. At this time, the display will cycle all the digits on the display each for about half a second and in the sequence shown below.

DIGITS CYCLED ON THE DISPLAY

000000
111111
222222
333333
444444
555555
666666
777777
888888
999999

BLANK DISPLAY

101010
121212
323232
343434
545454
565656
767676
787878
989898

The next portion of self-test displays a group of four ones and zeros. The two left-most digits always appear as zeros. The third digit represents the prescale enable/disable DIP switch setting. With prescale enabled, the digit shows a zero, and with it disabled the digit shows a one. The fourth digit represents

program disable (PGM.DIS). A zero represents a high at this terminal and a one represents a low. A second set of digits are the settings of the mode select switches (the four DIP switches located along the side of the unit). This pattern directly corresponds to the number representing the mode of operation. If the switches are changed while at this point in the self-test, the settings can be seen to change. These changes do not affect counter operation immediately, but any changes will take effect when self-test is exited. When the switch is "DOWN", the digit shows a one. When the switch is "UP", the digit shows a zero.

During the time the mode switch settings are displayed, the outputs can be tested. To activate the output(s), press "P1" for output 1 or "P2" for output 2. If no testing of the output(s) is required, press the "E" button until the unit exits self-test (the unit returns to normal display mode). Also, if no activity occurs on the switches or the front panel button within 18 seconds after the unit pauses at the mode switch display, the unit automatically exits self-test.

Note: The "PGM.DIS." terminal must not be connected to common for the outputs to be activated.

Caution: The operator should use care when testing the outputs, so as not to cause any undesirable or hazardous conditions in the system.

INITIAL POWER-UP & FACTORY SETTINGS

When the unit is shipped from the factory, the values and the following modes are set as shown.

Preset 1	=	500
Preset 2	=	1,000 (if a dual preset version)
Prescale Value	=	1.00000 (if a dual preset version)
Count Value	=	0
Timed Output Value(s)	=	0.10 second

DIP SWITCH SETTINGS

All switches are moved to the "UP" position except for the reset enable switch, which is moved "DOWN". With the switches set in these positions, the unit is operating in mode zero (latch-on at preset, manual reset to zero). The input is set for sinking type inputs, high frequency, and high bias operation.

CONNECTIONS & CONFIGURATION SWITCH SET-UPS FOR VARIOUS SENSOR OUTPUTS

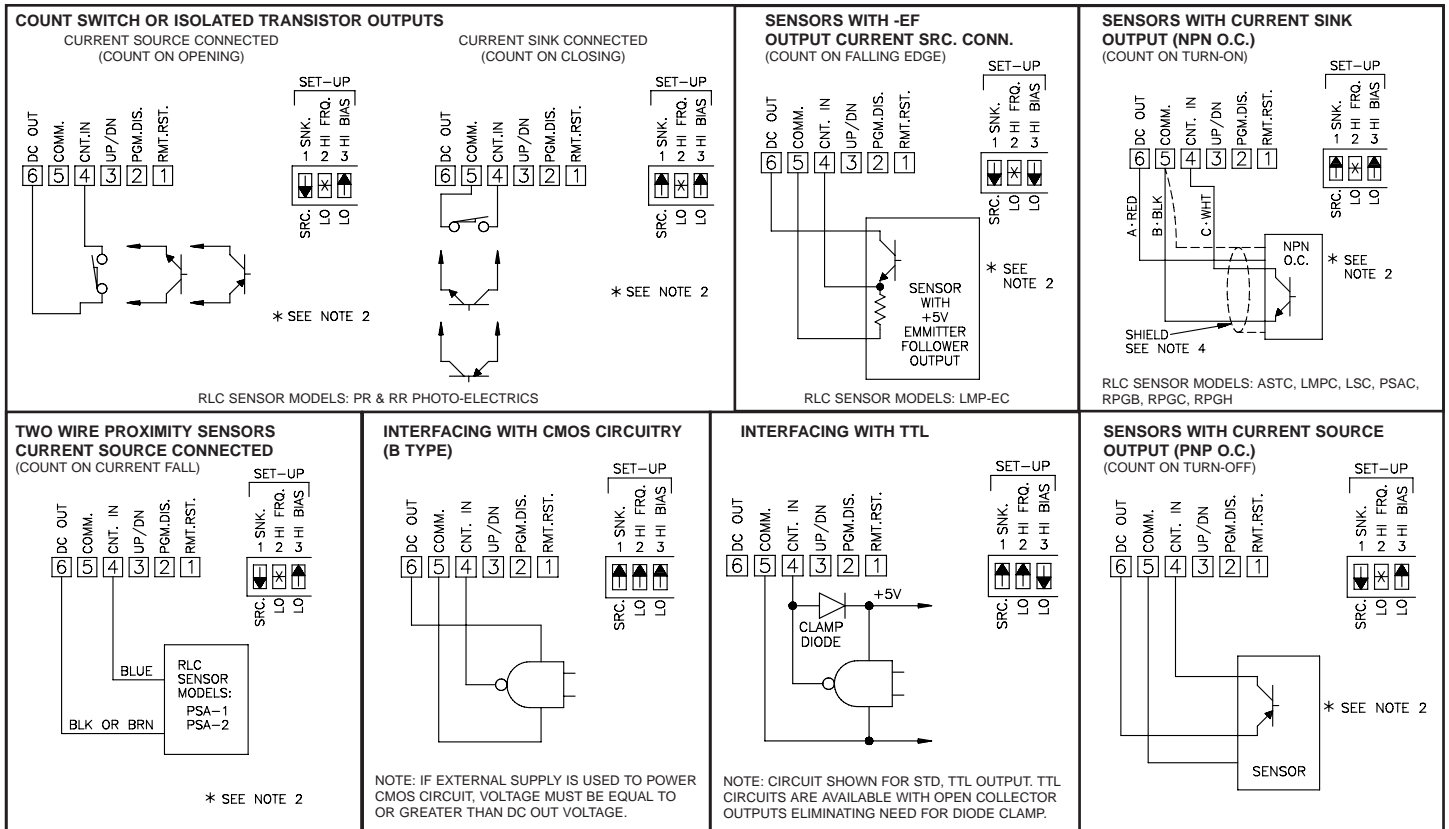

NOTES:

1. SENSOR SUPPLY VOLTAGE AND CURRENT

The +12 V sensor supply voltage on the “DC OUT” Terminal is nominal with $\pm 25\%$ variation due to line and internal load variations. All RLC sensors will accommodate this variation.

2. HI/LO FRQ. SELECTION

The “HI/LO FRQ.” Selection switch must be set on “LO FRQ.” when switch contacts are used to generate count input signals. The “LO FRQ.” mode also provides very high immunity against electrical noise pickup. It is recommended that this mode also be used, whenever possible, with

electronic sensor outputs. The “LO FRQ.” mode can be used with any type of sensor output, provided count pulse widths never decrease below 5 msec, and the count rate does not exceed 100 cps.

3. V_{IL} and V_{IH} levels given are nominal values $\pm 10\%$ when counter voltage on “DC OUT” Terminal is +12 VDC. These nominal values vary in proportion to the variations in “DC OUT” Terminal voltage, caused by line voltage and load changes.

4. When shielded cable is used, the shield should be connected to “COMM.” at the counter and left unconnected at sensor end.

INSTALLATION ENVIRONMENT

The unit should be installed in a location that does not exceed the maximum operating temperature and provides good air circulation. Placing the unit near devices that generate excessive heat should be avoided.

Continuous exposure to direct sunlight may accelerate the aging process of the bezel. The bezel should be cleaned only with a soft cloth and neutral soap product. Do NOT use solvents.

Do not use tools of any kind (screwdrivers, pens, pencils, etc.) to operate the keypad of the unit.

INSTALLATION

The Lynx Counters meet NEMA 4X/IP65 requirements for indoor use, when properly installed. These units are intended to be mounted into an enclosed panel with a gasket to provide a water-tight seal. One mounting clip and two screws with tinnerman nuts are provided for easy installation. Consideration should be given to the thickness of the panel. Too thin of a panel may distort and not provide a water-tight seal. (Recommended minimum panel thickness is 0.125" [3.18 mm].)

After the panel cut-out has been completed and deburred, carefully slide the panel gasket over the rear of the counter body to the back of the bezel. Insert the unit into the panel. As depicted in the drawing, install the two tinnerman nuts and two self-tapping screws onto the mounting clip. To install the mounting clip; hold the mounting clip with both hands so that the top corners rest on the index finger of each hand and the bottom corners rest on the middle finger of each hand. While doing this, place the thumb of each hand over the mounting screws. By pressing on the screws, flex the clip enough to slide it over the back end of the Lynx case until the clip snaps into the groove of the bezel. Tighten the two mounting screws.

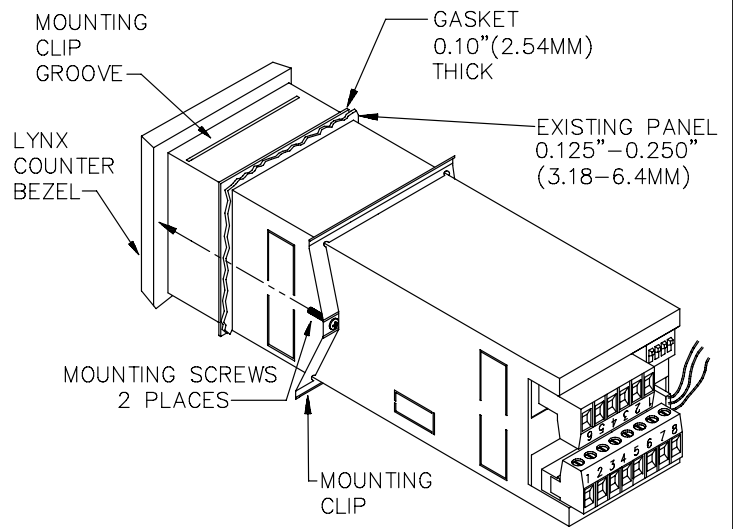

Caution: Only minimum pressure is required to seal the panel. Do **NOT** overtighten mounting screws.

CALCULATING THE PRESCALER (Dual Preset Only)

The LYNX is factory set to provide 1 count on the display for each pulse that is input to the unit. In many applications, there will not be a one to one correspondence between input pulses and display units. In these applications it will be necessary for the LYNX to scale or multiply the input pulses by a prescaler to achieve the proper display units (feet, meters, gallons, widgets, etc.).

The "Prescale", denoted as "K", is simply the total amount of scaling required. It is obtained by dividing the "Display Units" by the "Number of Pulses" as shown in the Formula below.

$$K = \text{Display Units/Number of Pulses}$$

WHERE:

DISPLAY UNITS - The number of units (revolutions, feet, 10ths of feet, meters, etc.) that would be acquired after the "Number of Pulses" has occurred.

NUMBER OF PULSES - The number of pulses required to achieve the number of "Display Units".

APPLICATION FOR DUAL LEVEL PRESET LYNX COUNTER

CARPET ROLL MEASURING & CUTTING OPERATION

This application requires the control of a motor which winds carpet onto a roll. An early warning signal is required to slow the motor 10 yards before it is to be stopped. The roll length setting should be protected against unauthorized changes and the system must be restarted from a remote location.

A dual preset LYNX counter is used to satisfy all of the above requirements. The measurement of the carpet is done by using a double wheeled version of the LSC sensor. The LSCDY20F was chosen for its 10 pulses per yard output and its durable polyurethane wheels. As the carpet is wound onto the roll, the LYNX starts counting down from its preset value of 300 yards. With a prescale value of 0.10000, the counter decrements once for every 10 pulses and indicates the number of whole yards remaining. Relay 1 turns on when the counter reaches 10, signaling the motor controller to start the slowdown process. Relay 2 turns on when the counter reaches "0", stopping the motor completely. The operator manually cuts the carpet and removes the full roll, replacing it with an empty one. The "REMOTE RESET" button and the "MOTOR START" button are pushed to start the sequence over again. Any roll length can be programmed into Preset 2 without changing Preset 1. Preset 1 will always turn on 10 yards from the end of the roll.

The following is a list of the DIP switch settings and terminal connections to meet the process requirements.

Set-Up DIP Switches	Mode DIP Switches
S1 SNK	S5 Down
S2 HI FRQ	S6 Up
S3 HI BIAS	S7 Up
S4 DIS RST	S8 Up
	S9 Up (enable)

TBA Connections

Terminal 1 (REM.RST)	Pushbutton switch
Terminal 2 (PGM.DIS)	Keyswitch
Terminal 3 (UP/DN)	Terminal 5 (COMM.)
Terminal 4 (CNT.IN)	Output of LSC
Terminal 5 (COMM.)	Common of LSC
Terminal 6 (DC OUT)	+12V of LSC

TBB Connections

Terminal 1 & 2	Primary Power
Terminal 4 & 5 (Relay 1)	Slow motor
Terminal 7 & 8 (Relay 2)	Stop motor
Terminal 3 & 6	Not Used

Front Panel Programming

Preset 1	10
Preset 2	300
Prescale	0.10000

After programming is complete, activating the key switch connects Program Disable, "PGM.DIS." to "COMM." and prevents accidental changes to programmed values. "REMOTE RESET" is accomplished by connecting the contacts of a pushbutton switch to the "REM.RST." and "COMM." terminals of the LYNX.

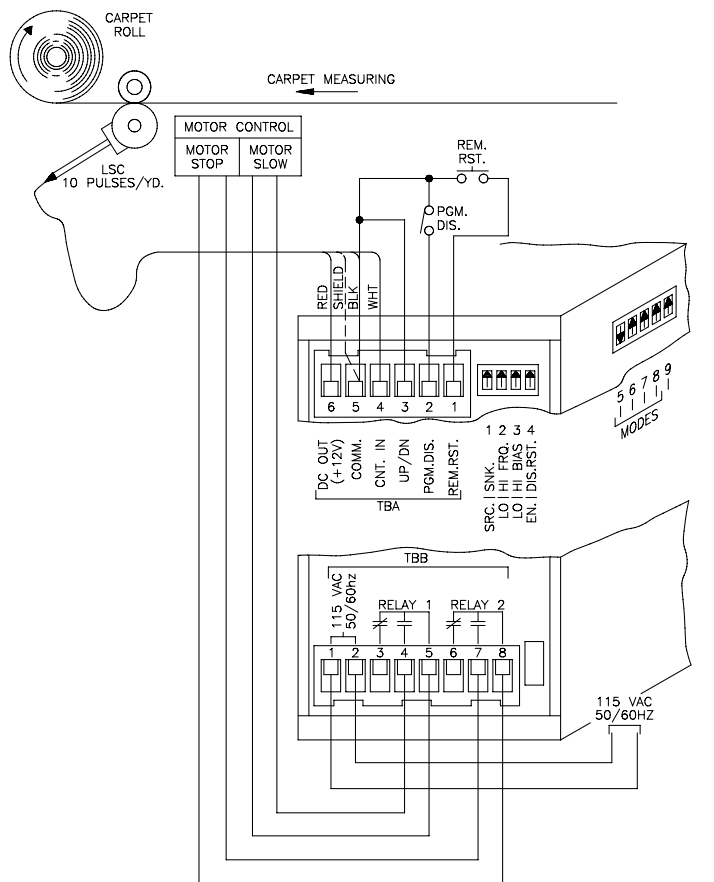

TROUBLESHOOTING

For further technical assistance, contact technical support at the appropriate company numbers listed.

ORDERING INFORMATION

MODEL NO.	DESCRIPTION	PART NUMBERS FOR AVAILABLE SUPPLY VOLTAGES			
		12 VDC	24 VDC	230 VAC	115 VAC
LNXC1	Lynx Single Preset Counter	LNXC1020	LNXC1030	LNXC1010	LNXC1000
LNXC2	Lynx Dual Preset Counter	LNXC2020	LNXC2030	LNXC2010	LNXC2000
*LNXC	Lynx Contact Input Counter	LNXC020	LNXC030	LNXC010	LNXC000

For more information on Pricing, Enclosures & Panel Mount Kits, refer to the RLC Catalog or contact your local RLC distributor

* For complete details on this version of the Lynx counter, refer to Bulletin No. LNXCC.