

## MODEL LNXCC - LYNX CONTACT INPUT COUNTER

- SINGLE PRESET
- 0.3" (7.6 mm) HIGH, 6 DIGIT DISPLAY
- NON-VOLATILE MEMORY (E<sup>2</sup>PROM)
- DISPLAY SCROLLING
- FORM (C) RELAY OUTPUT
- SOLID-STATE CURRENT SINKING OUTPUT
- PROGRAMMABLE TIMED OUTPUT
- REMOTE RESET CAPABILITY
- SIMPLIFIED FRONT PANEL PROGRAMMING
- ABILITY TO LOCK OUT FRONT PANEL FUNCTIONS
- ON-LINE SELF-TEST
- AVAILABLE IN AC OR DC VERSIONS
- FRONT PANEL PROGRAMMABLE DECIMAL POINT
- SEALED FRONT PANEL CONSTRUCTION (NEMA 4X/IP65)



### DESCRIPTION

The Lynx Contact single preset counter is an economical and reliable solution to single preset level requirements. This unit has a solid-state output and a Form C relay output. It can accept inputs from switch contact closures, NPN Open Collector output sensors, or most any other current sinking output sensor sold by RLC. It also features a full compliment of control inputs, programmable timed output, non-volatile memory, and many other features which will satisfy most any single preset application.

The Lynx Contact Counter has two main counting actions, Reset to Zero (RTZ) and Reset to Preset (RTP). There are eight modes of operation for this unit.

All parameters are programmed through the front panel buttons. The unit has an internal non-volatile memory device which eliminates the need for battery back-up. When power is removed, this device maintains all data set-ups necessary for system operation. A Program Disable terminal is provided, which can be used to prevent accidental changes or tampering by unauthorized personnel to the preset or timed output value. The front panel reset button can also be enabled or disabled by a rear panel DIP switch. This counter also has an on-line self-test, which can be run at any time without missing counts or missing a preset value.

Power, input, and output connections are made via removable terminal blocks at the rear of the unit. DIP switches at the rear of the unit are used to set up the desired mode of operation.

The Lynx Contact counter has a sealed high impact plastic bezel which meets NEMA 4X/IP65 specifications for wash-down and/or dust, when properly installed.

### SAFETY SUMMARY

All safety related regulations, local codes and instructions that appear in the manual or on equipment must be observed to ensure personal safety and to prevent damage to either the instrument or equipment connected to it. If equipment is used in a manner not specified by the manufacturer, the protection provided by the equipment may be impaired.

Do not use this unit to directly command motors, valves, or other actuators not equipped with safeguards. To do so, can be potentially harmful to persons or equipment in the event of a fault to the unit.

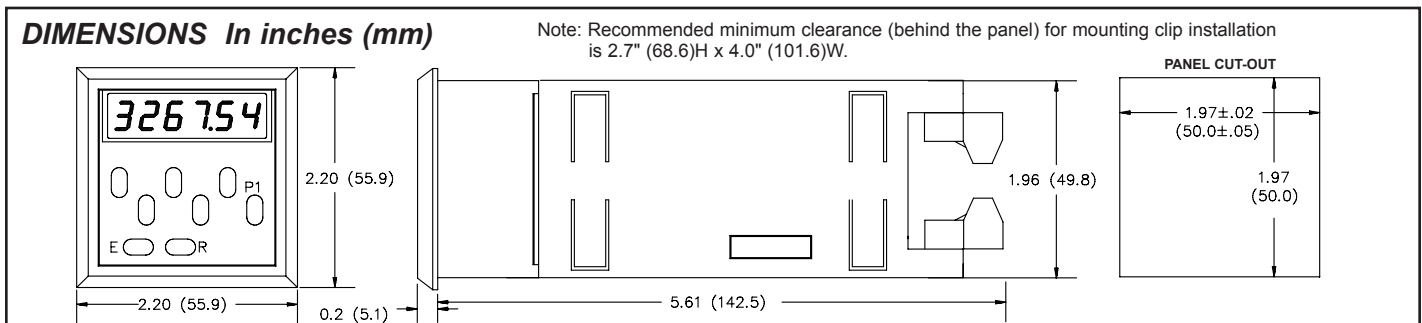
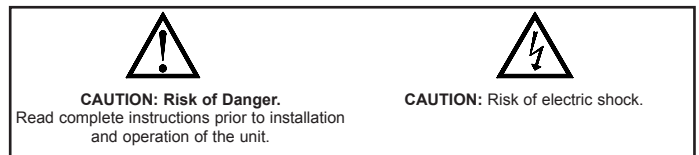

## SPECIFICATIONS

- DISPLAY:** 6-digit, 0.3" (7.6 mm) high LCD display.
- POWER REQUIREMENTS:**
  - AC Power Versions:** 115 VAC ( $\pm 10\%$ ), 50/60 Hz, 6 VA  
230 VAC ( $\pm 10\%$ ), 50/60 Hz, 6 VA
  - DC Power Versions:** 11 to 14 VDC @ 180 mA.  
21.5 to 30 VDC @ 180 mA.
- COUNT INPUT:** Switch contact closures or NPN Open Collector output sensors. (Current sinking type output sensors)  
Count threshold levels are  $V_{IL} = 0.5$  V,  $V_{IH} = 3.8$  V.  
**Current Sinking:** Unit provides 10 K $\Omega$  pull-up load for sensors with current sinking outputs. (Max. sensor current, 0.5 mA.)
- MAXIMUM COUNT RATE:** 50 Hz under all modes of operation.
- CONTROL INPUTS:** Active low ( $V_{IL} = 0.5$  V max.), internally pulled up to 5 VDC through a 10 K $\Omega$  resistor ( $I_{SNK} = 0.5$  mA).  
**Remote Reset:** Response time = 10 msec. A low will reset the unit and deactivate the output.  
**Program Disable:** A low inhibits the changing of the preset and timed output, as well as testing the output in self-test.
- OUTPUT:**
  - Solid-State:** Current sinking NPN Open Collector Transistor.  $I_{SNK} = 100$  mA max.,  $V_{OH} = 30$  VDC max.,  $V_{OL} = 1$  V @ 100 mA.
  - Relay:** Form C contacts max. rating 5 amps @ 120/240 VAC, 28 VDC (resistive load), 1/8 H.P. @ 120 VAC (inductive load). The operate time is 5 msec. nominal and the release time is 3 msec. nominal.
  - Relay Life Expectancy** - 100,000 cycles at max. rating. (As load level decreases, life expectancy increases.)
  - Programmable Timed Output:** The timed output can be programmed from 0.01 sec. to 99.99 sec.,  $\pm 0.1\% + 10$  msec. The timed output is set for 0.1 sec. at the factory.
- MEMORY RETENTION:** Non-volatile E<sup>2</sup>PROM retains all programmed information when power is removed or interrupted.  
**Power Cycles(ON/OFF):** 100,000 min.  
**Data Retention:** 10 years min.
- INPUT, POWER, AND OUTPUT CONNECTIONS:** Removable terminal blocks.

## 9. ENVIRONMENTAL CONDITIONS:

- Operating Temperature:** 0 to 50°C
- Storage Temperature:** -40 to 70°C
- Operating and Storage Humidity:** 85% max. relative humidity (non-condensing) from 0°C to 50°C.
- Altitude:** Up to 2000 meters

## 10. CERTIFICATIONS AND COMPLIANCES:

### SAFETY

- IEC 61010-1, EN 61010-1: Safety requirements for electrical equipment for measurement, control, and laboratory use, Part 1.
- IP65 Enclosure rating (Face only), IEC 529
- Type 4X Enclosure rating (Face only), UL50

### ELECTROMAGNETIC COMPATIBILITY

#### Immunity to EN 50082-2

Electrostatic discharge	EN 61000-4-2	Level 2; 4 Kv contact Level 3; 8 Kv air
Electromagnetic RF fields	EN 61000-4-3	Level 3; 10 V/m 80 MHz - 1 GHz
Fast transients (burst)	EN 61000-4-4	Level 4; 2 Kv I/O <sup>2</sup> Level 3; 2 Kv power <sup>1</sup>
RF conducted interference	EN 61000-4-6	Level 3; 10 V/rms <sup>1</sup> 150 KHz - 80 MHz

#### Emissions to EN 50081-2

RF interference	EN 55011	Enclosure class A Power mains class A
-----------------	----------	--

### Notes:

- Power lines had an external EMI line filter (RLC #LFIL0000 or equivalent) installed.
- I/O cables routed in metal conduit connected to earth ground. Refer to the EMC Installation Guidelines section of the bulletin for additional information.
- CONSTRUCTION:** Black plastic front bezel with black plastic insert. Front panel meets NEMA 4X/IP65 requirements for wash-down and dusty environments, when properly installed. Installation Category II, Pollution Degree 2. (Panel gasket, mounting clip, nut fasteners, and screws included with unit.)
- WEIGHT:** 0.8 lbs (0.36 kg).

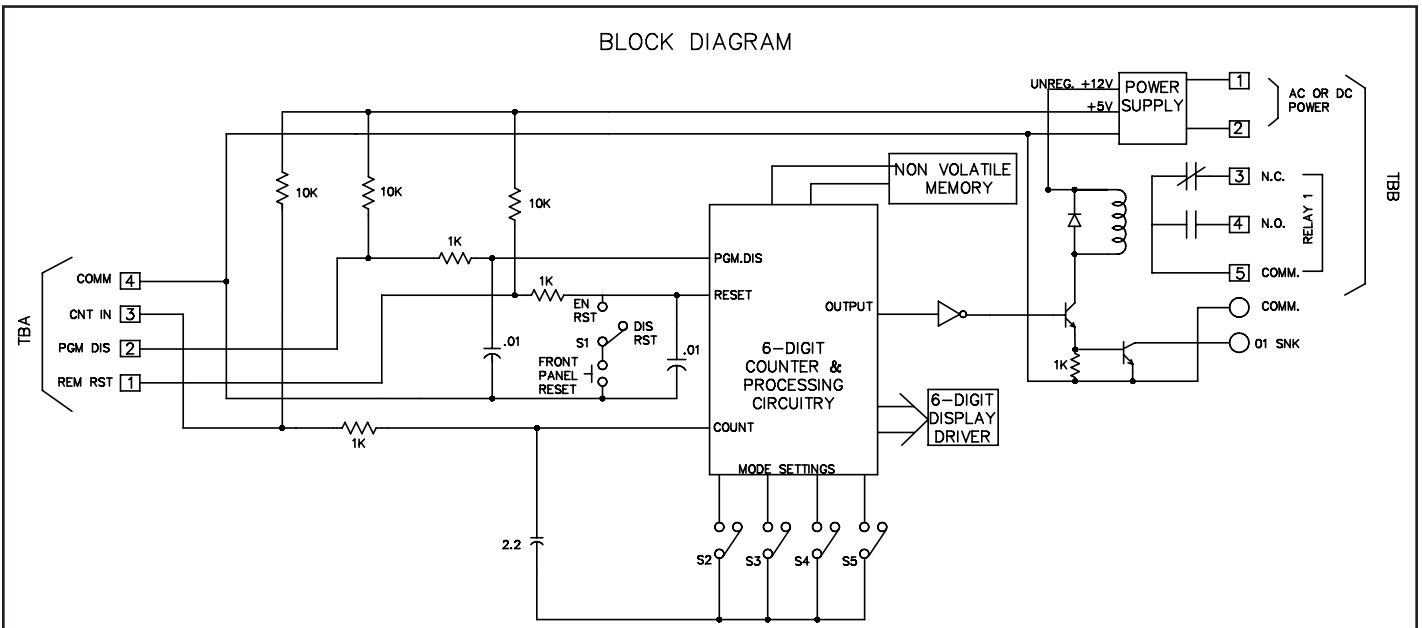

## ORDERING INFORMATION

MODEL NO.	DESCRIPTION	PART NUMBERS FOR AVAILABLE SUPPLY VOLTAGES			
		12VDC	24VDC	230VAC	115VAC
LNXC	Lynx Contact Input Counter	LNXC020	LNXC030	LNXC010	LNXC000
*LNXC1	Lynx Single Preset Counter	LNXC1020	LNXC1030	LNXC1010	LNXC1000
*LNXC2	Lynx Dual Preset Counter	LNXC2020	LNXC2030	LNXC2010	LNXC2000

For more information on Pricing, Enclosures & Panel Mount Kits refer to the RLC Catalog or contact your local RLC distributor.

\* For complete details on these versions of the Lynx counters, refer to Bulletin No. LNXC1/2.

## MODES OF OPERATION, DIP SWITCH SET-UP

Modes of operation and front panel reset enable are selected by five DIP switches located at the rear of the unit. DIP switch 1 is used to enable or disable the front panel reset button. DIP switches 2 through 5 are used to select the desired mode of operation. Mode settings of the switches are shown to the right of the text below.

Note: During automatic reset, no counts will be missed if the count rate does

not exceed the maximum count rate specified. A manual reset, either from the front panel reset (if enabled) or remote reset, overrides any condition or state of the counter and begins the cycle again.

Note: In modes four and twelve, the output may appear to be latched if the time delay is longer than the time required to count from the reset condition to the preset point.

### MODES OF OPERATION FOR THE LYNX CONTACT PRESET COUNTER

#### MODE 0 LATCH OUTPUT AT PRESET, MANUAL RESET TO ZERO

The unit counts from zero; when the preset value is reached, the output turns on and counts continue to accumulate. When a manual reset is performed, the count resets to zero and the output turns off.

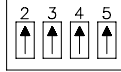

#### MODE 1 TIMED OUTPUT AT PRESET, MANUAL RESET TO ZERO

The unit counts from zero; when the preset is reached, the output turns on for the amount of time programmed and counts continue to accumulate. When a manual reset is performed, the unit resets to zero and starts the cycle again.

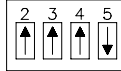

#### MODE 2 & 3 - \*

#### MODE 4 TIMED OUTPUT AT PRESET, AUTOMATIC RESET TO ZERO AT PRESET

The unit counts from zero; when the preset is reached, the output turns on for the amount of time programmed. At preset, the unit automatically resets to zero and starts the counting cycle again.

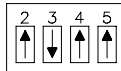

#### MODE 5 - \*

#### MODE 6 TIMED OUTPUT AT PRESET, AUTOMATIC RESET TO ZERO AFTER THE TIMED OUTPUT

The unit counts from zero; when the preset is reached, the output turns on for the amount of time programmed. At the end of the timed output, the unit automatically resets to zero and starts the cycle again.

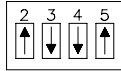

#### MODE 7 - \*

#### MODE 8 LATCH OUTPUT AT ZERO, MANUAL RESET TO PRESET

The unit counts down from preset; when zero is reached the output turns on and counts continue to accumulate. When a manual reset is performed, the unit resets to preset, the output turns off, and the cycle starts again.

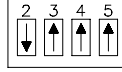

#### MODE 9 TIMED OUTPUT AT ZERO, MANUAL RESET TO PRESET

The unit counts down from preset; when zero is reached, the output turns on for the amount of time programmed and counts continue to accumulate. When a manual reset is performed, the unit resets to preset and starts the cycle again.

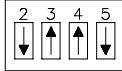

#### MODE 10 & 11 - \*

#### MODE 12 TIMED OUTPUT AT ZERO, AUTOMATIC RESET TO PRESET AT ZERO

The unit counts down from preset; when zero is reached, the output turns on for the amount of time programmed. At zero, the unit automatically resets to preset and starts the counting cycle again.

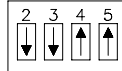

#### MODE 13 - \*

#### MODE 14 TIMED OUTPUT AT ZERO, AUTOMATIC RESET TO PRESET AFTER THE TIMED OUTPUT

The unit counts down from preset; when zero is reached, the output turns on for the amount of time programmed. At the end of the timed output, the unit automatically resets to preset and restarts the cycle.

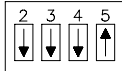

#### MODE 15 - \*

\* - These modes are not applicable.

## POWER-UP DIAGNOSTICS

Upon applying power, the Lynx contact counter performs an internal self-diagnostic test of all the stored data. If the tests do not agree, a "P" appears on the right side of the display. Normal operation of the unit will continue while the "P" is displayed. Press the "E" button to remove the "P" and check all data set-up values to be certain they are correct.

## EMC INSTALLATION GUIDELINES

Although this unit is designed with a high degree of immunity to ElectroMagnetic Interference (EMI), proper installation and wiring methods must be followed to ensure compatibility in each application. The type of the electrical noise, source or coupling method into the unit may be different for various installations. The unit becomes more immune to EMI with fewer I/O connections. Cable length, routing and shield termination are very important and can mean the difference between a successful or a troublesome installation. Listed below are some EMC guidelines for successful installation in an industrial environment.

- Use shielded (screened) cables for all Signal and Control inputs. The shield (screen) pigtail connection should be made as short as possible. The connection point for the shield depends somewhat upon the application. Listed below are the recommended methods of connecting the shield, in order of their effectiveness.
  - Connect the shield only at the panel where the unit is mounted to earth ground (protective earth).
  - Connect the shield to earth ground at both ends of the cable, usually when the noise source frequency is above 1 MHz.
  - Connect the shield to common of the unit and leave the other end of the shield unconnected and insulated from earth ground.
- Never run Signal or Control cables in the same conduit or raceway with AC power lines, conductors feeding motors, solenoids, SCR controls, and heaters, etc. The cables should be run in metal conduit that is properly grounded. This is especially useful in applications where cable runs are long and portable two-way radios are used in close proximity or if the installation is near a commercial radio transmitter.

- Signal or Control cables within an enclosure should be routed as far away as possible from contactors, control relays, transformers, and other noisy components.
- In extremely high EMI environments, the use of external EMI suppression devices, such as ferrite suppression cores, is effective. Install them on Signal and Control cables as close to the unit as possible. Loop the cable through the core several times or use multiple cores on each cable for additional protection. Install line filters on the power input cable to the unit to suppress power line interference. Install them near the power entry point of the enclosure. The following EMI suppression devices (or equivalent) are recommended:

Ferrite Suppression Cores for signal and control cables:

Fair-Rite # 0443167251 (RLC #FCOR0000)

TDK # ZCAT3035-1330A

Steward #28B2029-0A0

Line Filters for input power cables:

Schaffner # FN610-1/07 (RLC #LFIL0000)

Schaffner # FN670-1.8/07

Corcom #1VR3

Note: Reference manufacturer's instructions when installing a line filter.

- Long cable runs are more susceptible to EMI pickup than short cable runs. Therefore, keep cable runs as short as possible.
- Switching of inductive loads produces high EMI. Use of snubbers across inductive loads suppresses EMI.

Snubbers:

RLC #SNUB0000

## WIRING CONNECTIONS

All conductors should meet voltage and current ratings for each terminal. Also cabling should conform to appropriate standards of good installation, local codes and regulations. It is recommended that power supplied to the unit (AC or DC) be protected by a fuse or circuit breaker.

When wiring the unit, remove the terminal block and use the numbers on the label to identify the position number with the proper function. Strip the wire, leaving approximately 1/4" (6 mm) bare wire exposed (*stranded wires should be tinned with solder*). Insert the wire into the terminal and tighten down the screw until the wire is clamped tightly. Each terminal can accept up to one #14 AWG, two #18 AWG or four #20 AWG wire(s). After the terminal block is wired, install it into the proper location on the PC board. Wire each terminal block in this manner.

**Caution:** Terminal blocks should **NOT** be removed with power applied to the unit.

## INPUT CONNECTIONS

Input connections are made on terminal block TBA, refer to numbers on the label to identify the position number with the proper function. The use of shielded cable is recommended. Follow the EMC Installation Guidelines for shield connection.

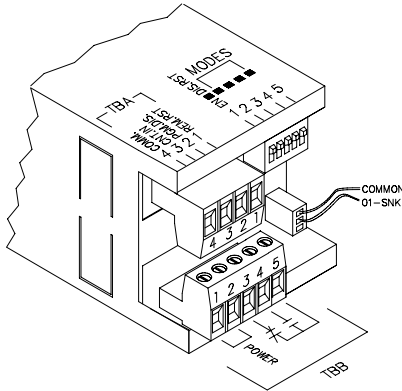

**Terminal 1** - "REM.RST." (remote reset) When connected to common a manual reset is performed. The output turns off (*if activated*) and the count display is reset. As long as this terminal is low, the unit is held at reset.

**Terminal 2** - "PGM.DIS." (program disable) When this terminal is not connected to common, the following values can be programmed using the front panel buttons:

- Preset Value
- Decimal Point Position
- Timed Output Value

Outputs can also be tested during self-test under this condition (*See "Self-Test" description for further details*). When connected to common, changing these values and testing the output is no longer possible.

**Terminal 3** - "CNT.IN" (count input) When the signal is pulled low, a count will be registered. (*See Count Input and Count Rates under the Specifications Section.*)

**Terminal 4** - "COMM." (common) This is the common line to which the sensor and other input commons are connected. (*Do NOT connect relay common or solid-state output common to this point.*)

## POWER & OUTPUT CONNECTIONS

The input power and relay output connections are made to the bottom terminal block (TBB), and the solid-state output is connected to the polarized three-pin connector.

### Relay Connections

To prolong contact life and suppress electrical noise interference due to the switching of inductive loads, it is good installation practice to install a snubber across the contactor. Follow the manufacturer's instructions for installation.

*Note: Snubber leakage current can cause some electro-mechanical devices to be held ON.*

## AC POWER WIRING

Primary AC power is connected to terminals 1 and 2 of TBB (marked VAC 50/60 Hz). To reduce the chance of noise spikes entering the AC line and affecting the unit, the power should be relatively "clean" and within the 10% variation limit. Drawing power from heavily loaded circuits, or from circuits that also power loads that cycle on and off (*contactors, relays, motors, machinery, etc.*), should be avoided.

## DC POWER WIRING

The DC power is connected to terminals 1 and 2 of TBB. The DC plus(+) power is connected to TBB 1 and the minus(-) is connected to TBB 2.

## OUTPUT WIRING

Terminals 3, 4, and 5 are used to connect to the output relay. (*See Block Diagram*)

The solid-state output connector has two wires on top of the connector housing.

**Yellow wire** - Solid-state output 1 (*labeled 01 SNK.*) internally connects to an NPN Open Collector transistor.

**Black wire** - common for the solid-state output. This terminal should **NOT** be used as the common for the input or control terminals.

## FRONT PANEL FUNCTION DESCRIPTION

This unit employs eight front panel buttons for control and data entry. The button functions are as described below:

**RESET "R":** Resets the counter to either zero or preset, depending on the mode of operation selected. For this button to operate, the enable/disable reset switch at the rear of the unit must be set to the enable (EN.) position. Also it is used in conjunction with the preset button, to view and change the timed output value. When reset is activated, all processes are stopped or interrupted (*i.e. output turns off, display is reset, etc.*). This is the case under any mode of operation, in any data entry mode.

**PRESET "P1":** The preset value is displayed when the P1 button is pressed, and the Preset Value mode is accessed (*See Program Preset Value*). The value remains displayed for approximately 10 seconds after release of the button. The preset button is also used, in conjunction with the reset button, to view and change the timed output value (*See Program Timed Output Value section.*)

**ENTER "E":** Used when programming the Preset Value or the Timed Output Value. After the desired value is obtained on the display, pressing the "E" button enters the value into the unit's internal memory and takes effect immediately. Also the "E" button can be used to exit self-test.

## DISPLAY SCROLLING

To set the display to scroll, press and hold the "E" button and then press the left-most button on the front panel. To stop the scrolling, repeat the above step.

### DISPLAY SCROLLING SEQUENCE

**Single Preset**  
P1  
Value of P1  
Count Value

## PROGRAM PRESET VALUE \*

The factory default value is set to 500. To enter a different value, the operator must enter the Preset Value Programming Mode by performing the following steps.

*Note: During the displaying, changing, and entering of a new preset value, all functions of the unit are operational (i.e. counting, resetting, outputs activating, etc.)*

**FIRST:** Press "P1". This displays the preset value, which remains displayed for approximately 10 seconds after release of the last button pushed. At this time, the preset display mode can be exited, without change, by pressing the "E" button.

**SECOND:** Once the preset value is displayed, a specific digit can be incremented by pressing the button directly beneath that digit. Pressing and holding the button down continuously scrolls the digit from 0 through 9, then back to 0 again. When the desired value for that digit is reached, release the button. Repeat this step until the desired preset value is obtained.

**THIRD:** Press the "E" button to enter the value into the unit's memory. **As Soon As** the "E" button is pressed, the new preset value takes effect. If the "E" button is not pressed within 10 seconds, the unit returns to normal display operation with the previous value retained.

\* To enter any new data into the Lynx, the "PGM.DIS." terminal must be deactivated (open or at +5 VDC maximum).

## PROGRAM TIMED OUTPUT VALUE \*

The factory default Timed Output Value is 0.10 seconds, but can be programmed from 0.01 to 99.99 seconds. To enter a different value, the operator must enter the Timed Output Value Programming Mode by performing the following steps.

*Note: During the displaying, changing, and entering of a new timed output value, all functions of the unit are operational (i.e. counting, resetting, outputs activating, etc.)*

**FIRST:** Set S1 Reset EN./DIS. switch to the Down position (*Enable*).

**SECOND:** Press and hold the “P1” button and then press the “R” button. The timed output value is displayed and remains displayed for approximately 10 seconds after release of the last button pushed. At this time, the timed output display mode can be exited, without change, by pressing the “E” button.

**THIRD:** Once the timed output value is displayed, a specific digit can be incremented by pressing the button directly beneath that digit. Pressing and holding the button down continuously scrolls the digit from 0 through 9, then back to 0 again. When the desired value for that digit is reached, release the button. Repeat this step until the desired timed output value is obtained.

**FOURTH:** Press the “E” button to enter the value into the unit’s memory. **As Soon As** the “E” button is pressed, the new timed output value takes effect. If the “E” button is not pressed within 10 seconds, the unit returns to normal display operation with the previous value retained.

## PROGRAM DECIMAL POINT \*

The Lynx has the capability of displaying a decimal point in one of five positions. The decimal point selection can be done at any time without missing counts or preset outputs. The factory default for the Decimal Point Position is off. To turn a decimal point on, the operator must enter the Decimal Point Position Programming Mode by performing the following steps.

*Note: During the displaying, changing, and entering of a new decimal point value, all functions of the unit are operational (i.e. counting, resetting, outputs activating, etc.)*

**FIRST:** Press and release the left-most digit button on the front panel. This places the Lynx in the decimal point select mode.

**SECOND:** Press the digit button which corresponds to the desired decimal point position. A decimal point will appear to the right of the digit selected. If the right-most digit button (P1) is selected, the decimal point is turned off.

**THIRD:** At the time the decimal point is selected, the unit automatically returns to normal operation. No further action is required by the operator.

\* To enter any new data into the Lynx, the “PGM.DIS.” terminal must be deactivated (open or at +5 VDC maximum).

## SELF-TEST

The self-test feature can be activated without affecting the count, missing a preset point, affecting the timed output durations, or interfering with control functions. This test verifies that all digits operate. Also, the DIP switch settings and the relay output can be tested.

If the output is not tested, the state of the output remains the same as it was prior to self-test. If the output is tested in self-test, the output will be off after exiting self-test.

Rapid advance of the self-test routine can be done by pressing and releasing any of the front panel buttons except for the “R” button. (*Pressing “R” at any time, except when entering the timed output mode, resets the unit.*)

To enter self-test, press the two left-hand digit buttons (*on the front panel*) simultaneously. At this time, the display will cycle all the digits on the display each for about half a second and in the sequence shown below.

### DIGITS CYCLED ON THE DISPLAY

000000  
111111  
222222  
333333  
444444  
555555  
666666  
777777  
888888  
999999  
BLANK DISPLAY  
101010  
121212  
323232  
343434  
545454  
565656  
767676  
787878  
989898

The next portion of self-test displays a group of four ones and zeros. The first three digits always appear as zeros. The fourth digit represents program disable (PGM.DIS). A zero represents a high at this terminal and a one represents a low. The second set of digits are the settings of the mode select switches. This pattern directly corresponds to the number representing the mode of operation. If the switches are changed while at this point in the self-test, the settings can be seen to change. These changes do not affect counter operation immediately, but any changes will take effect when self-test is exited. When the switch is “DOWN”, the digit shows a one. When the switch is “UP”, the digit shows a zero.

During the time the mode switch settings are displayed, the output can be tested. To activate the output, press the “P1” button. If no testing of the output is required, press the “E” button until the unit exits self-test (*the unit returns to normal display mode*). Also, if no activity occurs on the switches or the front panel button within 18 seconds after the unit pauses at the mode switch display, the unit automatically exits self-test.

*Note: The “PGM.DIS.” terminal must not be connected to common for the outputs to be activated during self-test.*

**CAUTION:** The operator should use care when testing the outputs, so as not to cause any undesirable or hazardous conditions in the system.

## INITIAL POWER-UP & FACTORY SETTINGS

When the unit is shipped from the factory, the values and the following modes are set as shown.

Preset 1 = 500  
Count Value = 0  
Timed Output Value(s) = 0.10 second

## DIP SWITCH SETTINGS

All switches are set to the “UP” position except for the reset enable switch, which is “DOWN”. With the switches set in these positions, the unit is operating in mode zero (*latch-on at preset, manual reset to zero*).

## INSTALLATION ENVIRONMENT

The unit should be installed in a location that does not exceed the maximum operating temperature and provides good air circulation. Placing the unit near devices that generate excessive heat should be avoided.

Continuous exposure to direct sunlight may accelerate the aging process of the bezel. The bezel should be cleaned only with a soft cloth and neutral soap product. Do NOT use solvents.

Do not use tools of any kind (screwdrivers, pens, pencils, etc.) to operate the keypad of the unit.

## INSTALLATION

The Lynx Counters meet NEMA 4X/IP65 requirements for indoor use, when properly installed. These units are intended to be mounted into an enclosed panel with a gasket to provide a water-tight seal.

One mounting clip and two screws with nuts are provided for easy installation. Consideration should be given to the thickness of the panel. A panel that is too thin, may distort and not provide a water-tight seal. (Recommended minimum panel thickness is 0.125" [3.18 mm].)

After the panel cut-out has been completed and deburred, carefully slide the panel gasket over the rear of the counter body to the back of the bezel. Insert the unit into the panel. As depicted in the drawing, install the two tinnerman nuts and two self-tapping screws onto the mounting clip. To install the mounting clip; hold the mounting clip with both hands so that the top corners rest on the index finger of each hand and the bottom corners rest on the middle finger of each hand. While doing this, place the thumb of each hand over the mounting screws. By pressing on the screws, flex the clip enough to slide it over the back end of the Lynx case until the clip snaps into the groove of the bezel. Tighten the two mounting screws.

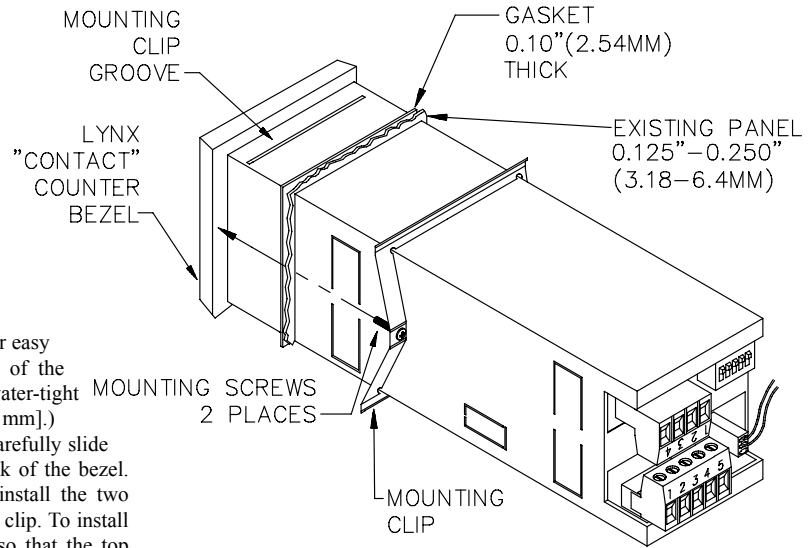

*Caution: Only minimum pressure is required to seal the panel. Do **NOT** overtighten mounting screws.*

## TROUBLESHOOTING

For further technical assistance, contact technical support at the appropriate company numbers listed.

# APPLICATION FOR LYNX CONTACT COUNTER

## COUNTING AND CUTTING BUSINESS FORMS

This application requires that business forms be counted as they are cut to length and then packed in boxes of 100. To assure the proper number of forms are packed in each box, a burst of air is applied to the underside of the last form in each batch causing the form to move slightly out of line with respect to the other forms. The air jet duration required varies for different size forms and should be adjustable. When packing these forms, the packer uses this offset form as a marker to indicate the last form to be packed in each box. The knife controller is used to generate the necessary contact closure pulses.

The system operation is as follows: When the forms machine is running, the knife control circuit signals the knife at the appropriate time to cut each form to length. When this happens, the output of the knife causes the LYNX display to increment. When the counter reaches the desired preset value, the output fires for the predetermined time period, causing the air jet to offset one of the forms. The LYNX immediately resets to zero and is ready for the next cycle.

The following is a list of the DIP switch settings and terminal connections to meet the process requirements.

FRONT PANEL PROGRAMMING		MODE DIP SWITCHES	
preset 1	100	S1	Up (Disable)
Timed output	0.50 seconds	S2	Up (Mode 4)
		S3	Down
		S4	Up
		S5	Up

### TBA CONNECTIONS

Terminal 1 (REM.RST)	Unconnected
Terminal 2 (PGM.DIS)	Keyswitch
Terminal 3 (CNT.IN)	Knife Controller Output
Terminal 4 (COMM.)	Knife Controller Output

### TBB CONNECTIONS

Terminal 1 & 2	Primary Power
Terminal 4 & 5 (Output)	Air jet control
Terminal 3	Not used

The preset number and output time duration are locked from further entry when the key switch connects the Program Disable ("PGM. DIS.") terminal to the "COMM." of the LYNX Contact Counter.

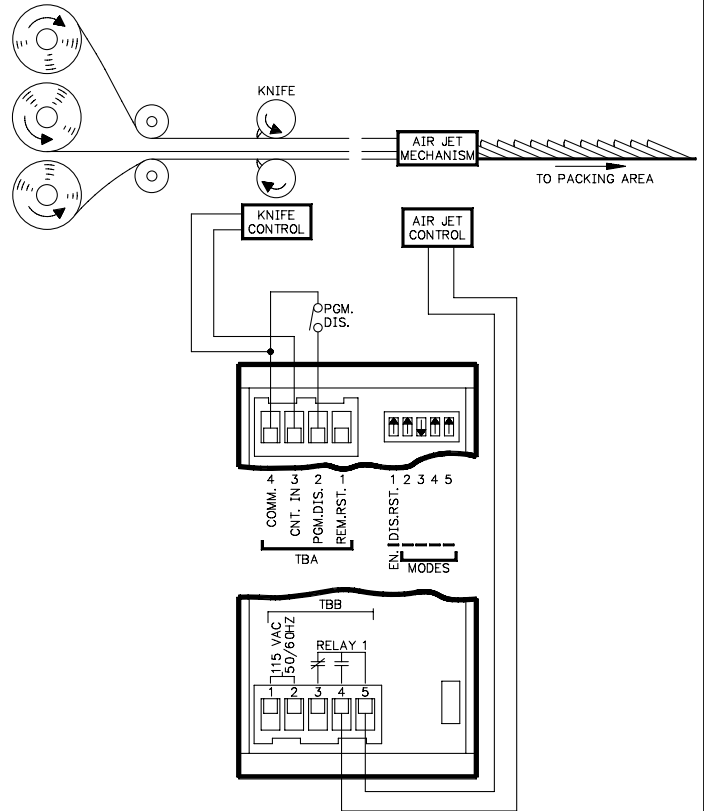

### **LIMITED WARRANTY**

The Company warrants the products it manufactures against defects in materials and workmanship for a period limited to two years from the date of shipment, provided the products have been stored, handled, installed, and used under proper conditions. The Company's liability under this limited warranty shall extend only to the repair or replacement of a defective product, at The Company's option. The Company disclaims all liability for any affirmation, promise or representation with respect to the products.

The customer agrees to hold Red Lion Controls harmless from, defend, and indemnify RLC against damages, claims, and expenses arising out of subsequent sales of RLC products or products containing components manufactured by RLC and based upon personal injuries, deaths, property damage, lost profits, and other matters which Buyer, its employees, or sub-contractors are or may be to any extent liable, including without limitation penalties imposed by the Consumer Product Safety Act (P.L. 92-573) and liability imposed upon any person pursuant to the Magnuson-Moss Warranty Act (P.L. 93-637), as now in effect or as amended hereafter.

No warranties expressed or implied are created with respect to The Company's products except those expressly contained herein. The Customer acknowledges the disclaimers and limitations contained herein and relies on no other warranties or affirmations.

Red Lion Controls  
20 Willow Springs Circle  
York PA 17402  
Tel +1 (717) 767-6511  
Fax +1 (717) 764-0839

Red Lion Controls BV  
Basicweg 11b  
NL - 3821 BR Amersfoort  
Tel +31 (0) 334 723 225  
Fax +31 (0) 334 893 793

Red Lion Controls AP  
31, Kaki Bukit Road 3,  
#06-04/05 TechLink  
Singapore 417818  
Tel +65 6744-6613  
Fax +65 6743-3360