

MODEL LPAX- 6 DIGIT LARGE PAX DISPLAY FOR DIGITAL INPUTS





- LARGE LED DISPLAY READABLE TO 70 FEET
- VARIOUS DIGITAL INPUT MODULES;
 COUNT AND RATE INPUT
 CLOCK/TIMER
 SERIAL SLAVE
- ALARMS, ANALOG OUTPUT, AND COMMUNICATION
- PROGRAMMABLE USER INPUTS
- PROGRAMMABLE FUNCTION KEYS
- UNIVERSAL AC/DC POWERED MODELS
- PC SOFTWARE FOR METER CONFIGURATION
- NEMA 4/IP65

GENERAL DESCRIPTION

The LPAX Display is a versatile display that can increase productivity by offering the plant floor or production area a large visual display of their current status. Whether your measurement is rate, count, or time, the LPAX can satisfy your requirement. These LPAX displays accept various digital inputs through the use of input modules (MPAX) which allow the unit to adapt to most any application. The MPAX Modules offer the same features as our highly successful PAX Series Panel Meters. Additional plug-in option cards can add alarms, analog output, and communication/bus capabilities, making the LPAX a truly Intelligent Panel Meter.

SAFETY SUMMARY

All safety regulations, local codes and instructions that appear in this and corresponding literature, or on equipment, must be observed to ensure personal safety and to prevent damage to either the instrument or equipment connected to it. If equipment is used in a manner not specified by the manufacturer, the protection provided by the equipment may be impaired.

  The protective conductor terminal is bonded to conductive parts of the equipment for safety purposes and must be connected to an external protective earthing system.



CAUTION: Risk of Danger.
Read complete instructions prior to installation and operation of the unit.



CAUTION: Risk of electric shock.

SPECIFICATIONS

Additional specifications, wiring, programming, and information for the individual MPAX models are contained in the corresponding standard PAX literature. This PAX literature is shipped with the ordered MPAX model.

1. **DISPLAY:** 1.5" (38 mm) Red LED
 6-Digit (LPAX0600): (-99999 to 999999)
 6-Digit (LPAXCK00): (0 to 999999)
2. **POWER REQUIREMENTS:**
 AC Modules: 85 to 250 VAC, 50/60 Hz, 18 VA
 DC Modules: 11 to 36 VDC or 24 VAC ±10%, 50/60 Hz, 14 W
3. **INPUT:** Accepts digital input modules, see "Selecting Your Display Components and Option Cards."
4. **ANNUNCIATORS:**
 LPAX0600: A, B, C, SP1, SP2, SP3, and SP4
 LPAXCK00: TMR, CNT, DAT, SP1, SP2, SP3, and SP4
5. **KEYPAD:** Five tactile membrane switches integrated into the front panel
6. **CERTIFICATIONS AND COMPLIANCES:**

SAFETY

UL Recognized Component, File #E179259, UL61010A-1, CSA 22.2 No. 1010-1 Recognized to US and Canadian requirements under the Component Recognition Program of Underwriters Laboratories, Inc.
 UL Listed, File # E137808, UL508, CSA C22.2 No. 14-M95 LISTED by Und. Lab. Inc. to U.S and Canadian safety standards
 Type 4 Enclosure rating (Face Only), UL50
 IECCE CB Scheme Test Certificate # US/8843/UL
 CB Scheme Test Report # 04ME11209-20041018
 Issued by Underwriters Laboratories, Inc.
 IEC 61010-1, EN 61010-1: Safety requirements for electrical equipment for measurement, control, and laboratory use, Part 1.
 IP65 Enclosure rating (Face only), IEC 529

ELECTROMAGNETIC COMPATIBILITY

EMC specifications determined by the MPAX module.

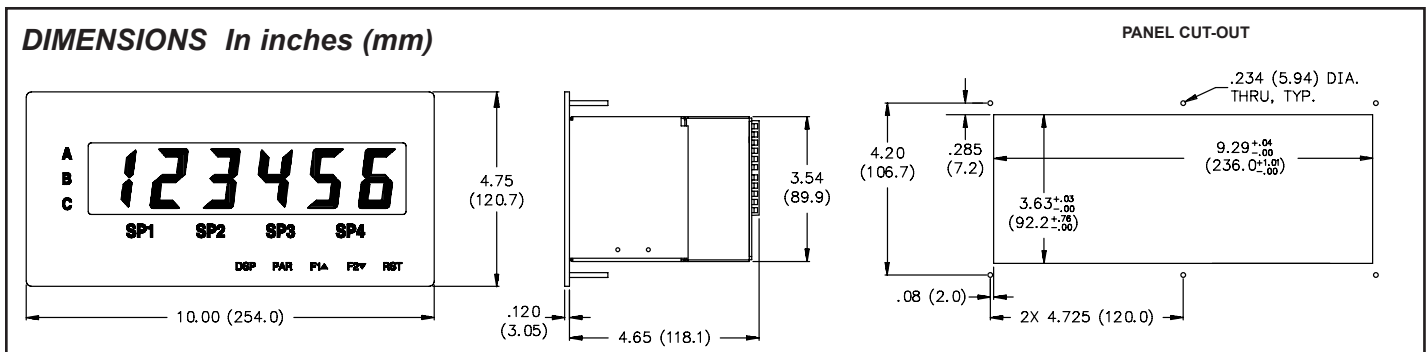

7. ENVIRONMENTAL CONDITIONS:

Operating Temperature Range: Determined by the MPAX module
 Storage Temperature Range: -40 to 60°C
 Operating and Storage Humidity: 0 to 85% max. RH (non-condensing)
 Altitude: Up to 2000 meters

8. MOUNTING REQUIREMENTS:

Max. panel thickness is 0.375" (9.5 mm)
 Min. panel thickness for NEMA 4/IP65 sealing is 0.060" (1.57 mm)

9. MODULE INSTALLATION:

24-pin shrouded connector on LPAX engages connector on MPAX module upon installation. Shroud ensures proper alignment by providing a lead-in for the module connector.

10. CONNECTIONS: All wiring connections are made to the MPAX module via high compression cage-clamp terminal blocks. Wiring instructions are provided with the MPAX module.



CAUTION: DISCONNECT ALL POWER BEFORE INSTALLING OR REMOVING MODULE

11. CONSTRUCTION: Steel front panel, enclosure, and rear cover with textured black polyurethane paint for scratch and corrosion resistance protection. Sealed front panel meets NEMA 4/IP65 specifications for indoor use when properly installed. Installation Category II, Pollution Degree 2. Panel gasket and keps nuts included.

12. WEIGHT: 2.7 lbs (1.2 kg) (*less module*)

About the MPAX Input Modules

The MPAX Module serves as the input to the LPAX Display. There are several different modules to cover a variety of inputs. The MPAX module provides input scaling which allows the LPAX to display most any engineering unit. Once the MPAX is inserted into the LPAX, the unit has the same functions and capabilities of our PAX Series Intelligent Panel Meters. A full set of PAX programming instructions will be included with the MPAX module.

Note: The MPAX provides the operating power for the LPAX, therefore you must select either the AC or DC MPAX corresponding with your application and available power.

Selecting Your Display Components and Option Cards

To build a complete display unit, you will need an LPAX and an MPAX Input Module. The LPAX is only a display and will not operate without an MPAX module. Please use the following chart to identify the appropriate MPAX module (including supply power) and LPAX Display that will satisfy your application.

SIGNAL TYPE	MPAX MODULES*		LPAX DISPLAYS	OPTIONAL PLUG-IN CARD COMPATABILITY			
	85-250 VAC	11 to 36 VDC / 24 VAC		SETPOINT	COMMS	ANALOG	REAL-TIME CLOCK
Count/Rate/Serial Slave	MPAXI000	MPAXI010	LPAX0600	YES	YES	YES	-
Count	MPAXC000	MPAXC010	LPAX0600	YES	-	-	-
Rate	MPAXR000	MPAXR010	LPAX0600	YES	-	-	-
Clock/Timer	MPAXCK00	MPAXCK10	LPAXCK00**	YES	YES	-	YES
Timer	MPAXTM00	MPAXTM10	LPAXCK00**	YES	YES	-	-

*For detailed module and plug-in card specifications, see corresponding PAX literature. (i.e. For MPAXI specifications, see the PAXI literature)

**The LPAXCK will only operate with the Clock/Timer MPAX input module.

OPTIONAL PLUG-IN CARDS AND ACCESSORIES



WARNING: Disconnect all power to the unit before installing Plug-in cards.

Adding Option Cards

The MPAX series meters can be fitted with up to three optional plug-in cards. However, only one card from each function type can be installed at a time. The function types include Setpoint Alarms (PAXCDS), Communications (PAXCDC), and Analog Output (PAXCDL). The cards can be installed initially or at a later date. Each optional plug-in card is shipped with installation and programming instructions.

COMMUNICATION CARDS (PAXCDC)

A variety of communication protocols are available for the PAX and MPAX series. Only one of these cards can be installed at a time. When programming the unit via Crimson (for MPAXI) or SFPAX (for MPAXCK or MPAXTM), the RS232 or RS485 Cards must be used.

- PAXCDC10 - RS485 Serial (Terminal) PAXCDC30 - DeviceNet
- PAXCDC1C - RS485 Serial (Connector) PAXCDC40 - Modbus (Terminal)
- PAXCDC20 - RS232 Serial (Terminal) PAXCDC4C - Modbus (Connector)
- PAXCDC2C - RS232 Serial (Connector) PAXCDC50 - Profibus-DP

SETPOINT CARDS (PAXCDS)

The MPAX series has four setpoint alarm output plug-in cards. Only one of these cards can be installed at a time. (Logic state of the outputs can be reversed in the programming.) These plug-in cards include:

- Dual relay, FORM-C, Normally open & closed
- Quad relay, FORM-A, Normally open only
- Isolated quad sinking NPN open collector
- Isolated quad sourcing PNP open collector

LINEAR DC OUTPUT (PAXCDL)

Either a 0(4)-20 mA or 0-10 V retransmitted linear DC output is available from the analog output plug-in card. The programmable output low and high scaling can be based on the input, max, min, or total display value. Reverse slope output is possible by reversing the scaling point positions.

PAXCDL10 - Retransmitted Analog Output Card

PROGRAMMING SOFTWARE

CRIMSON - MPAXI Only

Crimson is a Windows® based program that allows configuration of the LPAX meter from a PC. Crimson offers standard drop-down menu commands, that make it easy to program the LPAX meter. The LPAX program can then be saved in a PC file for future use. A PAX serial plug-in card is required to program the meter using the software.

SFPAX - MPAXCK and MPAXTM Only

The SFPAX is a Windows® based program that allows configuration of the LPAX meter from a PC. Using the SFPAX makes it easier to program the LPAX meter and allows saving the PAX program in a PC file for future use. On-line help is available within the software. A PAX serial plug-in card is required to program the meter using the software.

1.0 ASSEMBLING THE DISPLAY



CAUTION: The MPAX main circuit board and the option cards contain static sensitive components. Before handling the module or the cards, discharge static charges from your body by touching a grounded bare metal object. Handle the module by the rear plastic cover only, and the option cards by the board edges. Dirt, oil or other contaminants that contact the circuit boards or components can adversely affect circuit operation.



WARNING: Exposed line voltage exists on the MPAX main circuit board and the option cards. **DO NOT** apply power to the module OR load circuits until the module is properly installed in the LPAX case.



NOTE: All module and option card labels must be installed as shown for safety purposes.

Prior to installing the LPAX Display, it is recommended that the MPAX and any option cards be assembled first. This will allow you the opportunity to insure all the boards are fitted properly into their connectors.

Installing the Option Cards

If your application requires option cards, they should be installed into the MPAX before it is installed into the LPAX Display. Refer to the literature enclosed with the option cards for installation instruction.

Installing the MPAX

To install the MPAX Module, align the module with the opening in the LPAX case, as illustrated. The module must be oriented as shown, with terminal #1 toward the top of the LPAX case. Carefully slide the module into the LPAX case.

The LPAX and MPAX connectors will begin to engage about 1/4" from the bottom. At this point, apply a small amount of pressure to the rear of the MPAX module to fully engage the connection. Be sure the module fully snaps into the slots at the rear of the LPAX case. The display is ready for installation.

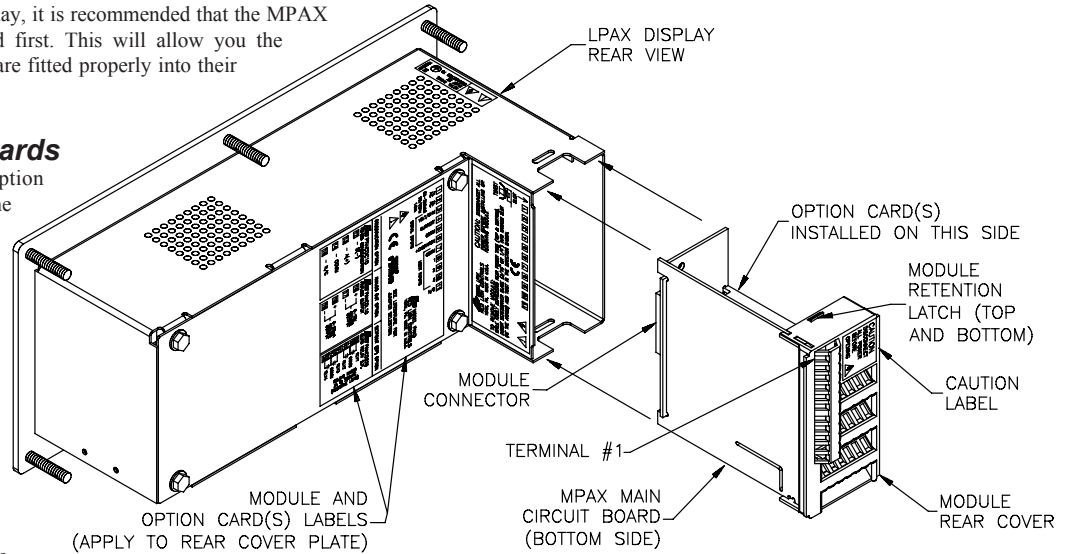

Figure 1, Installing an MPAX Module and Option Cards

Installing the Labels

Each option card and the MPAX are shipped with a connection label. These labels must be applied to the rear of the LPAX in the positions shown in the drawing.

Removing The MPAX Module

To remove the MPAX Module from the LPAX Display, first remove all power and load circuits. Then insert a flat screwdriver blade (3/16" or 1/4") into the narrow slot between the LPAX rear cover plate and the module's plastic cover as illustrated in Figure 2. Twist the screwdriver in the direction shown to disengage the internal connectors while firmly squeezing and pulling back on the rear finger tabs (top and bottom). Carefully slide the module out of the LPAX case, keeping it properly aligned with the case opening.

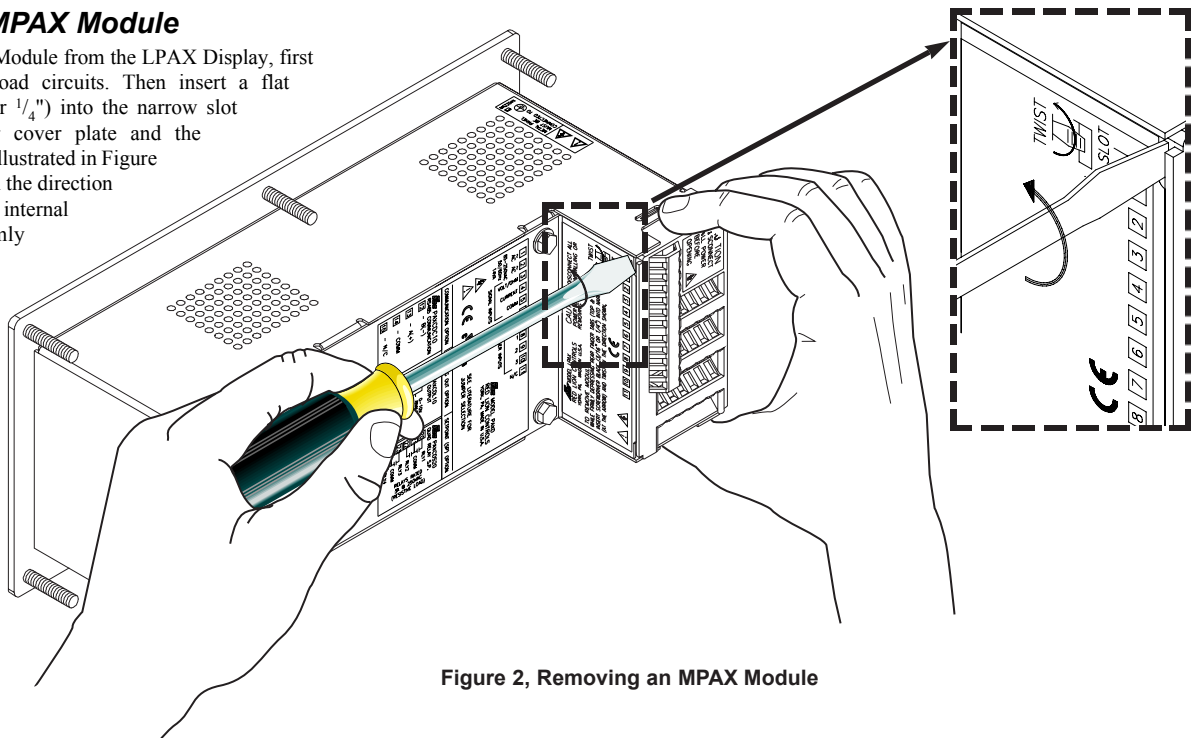

Figure 2, Removing an MPAX Module

2.0 INSTALLING THE DISPLAY

LPAX DISPLAY INSTALLATION

The LPAX display is intended to be mounted into a panel or enclosure. The display is provided with a gasket to provide a water-tight seal. The recommended minimum panel thickness for NEMA 4/IP65 sealing is 0.060" (1.57 mm).

For panel mounting, prepare the panel cut-out to the dimensions shown. The supplied template may be used to mark the cut-out and hole locations on the panel. After the panel cut-out has been deburred, slide the panel gasket over the rear of the display and onto the mounting studs. Insert the display into the panel cut-out as illustrated in Figure 3. Install six # 10-32 keps nuts (supplied) and tighten evenly for uniform gasket compression. Do not over-tighten the nuts.

By using additional mounting accessories, the LPAX can be surface-wall mounted, suspended, or bottom mounted. Separate installation instructions are provided with the mounting accessories.

Environment And Cleaning

The display should be installed in a location that does not exceed the maximum operating temperature and provides good air circulation. Placing the system near devices that generate excessive heat should be avoided.

The bezel should be cleaned only with a soft cloth and neutral soap product. Do NOT use solvents. Continuous exposure to direct sunlight may accelerate the aging process of the bezel.

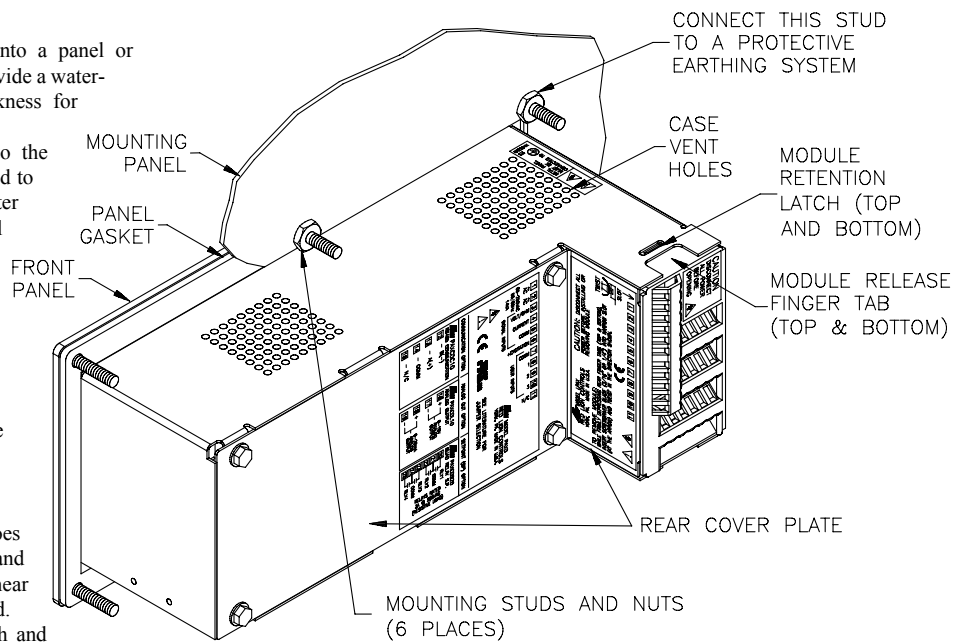

Figure 3, Installing The LPAX Into A Panel

3.0 WIRING AND PROGRAMMING THE DISPLAY

Once assembled, the LPAX and MPAX have all the same functions and capabilities of our PAX Series Intelligent Panel Meters. Therefore, you will find the appropriate PAX information packed with the MPAX Module. Simply follow the instructions to wire and program the display for your application.

TROUBLESHOOTING

For technical assistance, contact technical support.

ORDERING INFORMATION

TYPE	MODEL NO.	DESCRIPTION	PART NUMBERS		
Display	LPAX	6-Digit Display for Digital MPAX Modules	LPAX0600		
		6-Digit Display for MPAXCK (Clock/Timer) and MPAXTM Only	LPAXCK00		
Digital Input Module	MPAX	Count/Rate Indicator Module, AC Powered	MPAXI000		
		Count/Rate Indicator Module, DC/24 VAC Powered	MPAXI010		
		Count Indicator Module, AC Powered	MPAXC000		
		Count Indicator Module, DC/24 VAC Powered	MPAXC010		
		Rate Indicator Module, AC Powered	MPAXR000		
		Rate Indicator Module, DC/24 VAC Powered	MPAXR010		
		Clock/Timer Module, AC Powered	MPAXCK00		
		Clock/Timer Module, DC/24 VAC Powered	MPAXCK10		
		Timer Module, AC Powered	MPAXTM00		
		Timer Module, DC/24 VAC Powered	MPAXTM10		
		Optional Plug-In Cards	PAXCDS	Dual Setpoint Relay Output Card	PAXCDS10
				Quad Setpoint Relay Output Card	PAXCDS20
Quad Setpoint Sinking Open Collector Output Card	PAXCDS30				
Quad Setpoint Sourcing Open Collector Output Card	PAXCDS40				
PAXCDC*	RS485 Serial Communications Output Card with Terminal Block		PAXCDC10		
	Extended RS485 Serial Communications Output Card with Dual RJ11 Connector		PAXCDC1C		
	RS232 Serial Communications Output Card with Terminal Block		PAXCDC20		
	Extended RS232 Serial Communications Output Card with 9 Pin D Connector		PAXCDC2C		
	DeviceNet Communications Card		PAXCDC30		
	Modbus Communications Card		PAXCDC40		
	Extended Modbus Communications Card with Dual RJ11 Connector		PAXCDC4C		
	Profibus-DP Communications Card		PAXCDC50		
PAXCDL*	Analog Output Card		PAXCDL10		
PAXRTC*	Real Time Clock Card for MPAXCK (Clock/Timer) Only		PAXRTC00		
Accessories	SFCRD**		Crimson 2 PC Configuration Software for Windows 98, ME, 2000 and XP (for MPAXI)	SFCRD200	
	SFPAX**	PC Configuration Software for Windows 95/98 on 3.5" disk (for MPAXCK and MPAXTM)	SFPAX		
	ENC9	NEMA 4 Enclosure for LPAX	ENC90000		
	SHR	Shroud for LPAX	SHRPLAX0		
	MB	Mounting Bracket for LPAX	MBLPAX00		

*Refer to "Selecting Your Display Components and Option Cards."

**Available as a FREE download from the Red Lion website. www.redlion.net