

# Command and signalling devices

Product information



# Introduction



Dipl.-Ing. Heinz Schmersal and Dipl. Wirt.-Ing. Philip Schmersal  
Managing Associates of the K.A. Schmersal GmbH & Co. KG

## **Safety in system – Protection for man and machine**

Often, it is unavoidable that people have to intervene with the workings of a machine. When this is done the safety of the operator is imperative. This demands the responsibility of the machine operator, which is also required by the world's standards and guidelines for machine safety.

The Schmersal Group has concentrated for many years on safety at work with our products and solutions; today we can offer the industry the world's largest range of safety switchgear and systems for the protection of man and machine.

Under the guiding principle "Safety with system – protection for man and machine" we develop and produce products that carry the system concept and can be optimally integrated into the work processes. Because we are convinced that safety does not contradict higher productivity.

In our fields of activity we have a leading position due to our expertise, our innovative power and our comprehensive range of products. With this we follow a central theme: Together with you, we want to make the world a little safer. Talk to us – we look forward to working with you.

# Content

■ Schmersal	Page 4
■ Command and signalling devices	Page 8
E Program	Page 10
N Program	Page 26
R Program	Page 42
Contact and lighting elements	Page 58
Accessories	Page 66
Enclosures for surface mounting	Page 70
■ Control panels	Page 74
■ Two-hand control panels	Page 82
■ Spring-return joystick switch	Page 90
■ Enabling switches	Page 98

# History

## Milestones 1945 – 2013



Schmersal Brazil 1974



Schmersal China 2013



Startup of the new central warehouse in 2013

1945

The brothers Kurt Andreas Schmersal and Ernst Schmersal **form** the company in Wuppertal.

1950s

The **product portfolio** is continuously expanded. Many switchgears are used in safety related applications such as in explosive areas.

1970s

Schmersal is one of the first companies to begin development and production of **electronic proximity switches**.

1974

**ACE Schmersal** is formed in Boituva, Brazil.

1982

**Generational change:** Heinz and Stefan Schmersal take over the company from their fathers.

1994

Schmersal takes over **steute Schaltgeräte GmbH** based in Löhne.

1997

**ELAN Schaltelemente GmbH & Co. KG** based in Wettenberg is acquired.

1999

The production facility **Schmersal Industrial Switchgear Co. Ltd (SISS)** is formed in Shanghai, China.

2004

**Heinz Schmersal** takes over 100% of the Group.

2007

Philip Schmersal joins the **third generation of the** Schmersal Group.  
The training centre **tec.nicum** is formed.

2008

The **company kindergarten** starts with 18 children.  
In October 2008 the Schmersal Group takes over **Safety Control GmbH** and its affiliate Protec GmbH in Mühldorf/Inn.

2013

ELAN Schaltelemente merges with the Schmersal Group and the resulting entity is renamed **K.A. Schmersal GmbH & Co. KG**.  
**Böhnke + Partner Steuerungssysteme GmbH** is acquired.  
**Schmersal India** becomes a production facility.  
Startup of the new **European central warehouse** in Wuppertal.

## Schmersal worldwide

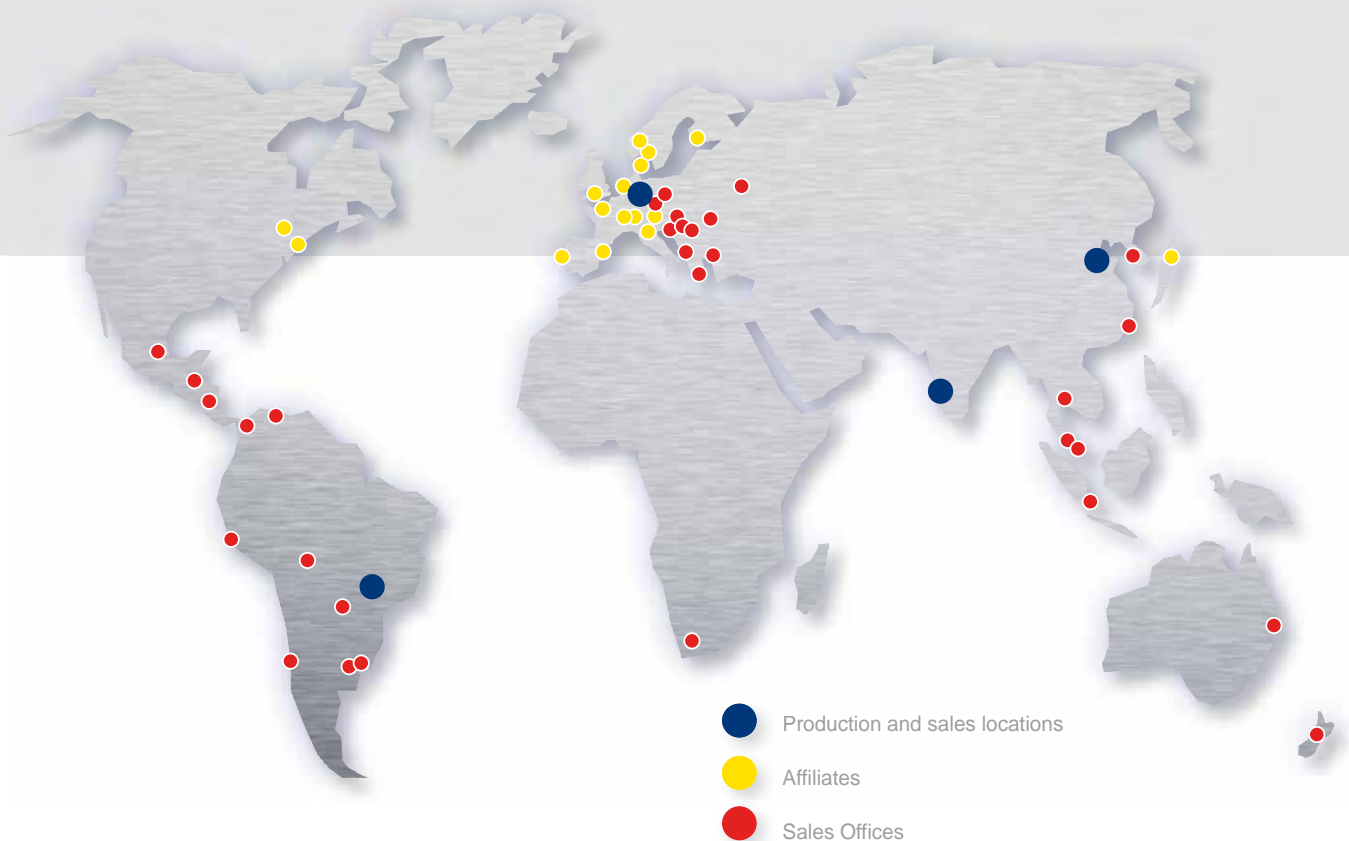

With its own affiliates in around 20 countries and capable sales and service partners in 30 more countries, the Schmersal Group has operations worldwide.

We started quite early with the internationalisation of sales, consultancy and production. This is also one of the reasons that we are a favoured global partner for machinery and plant construction and also an approved partner for many medium sized engineering companies with local presence. Wherever there are machines that work with Schmersal safety switches, the nearest branch or representative is not far away.

Germany, Wuppertal  
 Germany, Wettenberg  
 Germany, Mühldorf  
 Germany, Bergisch Gladbach  
 Brazil, Boituva  
 China, Shanghai  
 India, Ranjangaon

Belgium, Aarschot  
 Denmark, Ballerup  
 Finland, Helsinki  
 France, Seyssins  
 United Kingdom, Worcestershire  
 Italy, Borgosatollo  
 Japan, Tokyo  
 Canada, Brampton  
 Netherlands, Harderwijk  
 Norway, Oslo  
 Austria, Vienna  
 Portugal, Póvoa de Sta. Iria  
 Sweden, Mönlycke  
 Switzerland, Arni  
 Spain, Sant Cugat Sesgarrigues  
 USA, Tarrytown NY

Argentina, Buenos Aires  
 Australia, Brisbane  
 Baltic States, Kaunas  
 Bolivia, Santa Cruz de la Sierra  
 Bulgaria, Ruse City  
 Chile, Santiago  
 Ecuador, Quito  
 Greece, Athens  
 Guatemala, Guatemala-City  
 Indonesia, Jakarta  
 Iceland, Reykjavik  
 Israel, Petach Tikwa  
 Kazakhstan, Ayrn  
 Colombia, Medellín  
 South Korea, Seoul  
 Croatia, Zagreb  
 Malaysia, Rawang  
 Macedonia, Skopje  
 Mexico, Mexico City  
 New Zealand, Christchurch  
 Pakistan, Islamabad  
 Paraguay, Minga Guazú

Peru, Lima  
 Poland, Warsaw  
 Romania, Sibiu  
 Russia, Moscow  
 Serbia, Belgrade  
 Singapore, Singapore  
 Slovenia, Ljubljana  
 South Africa, Johannesburg  
 Taiwan, Taichung  
 Thailand, Bangkok  
 Czech Republic, Prague  
 Turkey, Istanbul  
 Ukraine, Kiev  
 Hungary, Győr  
 Uruguay, Montevideo  
 United Arab Emirates, Sharjah  
 Venezuela, Caracas  
 Vietnam, Hanoi  
 Belarus, Minsk

# Schmersal Worldwide

## Offices in Germany

### Wuppertal



#### **K.A. Schmersal GmbH & Co. KG**

Founded in 1945  
Around 600 employees

#### **Focal points**

Headquarters of the Schmersal Group  
Development and manufacture of switchgears and switching systems for safety, automation and lift engineering  
Accredited test laboratory  
Central research and development  
Logistics centre for European markets

### Wettenberg



#### **K.A. Schmersal GmbH & Co. KG**

Founded in 1952 (1997)  
Around 150 employees

#### **Focal points**

Development and manufacture of switchgears for operation and monitoring, safety-related relay modules and controls as well as switchgears for explosion protection

### Mühdorf / Inn



#### **Safety Control GmbH**

Founded in 1994 (2008)  
Around 30 employees

#### **Focal points**

Development and manufacture of optical electronic components for safety and automation engineering

### Bergisch Gladbach



#### **Böhnke + Partner Steuerungssysteme GmbH**

Founded in 1991 (2012)  
Around 70 employees

#### **Focal points**

Development and manufacture of components, controls and remote diagnostic systems for the lift industry

( ) = inclusion in the Schmersal Group

# Schmersal Worldwide

## International Offices

### Boituva / Brazil



#### ACE Schmersal

Founded in 1974  
Around 350 employees

#### Focal points

Manufacture of electromechanical and electronic switchgears  
Customer-specific control systems for the North and South American market

---

### Shanghai / China



#### Schmersal Industrial Switchgear Co. Ltd

Founded in 1999  
Around 150 employees

#### Focal points

Development and manufacture of switchgears for safety, automation and lift engineering for the Asian market

---

### Ranjangaon / India



#### Schmersal India Private Limited

Founded in 2013  
Around 30 employees

#### Focal points

Development and manufacture of switchgears for safety, automation and lift engineering for the Indian market

# Command and signalling devices

## Description

### Command and signalling devices

Command and signalling devices make possible communication between human beings and machines. People expect high levels of reliability from them. Intuitive operation is desirable not just from an ergonomic point of view, but also with regards to safety at work.

The type of machine and the environmental conditions mean that the demands made of command and signalling devices are very different. Consequently, there are a wide range of different construction forms. In addition to classic command devices and indicator lights for installation on operator panels, pull-wire switches, foot switches, cross-switches and buttons as well as two-hand controls and enabling devices, for example are in common use.

As an all-rounder in the field of HMI components and systems, the Schmersal Group offers a range of products for (virtually) all areas of application. These include command and signalling device series that have been developed for dedicated use in hygiene-sensitive areas (Series N) as well as for extremely harsh ambient conditions (Series R).

All our ranges are distinguished by their very high levels of quality and their long service lives. They are of modular structure, which means you can adapt them in an optimum way to meet the exact requirements of your own individual application.

With contact systems too, users have different choices (see Page 58: Contact Systems). Apart from this, assembly housings are available for all three series. If desired, command and signalling devices are supplied pre-assembled or ready-to-connect to operating systems with housings (see Page 70: Enclosures).





	"E" program	"N" program	"R" program
<b>Area of application</b>	Applications under difficult operating conditions	Food, hygiene and external applications	Heavy-duty applications
<b>EMERGENCY STOP command device</b>	 see page 12	 see page 28	 see page 44
<b>Illuminated signal</b>	 see page 14	 see page 30	 see page 46
<b>Pushbutton</b>	 see page 16	 see page 32	 see page 48
<b>Illuminated pushbutton</b>	 see page 16	 see page 32	 see page 48
<b>Mushroom head impact button/ EMERGENCY STOP pushbutton</b>	 see page 18	 see page 34	 see page 50
<b>Selector switch/ key button</b>	 see page 20	 see page 36	 see page 52
<b>Key-operated selector switch</b>	 see page 22	—	 see page 54
<b>Step switch</b>	 see page 24	 see page 40	 see page 56
<b>Potentiometer drive</b>	 see page 24	 see page 40	 see page 56
<b>Main switches</b>	—	 see page 38	—

# Command and signalling devices

## "E" program

### Area of application

The Series E command and signalling devices for 22.3 mm and 30 mm installation boreholes have been developed as universal operator input and display elements for all mechanical engineering, plant construction and automotive applications. They are generally integrated in the control panels or enclosures of machines and are in use all over the world.

The separate N and R product portfolios are available for applications that make particular demands of either hygiene or the toughness of the command and signalling devices.

### Design and way of functioning

The command and signalling devices of Series E are each designed with an operating button and an EF contact system. Both parts are simply joined by catch springs. This principle ensures fast assembly on the front panel of the control panel and a permanent connection between the head and the contact system. When doing this, the modular principle of this range makes it possible to increase flexibility and to adapt the Human Machine Interface to individual requirements in an optimum way.

The control heads of Series E are made from anodized aluminium, with the collars being glass. The seals on the front of the devices complies with protection class IP 67/65.

Users can choose between a vast range of different variants. The product portfolio includes amongst other things push buttons, mushroom head impact buttons, illuminated control push buttons and indicator lights, selector switches and selection buttons as well as key selector switches and key selection buttons.

In the E range, the mushroom head impact buttons are particularly important. They are used all over the world in mechanical engineering and plant construction and stand out due to their extremely robust design. On vibrating machines or with frequent shock loading, these EMERGENCY STOP buttons function reliably and thus increases the machines' productivity and extend their service lives. If the EMERGENCY STOP button fails, the safety system shuts down the machine, this happens extremely rarely with E and N range switchgears with an external snap-action mechanism.

Program-Overview		Page
1	EMERGENCY STOP	12
2	EMERGENCY STOP with release by key	12
3	Pushbutton	16
4	Mushroom head impact button/ EMERGENCY STOP pushbutton	18
5	Key-operated selector switch/ button	22
6	Selector switch/key button	20
7	Illuminated pushbutton	16
8	Illuminated signal	14
9	Step selector switch	24
10	Potentiometer drive	24
11	Mounting flange EFM	63
12	Mounting flange EFMH	-
13	Short-stroke key element	-
14	Mounting flange ELM	63
15	Contact element EF	63
16	Spring element EFR	63
17	Securing plate	-
18	Position switches	-
19	Contact element EFK...	-
20	Light terminal block ELDE...	63
21	Light terminal block EL...	63
22	EMERGENCY STOP label	66
23	EMERGENCY STOP protective collar	66
24	EMERGENCY STOP enclosure for surface mounting	70
25	Identification label	66
26	Plastic enclosure for surface mounting	70
27	Adapter ring	68
28	Blanking plug	68



# Command and signalling devices – E programme

## EMERGENCY STOP control devices



■ EDRR40RT



■ EDRZ40RT



■ EDRRS40RT

### Key Features

<b>General description</b>	EMERGENCY STOP - with twist and pull-to-unlatch mechanism	EMERGENCY STOP - with pull-to-unlatch mechanism	EMERGENCY STOP - with key unlatching mechanism
<b>Area of application</b>	Applications under difficult operating conditions	Applications under difficult operating conditions	Applications under difficult operating conditions
<b>Mounting-Ø</b>	22.3 mm	22.3 mm	22.3 mm
<b>Housing material</b>			
<b>Material of operating element</b>	Aluminium	Aluminium	Chrome-plated brass
<b>Material front ring</b>	Aluminium	Aluminium	Aluminium

### Other designs are available

<b>Mounting-Ø 30.5 mm</b>	■	■	■
---------------------------	---	---	---

### Technical features

<b>Mechanical data</b>			
<b>Colour</b>	■	■	■
<b>Design</b>	round	round	round
<b>Front panel thickness</b>	1...6 mm	1...6 mm	1...6 mm
<b>Unlocking type</b>	Twist and pull-to-unlatch mechanism	Pull-to-unlatch mechanism	Release by key
<b>Snap-action mechanism</b>			
<b>Integrated</b>	-	■	-
<b>Externally via additional module</b>	■	-	■
<b>Mounting</b>			
<b>Mounting flange included in delivery</b>	■	■	■
<b>Mounting position</b>	any	any	any
<b>Ambient conditions</b>			
<b>Ambient temperatures</b>	-25 °C ... +75 °C	-25 °C ... +75 °C	-25 °C ... +75 °C
<b>IP Protection class</b>	IP65	IP65	IP65

### Safety classification

<b>Standards</b>	EN ISO 13850; IEC 60947-5-1; IEC 60947-5-5; IEC 60947-1	EN ISO 13850; IEC 60947-5-1; IEC 60947-5-5; IEC 60947-1	EN ISO 13850; IEC 60947-5-1; IEC 60947-5-5; IEC 60947-1
<b>Mechanical life</b>	100,000 operations	100,000 operations	100,000 operations
<b>Certificates</b>			
<b>Note</b>	cULus in conjunction with the corresponding contact elements only		

## Command and signalling devices – E programme

### EMERGENCY STOP control devices

Type	Unlocking	Snap-action mechanism	A	B	C	Type designation	Material number
<b>EMERGENCY STOP push buttons</b>	Pull-to-unlatch mechanism	Integrated	29	22.3	38.5	<b>EDRZ40 RT</b>	<b>101177107</b>
				30.5		<b>EDRZ40VH RT</b>	<b>101182360</b>
	Twist and pull-to-unlatch mechanism	External with spring element EFR *	29	22.3	38.5	<b>EDRR40 RT</b>	<b>101021009</b>
					49	<b>EDRR50 RT</b>	<b>101021015</b>
				30.5	38.5	<b>EDRR40VH RT</b>	<b>101024290</b>
					49	<b>EDRR50VH RT</b>	<b>101024299</b>
	Release by key (cover red)	External with spring element EFR.EDRRS *	29	22.3	37.5	<b>EDRRS40 RT</b>	<b>101025432</b>
				30.5		<b>EDRRS40VH RT</b>	<b>101025435</b>

\* Spring element EFR or EFR.EDRRS must be ordered separately!

All dimensions in mm.

#### Key

A	Height	Height of command device in front of the front panel
B	Mounting-Ø	Installation diameter for the command device head
C	Key Ø	Width of command device head

# Command and signalling devices – E programme

## Illuminated signal



■ EML / EMLH

■ EME / EMEH

### Key Features

<b>General description</b>	Illuminated signal for BA9s	Illuminated signal with integrated LED
<b>Area of application</b>	Applications under difficult operating conditions	Applications under difficult operating conditions
<b>Mounting-Ø</b>	22.3 mm	22.3 mm
<b>Housing material</b>		
<b>Material of operating element</b>	Glass	Glass
<b>Material front ring</b>	Aluminium	Aluminium

### Other designs are available

<b>Mounting-Ø 30.5 mm</b>	■	■
<b>Vandal-proof devices</b>	■	■

### Technical features

<b>Mechanical data</b>		
<b>Colour</b>		
<b>Design</b>	Round with flat or high glass	Round with flat or high glass
<b>Front panel thickness</b>	1...6 mm	1...6 mm
<b>Integrated LED 24 VAC/DC *</b>	-	■
<b>Mounting</b>		
<b>Mounting flange included in delivery</b>	■	■
<b>Mounting position</b>	any	any
<b>Ambient conditions</b>		
<b>Ambient temperatures</b>	-25 °C ... +75 °C	-25 °C ... +40 °C
<b>IP Protection class</b>	IP65	IP65

### Safety classification

<b>Standards</b>	IEC 60947-5-1; IEC 60947-1	IEC 60947-5-1; IEC 60947-1
<b>Mechanical life</b>	-	-
<b>Certificates</b>		
<b>Note</b>	cULus in conjunction with the corresponding contact elements only	

\* A voltage sensor, e.g. an ELE is also needed for driving. You can find the voltage sensors on page 58

# Command and signalling devices – E programme

## Illuminated signal

Type	Illuminant	Collar	A	B	C	Type designation
Illuminated signal	Without integrated illuminant	Flat collar	14	22.3	29.5	<b>EML</b> ①
			2.5	30.5	34.5	<b>EML.V</b> ①
		High collar	20	22.3	29.5	<b>EMLH</b> ①
			2.5	30.5	34.5	<b>EMLH.V</b> ①
LED indicator light	With integrated illuminant	High collar	20	22.3	29.5	<b>EME</b> ①

① **Abbreviations of colours:** ■ BK ■ GB ■ RD ■ GN □ WH ■ BL  
 You append the abbreviations of the colours to the type designation.  
 For details of possible colour combinations, refer to the technical data on the previous page.

All dimensions in mm.

### Key

- A Height      Height of command device in front of the front panel
- B Mounting-Ø      Installation diameter for the command device head
- C Key Ø      Width of command device head



EML GN



EMLH RT



EME GB



EME.V BL

# Command and signalling devices – E programme

## Pushbuttons and illuminated pushbuttons



■ EDT

■ EDL

### Key Features

<b>General description</b>	Pushbutton	Illuminated pushbutton
<b>Area of application</b>	Applications under difficult operating conditions	Applications under difficult operating conditions
<b>Mounting-Ø</b>	22.3 mm	22.3 mm
<b>Housing material</b>		
<b>Material of operating element</b>	Aluminium	Glass
<b>Material front ring</b>	Aluminium	Aluminium

### Other designs are available

<b>Mounting-Ø 30.5 mm</b>	■	■
<b>Vandal-proof devices</b>	■	■

### Technical features

<b>Mechanical data</b>		
<b>Colour</b>		
<b>Design</b>	round	round
<b>Front panel thickness</b>	1...6 mm	1...6 mm
<b>Mounting</b>		
<b>Mounting flange included in delivery</b>	■	■
<b>Mounting position</b>	any	any
<b>Ambient conditions</b>		
<b>Ambient temperatures</b>	-25 °C ... +75 °C	-25 °C ... +75 °C
<b>IP Protection class</b>	IP65	IP65

### Safety classification

<b>Standards</b>	IEC 60947-5-1; IEC 60947-1	IEC 60947-5-1; IEC 60947-1
<b>Mechanical life</b>	10,000,000 operations	5,000,000 operations
<b>Certificates</b>		
<b>Note</b>	cULus in conjunction with the corresponding contact elements only	



# Command and signalling devices – E programme

## Pushbuttons and illuminated pushbuttons

Type	Description	A	B	C	Type designation	
Pushbutton	Standard	Standard	14	22.3	29.5	EDT ①
		2 mm-high key	16	22.3	29.5	EDT2 ①
		6 mm-high key	20	22.3	29.5	EDT6 ①
		6 mm edge to prevent unwanted activation	20	22.3	29.5	EDTH ①
	With membrane	Standard	14	22.3	29.5	EDM ①
		6 mm edge to prevent unwanted activation	20	22.3	29.5	EDMH ①
	With latching	Standard	14	22.3	29.5	EDTR ①
Illuminated pushbutton	Standard	Standard	14	22.3	29.5	EDL ①
		6 mm edge to prevent unwanted activation	20	22.3	29.5	EDLH ①
	With membrane	Standard	14	22.3	29.5	EDLM ①
		6 mm edge to prevent unwanted activation	20	22.3	29.5	EDLMH ①
	With latching	Standard	14	22.3	29.5	EDLR ①

① **Abbreviations of colours:**  BK  GB  RD  GN  WH  BL  
 You append the abbreviations of the colours to the type designation.  
 For details of possible colour combinations, refer to the technical data on the previous page.

All dimensions in mm.

### Key

- A Height Height of command device in front of the front panel
- B Mounting-Ø Installation diameter for the command device head
- C Key Ø Width of command device head



EDM RT



EDT2 GB



EDT6.V GB



EDLMH BL



EDL GN

# Command and signalling devices – E programme

## Mushroom head impact button



### Key Features

<b>General description</b>	Mushroom button without latching function	Mushroom button with latching function	Mushroom button with latching function and release by key
<b>Area of application</b>	Applications under difficult operating conditions	Applications under difficult operating conditions	Applications under difficult operating conditions
<b>Mounting-Ø</b>	22.3 mm	22.3 mm	22.3 mm
<b>Housing material</b>			
<b>Material of operating element</b>	Aluminium	Aluminium	Chrome-plated brass
<b>Material front ring</b>	Aluminium	Aluminium	Aluminium

### Other designs are available

<b>Mounting-Ø 30.5 mm</b>	EDP40 version only	-	■
---------------------------	--------------------	---	---

### Technical features

<b>Mechanical data</b>			
<b>Colour</b>			
<b>Design</b>	round	round	round
<b>Front panel thickness</b>	1...6 mm	1...6 mm	1...6 mm
<b>With latching</b>	-	■	■
<b>Mounting</b>			
<b>Mounting flange included in delivery</b>	■	■	■
<b>Mounting position</b>	any	any	any
<b>Ambient conditions</b>			
<b>Ambient temperatures</b>	-25 °C ... +75 °C	-25 °C ... +75 °C	-25 °C ... +75 °C
<b>IP Protection class</b>	IP65	IP65	IP65

### Safety classification

<b>Standards</b>	IEC 60947-5-1; IEC 60947-1	IEC 60947-5-1; IEC 60947-1	IEC 60947-5-1; IEC 60947-1
<b>Mechanical life</b>	10,000,000 operations	10,000,000 operations	10,000,000 operations
<b>Certificates</b>			
<b>Note</b>	cULus in conjunction with the corresponding contact elements only		

# Command and signalling devices – E programme

## Mushroom head impact button

Type	Description	Key	A	B	C	Type designation	
<b>Mushroom head impact button</b>	Mushroom head impact button	Mushroom-shaped	27.5	22.3	32	<b>EDP</b> ①	
			27.5	22.3	37	<b>EDP40</b> ①	
			27.5	22.3	55	<b>EDP55</b> ①	
			27.5	22.3	70	<b>EDP70</b> ①	
		Flat key		27.5	22.3	35	<b>EDP35</b> ①
	Mushroom button with latching function	Mushroom-shaped		29	22.3	38.5	<b>EDR40</b> ①
				27.5	22.3	70	<b>EDR70</b> ①
		Flat key		27.5	22.3	35	<b>EDR35</b> ①
Release by key			29	22.3	38	<b>EDRS40</b> ①	

① **Abbreviations of colours:** ■ BK ■ GB ■ RD ■ GN □ WH ■ BL  
 You append the abbreviations of the colours to the type designation.  
 For details of possible colour combinations, refer to the technical data on the previous page.

All dimensions in mm.

### Key

- A Height Height of command device in front of the front panel
- B Mounting-Ø Installation diameter for the command device head
- C Key Ø Width of command device head



EDP SW



EDP70 GN



EDR35 GN



EDR70 GB



EDRS40 RT

# Command and signalling devices – E programme

## Maintained selector switches and spring return selector switches



■ EWS / EWT

■ EWS .1 / EWT .1

■ EWS DB / EWT DB

### Key Features

<b>General description</b>	Selector switch/button with short toggle	Selector switch/button with long toggle	Selector switch/key button with rectangular activator
<b>Area of application</b>	Applications under difficult operating conditions	Applications under difficult operating conditions	Applications under difficult operating conditions
<b>Mounting-Ø</b>	22.3 mm	22.3 mm	30.5 mm
<b>Toggle length</b>	28 mm	45 mm	-
<b>Housing material</b>			
<b>Material of operating element</b>	Thermoplastic	Thermoplastic	Metal
<b>Material front ring</b>	Aluminium	Aluminium	Aluminium

### Other designs are available

<b>Mounting-Ø 30.5 mm</b>	■	■	-
---------------------------	---	---	---

### Technical features



<b>Mechanical data</b>			
<b>Colour</b>	■	■	Metal (silver)
<b>Design</b>	round	round	round
<b>Front panel thickness</b>	1...6 mm	1...6 mm	1.5...14 mm
<b>Maintained switching positions</b>	2...3 positions	2...3 positions	2...3 positions
<b>Mounting</b>			
<b>Mounting flange included in delivery</b>	■	■	-
<b>Mounting position</b>	any	any	any
<b>Ambient conditions</b>			
<b>Ambient temperatures</b>	0 °C ... +75 °C	0 °C ... +75 °C	-40 °C ... +80 °C
<b>IP Protection class</b>	IP65	IP65	IP65

### Safety classification

<b>Standards</b>	IEC 60947-5-1; IEC 60947-1	IEC 60947-5-1; IEC 60947-1	IEC 60947-5-1; IEC 60947-1
<b>Mechanical life</b>	300,000 operations	300,000 operations	300,000 operations
<b>Certificates</b>			
<b>Note</b>	cULus in conjunction with the corresponding contact elements only		

## Command and signalling devices – E programme

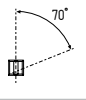
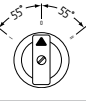
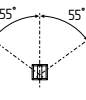
### Maintained selector switches and spring return selector switches

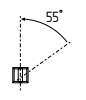
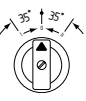
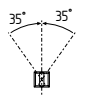
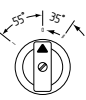
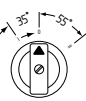
Type	Maintained and momentary positions	Positions	Actuator	A	B	C	Type designation
Selector switch	2 maintained positions		Short toggle	28	22.3	29.5	EWS21
			Long toggle				EWS21.1
			Rectangular actuator	6	30.5	36	EWS21DB
			EWS21ÖBB				
	3 maintained positions		Short toggle	28	22.3	29.5	EWS32
			Long toggle				EWS32.1
		Rectangular actuator	6	30.5	36	EWS32DB	
		EWS32ÖBB					
Spring-return selector switch	1 momentary position and automatic return to the zero position		Short toggle	28	22.3	29.5	EWT21
			Long toggle				EWT21.1
			Rectangular actuator	6	30.5	36	EWT21DB
			EWT21ÖBB				
	1 momentary position each to the right and left of the zero position		Short toggle	28	22.3	29.5	EWT32
			Long toggle				EWT32.1
			Rectangular actuator	6	30.5	36	EWT32DB
			EWT32ÖBB				
Maintained spring-return rotary selector switch	Maintained position to left and momentary position to right		Short toggle	28	22.3	29.5	EWTS32
			Long toggle				EWTS32.1
	Maintained position on right and momentary position on left		Short toggle	6	30.5	36	EWTS321
			Long toggle				EWTS321.1

#### ① Toggle length:

If you want a long toggle, append a "1" to the type designation.

All dimensions in mm.

#### Key

A	Height	Height of command device in front of the front panel
B	Mounting-Ø	Installation diameter for the command device head
C	Key Ø	Width of command device head

## Command and signalling devices – E programme

### Key selector switches, buttons and -touch contact switches



■ ESS

■ EST

#### Key Features

<b>General description</b>	Key-operated selector switch	Key-operated spring-return selector switch
<b>Area of application</b>	Applications under difficult operating conditions	Applications under difficult operating conditions
<b>Mounting-Ø</b>	22.3 mm	22.3 mm
<b>Housing material</b>		
<b>Material of operating element</b>	Aluminium	Aluminium
<b>Material front ring</b>	Aluminium	Aluminium



#### Other designs are available

<b>Mounting-Ø 30.5 mm</b>	on request	on request
---------------------------	------------	------------

#### Technical features



<b>Mechanical data</b>		
<b>Colour</b>	Metal (silver)	Metal (silver)
<b>Design</b>	round	round
<b>Front panel thickness</b>	1...6 mm	1...6 mm
<b>Maintained switching positions</b>	2 or 3 positions	2 or 3 positions
<b>Mounting</b>		
<b>Mounting flange included in delivery</b>	■	■
<b>Mounting position</b>	any	any
<b>Ambient conditions</b>		
<b>Ambient temperatures</b>	0 °C ... +75 °C	0 °C ... +75 °C
<b>IP Protection class</b>	IP65	IP65

#### Safety classification

<b>Standards</b>	IEC 60947-5-1; IEC 60947-1	IEC 60947-5-1; IEC 60947-1
<b>Mechanical life</b>	300,000 operations	300,000 operations
<b>Certificates</b>		
<b>Note</b>	cULus in conjunction with the corresponding contact elements only	

## Command and signalling devices – E programme

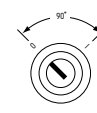
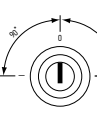
### Key selector switches, buttons and -touch contact switches

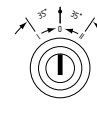
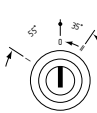
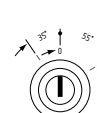
Type	Maintained and momentary positions	Key positions	Key-withdrawal position	A	B	C	Type designation
Key-operated selector switch	2 maintained positions		O	33	22.3	29.5	ESS21S1
			I				ESS21S2
			O + I				ESS21S12
	3 maintained positions		I	33	22.3	29.5	ESS32S1
			O				ESS32S2
			II				ESS32S3
			I + O + II				ESS32S123
	Key-operated spring-return selector switch	1 momentary position and automatic return to the zero position		O	33	22.3	29.5
2 momentary positions on the right and left with automatic return to the zero position			O	33	22.3	29.5	EST32S2
Key-operated selector switch pushbutton	3 positions: momentary position 35° actuating angle and maintained position 55° actuating angle (zero position in middle, key position at top)		I	33	30.5	34.5	ESTS32S1
			O				ESTS32S2
			O				ESTS321S2
			II				ESTS321S3

All dimensions in mm.

#### Key

- A Height Height of command device in front of the front panel without key
- B Mounting-Ø Installation diameter for the command device head
- C Key Ø Width of command device head

# Command and signalling devices – E programme

## Special devices



■ EWSE..K



■ EDAN6

### Key Features

<b>General description</b>	Step selector switch	Potentiometer drive
<b>Area of application</b>	Applications under difficult operating conditions	Applications under difficult operating conditions
<b>Mounting-Ø</b>	22.3 mm	22.3 mm
<b>Housing material</b>		
<b>Material of operating element</b>	Thermoplastic	Thermoplastic
<b>Material front ring</b>	Aluminium	Aluminium

### Other designs are available

<b>Mounting-Ø 30.5 mm</b>	on request	■
---------------------------	------------	---

### Technical features

<b>Electrical data</b>		
<b>Cam-operated switch</b>	Kraus & Naimer Series CA10	-
<b>Contacts</b>	One NO contact per stage	-
<b>Insulation voltage <math>U_i</math></b>	690V	-
<b>Utilisation category AC-15</b>	220 V...240 V / 5 A, 380 V...440 V / 4 A	-
<b>Rated impulse withstand voltage. <math>U_{imp}</math></b>	6 kV	-
<b>Rated continuous current <math>I_{the}</math></b>	20 A	-
<b>Fuse rating</b>	gG 25 A	-
<b>Cable section</b>	max. 2 x 2.5 mm <sup>2</sup> *	-
<b>Mechanical data</b>		
<b>Colour</b>		
<b>Operating element</b>	■	■
<b>Front ring</b>	Silver	Silver
<b>Front panel thickness</b>	1 ... 6 mm	1 ... 6 mm
<b>Maintained switching positions</b>	3 ... 12 positions	Infinite
<b>Mounting</b>		
<b>Integrated mounting plate</b>	■	■
<b>Mounting position</b>	any	any
<b>Ambient conditions</b>		
<b>Ambient temperatures</b>	0 °C ... +60 °C	0 °C ... +75 °C
<b>IP protection class (device head)</b>	IP65	IP65

### Safety classification

<b>Standards</b>	IEC 60947-3 (VDE 0660 Part 107)	-
<b>Mechanical life</b>	Load-dependent	-
<b>Certificates</b>		-

\* Use copper conductors only



# Command and signalling devices – E programme

## Special devices

Type	Circuit diagram and connecting terminals	Switching angle	L	LE	A	B	C	Type designation
Cam switching design step switches with latching mechanism, 1-pole no zero position		60°	40.7	60	28	22.3	29.5	EWSE3K
		60°	40.7	60	28	22.3	29.5	EWSE4K
		60°	50.2	69.5	28	22.3	29.5	EWSE5K
		60°	50.2	69.5	28	22.3	29.5	EWSE6K
		45°	59.7	78	28	22.3	29.5	EWSE7K
		45°	59.7	78	28	22.3	29.5	EWSE8K
		30°	69.2	87.5	28	22.3	29.5	EWSE9K
		30°	69.2	87.5	28	22.3	29.5	EWSE10K
		30°	78.7	97	28	22.3	29.5	EWSE11K
		30°	78.7	97	28	22.3	29.5	EWSE12K

Type	Description	LE	A	B	C	Type designation
Potentiometer drive	for 6 mm shaft Ø, shaft length 30 ... 40 mm	63	28	22.3	29.5	EDAN 6

All dimensions in mm.

### Key

A	Height	Height of command device in front of the front panel
B	Mounting-Ø	Installation diameter for the command device head
C	Key Ø	Width of command device head
L	Length	Length of step switch block
LE	Installation depth	Length between command device head and bottom edge of switch when mounted

# Command and signalling devices

## "N" program

### Area of application

Series N was originally developed for the specific requirements of food industry mechanical engineering. The command and signalling devices of the machines for this branch of industry must comply with strict hygiene requirements and be easy to clean.

Series N command and signalling devices meet the requirements of Protection class IP69K. This means that even when cleaned on a regular basis using high-pressure cleaners they have an outstanding long service life. They were designed on the basis of the general design concepts for hygienic construction of food processing machinery (EN 1762-2). This means, for example, that the geometry of the devices has no sharp edges. Type examination carried out by the Meat Trade Association confirmed that the design of the N programme was hygiene-appropriate.

In addition, the devices are clean room-approved and also due to their resistance to spray water, they are deployed in outdoor-applications, e.g. on municipal vehicles and in car washes. Apart from this, they are tried and tested in extreme applications in food processing, e.g. fish filleting and packaging lines that are installed directly on trawlers.

### Design and way of functioning

The N series is of modular structure too which means that machine tool builders always have available a wide selection of different command and signalling devices. The device heads each have one mounting flange that provides effective sealing in conjunction with a labyrinth seal. The EF contact system (see page 62) is used in exactly the same way as with the series.

The N range is characterised by the short actuating stroke of the command devices and the high protection class even behind the front plate. This is a significant benefit in butchers' machines, for example, since condensation can form inside the machines.

The special features of the N range include main switches for up to 63 A. They allow design engineers to design the entire control unit of a (food) machine using just one range of products.

Program-Overview		Page
1	EMERGENCY STOP	28
2	Pushbutton	32
3	Mushroom head impact button/ EMERGENCY STOP pushbutton	34
4	Selector switch/key button	36
5	Illuminated pushbutton	32
6	Illuminated signal	30
7	Step selector switch	40
8	Potentiometer drive	40
9	Mounting flange EFM	63
10	Mounting flange EFMH	-
11	Short-stroke key element	-
12	Mounting flange ELM	63
13	Contact element EF	63
14	Spring element EFR	63
15	Securing plate	-
16	Position switches	-
17	Contact element EFK...	-
18	Light terminal block ELDE...	63
19	Light terminal block EL...	63
20	EMERGENCY STOP label	66
21	EMERGENCY STOP protective collar	66
22	Identification label	66
23	Stainless steel enclosure for surface mounting	70
24	Adapter ring	68
25	Blanking plug	66



# Command and signalling devices – N programme

## EMERGENCY STOP control devices



■ NDRR50RT







■ NDRZ50RT



### Key Features

<b>General description</b>	EMERGENCY STOP - with pull-to-unlatch mechanism by integrated snap-action mechanism	EMERGENCY STOP - with pull-to-unlatch mechanism by separate spring element
<b>Area of application</b>	Food, hygiene and outdoor applications	Food, hygiene and outdoor applications
<b>Mounting-Ø</b>	22.3 mm	22.3 mm
<b>Housing material</b>		
<b>Material of operating element</b>	ABS	ABS
<b>Material front ring</b>	ABS, chrome-plated	ABS, chrome-plated

### Technical features

<b>Mechanical data</b>		
<b>Colour of the operating element</b>		
<b>Colour of sealing membranes</b>		
<b>Design</b>	round	round
<b>Front panel thickness</b>	1...6 mm	1...6 mm
<b>Unlocking type</b>	Pull-to-unlatch mechanism	Pull-to-unlatch mechanism
<b>Snap-action mechanism</b>		
<b>Integrated</b>	-	■
<b>Externally via additional module</b>	■	-
<b>Mounting</b>		
<b>Mounting flange included in delivery</b>	■	■
<b>Mounting position</b>	any	any
<b>Ambient conditions</b>		
<b>Ambient temperatures</b>	-25 °C ... +80 °C	-25 °C ... +80 °C
<b>IP Protection class</b>	IP69K	IP69K

### Safety classification

<b>Standards</b>	IEC 60947-5-1; IEC 60947-5-5; IEC 60947-1; EN ISO 13850	IEC 60947-5-1; IEC 60947-5-5; IEC 60947-1; EN ISO 13850
<b>Mechanical life</b>	100,000 operations	100,000 operations
<b>Certificates</b>		
<b>Note</b>	cULus in conjunction with the corresponding contact elements only	

## Command and signalling devices – N programme

### EMERGENCY STOP control devices

Type	Unlocking	Snap-action mechanism	Bellows	A	B	C	Type designation	Material number
<b>EMERGENCY STOP command device</b>	Pull-to-unlatch mechanism	Integrated	White	45	22.3	50	<b>NDRZ50RT</b>	<b>101177168</b>
			Black				<b>NDRZ50GR/RT</b>	<b>101177170</b>
		External with spring element EFR *	White				<b>NDRR50RT</b>	<b>101163587</b>
			Black				<b>NDRR50GR/RT</b>	<b>101163594</b>

\* Spring element EFR must be ordered separately.

All dimensions in mm.

#### Key

A	Height	Height of command device in front of the front panel
B	Mounting-Ø	Installation diameter for the command device head
C	Key Ø	Width of command device head

# Command and signalling devices – N programme

## Illuminated signal



■ NML / NMLH



■ NME / NMEH

### Key Features

<b>General description</b>	LED indicator light for LED illuminants	Illuminated signal with integrated LED
<b>Area of application</b>	Food, hygiene and outdoor applications	Food, hygiene and outdoor applications
<b>Mounting-Ø</b>	22.3 mm	22.3 mm
<b>Housing material</b>		
<b>Material of operating element</b>	PA (12)	PA (12)
<b>Material front ring</b>	ABS, chrome-plated	ABS, chrome-plated

### Technical features

<b>Mechanical data</b>		
<b>Colour of the operating element</b>		
<b>Colour of seal</b>	–	–
<b>Design</b>	Round, flat or high collar	Round, flat or high collar
<b>Front panel thickness</b>	1...6 mm	1...6 mm
<b>Integrated LED 24 VAC/DC *</b>	–	■
<b>Mounting</b>		
<b>Mounting flange included in delivery</b>	■	■
<b>Mounting position</b>	any	any
<b>Ambient conditions</b>		
<b>Ambient temperatures</b>	–25 °C ... +80 °C	–25 °C ... +80 °C
<b>IP Protection class</b>	IP69K	IP69K

### Safety classification

<b>Standards</b>	IEC 60947-5-1; IEC 60947-1	IEC 60947-5-1; IEC 60947-1
<b>Mechanical life</b>	–	–
<b>Certificates</b>		
<b>Note</b>	cULus in conjunction with the corresponding contact elements only	

\* A voltage sensor, e.g. an ELE is also needed for driving. You can find the voltage sensors on page 58

## Command and signalling devices – N programme

### Illuminated signal

Type	Description		A	B	C	Type designation
Illuminated signal	Without integrated illuminant	Flat collar	9	22.3	44.5	<b>NML</b> ①
		High collar	17.4	22.3	44.5	<b>NMLH</b> ①
LED indicator light	With integrated illuminant	Flat collar	9	22.3	44.5	<b>NMEF</b> ①
		High collar	17.4	22.3	44.5	<b>NME</b> ①

① **Abbreviations of colours:** ■ BK ■ GB ■ RD ■ GN □ WH ■ BL ■ GR  
 You append the abbreviations of the colours to the type designation.  
 For details of possible colour combinations, refer to the technical data on the previous page.

All dimensions in mm.

#### Key

A	Height	Height of command device in front of the front panel
B	Mounting-Ø	Installation diameter for the command device head
C	Key Ø	Width of command device head

# Command and signalling devices – N programme

## Pushbuttons and illuminated pushbuttons



■ NDT

■ NDL

### Key Features

<b>General description</b>	Pushbutton	Illuminated pushbutton
<b>Area of application</b>	Food, hygiene and outdoor applications	Food, hygiene and outdoor applications
<b>Mounting-Ø</b>	22.3 mm	22.3 mm
<b>Housing material</b>		
<b>Material of operating element</b>	ABS	PA (12)
<b>Material front ring</b>	ABS, chrome-plated	ABS, chrome-plated

### Technical features

<b>Mechanical data</b>		
<b>Colour of the operating element</b>		
<b>Colour of seal</b>		
<b>Design</b>	round	round
<b>Front panel thickness</b>	1...6 mm	1...6 mm
<b>Mounting</b>		
<b>Mounting flange included in delivery</b>	■	■
<b>Mounting position</b>	any	any
<b>Ambient conditions</b>		
<b>Ambient temperatures</b>	-25 °C ... +80 °C	-25 °C ... +80 °C
<b>IP Protection class</b>	IP69K	IP69K

### Safety classification

<b>Standards</b>	IEC 60947-5-1; IEC 60947-1	IEC 60947-5-1; IEC 60947-1
<b>Mechanical life</b>	1,000,000 operations	1,000,000 operations
<b>Certificates</b>		
<b>Note</b>	cULus in conjunction with the corresponding contact elements only	



# Command and signalling devices – N programme

## Pushbuttons and illuminated pushbuttons

Type	Description		A	B	C	Type designation
Pushbutton	Hygiene application	"White" bellows	11	22.3	44.5	<b>NDT</b> ①
	Outdoor usage	Black "bellows"	11	22.3	44.5	<b>NDTGR</b> ①
Illuminated pushbutton	Hygiene application	"White" bellows	11	22.3	44.5	<b>NDL</b> ①
	Outdoor usage	Black "bellows"	11	22.3	44.5	<b>NDLGR</b> ①

① **Abbreviations of colours:**  BK  GB  RD  GN  WH  BL  GR  
 You append the abbreviations of the colours to the type designation.  
 For details of possible colour combinations, refer to the technical data on the previous page.

All dimensions in mm.

### Key

A	Height	Height of command device in front of the front panel
B	Mounting-Ø	Installation diameter for the command device head
C	Key Ø	Width of command device head

# Command and signalling devices – N programme

## Mushroom head impact button



■ NDP

■ NDR

### Key Features

<b>General description</b>	Mushroom button without latching function	Mushroom button with latching function
<b>Area of application</b>	Food, hygiene and outdoor applications	Food, hygiene and outdoor applications
<b>Mounting-Ø</b>	22.3 mm	22.3 mm
<b>Housing material</b>		
<b>Material of operating element</b>	Thermoplastic	Thermoplastic
<b>Material front ring</b>	ABS, chrome-plated	ABS, chrome-plated

### Technical features

<b>Mechanical data</b>		
<b>Colour of the operating element</b>		
<b>Colour of sealing membranes</b>		
<b>Design</b>	round	round
<b>Front panel thickness</b>	1...6 mm	1...6 mm
<b>With latching</b>	-	■
<b>Mounting</b>		
<b>Mounting flange included in delivery</b>	■	■
<b>Mounting position</b>	any	any
<b>Ambient conditions</b>		
<b>Ambient temperatures</b>	-25 °C ... +80 °C	-25 °C ... +80 °C
<b>IP Protection class</b>	IP69K	IP69K

### Safety classification

<b>Standards</b>	IEC 60947-5-1; IEC 60947-1	IEC 60947-5-1; IEC 60947-1
<b>Mechanical life</b>	1,000,000 operations	1,000,000 operations
<b>Certificates</b>		
<b>Note</b>	cULus in conjunction with the corresponding contact elements only	

# Command and signalling devices – N programme

## Mushroom head impact button

Type	Description	A	B	C	Type designation	
<b>Mushroom head impact button</b>	Without latching	"White" bellows	45	22.3	50	<b>NDP50</b> ①
		Black "bellows"	45	22.3	50	<b>NDP50GR</b> ①
	With integrated latching	"White" bellows	45	22.3	50	<b>NDRZ50</b> ①
		Black "bellows"	45	22.3	50	<b>NDRZ50GR/</b> ①
	With latching via spring element EFR*	"White" bellows	45	22.3	50	<b>NDRR50</b> ①
		Black "bellows"	45	22.3	50	<b>NDRR50GR/</b> ①

\* Spring element EFR must be ordered separately.

① **Abbreviations of colours:**  BK  GB  RD  GN  WH  BL  GR

You append the abbreviations of the colours to the type designation.  
For details of possible colour combinations, refer to the technical data on the previous page.

All dimensions in mm.

### Key

A	Height	Height of command device in front of the front panel
B	Mounting-Ø	Installation diameter for the command device head
C	Key Ø	Width of command device head

## Command and signalling devices – N programme

### Maintained selector switches and spring return selector switches



■ NWS / NWT

■ NWS .1 / NWT .1



#### Key Features

<b>General description</b>	Selector switches/spring-return selector switches with short toggle	Selector switches/spring-return selector switches with long toggle
<b>Area of application</b>	Food, hygiene and outdoor applications	Food, hygiene and outdoor applications
<b>Mounting-Ø</b>	22.3 mm	22.3 mm
<b>Toggle length</b>	33 mm	46 mm
<b>Housing material</b>		
<b>Material of operating element</b>	Thermoplastic	Thermoplastic
<b>Material front ring</b>	ABS, chrome-plated	ABS, chrome-plated

#### Technical features







<b>Mechanical data</b>		
<b>Colour of the operating element</b>	<input type="checkbox"/> <input checked="" type="checkbox"/>	<input type="checkbox"/> <input checked="" type="checkbox"/>
<b>Colour of seal</b>	<input type="checkbox"/> <input checked="" type="checkbox"/>	<input type="checkbox"/> <input checked="" type="checkbox"/>
<b>Design</b>	round	round
<b>Front panel thickness</b>	1...6 mm	1...6 mm
<b>Mounting</b>		
<b>Mounting flange included in delivery</b>	<input checked="" type="checkbox"/>	<input checked="" type="checkbox"/>
<b>Mounting position</b>	any	any
<b>Ambient conditions</b>		
<b>Ambient temperatures</b>	0 °C ... +80 °C	0 °C ... +80 °C
<b>IP Protection class</b>	IP69K	IP69K

#### Safety classification

<b>Standards</b>	IEC 60947-5-1; IEC 60947-1	IEC 60947-5-1; IEC 60947-1
<b>Mechanical life</b>	300,000 operations	300,000 operations
<b>Certificates</b>		
<b>Note</b>	cULus in conjunction with the corresponding contact elements only	

## Command and signalling devices – N programme

### Maintained selector switches and spring return selector switches

Type	Maintained and momentary positions	Positions	Actuator	A	B	C	Type designation
Selector switch	2 maintained positions		Short toggle	26	22.3	44.5	NWS21 ①
			Long toggle	26	22.3	44.5	NWS21.1 ①
	3 maintained positions		Short toggle	26	22.3	44.5	NWS32 ①
			Long toggle	26	22.3	44.5	NWS32.1 ①
Spring-return selector switch	1 momentary position and automatic return to the zero position		Short toggle	26	22.3	44.5	NWT21 ①
			Long toggle	26	22.3	44.5	NWT21.1 ①
	1 momentary position each to the right and left of the zero position		Short toggle	26	22.3	44.5	NWT32 ①
			Long toggle	26	22.3	44.5	NWT32.1 ①
Maintained spring-return rotary selector switch	1 momentary position on the right and 2 maintained positions		Short toggle	26	22.3	44.5	NWTS32 ①
			Long toggle	26	22.3	44.5	NWTS32.1 ①
	1 momentary position on the left and 2 maintained positions		Short toggle	26	22.3	44.5	NWTS321 ①
			Long toggle	26	22.3	44.5	NWTS321.1 ①

① Abbreviation of colour:  WH

If you want a white toggle, append "WH" to the type designation.

All dimensions in mm.

#### Key

A	Height	Height of command device in front of the front panel
B	Mounting-Ø	Installation diameter for the command device head
C	Key Ø	Width of command device head

# Command and signalling devices – N programme

## Main switches



■ NHS16/2-pol



■ NHS40



■ NHS63

### Key Features

<b>General description</b>	Main switches 16A	Main switches 40A	Main switches 63A
<b>Area of application</b>	Food, hygiene and outdoor applications	Food, hygiene and outdoor applications	Food, hygiene and outdoor applications
<b>Mounting</b>	Ø 22.3 mm	110 x 110 mm or Ø 22.3 mm	110 x 110 mm or Ø 22.3 mm
<b>Housing material</b>			
<b>Material of operating element</b>	Thermoplastic	Thermoplastic	Thermoplastic
<b>Material front ring</b>	ABS, chrome-plated	ABS, chrome-plated	ABS, chrome-plated







### Other designs are available

<b>EMERGENCY STOP design</b>	■	■	■
------------------------------	---	---	---

### Technical features

<b>Mechanical data</b>			
<b>Colour of the operating element</b>	■ ■	■ ■	■ ■
<b>Colour of seal</b>	■	■	■
<b>Design</b>	round	Square	Square
<b>Front panel thickness</b>	1...6 mm	1...6 mm	1...6 mm
<b>Maintained switching positions</b>	2 positions	2 positions	2 positions
<b>Mounting</b>			
<b>Mounting flange incl. in delivery</b>	-	-	-
<b>Integrated mounting plate</b>	■	■	■
<b>Mounting position</b>	any	any	any
<b>Ambient temperatures</b>			
<b>open</b>	-25 °C ... +50 °C	-25 °C ... +50 °C	-25 °C ... +50 °C
<b>Enclosed</b>	-25 °C ... +40 °C	-25 °C ... +40 °C	-25 °C ... +40 °C
<b>IP Protection class</b>	IP69K	IP69K	IP69K

### Safety classification

<b>Standards</b>	IEC EN 60947, IEC EN 60204; UL 508; CSA22.2 No. 14	IEC EN 60947, IEC EN 60204; UL 508; CSA22.2 No. 14	IEC EN 60947, IEC EN 60204; UL 508; CSA22.2 No. 14
<b>Mechanical life</b>	1,000,000 operations	100,000 operations	100,000 operations
<b>Certificates</b>	 	 	 

# Command and signalling devices – N programme

## Main switches

Type	Series	Description	A	B	C	Type designation	Material number
Main switches	NHS16	16 A, 2-pole Standard	29	22.3	70 x 80	NHS16/2-POL	101204196
		EMERGENCY STOP With red grip + yellow background	29	22.3	Ø 100	NHSNH16/2-POL	101209839
	NHS16	16 A, 4-pole Standard	29	22.3	70 x 80	NHS16/4-POL	103002746
		EMERGENCY STOP With red grip + yellow background	29	22.3	Ø 100	NHSNH16/4-POL	103002747
	NHS40	40 A, 3-pole Standard	29	22.3	110 x 110	NHS40	101185098
		EMERGENCY STOP With red grip + yellow background	29	22.3	110 x 110	NHSNH40	101185097
	NHS63	63 A, 3-pole Standard	29	22.3	110 x 110	NHS63	101184920
		EMERGENCY STOP With red grip + yellow background	29	22.3	110 x 110	NHSNH63	101184919

All dimensions in mm.

### Key

A	Height	Height of command device in front of the front panel
B	Mounting-Ø	Installation diameter for the command device head
C	Panel size	Dimensions of panel (if present)

# Command and signalling devices – N programme

## Special devices



■ NWSE..K

■ NDAN6

### Key Features

<b>General description</b>	Step selector switch	Potentiometer drive
<b>Area of application</b>	Food, hygiene and outdoor applications	Food, hygiene and outdoor applications
<b>Mounting-Ø</b>	22.3 mm	22.3 mm
<b>Housing material</b>		
<b>Material of operating element</b>	Thermoplastic	Thermoplastic
<b>Material front ring</b>	ABS, chrome-plated	ABS, chrome-plated

### Technical features

<b>Electrical data</b>		
<b>Cam-operated switch</b>	Kraus & Naimer Series CA10	–
<b>Contacts</b>	One NO contact per stage	–
<b>Insulation voltage <math>U_i</math></b>	690V	–
<b>Utilisation category AC-15</b>	220 V...240 V / 5 A, 380 V...440 V / 4 A	–
<b>Rated impulse withstand voltage. <math>U_{imp}</math></b>	6 kV	–
<b>Rated continuous current <math>I_{the}</math></b>	20 A	–
<b>Fuse rating</b>	gG 25 A	–
<b>Cable section</b>	max. 2 x 2.5 mm <sup>2</sup> *	–
<b>Mechanical data</b>		
<b>Colour</b>		
<b>Operating element</b>		
<b>Front ring</b>	Silver	Silver
<b>Front panel thickness</b>	1 ... 6 mm	1 ... 6 mm
<b>Maintained switching positions</b>	3 ... 12 positions	Infinite
<b>Mounting</b>		
<b>Integrated mounting plate</b>		
<b>Mounting position</b>	any	any
<b>Ambient conditions</b>		
<b>Ambient temperatures</b>	0 °C ... +60 °C	0 °C ... +75 °C
<b>IP protection class (device head)</b>	IP69K	IP69K

### Safety classification

<b>Standards</b>	IEC 60947-3 (VDE 0660 Part 107)	–
<b>Mechanical life</b>	Load-dependent	–
<b>Certificates</b>		

\* Use copper conductors only



# Command and signalling devices – N programme

## Special devices

Type	Circuit diagram and connecting terminals	Switching angle	L	LE	A	B	C	Type designation
Cam switching design step switches with latching mechanism, 1-pole no zero position		60°	40.7	60	26	22.3	44.5	NWSE3K
		60°	40.7	60	26	22.3	44.5	NWSE4K
		60°	50.2	69.5	26	22.3	44.5	NWSE5K
		60°	50.2	69.5	26	22.3	44.5	NWSE6K
		45°	59.7	78	26	22.3	44.5	NWSE7K
		45°	59.7	78	26	22.3	44.5	NWSE8K
		30°	69.2	87.5	26	22.3	44.5	NWSE9K
		30°	69.2	87.5	26	22.3	44.5	NWSE10K
		30°	78.7	97	26	22.3	44.5	NWSE11K
		30°	78.7	97	26	22.3	44.5	NWSE12K

Type	Description	LE	A	B	C	Type designation
Potentiometer drive	for 6 mm shaft Ø, shaft length 30 ... 40 mm	63	26	22.3	44.5	NDAN6

All dimensions in mm.

### Key

A	Height	Height of command device in front of the front panel
B	Mounting-Ø	Installation diameter for the command device head
C	Key Ø	Width of command device head
L	Length	Length of step switch block
LE	Installation depth	Length between command device head and bottom edge of switch when mounted

# Command and signalling devices

## "R" program

### Area of application

When designing control panels on machines that will be working under particularly harsh conditions, it is advisable to use the R product portfolio. The "R" stands for "robust", which represents the main feature of this switchgear.

### Design and way of functioning

Both the mechanical systems and the electrical components are of heavy-duty design. The R series is resistant to mechanical loading and you can also operate -it easily when wearing gloves. The use of an adapter ring makes it possible to easily mount series R devices in a 30.5 mm installation diameter without needing additional sealing on the front panel of the machine to seal the installation hole..

The contact system (see page 64) that Schmersal developed has also been designed for a long service life under heavy loading. In the same way as with the E and N product portfolios, users can choose from a wide range of different command devices and indicator lights.

If desired, we can supply command devices pre-wired and pre-assembled in the enclosure. An ATEX-compliant version of the R series is also available.

Program-Overview		Page
1	EMERGENCY STOP	44
2	Pushbutton	48
3	Mushroom head impact button/ EMERGENCY STOP pushbutton	50
4	Selector switch/key button	52
5	Key-operated selector switch/button	54
6	Illuminated pushbutton	48
7	Illuminated signal	46
8	Step selector switch	56
9	Potentiometer drive	56
10	Mounting flange *	RLM *
11	Contact carrier *	
12	Plunger elements *	
13	Contact elements RF...	64
14	Light terminal block RLDE...	64
15	Light terminal block RL...	65
16	EMERGENCY STOP label	66
17	EMERGENCY STOP protective collar	66
18	EMERGENCY STOP enclosure for surface mounting	70
19	Identification label	66
20	Stainless steel enclosure for surface mounting	70
21	Adapter ring	68
22	Blanking plug	66
23	Mounting tool	68

\* The RLM mounting flange consists of a mounting flange (10), a contact carrier (11) and 2 plunger elements (12).



# Command and signalling devices – R programme

## EMERGENCY STOP control devices



■ RDRZ45RT

### Key Features

General description	EMERGENCY STOP - with pull-to-unlatch mechanism
Area of application	Heavy-duty applications
Mounting-Ø	22.3 mm
Housing material	
Material of operating element	Aluminium
Material front ring	Aluminium

### Other designs are available

ATEX design	■
-------------	---

### Technical features

Mechanical data	
Colour of the operating element	■
Design	round
Front panel thickness	1...6 mm
Unlocking type	Pull-to-unlatch mechanism
Snap-action mechanism	
Integrated	■
Externally via additional module	-
Mounting	
Mounting flange included in delivery	■
Mounting position	any
Ambient conditions	
Ambient temperatures	-25 °C ... +75 °C
IP Protection class	IP65

### Safety classification

Standards	IEC 60947-5-1; IEC 60947-5-5; IEC 60947-1; EN ISO 13850
Mechanical life	100,000 operations
Certificates	
Note	cULus in conjunction with the corresponding contact elements only

## Command and signalling devices – R programme

### EMERGENCY STOP control devices

Type	Unlocking	Snap-action mechanism	A	B	C	Type designation	Material number
<b>EMERGENCY STOP command device</b>	Pull-to-unlatch mechanism	Integrated	27.5	22.3	45	<b>RDRZ45RT</b>	<b>101193576</b>

All dimensions in mm.

#### Key

A	Height	Height of command device in front of the front panel
B	Mounting-Ø	Installation diameter for the command device head
C	Key Ø	Width of command device head

# Command and signalling devices – R programme

## Illuminated signal



■ RMLF/RMLH



■ RMEF/RMEH

### Key Features

<b>General description</b>	Illuminated signal for BA9s	Illuminated signal with integrated LED
<b>Area of application</b>	Heavy-duty applications	Heavy-duty applications
<b>Mounting-Ø</b>	22.3 mm	22.3 mm
<b>Housing material</b>		
<b>Material of operating element</b>	Glass / PA (12)	Glass / PA (12)
<b>Material front ring</b>	Aluminium	Aluminium

### Other designs are available

<b>ATEX design</b>	■	-
--------------------	---	---

### Technical features

<b>Mechanical data</b>		
<b>Colour</b>		
<b>Design</b>	Round with flat or high glass	Round with flat or high glass
<b>Front panel thickness</b>	1...6 mm	1...6 mm
<b>Integrated LED 24 VAC/DC *</b>	-	■
<b>Mounting</b>		
<b>Mounting flange included in delivery</b>	■	■
<b>Mounting position</b>	any	any
<b>Ambient conditions</b>		
<b>Ambient temperatures</b>	-25 °C ... +75 °C	-25 °C ... +40 °C
<b>IP Protection class</b>	IP65	IP65

### Safety classification

<b>Standards</b>	IEC 60947-5-1; IEC 60947-1	IEC 60947-5-1; IEC 60947-1
<b>Mechanical life</b>	-	-
<b>Certificates</b>		
<b>Note</b>	cULus in conjunction with the corresponding contact elements only	

\* A voltage sensor, e.g. an RE is also needed for driving. You can find the voltage sensors on page 58

# Command and signalling devices – R programme

## Illuminated signal

Type	Description		A	B	C	Type designation
Illuminated signal	Without integrated illuminant	Flat collar	11	22.3	39.5	RML ①
		High collar	21.5	22.3	39.5	RMLH ①
LED indicator light	With integrated illuminant	Flat collar	11	22.3	39.5	RMEF ①
		High collar	21.5	22.3	39.5	RMEH ①

① **Abbreviations of colours:** ■ BK ■ GB ■ RD ■ GN □ WH ■ BL ■ GR  
 You append the abbreviations of the colours to the type designation.  
 For details of possible colour combinations, refer to the technical data on the previous page.

All dimensions in mm.

### Key

- A Height Height of command device in front of the front panel
- B Mounting-Ø Installation diameter for the command device head
- C Key Ø Width of command device head

# Command and signalling devices – R programme

## Pushbuttons and illuminated pushbuttons



■ RDT

■ RDL

### Key Features

<b>General description</b>	Pushbutton	Illuminated pushbutton
<b>Area of application</b>	Heavy-duty applications	Heavy-duty applications
<b>Mounting-Ø</b>	22.3 mm	22.3 mm
<b>Housing material</b>		
<b>Material of operating element</b>	Aluminium	Glass
<b>Material front ring</b>	Aluminium	Aluminium

### Other designs are available

<b>ATEX design</b>	■	■
--------------------	---	---

### Technical features

<b>Mechanical data</b>		
<b>Colour</b>		
<b>Design</b>	round	round
<b>Front panel thickness</b>	1...6 mm	1...6 mm
<b>Mounting</b>		
<b>Mounting flange included in delivery</b>	■	■
<b>Mounting position</b>	any	any
<b>Ambient conditions</b>		
<b>Ambient temperatures</b>	-25 °C ... +75 °C	-25 °C ... +75 °C
<b>IP Protection class</b>	IP65	IP65

### Safety classification

<b>Standards</b>	IEC 60947-5-1; IEC 60947-1	IEC 60947-5-1; IEC 60947-1
<b>Mechanical life</b>	10,000,000 operations	10,000,000 operations
<b>Certificates</b>		
<b>Note</b>	cULus in conjunction with the corresponding contact elements only	



## Command and signalling devices – R programme

### Pushbuttons and illuminated pushbuttons

Type	Description	A	B	C	Type designation
Pushbutton	Standard	11	22.3	39.5	<b>RDT</b> ①
	With membrane	11	22.3	39.5	<b>RDM</b> ①
Illuminated pushbutton	Standard	11	22.3	39.5	<b>RDL</b> ①
	With membrane	11	22.3	39.5	<b>RDLM</b> ①

① **Abbreviations of colours:** ■ BK ■ GB ■ RD ■ GN □ WH ■ BL ■ GR

You append the abbreviations of the colours to the type designation.  
For details of possible colour combinations, refer to the technical data on the previous page.

All dimensions in mm.

#### Key

A	Height	Height of command device in front of the front panel
B	Mounting-Ø	Installation diameter for the command device head
C	Key Ø	Width of command device head

# Command and signalling devices – R programme

## Mushroom head impact button



■ RDP40



■ RDRZ45

### Key Features

<b>General description</b>	Mushroom button without latching function	Mushroom button with latching function
<b>Area of application</b>	Heavy-duty applications	Heavy-duty applications
<b>Mounting-Ø</b>	22.3 mm	22.3 mm
<b>Housing material</b>		
<b>Material of operating element</b>	Aluminium	Aluminium
<b>Material front ring</b>	Aluminium	Aluminium

### Other designs are available

<b>ATEX design</b>	■	■
--------------------	---	---

### Technical features

<b>Mechanical data</b>		
<b>Colour</b>		
<b>Design</b>	round	round
<b>Front panel thickness</b>	1...6 mm	1...6 mm
<b>With latching</b>	-	■
<b>Mounting</b>		
<b>Mounting flange included in delivery</b>	■	■
<b>Mounting position</b>	any	any
<b>Ambient conditions</b>		
<b>Ambient temperatures</b>	-25 °C ... +75 °C	-25 °C ... +75 °C
<b>IP Protection class</b>	IP65	IP65

### Safety classification

<b>Standards</b>	IEC 60947-5-1; IEC 60947-1	IEC 60947-5-1; IEC 60947-1
<b>Mechanical life</b>	10,000,000 operations	10,000,000 operations
<b>Certificates</b>		
<b>Note</b>	cULus in conjunction with the corresponding contact elements only	

## Command and signalling devices – R programme

### Mushroom head impact button

Type	Description		A	B	C	Type designation
Mushroom head impact button	without latching	Mushroom-shaped	27	22.3	39.5	RDP40 ①
	with latching	Mushroom-shaped	27	22.3	45	RDRZ45 ①

① **Abbreviations of colours:** ■ BK ■ GB ■ RD ■ GN □ WH ■ BL  
 You append the abbreviations of the colours to the type designation.  
 For details of possible colour combinations, refer to the technical data on the previous page.

All dimensions in mm.

#### Key

A	Height	Height of command device in front of the front panel
B	Mounting-Ø	Installation diameter for the command device head
C	Key Ø	Width of command device head

## Command and signalling devices – R programme

### Maintained selector switches and spring return selector switches



■ RWS / RWT

■ RWS .1 / RWT .1

#### Key Features

<b>General description</b>	Selector switches/spring-return selector switches with short toggle	Selector switches/spring-return selector switches with long toggle
<b>Area of application</b>	Heavy-duty applications	Heavy-duty applications
<b>Mounting-Ø</b>	22.3 mm	22.3 mm
<b>Toggle length</b>	40 mm	49 mm
<b>Housing material</b>		
<b>Material of operating element</b>	Thermoplastic	Thermoplastic
<b>Material front ring</b>	Aluminium	Aluminium



#### Other designs are available

<b>ATEX design</b>	■	■
--------------------	---	---

#### Technical features







<b>Mechanical data</b>		
<b>Colour</b>	■	■
<b>Design</b>	round	round
<b>Front panel thickness</b>	1...6 mm	1...6 mm
<b>Maintained switching positions</b>	2...3 positions	2...3 positions
<b>Mounting</b>		
<b>Mounting flange included in delivery</b>	■	■
<b>Mounting position</b>	any	any
<b>Ambient conditions</b>		
<b>Ambient temperatures</b>	0 °C ... +75 °C	0 °C ... +75 °C
<b>IP Protection class</b>	IP65	IP65

#### Safety classification

<b>Standards</b>	IEC 60947-5-1; IEC 60947-1	IEC 60947-5-1; IEC 60947-1
<b>Mechanical life</b>	300,000 operations	300,000 operations
<b>Certificates</b>		
<b>Note</b>	cULus in conjunction with the corresponding contact elements only	

## Command and signalling devices – R programme

### Maintained selector switches and spring return selector switches

Type	Maintained and momentary positions	Positions	Actuator	A	B	C	Type designation
Selector switch	2 maintained positions		Short toggle	32	22.3	39.5	RWT21
			Long toggle	32	22.3	39.5	RWT21.1
	3 maintained positions		Short toggle	32	22.3	39.5	RWT32
			Long toggle	32	22.3	39.5	RWT32.1
Spring-return selector switch	1 momentary position and automatic return to the zero position		Short toggle	32	22.3	39.5	RWS21
			Long toggle	32	22.3	39.5	RWS21.1
	1 momentary position each to the right and left of the zero position		Short toggle	32	22.3	39.5	RWS32
			Long toggle	32	22.3	39.5	RWS32.1
Maintained spring-return rotary selector switch	1 momentary position on the right and 2 maintained positions		Short toggle	32	22.3	39.5	RWTS32
			Long toggle	32	22.3	39.5	RWTS32.1
	1 momentary position on the left and 2 maintained positions		Short toggle	32	22.3	39.5	RWTS321
			Long toggle	32	22.3	39.5	RWTS321.1

① **Toggle length:**

If you want a long toggle, append a "1" to the type designation.

All dimensions in mm.

**Key**

A	Height	Height of command device in front of the front panel
B	Mounting-Ø	Installation diameter for the command device head
C	Key Ø	Width of command device head

## Command and signalling devices – R programme

### Key selector switches, buttons and -touch contact switches



■ RSS

■ RST

#### Key Features

<b>General description</b>	Key-operated selector switch	Key-operated spring-return selector switch
<b>Area of application</b>	Heavy-duty applications	Heavy-duty applications
<b>Mounting-Ø</b>	22.3 mm	22.3 mm
<b>Housing material</b>		
<b>Material of operating element</b>	Aluminium	Aluminium
<b>Material front ring</b>	Aluminium	Aluminium



#### Other designs are available

<b>ATEX design</b>	-	-
--------------------	---	---

#### Technical features



<b>Mechanical data</b>		
<b>Colour</b>	Metal (silver)	Metal (silver)
<b>Design</b>	round	round
<b>Front panel thickness</b>	1...6 mm	1...6 mm
<b>Maintained switching positions</b>	2 or 3 positions	2 or 3 positions
<b>Mounting</b>		
<b>Mounting flange included in delivery</b>	■	■
<b>Mounting position</b>	any	any
<b>Ambient conditions</b>		
<b>Ambient temperatures</b>	0 °C ... +75 °C	0 °C ... +75 °C
<b>IP Protection class</b>	IP65	IP65

#### Safety classification

<b>Standards</b>	IEC 60947-5-1; IEC 60947-1	IEC 60947-5-1; IEC 60947-1
<b>Mechanical life</b>	300,000 operations	300,000 operations
<b>Certificates</b>		
<b>Note</b>	cULus in conjunction with the corresponding contact elements only	

## Command and signalling devices – R programme

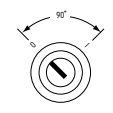
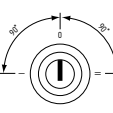
### Key selector switches, buttons and -touch contact switches

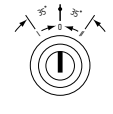
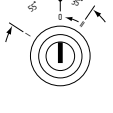
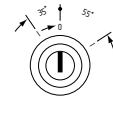
Type	Maintained and momentary positions	Positions	Key-withdrawal position	A	B	C	Type designation
Key-operated selector switch	2 maintained positions		O	31.5	22.3	39.5	RSS21S1
			I	31.5	22.3	39.5	RSS21S2
			O + I	31.5	22.3	39.5	RSS21S12
	3 maintained positions		I	31.5	22.3	39.5	RSS32S1
			O	31.5	22.3	39.5	RSS32S2
			II	31.5	22.3	39.5	RSS32S3
I + O + II			31.5	22.3	39.5	RSS32S123	
Key-operated spring-return selector switch	1 momentary position and automatic return to the zero position		O	31.5	22.3	39.5	RST21S1
	2 momentary positions on the right and left with automatic return to the zero position		O	31.5	22.3	39.5	RSTS32S2
Key-operated selector switch pushbutton	3 positions: momentary position 35° actuating angle and maintained position 55° actuating angle (zero position in middle, key position at top)		I	31.5	22.3	39.5	RSST32S1
			O	31.5	22.3	39.5	RSTS32S2
			O	31.5	22.3	39.5	RSTS321S2
			II	31.5	22.3	39.5	RSTS32S3

All dimensions in mm.

#### Key

- A Height Height of command device in front of the front panel without key
- B Mounting-Ø Installation diameter for the command device head
- C Key Ø Width of command device head

# Command and signalling devices – R programme

## Special devices



■ RWSE..K



■ RDAN6

### Key Features

<b>General description</b>	Step selector switch	Potentiometer drive
<b>Area of application</b>	Heavy-duty applications	Heavy-duty applications
<b>Mounting-Ø</b>	22.3 mm	22.3 mm
<b>Housing material</b>		
<b>Material of operating element</b>	Thermoplastic	Thermoplastic
<b>Material front ring</b>	Aluminium	Aluminium

### Other designs are available

<b>ATEX design</b>	-	-
--------------------	---	---

### Technical features

<b>Electrical data</b>		
<b>Cam-operated switch</b>	Kraus & Naimer Series CA10	-
<b>Contacts</b>	One NO contact per stage	-
<b>Insulation voltage <math>U_i</math></b>	690 V	-
<b>Utilisation category AC-15</b>	220 V ... 240 V / 5 A, 380 V ... 440 V / 4 A	-
<b>Rated impulse withstand voltage. <math>U_{imp}</math></b>	6 kV	-
<b>Rated continuous current <math>I_{the}</math></b>	20 A	-
<b>Fuse rating</b>	gG 25 A	-
<b>Cable section</b>	max. 2 x 2.5 mm <sup>2</sup> *	-
<b>Mechanical data</b>		
<b>Colour</b>		
<b>Operating element</b>	■	■
<b>Front ring</b>	Silver	Silver
<b>Front panel thickness</b>	1 ... 6 mm	1 ... 6 mm
<b>Maintained switching positions</b>	3 ... 12 positions	Infinite
<b>Mounting</b>		
<b>Integrated mounting plate</b>	■	■
<b>Mounting position</b>	any	any
<b>Ambient conditions</b>		
<b>Ambient temperatures</b>	0 °C ... +60 °C	0 °C ... +75 °C
<b>IP protection class (device head)</b>	IP65	IP65

### Safety classification

<b>Standards</b>	IEC 60947-3 (VDE 0660 Part 107)	-
<b>Mechanical life</b>	Load-dependent	-
<b>Certificates</b>		-



# Command and signalling devices – R programme

## Special devices

Type	Circuit diagram and connecting terminals	Switching angle	L	LE	A	B	C	Type designation	Material number
Cam switching design step switches with latching mechanism, 1-pole no zero position		60°	40.7	60	32	22.3	54	RWSE3K.1	101195857
		60°	40.7	60	32	22.3	54	RWSE4K.1	101195858
		60°	50.2	69.5	32	22.3	54	RWSE5K.1	101195859
		60°	50.2	69.5	32	22.3	54	RWSE6K.1	101195860
		45°	59.7	78	32	22.3	54	RWSE7K.1	101195861
		45°	59.7	78	32	22.3	54	RWSE8K.1	101195862
		30°	69.2	87.5	32	22.3	54	RWSE9K.1	101195863
		30°	69.2	87.5	32	22.3	54	RWSE10K.1	101195864
		30°	78.7	97	32	22.3	54	RWSE11K.1	101195865
		30°	78.7	97	32	22.3	54	RWSE12K.1	101195866

Type	Description	LE	A	B	C	Type designation
Potentiometer drive	for 6 mm shaft Ø, shaft length 30 ... 40 mm	63	31	22.3	39.5	RDAN6

All dimensions in mm.

### Key

A	Height	Height of command device in front of the front panel
B	Mounting-Ø	Installation diameter for the command device head
C	Key Ø	Width of command device head
L	Length	Length of step switch block
LE	Installation depth	Length between command device head and bottom edge of switch when mounted

# Command and signalling devices

## Contact and lighting elements

### Area of application

The Schmersal Group has developed its own contact systems for series E, N and R command and signalling devices, which guarantee exceptional contacting even under the harshest ambient conditions.

### Design and way of functioning

All the elements of the EF system have a special low-voltage-capable and self-cleaning four-way contact bridge system. This is a twin contact bridge that works in-parallel as well as crosswise. In this way, the fixed contact and the moveable contact bridge always achieve several contacts. This ensures high levels of contact security that is enhanced by the shape of the fixed contacts. Apart from this, the contacts have a self-cleaning function that removes oxide and dirt particles before they are deposited and are able to affect operation of the switchgear.

The EF contact system can be supplied in four terminations:

- Screw terminals
- Cage clamp
- Blade terminal
- Direct mounting on PCB

The RF contact system is used with series R command devices. It is particularly user-friendly to install, since the RF contact system's -mounting flange comprises two parts and allows users to pre-mount the contact elements whereas the other part is used to fasten the device head and to later attach the contact carrier. With this contact system, users have a free choice of contacts, since the contact elements can be mounted on two levels.

## EF contact elements

Principle design of EF contact elements

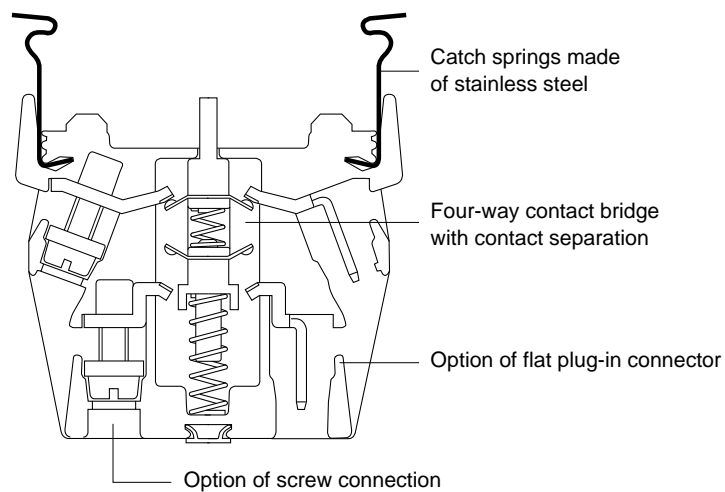

## Four-way contact bridge

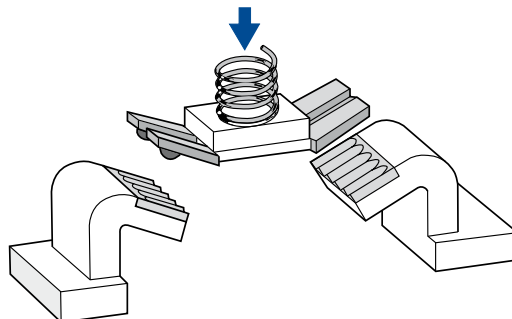

The electrical way of working of the contact elements is based on the Elan four-way contact. This is a twin contact bridge that works in-parallel as well as crosswise. The high contact security that is provided due to several contactings by the fixed contact and the moveable contact bridge is enhanced for industrial practice by the fixed contacts being angled and being embossed several times. The self-cleaning feature of the contacts reliably removes any oxide or dirt particles that may be produced due to operation at extra-low voltages.

# Contact and lighting elements

## Technical data



■ EF

■ EL / ELE

### Key Features

<b>General description</b>	Contact elements	Light terminal block with Ba9S base
<b>Can be used with</b>	E and N product portfolios	E and N product portfolios

### Other designs are available

<b>ATEX design</b>	-	-
--------------------	---	---

### Technical features

Design	EF	EL
<b>Material</b>		
<b>Material of the enclosure</b>	Plastic, glass-fibre-reinforced, self-extinguishing	Plastic, glass-fibre-reinforced, self-extinguishing
<b>Material of the contacts</b>	Fine-silver, phosphor bronze or brass carrier	-
<b>Utilisation category AC-15; DC-13</b>	250 V / 8 A; 24 V / 5 A	-
<b>Suitability for low voltages</b>	> 5 VDC / 3.2 mA	-
<b>Rated insulation voltage <math>U_i</math></b>	400 V	-
<b>Rated impulse withstand voltage. <math>U_{imp}</math></b>	4 kV	-
<b>Thermal test current <math>I_{the}</math></b>	10 A	-
<b>Max. fuse rating</b>	gG 10 A	Depending on version
<b>Switching frequency</b>	1200 s/h	-
<b>Mechanical life</b>	10,000,000 operations	-
<b>Resistance to shock</b>	110 g/4 ms...30 g/18 ms no bouncing	-
<b>Resistance to vibration</b>	> 20 g / 10 ... 200 Hz *	-
<b>Ambient temperature</b>	-25 °C ... +80 °C	-25 °C ... +80 °C
<b>Connection</b>		
<b>Screw terminals</b>	Yes	Yes
<b>Flat plug-in connector</b>	Yes	depending on the version
<b>Cage clamp connection</b>	Yes	depending on the version
<b>Cable section</b>		
<b>Solid wire</b>	2 x (0.5 ... 2.5 mm <sup>2</sup> )	2 x (0.5 ... 2.5 mm <sup>2</sup> )
<b>Stranded wire</b>	2 x (0.5 ... 1.5 mm <sup>2</sup> )	2 x (0.5 ... 1.5 mm <sup>2</sup> )
<b>Blade terminal</b>	6,3 mm x 0.8 mm / 2 x 2.8 mm x 0.8 mm	6,3 mm x 0.8 mm / 2 x 2.8 mm x 0.8 mm
<b>IP of terminals** /switch rooms</b>	IP20 / IP40	IP20 / -

### Safety classification

<b>Standards</b>	IEC 60947-5-1; IEC 60947-1	IEC 60947-5-1; IEC 60947-1
<b><math>B_{10d}</math></b>	100,000 operations	-
<b>Certificates</b>	 ***	 ***

\* For actuating heads with higher mass, appropriately lower

\*\* With plug-in connectors, depends on the connector plug used

\*\*\* Except for cage clamp connections



■ ELDE

■ RF

■ RL

■ RLDE

Light terminal block with LED E and N product portfolios	Contact elements "R" program	Light terminal block with Ba9S base "R" program	Light terminal block with LED "R" program
-	■	-	■

EL	RF	RL	RL
Plastic, glass-fibre-reinforced, self-extinguishing	Plastic, glass-fibre-reinforced, self-extinguishing	Plastic, glass-fibre-reinforced, self-extinguishing	Plastic, glass-fibre-reinforced, self-extinguishing
-	Fine-silver, phosphor bronze or brass carrier	-	-
-	250 V / 6 A; 24 V / 3 A	-	-
-	>5VDC / 1 mA	-	-
-	400 V	-	-
-	4 kV	-	-
-	6 A	-	-
Depending on version	gG 6 A	Depending on version	Depending on version
-	1200 s/h	-	-
-	10,000,000 operations	-	-
-	110 g/4 ms...30 g/18 ms no bouncing	-	-
-	> 20 g / 10 ... 200 Hz *	-	-
-25 °C ... +80 °C	-25 °C ... +75 °C	-25 °C ... +75 °C	-25 °C ... +75 °C
Yes	Yes	Yes	Yes
No	No	No	No
Yes	No	No	No
2 x (0.5 ... 2.5 mm <sup>2</sup> )	2 x (0.5 ... 2.5 mm <sup>2</sup> )	2 x (0.5 ... 2.5 mm <sup>2</sup> )	2 x (0.5 ... 2.5 mm <sup>2</sup> )
2 x (0.5 ... 1.5 mm <sup>2</sup> )	2 x (0.5 ... 1.5 mm <sup>2</sup> )	2 x (0.5 ... 1.5 mm <sup>2</sup> )	2 x (0.5 ... 1.5 mm <sup>2</sup> )
6,3 mm x 0.8 mm / 2 x 2.8 mm x 0.8 mm	-	-	-
IP20 / -	IP20 / IP40	IP20 / -	IP20 / -

IEC 60947-5-1; IEC 60947-1	IEC 60947-5-1; IEC 60947-1	IEC 60947-5-1; IEC 60947-1	IEC 60947-5-1; IEC 60947-1
-	100,000 operations	-	-

# Contact and lighting elements

## Type EF and EL

Command device	Position 2	Mounting flange EFM Position 3	Position 1
EMERGENCY STOP	Contact element EF...	Spring element EFR	Contact element EF...
Pushbutton	Contact element EF...	Contact element EF...	Contact element EF...
Mushroom head impact button			
Selector switch/key button			
Key-operated selector switch/button			

Command device	Position 2	Mounting flange ELM Position 3	Position 1
Illuminated pushbutton	Contact element EF...	Light terminal block EL...	Contact element EF...
Illuminated signal	---	Light terminal block EL...	---

### Design

A control and indicator device consists of an actuator, a mounting flange and a contact or light element (in the case of EMERGENCY STOP devices, possibly plus a spring element).

### Assembly example

This example shows an illuminated push button with ELM mounting flange, 2 EF... contact elements and an EL... lighting element

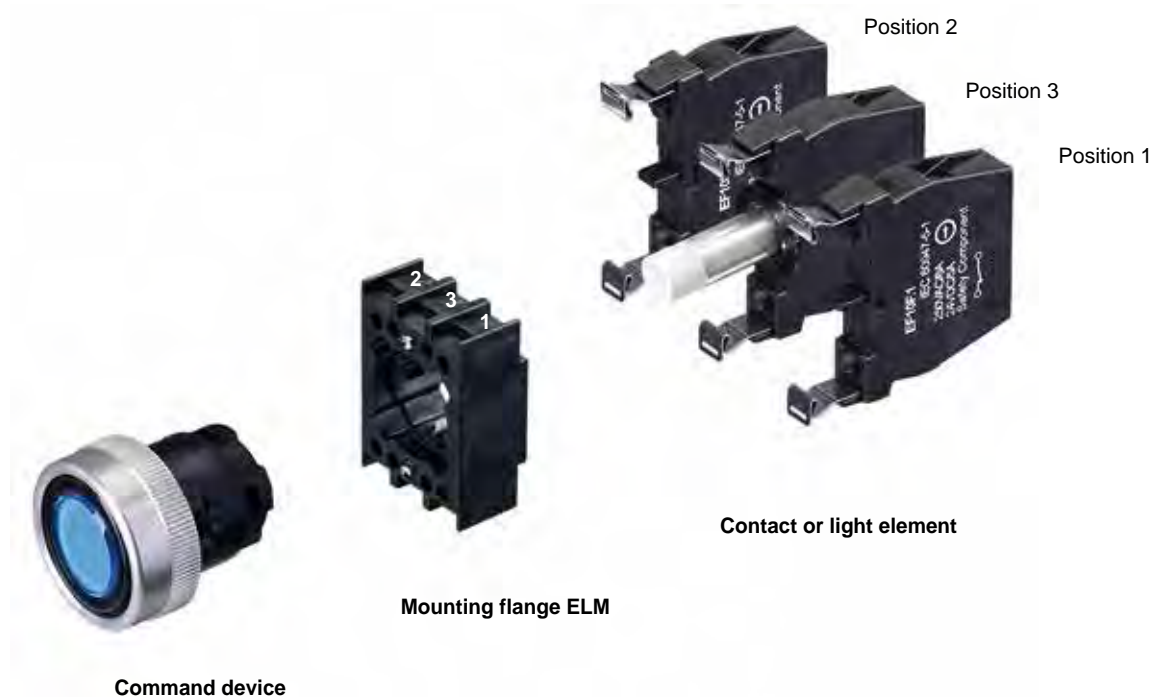

# Contact and lighting elements

## Type EF and EL

Type	Application	Function	Switch travel diagram	Position	Wiring configuration according to DIN 50005	Screw terminals	Flat plug-in connector	WAGO-Cage clamp	
Contact element	EMERGENCY STOP	2 NC contacts		1	11-12/21-22	EF220.1	EF220F.1	-	
				2	31-32/41-42	EF220.2	EF220F.2	-	
		1 NC contact / 1 NO contact		1	11-12/23-24	EF303.1	EF303F.1	-	
				2	31-32/43-44	EF303.2	EF303F.2	-	
	Standard	1 NC contacts			1	11-12	EF10.1	EF10F.1	EFK10.1
					2	21-22	EF10.2	EF10F.2	EFK10.2
					3	31-32	EF10.3	EF10F.3	EFK10.3
		1 NO contacts			1	13-14	EF03.1	EF03F.1	EFK03.1
					2	23-24	EF03.2	EF03F.2	EFK03.2
					3	33-34	EF03.3	EF03F.3	EFK03.3
		2 NO contacts			1	13-14/23-24	EF033.1	EF033F.1	EFK033.1
					2	33-34/43-44	EF033.2	EF033F.2	EFK033.2
					3	53-54/63-64	EF033.3	EF033F.3	-
		1 NC contact / 1 NO contact			1	11-12/23-24	EF103.1	EF103F.1	EF103.1
					2	31-32/43-44	EF103.2	EF103F.2	EF103.2
					3	51-52/63-64	EF103.3	EF103F.3	-
		1 NC contact / 1 NO contact overlapping			1	11-12/23-24	EF301.1	EF301F.1	-
					2	31-32/43-44	EF301.2	EF301F.2	-
			3	51-52/63-64	EF301.3	EF301F.3	-		

Type	Illuminant	Function	Diagram	Position	Description	Screw terminals	Flat plug-in connector	WAGO-Cage clamp
Light terminal block	Ba9S socket *	Lighting element / voltage sensor for lamps + acoustic signal		3	Standard	EL	ELF	-
				3	With transformer	ELT	ELTF	-
				3	With series resistor	ELV	ELVF	-
		Lighting element / voltage sensor for LED		3	24 VAC/DC	ELE	-	ELEK
				3	48 VAC/DC primary ... 24 V secondary	ELE 48	-	-
				3	115 ... 230 VAC primary 24 V secondary	ELE 230	-	-
	Integrated LED	Light element with integrated LED		3	LED red	ELDE.N RT 24	-	ELDEK RT
				3	LED yellow	ELDE.N GB 24	-	ELDEK GB
				3	LED green	ELDE.N GN 24	-	ELDEK GN
				3	LED blue	ELDE.N BL 24	-	ELDEK BL
3				LED white	ELDE.N WS 24	-	ELDEK WS	

Type	Application	Function	Position	Description	Screw terminals	Flat plug-in connector	WAGO-Cage clamp
EFR.EDRRS or EFR	EMERGENCY STOP	Snap-action mechanism with latching	3	Spring element	-	-	-

\* Illuminant not included in delivery!

# Contact and lighting elements

## Type RF and RL

Command device	Mounting flange RLM		
	Position 2	Position 1	Position 3
EMERGENCY STOP	Contact element RF...	Contact element RF...	Contact element RF...
Pushbutton			
Mushroom head impact button			
Selector switch/key button			
Key-operated selector switch/button			
Illuminated pushbutton	Contact element RF...	Light terminal block RL...	Contact element RF...
Illuminated signal	---	Light terminal block RL...	---

### Design

The contact bracket is for preassembling the RF contact elements or the RL or RLDE lighting elements.. The scope of supply of the fastening flange includes a mounting flange, a contact carrier and two plunger elements.

### Assembly example

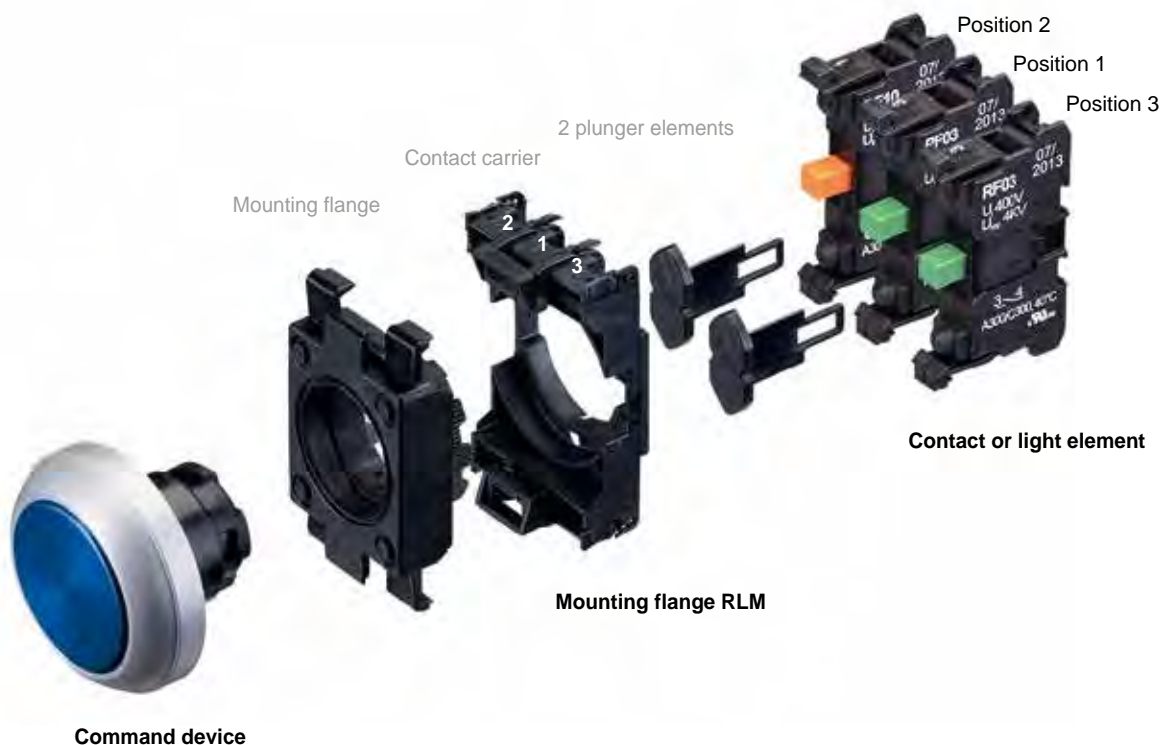

This example shows a mushroom button with an RLM mounting flange(comprising a mounting flange, a contact carrier and two plunger elements) and 3 RF03 contact elements





# Contact and lighting elements

## Type RF and RL

Type	Application	Function	Switch travel diagram	Position	Connection	Plunger colour	Contact labelling	Type designation
Contact element	Standard and EMERGENCY STOP	1 NC contacts		1, 2 and 3	Screw terminals	red	1, 2	<b>RF10</b>
							11, 12	<b>RF10.1</b>
		1 NO contacts		1, 2 and 3	Screw terminals	green	3, 4	<b>RF03</b>
							13, 14	<b>RF03.1</b>

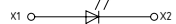
Type	Illuminant	Diagram	Position	Connection	Contact labelling	Type designation
Light terminal block	Ba9S socket *		3	Screw terminals	X1-X2	<b>RL</b>
	Integrated LED		3	Screw terminals	X1-X2	<b>RLDEWS24</b>

\* Illuminant not included in delivery!

# Command and signalling devices

## Accessories

Type	Description	Type designation	Recommended for programme		
			E	N	R
EMERGENCY STOP label	Installation Ø for 22.3 mm, 53 mm external Ø	MDP-8	■		■
	Installation Ø for 22.3 mm, 100 mm external Ø	MDP-6	■		■
	Installation Ø for 30.5 mm, 53 mm external Ø	DPF-9	■		■
	Installation Ø for 30.5 mm, 100 mm external Ø	DPF-7	■		■
	External Ø 70 mm, V4A version, colour yellow, self-adhesive, no labelling	NDP-70	■	■	■
	External Ø 65 mm plastic – as adhesive foil	NDP-65	■	■	■
Protective collar	EMERGENCY STOP protective collar, installation Ø for 22.3 mm operating element Ø 38.5 mm	EDRR-1 SET	■		
	EMERGENCY STOP protective collar, installation Ø for 22.3 mm operating element Ø 49 mm	EDRR-2 SET	■		■
	EMERGENCY STOP protective collar, installation Ø for 30.5 mm operating element Ø 38.5 mm	EDRR-1.1 SET	■		
	EMERGENCY STOP protective collar, installation Ø for 30.5 mm operating element Ø 49 mm	EDRR-2.1 SET	■		■
	EMERGENCY STOP protective collar, material 1.4550, incl. fastening screws	NSK/V4A/GB		■	
	Protective collar to prevent accidental touching for pushbuttons and illuminated pushbuttons	NSK-GR		■	
Selector switch lock	Selector switch lock for two-position selector switch	NWSP21GR		■	
	Selector switch lock for three-position selector switch	NWSP32GR		■	
Blanking plug	Blanking plug, metallized	NB		■	
	Blanking plug, stainless steel	NB/VA		■	
	Blanking plug, installation Ø 22.3 mm	BN	■		
	Blanking plug, installation Ø 30.5 mm	MBN	■		■
Identification label	Identification label, small	NZSO/V4A		■	
	Identification label, large	NZSO2/V4A		■	
	Identification label, small	RZSO			■
	Identification label, medium	RZSO1			■
	Identification label, large	RZSO2			■
	Identification label, aluminium	MZSO	■		
	Identification label, plastic	KZSO	■		
	Identification label, 30.5 mm, small	ZSO2	■		
	Identification label, 30.5 mm, large	ZSO	■		
Identification label, 30.5 mm, large	ZSNO	■			
Adapter ring	Adapter ring with gasket for using Ø 22 mm operating buttons to 30.5 mm drilled holes	NUE		■	
	Adapter ring with gasket for using Ø 22 mm operating buttons to 30.5 mm drilled holes	RUE			■
	Adapter ring with gasket for using Ø 22 mm operating buttons to 30.5 mm drilled holes	MUE	■		
Spare key	Spare key for key selector switch	SDS1/SDS2	■		■
mounting flange	mounting flange	EFM	■	■	-
	mounting flange	ELM	■	■	-
	Mounting flange for position switch	EFMH	■	■	
	mounting flange	RLM			■
	Driver for contact elements	R-F			■
Mounting tool	Mounting tool for mounting flange	RMW			■
Multi LED	Multi LED white Ba9S, 24 VDC	LE24/9WS	■	■	■
	Multi LED white Ba9S, 230 VDC	LE230/9WS	■	■	■
Lamp	Lamp 6V/2W	L6/9	■		■
	Lamp 12V/2W	L12/9	■		■
	Lamp 24V/1.9W	L24/9	■		■
	Lamp 30V/2W	L30/9	■		■
	Lamp 130V/2W	L130/9	■		■
Acoustic signal	Acoustic signal for EL voltage sensor, 24 VDC	EMES	■		

# Command and signalling devices

## Accessories

<p><b>EMERGENCY STOP label</b></p>  <ul style="list-style-type: none"> <li>■ NDP-70</li> <li>■ Material V4A</li> <li>■ Yellow powder-coated</li> </ul>	<p><b>EMERGENCY STOP protective collar</b></p>  <ul style="list-style-type: none"> <li>■ EDRR-1 SET</li> <li>■ Aluminium die-cast</li> <li>■ Yellow powder-coated</li> </ul>	<p><b>EMERGENCY STOP protective collar</b></p>  <ul style="list-style-type: none"> <li>■ NSK/V4A/GB</li> <li>■ Bracket material 1.4550 plate V4A powder-coated</li> </ul>
<p><b>Protective collar</b></p>  <ul style="list-style-type: none"> <li>■ NSK-GR</li> <li>■ Protective collar to prevent accidental touching</li> <li>■ For pushbuttons and illuminated N product portfolio pushbuttons and illuminated pushbuttons</li> <li>■ Command device not included in delivery</li> </ul>	<p><b>Selector switch lock</b></p>  <ul style="list-style-type: none"> <li>■ NWSP21GR / NWSP32GR</li> <li>■ Replacement measure for key-operated selector switch</li> <li>■ For selector switches with long toggle</li> <li>■ Padlock not included in the delivery</li> </ul>	<p><b>Blanking plug</b></p>  <ul style="list-style-type: none"> <li>■ NB</li> <li>■ Plastic, metallized</li> <li>■ For installation diameter 22.3 mm</li> </ul>
<p><b>Identification label</b></p>  <ul style="list-style-type: none"> <li>■ RZSO2</li> <li>■ Aluminium plate with black anodized labelling area</li> <li>■ Depending on version, 1 to 3 lines can be written</li> </ul>	<p><b>Identification label</b></p>  <ul style="list-style-type: none"> <li>■ NZSO...</li> <li>■ Stainless-steel plate V4A</li> <li>■ Depending on version, 1 to 3 lines can be written</li> </ul>	<p><b>Identification label</b></p>  <ul style="list-style-type: none"> <li>■ MZSO</li> <li>■ Aluminium plate with black anodized labelling area</li> </ul>

# Command and signalling devices

## Accessories

Adapter ring	Spare key	Mounting flange
 <ul style="list-style-type: none"> <li>■ RUE</li> <li>■ Plastic</li> <li>■ Adapter ring from installation diameter of 30.5 mm to 22.3 mm</li> </ul>	 <ul style="list-style-type: none"> <li>■ SDS1/SDS2</li> <li>■ Spare key for key selector switch with EKM locking</li> <li>■ Note: You must state the locking number too</li> </ul>	 <ul style="list-style-type: none"> <li>■ ELM</li> <li>■ Mounting flange for E and N product portfolio illuminated pushbuttons</li> </ul>
Mounting flange	Mounting flange	Mounting flange
 <ul style="list-style-type: none"> <li>■ EFM</li> <li>■ Mounting flange for E and N product portfolio pushbuttons</li> </ul>	 <ul style="list-style-type: none"> <li>■ EFMH</li> <li>■ Mounting flange for E and N product portfolio position switches</li> <li>■ Depending on the version, with position switch included in delivery too</li> </ul>	 <ul style="list-style-type: none"> <li>■ RLM</li> <li>■ Mounting flange for R product portfolio with contact carrier and driver</li> </ul>
Mounting tool	Multi LED	Acoustic signal
 <ul style="list-style-type: none"> <li>■ RMW</li> <li>■ Mounting tool for R product portfolio mounting flange</li> </ul>	 <ul style="list-style-type: none"> <li>■ LE24/9WS</li> <li>■ LED white</li> <li>■ For Ba9S socket</li> <li>■ 24VAC/DC</li> <li>■ Also available as 230V version</li> </ul>	 <ul style="list-style-type: none"> <li>■ EMES</li> <li>■ Acoustic signal for EL voltage sensor</li> <li>■ 24 VDC</li> </ul>

**Up-to-date without fail.**  
The online product catalogue



For detailed information, check out  
**[www.schmersal.net](http://www.schmersal.net)**

# Command and signalling devices

## Enclosure for surface mounting

### Enclosure MBG/ MBGH

These enclosures are made of solid cast alloy. This makes them appropriately robust and non-sensitive. Sealing of the enclosures has been designed so that the fastening screws are outside the gasket; this makes possible protection class IP65 without needing additional sealing of the fastening screws. A special EMERGENCY STOP enclosure with an integrated protective collar is available in this range that has been coordinated exactly with the EMERGENCY STOP command devices of product portfolios E and R. This protects the EMERGENCY STOP from being touched accidentally and offers plant owners the benefit of reducing undesirable downtimes.

### Enclosure MBGAC

Aluminium MBGAC series enclosures can be used on a very versatile basis due to their plain but functional design. They offer users the same robust features as MBG series enclosures. The MBGAC enclosures also have the same IP65 protection class as MBG ones. However, the tried and tested sealing concept has been applied here too.

### Enclosure MBK

MBK enclosures are manufactured from a very high-quality plastic. This allows users to deploy them under extreme conditions like temperatures of  $-40^{\circ}\text{C}$  to  $+100^{\circ}\text{C}$ ; in the same way, only a very few chemicals can endanger these enclosures. The fibreglass reinforcement in the plastic makes this small thermoplastic enclosure so extremely robust. Users have available two "knock-out" drilled holes for M20 cable glands to route cables in.

### Enclosure KG

The KG enclosures are simple ABS plastic ones for simple requirements that do not need a robust housing. The cable outlets are already mounted on these enclosures, which means that users only need to mount the command devices.

### Enclosure NBG/ EBG/ EX-EBG

Series NBG / EBG / EX-EBG assembly housings are made of high-quality stainless steel using a special deep-drawing process; they have been specially developed for hygiene and heavy-duty applications. The special ribbed gasket that surrounds the base of the enclosure on which the enclosure cover is forged on makes it possible to implement the particularly high IP 69K protection class. The EX-EBG enclosures have an additional integrated reinforcement panel that exceeds even the extreme requirements for explosion protection.

**MBG**



- Enclosure material, alloy

**MBGH**



- Enclosure material, alloy
- For EMERGENCY STOP with protective collar

**MBGAC**



- Enclosure material, alloy

**MBK**



- Enclosure material, plastic

**KG**



- Enclosure material, plastic

**NBG/EBG/EX-EBG**

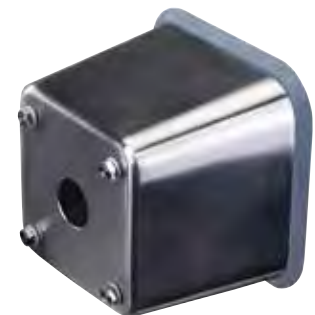

- Enclosure material, stainless steel

## Command and signalling devices

### Enclosure for surface mounting

Type	Description	Housing material	Number of drilled holes	Middle spacing of drilled holes (mm)	Length of enclosure (mm)
<b>MBG</b>	Assembly housing for EMERGENCY STOP	Alloy	1	–	85
			1	–	85
	Enclosure for surface mounting		1	–	85
			1	–	85
			2	30	125
			2	40	125
			2	50	165
			3	30	165
			3	40	165
			3	50	205
			4	30	205
			4	40	205
			4	50	245
			5	30	205
			5	40	245
			5	50	305
			6	30	245
			6	40	305
8	30	305			
<b>MBGAC</b>	Enclosure for surface mounting	Alloy	1	–	100
			3	40	160
			4	40	200
			5	40	245
			6	40	305
			2	50	160
			3	50	200
			4	50	245
			5	50	305
			<b>MBK</b>	For surface mounting	Thermoplastic
For EMERGENCY STOP	1	40		85	
<b>KG</b>	Enclosure for surface mounting	Thermoplastic	1	40	82
			1	40	82
			2	40	120
			2	40	120
			3	40	160
			3	40	160
			2	40	120
			2	40	120
			3	40	160
			3	40	160
<b>NBG/EBG</b>	Enclosure for surface mounting	Stainless steel	1	–	110
			0	–	154
			0	–	324
			2	60	154
			3	60	154
			4	60	324
			5	60	324
	5		65 / 55 / 55 / 55	324	
	Assembly housing for EMERGENCY STOP		3	54 / 50	154
			3	54 / 50	154
1		–	110		
Enclosure for surface mounting	3	60	154		
	5	60	324		
	5	60	324		
<b>EX-EBG</b>	Enclosure for surface mounting	Stainless steel	1	–	110
			3	60	154
			5	60	324



Width of enclosure (mm)	Height of enclosure (mm)	Drilled hole for cable gland	Type designation	Recommended command device range		
				"E" program	"N" program	"R" program
85	80	M20	MBG311GB	■		■
85	80	M20	MBGH311GB	■		■
85	80	M20	MBG311	■		■
85	80	M20	MBGH311	■		■
85	80	M20	MBG322	■		
85	80	M20	MBG422	■		■
85	80	M20	MBG532	■		■
85	80	M20	MBG333	■		
85	80	M20	MBG433	■		■
85	80	M20	MBG543	■		■
85	80	M20	MBG344	■		
85	80	M20	MBG444	■		■
85	80	M25	MBG554	■		■
85	80	M20	MBG345	■		
85	80	M25	MBG455	■		■
85	80	M25	MBG565	■		■
85	80	M25	MBG356	■		
85	80	M25	MBG466	■		■
85	80	M25	MBG368	■		
100	80	M20	MBGAC311	■		■
100	80	M20	MBGAC433	■		■
100	80	M20	MBGAC444	■		■
100	80	M25	MBGAC455	■		■
100	80	M25	MBGAC466	■		■
100	80	M20	MBGAC532	■		■
100	80	M20	MBGAC543	■		■
100	80	M25	MBGAC554	■		■
100	80	M25	MBGAC565	■		■
85	84	M20	MBK311	■		■
85	84	M20	MBK311GB	■		■
80	85	M20	KG411-A	■		Restricted possible
80	85	M20	KG411-C	■		Restricted possible
80	85	M20	KG422-A	■		Restricted possible
80	85	M20	KG422-B	■		Restricted possible
80	85	M20	KG433-A	■		Restricted possible
80	85	M20	KG433-B	■		Restricted possible
80	85	M20	KG432-A	■		Restricted possible
80	85	M20	KG432-B	■		Restricted possible
80	85	M20	KG443-A	■		Restricted possible
80	85	M20	KG443-B	■		Restricted possible
110	88	M20	NBG311	■		Restricted possible
110	88	M20	NBG630		■	
110	88	2x M20	NBG660		■	
110	88	M20	NBG632/NM		■	
110	88	M20	NBG633		■	
110	88	2x M20	NBG664/NM		■	
110	88	2x M20	NBG665		■	
110	88	2x M20	NBG665/65.55		■	
110	88	M20	NBG633/54.50/NSK		■	
110	88	M20	NBG633/54.50		■	
110	88	M20	EBG311.O	■	■	■
110	88	M20	EBG633.O	■	■	■
110	88	M20	EBG665.O	■	■	■
110	88	M20	EX-EBG311.O			■
110	88	M25	EX-EBG633.O			■
110	88	2x M25	EX-EBG665.O			■

# Control panels

## Description

### Area of application

Ergonomic operation of the main machine functions at the human-machine interface is a key factor in safety. The control units should be mounted as close as possible to the safety doors so that operators have an overview of the process. BDF Series control units meet this requirement. This series has been designed for mounting onto the commercially available aluminium profile systems of machine enclosures and you can quickly attach them and integrate them in the ambient structure.

### Design and way of functioning

The range is based on a high-quality design with slimline housing made from impact-resistant plastic. Two designs are available to accommodate one or four command devices or indicator lights.

Users can choose from a large product portfolio of illuminated control push buttons, selector switches and selector buttons, LED illuminated indicators, key-operated switches and standards-compliant EMERGENCY STOP command devices. Positioning of the pushbuttons on the control panel is also freely selectable. Labelling fields allow you to label the functions individually.

This makes it possible for machine builders to use the BDF range to represent the most common operator functions like Emergency Stop, ON/OFF, Forwards/Backwards, Operating Mode Selection, display of operating status conditions or error messages, etc. All the command devices and indicator lights have been developed for industrial applications and have been tried and tested in other series of the command device product portfolio.

The system also includes a mounting plate to combine the control panel with a solenoid interlock and an ergonomic door handle. The BDF 200 AS variant is available to integrate operating devices into the AS Interface Safety at Work (AS-i SaW) communications network.



## Sample application



The photo shows a combination with the BDF200 and an AZM200 solenoid interlock, including a B30 door-handle actuator with the mounting plate as an elegant safety door solution. This positive connection between the BDF200 control panel and the AZM200 solenoid interlock offers machine operators a whole new level of convenience.

# Control panels

## Technical data



■ BDF100...-NH



■ BDF100...

### Key Features

- |   |  |  |
|---|--|--|
| <ul style="list-style-type: none"> <li>• Slim, shock-resistant thermoplastic enclosure</li> <li>• For mounting on commercially available aluminium profile systems</li> </ul> | <ul style="list-style-type: none"> <li>• EMERGENCY STOP function with and without protective collar</li> </ul> | <ul style="list-style-type: none"> <li>• Large product portfolio of operating and lighting elements</li> </ul> |
|---|--|--|



### Other designs

ATEX / IECEx	-	-
AS-i SaW	-	-

### Technical features

General description	Control panel with EMERGENCY STOP	Control panel with one control element
<b>Mechanical data</b>		
Housing material	Glass-fibre reinforced thermoplastic, self-extinguishing	Glass-fibre reinforced thermoplastic, self-extinguishing
Colour (of cover/enclosure box)	Yellow / Black	Black / Black
Dimensions L x W x H (with connector)		
With protective collar	99 x 40 x 69 mm	-
Without protective collar	99 x 40 x 49 mm	99 x 40 x 49 mm
Connection	Connector plug M12, 8-pole	Connector plug M12, 8-pole
<b>Electrical data</b>		
Rated operating voltage U <sub>e</sub>	24 V	24 V
Thermal test current I <sub>the</sub>	2.5 A	2.5 A
Utilisation category	AC-15: 24 VAC/2 A; DC-13: 24 VDC/1 A	AC-15: 24 VAC/2 A; DC-13: 24 VDC/1 A
Switching of low loads	5 V / 1 mA	5 V / 1 mA
Rated insulation voltage U <sub>i</sub>	60 V	60 V
<b>Circuit versions</b>		
EMERGENCY STOP	2 NC / 1 NO	-
Command devices	-	1 NO / 1 NC; 2 NO
EMERGENCY STOP with lamp	2 NC / 1 NO	-
Command devices with lamp	-	1 NO / 1 NC; 2 NO
<b>Ambient conditions</b>		
Ambient temperature	-25 °C ... +65 °C	-25 °C ... +65 °C
Protection class	IP65	IP65

### Safety classification

Standards	EN ISO 13849-1	EN ISO 13849-1
Mechanical life	100,000	1,000,000
B <sub>10d</sub> value	100,000	100,000
Certificates		



■ BDF200-NH-...



■ BDF200...

- EMERGENCY STOP function with and without protective collar
- Large product portfolio of operating and lighting elements

- Large product portfolio of operating and lighting elements

-	-
■	■

Control panel with EMERGENCY STOP and 3 control elements	Control panel with 4 control elements
Glass-fibre reinforced thermoplastic, self-extinguishing Yellow / Black	Glass-fibre reinforced thermoplastic, self-extinguishing Black / Black
220 x 40 x 69 mm	-
220 x 40 x 49 mm	220 x 40 x 49 mm
M20 cable gland with plug-in terminals	M20 cable gland with plug-in terminals
24 V 2.5 A	24 V 2.5 A
AC-15: 24 VAC/2 A; DC-13: 24 VDC/1 A	AC-15: 24 VAC/2 A; DC-13: 24 VDC/1 A
5 V / 1 mA	5 V / 1 mA
60 V	60 V
2 NC / 1 NO	-
1 NC / 1 NO; 2 NO	1 NC / 1 NO; 2 NO
2 NC	-
1 NO	1 NO
-25 °C ... +65 °C	-25 °C ... +65 °C
IP65	IP65





EN ISO 13849-1 1,000,000 (EMERGENCY STOP 100,000)	EN ISO 13849-1 1,000,000
100,000	100,000

# Control panels

## Actuating elements

EMERGENCY STOP pushbutton NH	EMERGENCY STOP pushbutton NHK	Pushbutton DT..
 <ul style="list-style-type: none"> <li>■ Mushroom-shaped plastic button, Ø 30 mm</li> <li>■ Without protective collar: ordering suffix NH</li> <li>■ Pull to reset</li> <li>■ 1 NO contact / 2 NC contacts</li> </ul>	 <ul style="list-style-type: none"> <li>■ Mushroom-shaped plastic button, Ø 30 mm</li> <li>■ With protective collar: ordering suffix NHK</li> <li>■ Pull to reset</li> <li>■ 1 NO contact / 2 NC contacts</li> </ul>	 <ul style="list-style-type: none"> <li>■ With concave button, button surface 19 x 19</li> <li>■ 2 NO contacts or 1 NO contact / 1 NC contact</li> <li>■ Printing is possible on request</li> <li>■ Refer to the table below for the ordering suffix</li> </ul>







Indicator lights LM..	EMERGENCY STOP pushbutton PT..	Illuminated pushbutton LT..
 <ul style="list-style-type: none"> <li>■ Illuminated surface 19 x 19 mm</li> <li>■ Lamp replacement at the front</li> <li>■ Printing is possible on request</li> <li>■ Refer to the table below for the ordering suffix</li> </ul>	 <ul style="list-style-type: none"> <li>■ Button surface 25 x 25 with rounded edges</li> <li>■ Without latching</li> <li>■ 2 NO contacts or 1 NO contact / 1 NC contact</li> <li>■ Printing is possible on request</li> <li>■ Refer to the table below for the ordering suffix</li> </ul>	 <ul style="list-style-type: none"> <li>■ With concave button, button surface 19 x 19</li> <li>■ 2 NO contacts or 1 NO contact / 1 NC contact</li> <li>■ Lamp replacement at the front</li> <li>■ Printing is possible on request</li> <li>■ Refer to the table below for the ordering suffix</li> </ul>

Ordering suffix	yellow	red	green	blue	Black	white
 EMERGENCY STOP pushbutton PT..	PTYE	PTRD	PTGN	PTBU	PTBK	PTWH
 Pushbutton DT..	DTYE	DTRD	DTGN	DTBU	DTBK	DTWH
 Illuminated pushbutton LT..	LYE	LTRD	LTGN	LTBU		LTWH
 Indicator lights LM..	LYE	LTRD	LTGN	LTBU		LTWH

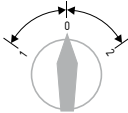
# Control panels

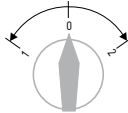
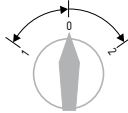
## Actuating elements









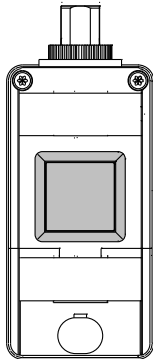

Maintained / spring-return selector switches	Maintained / spring-return selector switches	Key-operated selector switches/buttons
 <ul style="list-style-type: none"> <li>Version with standard toggle, anthracite</li> <li>Refer to the table below for the ordering suffix</li> </ul>	 <ul style="list-style-type: none"> <li>Version with long toggle, anthracite</li> <li>Refer to the table below for the ordering suffix</li> </ul>	 <ul style="list-style-type: none"> <li>Version with high-quality cylinder lock; therefore, IP65 in this case too</li> <li>Key can be removed in all positions</li> <li>Refer to the table below for the ordering suffix</li> </ul>

Ordering suffix	Selector switch	Selector switch	Selector switch	Selector switch	Selector switches
					
	1 latched position	2 latched positions to the left/right of the zero position	1 momentary position and automatic return to the zero position	2 touch positions to the left/right of the zero position and automatic return to the zero position	1 momentary position on the right and automatic return to the zero position and 1 maintained position to the left of the zero position
	2 NO or 1 NO / 1 NC	1 NO per position or 1 NC (position 1) / 1 NO (position 2)	2 NO or 1 NO / 1 NC	1 NO per position or 1 NC (position 1) / 1 NO (position 2)	1 NO per position or 1 NC (position 1) / 1 NO (position 2)
 Standard toggle	<b>WS20</b>	<b>WS30</b>	<b>WT20</b>	<b>WT30</b>	<b>WTS30</b>
 Long toggle	<b>WS21</b>	<b>WS31</b>	<b>WT21</b>	<b>WT31</b>	<b>WTS31</b>
 Key-operated switch	<b>SWS20</b>		<b>SWT20</b>		

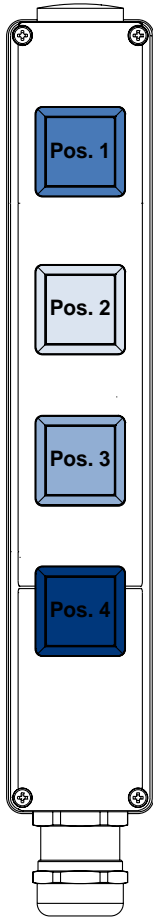
For detailed information on selection, visit [www.schmersal.net](http://www.schmersal.net)

# Control panels



## Combination options

Actuating elements		BDF100 with	BDF200				Control panels
			at pos. 1	at pos. 2	at pos. 3	at pos. 4	
	NH	•	•				<b>BDF100</b> 
	NHK	•	•				
	PT..		•	•	•	•	
	DT..	•	•	•	•	•	<b>BDF200</b> 
	LT..	•	•	•	•	•	
	LM..		•	•	•	•	
	SW.20	•		•	•		
	W..0	•		•	•		
	W..1	•		•	•		



## Control panels

### Preferred types<sup>1)</sup> and accessories

Series	Fitting at pos. 1	Pos. 2	Pos. 3	Pos. 4	Indicator lamp	Type designation	Material number
<b>BDF100</b> 	NH	-	-	-	-	BDF100-NH-G-ST	101215862
	NHK	-	-	-		BDF100-NHK-G-ST	101211974
	LTBU	-	-	-		BDF100-11-LTBU-ST	101216402
	LTGN	-	-	-		BDF100-11-LTGN-ST	101216247
	SWS20	-	-	-	green	BDF100-11-SWS20-ST	101217193
	WS20	-	-	-		BDF100-11-WS20-G/GN-ST	103001068
	LTBU	-	-	-		BDF100-20-LTBU-ST	101217770
	LTGN	-	-	-		BDF100-20-LTGN-ST	101217217
<b>BDF200</b> 	NH	LTGN	LTGN	LYE	red	BDF200-NH-10-LTGN-LTGN-LMYE-G24	103000487
		LYE	SWS20	LTBU		BDF200-NH-10-LTYE-SWS20-LTBU-G24	103000657
		LTBU	LTRD	LTGN	-	BDF200-NHK-20-LTGN-LTBU-LTRD	101212033
		SWS20	LTGN	LTRD		BDF200-NHK-20-LTGN-LTBU-LTRD	101212023
		LT	LT	LT		BDF200-NH-10-LT-LT-LT-2875	103007781
		LT	LT	LT		BDF200-NH-11-LT-LT-LT-2875	103007782
		LT	LT	LT		BDF200-NH-20-LT-LT-LT-2875	103007783
		SWS20	LT	LT		BDF200-NH-11-SWS20-LT-LT-2875	103007789
	SWS20	LT	LT	BDF200-NH-20-SWS20-LT-LT-2875		103007790	
	WT30	DTRD	DTGN	BDF200-NHK-11-WT30-DTRD-DTGN		101212034	
	NHK	LTGN	LTBU	LTRD	-	BDF200-NHK-20-LTGN-LTBU-LTRD	101211180
		LT	LT	LT		BDF200-NKH-10-LT-LT-LT-2875	103007784
		LT	LT	LT		BDF200-NHK-11-LT-LT-LT-2875	103007785
		LT	LT	LT		BDF200-NHK-20-LT-LT-LT-2875	103007786
		SWS20	LT	LT		BDF200-NHK-11-SWS20-LT-LT-2875	103007791
		SWS20	LT	LT		BDF200-NHK-20-SWS20-LT-LT-2875	103007792
	LT	LT	LT	LT	-	BDF200-LT-11-LT-LT-LT-2875	103007787
		LT	LT	LT		BDF200-LT-20-LT-LT-LT-2875	103007788

AZM 200	MP BDF 200	101214126
 <ul style="list-style-type: none"> <li>Can be combined with the AZM200 solenoid interlock</li> <li>For more information, visit <a href="http://www.schmersal.net">www.schmersal.net</a></li> </ul>	 <ul style="list-style-type: none"> <li>Mounting plate for combination of AZM200 solenoid interlock with -B30 actuator and BDF200 control panel</li> </ul>	

<sup>1)</sup> The preferred types designate the choice of devices with faster delivery times.

Type designation **-2875**: the coloured button caps are included in the scope of delivery as an accessory pack for customers to mount themselves.

To see a wide range of other types, visit [www.schmersal.net](http://www.schmersal.net)

# Two-hand control panels

## Description

### Area of application

The job of two-hand controls or two-hand control panels is to ensure that machine operators hands are located on the control panel when they issue the control signal for a hazardous movement. This prevents operators from reaching into the danger area on starting or shortly after starting the machine or process.

The main areas of application for two-hand controls are presses and stamping units in the metal processing or powder metallurgy industries as well as similar machines and systems that involve manual insertion and removal operations. These include printing and paper processing machines, rubber and plastics processing machines, machines involved in the chemical industry and assembly plants.

### Design and way of functioning

Two-hand control panels are designed as such so the operators need both hands at the same time to start a hazardous movement. This forces operators to keep their hands in the same place which means that they cannot reach into the danger zone while the system is carrying out the hazardous movement.

All Schmersal Group two-hand control panels are fitted with an Emergency Stop button that complies with EN ISO 13850. Apart from this, there are guard hoods over the operating elements, which prevent people from circumventing the protection function using their hands, elbows, stomach, hips, thighs or knees, for example. It is also not possible to operate from the back of the control panels.



The devices comply with the requirements of EN 574, which, amongst other things, specifies the spacing of the controls. Users can choose between different versions that differ, amongst other things, by virtue of the material of the enclosure (plastic and die-cast aluminium). In the central part of the folding enclosure, it is possible to mount up to eight additional command and signalling devices.

Accessories include, amongst other things, various stand versions. Combined with the PROTECT SRB 201 ZH safety-monitoring module, it is possible to integrate two-hand control panels into the machine controller.

## Wide selection of mounting posts

You can find appropriate mounting posts and other accessories on page 88 and in our online catalogue at [www.schmersal.net](http://www.schmersal.net).



# Two-hand control panels

## Technical data



SEP-K02

SEP-G05

### Key Features

- Enclosure, plastic
- Control panel with 8 additional drilled holes that you can knock out if required
- 2-piece enclosure for simple and favourable assembly

- Die-cast aluminium enclosure
- Control panel suitable for mounting a minimum of 8 additional command and signalling devices
- Easy assembly thanks to 2-piece folding enclosure
- Ergonomic operation due to wrist support
- Terminal strips and relay assembly possible in the interior

### Technical features

General description	Two-hand control panel	Two-hand control panel
<b>Mechanical data</b>		
<b>Housing material</b>	Thermoplastic	Die-cast aluminium
<b>Colour</b>	RAL 7035 (tinted)	RAL 7004 (powder-coated)
<b>Dimensions (L x W x H)</b>	469 x 137 x 185 mm	494 x 160 x 184 mm
<b>Possible fastening</b>		
<b>On mounting post</b>	Yes	Yes
<b>Directly on the machine or wall</b>	Yes	Yes
<b>Command positions</b>		
<b>Number of drilled holes</b>	3	3
<b>Possible command positions</b>	8	8
Ø of drilled hole	22.3 mm	22.3 mm
<b>Electrical data</b>	Depends on the pre-mounted command device	Depends on the pre-mounted command device
<b>Ambient conditions</b>		
<b>IP Protection class</b>	IP54	IP54

### Safety classification

<b>Standards</b>	IEC 60947-5-1; IEC 60947-1; IEC 60947-5-5; EN ISO 13850; EN 574	IEC 60947-5-1; IEC 60947-1; IEC 60947-5-5; EN ISO 13850; EN 574
<b>Certificates</b>	-	-

We recommend using our SRB safety-monitoring module to monitor two-hand control panels.

You can also find appropriate mounting posts, command devices and other accessories in our online catalogue at [www.schmersal.net](http://www.schmersal.net).



## SEP09

- Aluminium enclosure
- For separate assembly of the controls for two-hand control
- Specify on user side spacing according to EN 574

Two-hand control

Aluminium

RAL 7004 (powder-coated)

155 x 150 x 160 mm  
(per operating element)

No

Yes

1 per operating element

-

22.3 mm

Depends on the  
pre-mounted command device

IP54

IEC 60947-5-1; IEC 60947-1;  
IEC 60947-5-5;  
EN ISO 13850; EN 574

-



## Two-hand control panels

### Preferred types <sup>1)</sup>

Series	Enclosure	Description	Controls	Head Ø	Contacts	
SEPK02	Thermoplastic	2-piece enclosure with 8 additional drilled holes that you can knock out if required	ADP55.3SW		55 mm	1 NO / 1 NC
			ADP55.3SW/O.F			
			Empty enclosure			
SEPG05	Metal	2-part enclosure suitable for mounting a minimum of 8 additional command and signalling devices	EDP42SW		42 mm	1 NO / 1 NC
			EDP55SW		55 mm	1 NO / 1 NC
			ADP55.3SW		55 mm	1 NO / 1 NC
			Empty enclosure			
SEPO9	Metal	For separate assembly of the controls for two-hand control with detachable aluminium cover on the bottom	EDP55SW		55 mm	1 NO / 1 NC
			EDP42SW		42 mm	1 NO / 1 NC
			Empty enclosure			

<sup>1)</sup> The preferred types designate the choice of devices with faster delivery times.

For the technical data of the command devices, visit [www.schmersal.net](http://www.schmersal.net).

EMERGENCY STOP		Head Ø	Contacts	Type designation	Material number
ADRR40RT		40 mm	1 NO / 1 NC	SEPK02.0.4.0.22/95	101027371
				SEPK02.0.4.0.22/95.E2	101211126
				SEPK02.0.L.22	101027369
EDRR40RT		40 mm	1 NO / 1 NC	SEPG05.3.3.0.22/95	101172764
EDRR50RT		50 mm	1 NO / 1 NC	SEPG05.3.2.0.22/95	101172762
EDRR40RT		40 mm	1 NO / 1 NC	SEPG05.3.4.0.22/95	101172765
EDRR50RT		50 mm	1 NO / 1 NC	SEPG05.3.1.0.22/95	101172760
EDRR40RT		40 mm	1 NO / 1 NC	SEPG05.3.4.0.22/95.E1	101210845
				SEPG05.3.L.22	101172767
-		-	-	SEP09.0.1.0.22/95	101022849
-		-	-	SEP09.0.3.0.22/95	101022851
				SEP09.0.L.22	101022856

# Two-hand control panels

## Mounting post

<b>STPLC1</b>	<b>101024774</b>	<b>STP 01.1.1</b>	<b>101022859</b>	<b>STP 01.4.1</b>	<b>101022861</b>
 <ul style="list-style-type: none"> <li>■ Welded structure with base-fastening tapped holes</li> <li>■ Without height adjustment, without distance ring</li> <li>■ Can be combined with SEP ... control panel for use as a two-hand foot operating station</li> </ul>		 <ul style="list-style-type: none"> <li>■ Welded structure with base-fastening tapped holes</li> <li>■ Without height adjustment</li> <li>■ Without distance ring</li> </ul>		 <ul style="list-style-type: none"> <li>■ Welded structure with base-fastening tapped holes</li> <li>■ Without height adjustment</li> <li>■ With distance ring</li> </ul>	
<b>STP 01.5.1</b>	<b>101022863</b>	<b>STP 02.1.1</b>	<b>101022865</b>	<b>STP 02.4.1</b>	<b>101022867</b>
 <ul style="list-style-type: none"> <li>■ Welded structure with base-fastening tapped holes</li> <li>■ Without height adjustment, with distance ring</li> <li>■ Fixing of the distance ring by fixing and welding on the user side</li> </ul>		 <ul style="list-style-type: none"> <li>■ Welded structure with base-fastening tapped holes</li> <li>■ With height adjustment</li> <li>■ Without distance ring</li> </ul>		 <ul style="list-style-type: none"> <li>■ Welded structure with base-fastening tapped holes</li> <li>■ With height adjustment</li> <li>■ With distance ring</li> </ul>	
<b>STPSK1</b>	<b>101171474</b>				
 <ul style="list-style-type: none"> <li>■ Mobile sheet-metal structure with base-fastening tapped holes</li> <li>■ With height adjustment</li> <li>■ With distance ring</li> <li>■ Can be combined with SEP ... control panel and foot switches with protective hood for use as a two-hand foot operating station</li> </ul>					

For detailed information on selection, visit [www.schmersal.net](http://www.schmersal.net)



## Two-hand control panels

### Recommended evaluations

SRB 201ZH-24VDC



- Evaluation of two-hand operator inputs
- 2 STOP 0 safety contacts
- 1 auxiliary contact (not safe)
- For more information, visit [www.schmersal.net](http://www.schmersal.net)

SRB 301HC/R-24V/-230V



- Evaluation of two-hand operator inputs
- 3 STOP 0 safety contacts
- 1 auxiliary contact
- For more information, visit [www.schmersal.net](http://www.schmersal.net)

# Maintained and spring-return joystick switches

## Description

### Area of application

Extremely robust, compact, versatile and functional: These properties make MK/WK series joystick buttons and switches highly suitable for use on machinery and plants in the food-processing and process technology industries.

Furthermore, they are suitable for especially harsh industrial applications, including outdoor usage. Compared with multifunctional command systems, such as those used on the control units for cranes and automated guided vehicles (AGV), they need considerably less installation space.

### Design and way of functioning

Users can choose between three designs:

- Maintained joystick switch, reset by touch and spring force
- Spring-return joystick switch, reset by spring force
- Maintained and spring-return joystick switch, reset by touch and spring force

All the designs are available with up to four switch positions/actuating directions.

This means that the joystick switches and buttons make the HMI easier: It is possible to actuate different machine functions with a single, compact piece of robust switchgear.

The joystick switches and buttons are available in a wide range of different contact variants with up to eight galvanically isolated contacts as well as in protection classes IP65, IP67 and IP69K. We can also supply versions for outdoor applications that are suitable for temperatures of -25 °C to +80 °C. If you want protection from accidental actuation from the zero position, it is possible to fit the operating devices with a mechanical lock.

The contact system in series MK and WK works on the tried and tested four-way contact ("H bridge") principle that is extremely shock- and jolt-resistant.



## Operating principle

### Spring-return joystick switch

Spring-return switching position (touch position)  
Reset by spring force

### Maintained joystick switch

Maintained switching positions (latched position)  
Reset by touch and spring force

### Maintained/spring-return joystick switch

Switching position spring-return and maintained  
Reset by touch and spring force



### Locking sleeve

All devices are available with an additional mechanical lock as a protection against accidental shifts out of the home position. The holding force of the lock is approx. 100 N for devices with an installation diameter of 22.3 mm and approx. 200 N for devices with an installation diameter of 30.5 mm.



# Maintained and spring-return joystick switches

## Technical data



■ MKT



■ MKS

### Key Features

- Mounting hole Ø 22.3 mm
- Spring-return joystick switch

- Mounting hole Ø 22.3 mm
- Maintained joystick switch

### Technical features

<b>Mechanical data</b>		
Length of actuator	77 mm	77 mm
Material of the front ring	Al anodised	Al anodised
Fixing	Lock nut	Lock nut
Mounting hole	22.3 mm	22.3 mm
Installation depth	Depending on contact type	Depending on contact type
Front plate thickness	1.5 mm ... 6 mm	1.5 mm ... 6 mm
Spacing	80 × 80 mm	80 × 80 mm
Actuating force	approx. 11 N	approx. 11 N
Momentary position	To left and right of zero position	-
Latched position	-	To left and right of zero position
Resistance to shock	110 g/4 ms – 30 g/18 ms, no bouncing	110 g/4 ms – 30 g/18 ms, no bouncing
Resistance to vibrations	> 20 g/10 ... 200 Hz	> 20 g/10 ... 200 Hz
Switching frequency	1,200 s/h	1,200 s/h
Switching principle	Creep circuit element	Creep circuit element
Design of elect. connection	Screw terminals	Screw terminals
Cable section	0.5 mm <sup>2</sup> ... 2.5 mm <sup>2</sup>	0.5 mm <sup>2</sup> ... 2.5 mm <sup>2</sup>
<b>Electrical data</b>		
Rated impulse withstand voltage $U_{imp}$	4 kV	4 kV
Rated insulation voltage $U_i$	400 V	400 V
Thermal test current $I_{the}$	10 A	10 A
Max. fuse rating	10 A gG D-fuse	10 A gG D-fuse
Utilisation category	AC-15: 250 VAC/8 A; DC-13: 24 VDC/5 A	AC-15: 250 VAC/8 A; DC-13: 24 VDC/5 A
<b>Ambient conditions</b>		
Ambient temperature	-25 °C ... +80 °C	-25 °C ... +80 °C
Protection class	IP65 / IP67 to IEC 60529	IP65 / IP67 to IEC 60529

### Safety classification

Standards	IEC 60947-5-1, IEC 60947-1	IEC 60947-5-1, IEC 60947-1
Mechanical life	1,000,000	1,000,000
$B_{10d}$ value	100,000	100,000



■ WKT



■ WKS

- Mounting hole Ø 30.5 mm
- Spring-return joystick switch

- Mounting hole Ø 30.5 mm
- Maintained joystick switch

90 mm	90 mm
Al anodised	Al anodised
mounting flange	mounting flange
30.5 mm	30.5 mm
Depending on contact type	Depending on contact type
1.5 mm ... 10 mm	1.5 mm ... 10 mm
80 x 80 mm	80 x 80 mm
approx. 11 N	approx. 11 N
To left and right of zero position	-
-	To left and right of zero position
110 g/4 ms – 30 g/18 ms, no bouncing	110 g/4 ms – 30 g/18 ms, no bouncing
> 20 g/10 ... 200 Hz	> 20 g/10 ... 200 Hz
1,200 s/h	1,200 s/h
Creep circuit element	Creep circuit element
Screw terminals	Screw terminals
0.5 mm <sup>2</sup> ... 2.5 mm <sup>2</sup>	0.5 mm <sup>2</sup> ... 2.5 mm <sup>2</sup>
4 kV	4 kV
400 V	400 V
10 A	10 A
10 A gG D-fuse	10 A gG D-fuse
AC-15: 250 VAC/8 A; DC-13: 24 VDC/5 A	AC-15: 250 VAC/8 A; DC-13: 24 VDC/5 A
-25 °C ... +80 °C	-25 °C ... +80 °C
IP65 / IP67 to IEC 60529	IP65 / IP67 to IEC 60529
IEC 60947-5-1, IEC 60947-1	IEC 60947-5-1, IEC 60947-1
1,000,000	1,000,000
100,000	100,000

# Maintained and spring-return joystick switches

## Selection aid

### 1<sup>st</sup> step: Selection of the device design

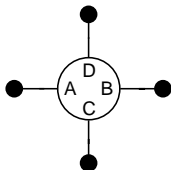
Choice of device	Contact variants				Spring-return joystick switch			
	Position	Position	Position	Position	Range MKT Mounting - Ø 22.3 mm		Range WKT Mounting - Ø 30.5 mm	
	A	B	C	D	without locking sleeve	with locking sleeve	without locking sleeve	with locking sleeve
	1 NO	1 NO			MKTA32	MKTA321	WKTA32	WKTA321
	1 NC	1 NC			MKTA32/401	MKTA321/401	WKTA32/401	WKTA321/401
	2 NO	2 NO			MKTB32	MKTB321	WKTB32	WKTB321
	1 NC/1 NO	1 NC/1 NO			MKTB32/1x401	MKTB321/1x401	WKTB32/1x401	WKTB321/1x401
	2 NO	2 NO			MKTC32	MKTC321	WKTC32	WKTC321
	1 NO	1 NO	1 NO		MKTC42	MKTC421	WKTC42	WKTC421
	1 NO	1 NO	1 NO	1 NO	MKTC52	MKTC521	WKTC52	WKTC521
	1 NC	1 NC	1 NC	1 NC	MKTC52/2x401	MKTC521/2x401	WKTC52/2x401	WKTC521/2x401
	4 NO	4 NO			MKTE32	MKTE321	WKTE32	WKTE321
	4 NC	4 NO			MKTE32/404	MKTE321/404	WKTE32/404	WKTE321/404
	4 NC	4 NC			MKTE32/800	MKTE321/800	WKTE32/800	WKTE321/800
	2 NO	2 NO	2 NO	2 NO	MKTE52	MKTE521	WKTE52	WKTE521
	1 NC/ 1 NO	1 NC/ 1 NO	2 NO	2 NO	MKTE52/206	MKTE521/206	WKTE52/206	WKTE521/206
	2 NC	2 NO	2 NO	2 NO	MKTE52/206.1	MKTE521/206.1	WKTE52/206.1	WKTE521/206.1
	1 NC/1 NO	1 NC/1 NO	1 NC/1 NO	1 NC/1 NO	MKTE52/2x401	MKTE521/2x401	WKTE52/2x401	WKTE521/2x401

### 2<sup>nd</sup> step: Selection of the bellows

Bellows	Standard	/WKT-19.4	/WKT-19.3	/WKT-26
<b>Description</b>	Bellows rubber	Bellows rubber, suitable for outdoor usage	Silicone bellows, UV-resistant up to -40 °C	Silicone bellows, UV-resistant, up to -40 °C thick-walled / tear-proof IP69K
<b>Material thickness</b>	approx. 1 mm		approx. 2 mm	
<b>Material features</b>	tear-proof		partly tear-proof	tear-proof
<b>Protection class (frontside)</b>	IP65 / IP67		IP67 / IP69K	
<b>Ambient temperature</b>	-25 ... +80 °C		-40 ... +80 °C	
<b>Mechanical life</b>	1,000,000	500,000	300,000	500,000
<b>Notes</b>	-	-	-	Only usable in combination with spring-return joystick switches without locking sleeve
<b>Material resistance</b>	Rubber		Silicone	
- UV/ozone	not suitable	suitable	particularly suitable	
- Outdoor usage	not suitable	suitable	particularly suitable	
- Fuel, oil	partly suitable		not suitable	
- Solvents	partly suitable		partly suitable	
- Acids	partly suitable		not suitable	
- Chemicals	not suitable		partly suitable	
- Foodstuff	not suitable		physiologically harmless	

#### Optional bellows

To order, the order code of the bellows is added to the order code of the switch.

Maintained joystick switch				Maintained/spring-return	
Range MKS Mounting - Ø 22.3 mm		Range WKS Mounting - Ø 30.5 mm		Range WKTS Mounting - Ø 30.5 mm	
without locking sleeve	with locking sleeve	without locking sleeve	with locking sleeve	without locking sleeve	with locking sleeve
MKSA32	MKSA321	WKSA32	WKSA321	WKTSA32 <sup>1)</sup>	WKTSA321 <sup>1)</sup>
MKSA32/401	MKSA321/401	WKSA32/401	WKSA321/401		
MKSB32	MKSB321	WKS32	WKS321		
MKSB32/1x401	MKSB321/1x401	WKS32/1x401	WKS321/1x401		
MKSC32	MKSC321	WKSC32	WKSC321		
MKSC42	MKSC421	WKSC42	WKSC421		
MKSC52	MKSC521	WKSC52	WKSC521	WKTSC52 <sup>2)</sup>	WKTSC521 <sup>2)</sup>
MKSC52/2x401	MKSC521/2x401	WKSC52/2x401	WKSC521/2x401		
MKSE32	MKSE321	WKSE32	WKSE321		
MKSE32/404	MKSE321/404	WKSE32/404	WKSE321/404		
MKSE32/800	MKSE321/800	WKSE32/800	WKSE321/800		
MKSE52	MKSE521	WKSE52	WKSE521		
MKSE52/206	MKSE521/206	WKSE52/206	WKSE521/206		
MKSE52/206.1	MKSE521/206.1	WKSE52/206.1	WKSE521/206.1		
MKSE52/2x401	MKSE521/2x401	WKSE52/2x401	WKSE521/2x401		

<sup>1)</sup> Position A spring-return (touch position) and Position B maintained (latched position)  
<sup>2)</sup> Position C/D spring-return (touch position) and Position A/B maintained (latched position)

### 3<sup>rd</sup> step: Your product

Type designation	
Ordering example	
Mounting hole 22,3 mm	M
Spring-return joystick switch	KT
Contacts 4 NO contacts Position A 4 NO contacts Position B	E32
With locking sleeve	1
Bellows suitable for outdoor usage	/WKT-19.4
	<b>MKTE321/WKT-19.4</b>

# Maintained and spring-return joystick switches

Preferred types <sup>1)</sup>

Moun-ting-Ø	Type	With locking sleeve	Installation depth	Contact variants				Type designation	Material number
				Position A	Position B	Position C	Position D		
22.3 mm	Maintained joystick switch	-	70 mm	1 NO	1 NO	-	-	MKSA32	101005813
		■						MKSA321	101005816
		-	104 mm	2 NO	2 NO	-	-	MKSB32	101203907
		■						MKSB321/WKT-19.3	101191939
		-	70 mm	1 NO	1 NO	1 NO	1 NO	MKSC32	101005817
		■						MKSC321	101005818
		-						MKSC52	101005821
		■	MKSC521	101005822					
		-	112 mm	2 NO	2 NO	2 NO	2 NO	MKSE52/WKT-19.4	101190916
	■	MKSE521						101005826	
	Spring-return joystick switch	-	70 mm	1 NO	1 NO	-	-	MKTA32	101005827
		■						MKTA321	101005829
		-	104 mm	2 NO	2 NO	-	-	MKTB32	101005828
		■						MKTB321	101194681
		-	70 mm	1 NO	1 NO	1 NO	1 NO	MKTC32	101005832
		■						MKTC321	101005835
		-						MKTC52	101005837
		■	MKTC521	101005844					
-		112 mm	4 NO	4 NO	-	-	MKTE321	101190067	
■							MKTE52	101005842	
-			2 NO	2 NO	2 NO	2 NO	MKTE521	101005845	
30.5 mm		Maintained joystick switch	-	57 mm	1 NO	1 NO	-	-	WKSA32
	■		WKSA321						101019545
	-		WKSC32						101019465
	■		WKSC321	101019493					
	-		91 mm	2 NO	2 NO	2 NO	2 NO	WKSC52	101019467
	■							WKSC521	101019473
	-	WKSE52						101019489	
	■	WKSE521	101019492						
	Spring-return joystick switch	-	57 mm	1 NO	1 NO	-	-	WKTA32	101007593
		■						WKTA321	101019509
		-	91 mm	2 NO	2 NO	-	-	WKTB32	101019514
		■						WKTB321	101019539
		-						WKTC32	101007594
		■	WKTC321	101007595					
		-	57 mm	1 NO	1 NO	1 NO	1 NO	WKTC52	101007597
		■						WKTC521	101019447
		-						WKTE52	101019461
		■	WKTE521	101019464					

Schematic representation of positions A-D

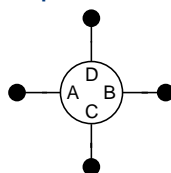

<sup>1)</sup> The preferred types designate the choice of devices with faster delivery times. To see a wide range of other types, visit [www.schmersal.net](http://www.schmersal.net)



# Maintained and spring-return joystick switches

## Dimensions

Range MK... Mounting-Ø 22.3 mm		2 contacts	4 contacts	4 contacts	8 contacts
Without locking sleeve		MKTA32...	MKTB32...	MKTC32...	MKTE32...
		MKSA32...	MKSB32...	MKSC32...	MKSE32...
				MKTC42...	MKTE52...
				MKSC42...	MKSE52...
				MKTC52...	
		MKSC52...			
With locking sleeve		MKTA321...	MKTB321...	MKTC321...	MKTE321...
		MKSA321...	MKSB321...	MKSC321...	MKSE321...
				MKTC421...	MKTE521...
				MKSC421...	MKSE521...
				MKTC521...	
		MKSC521...			

MP = Mounting plate (Series MK... Max. thickness 6 mm)

Range WK... Mounting-Ø 30.5 mm		2 contacts	4 contacts	4 contacts	8 contacts
Without locking sleeve		WKTA32...	WKTB32...	WKTC32...	WKTE32...
		WKSA32...	WKS32...	WKSC32...	WKSE32...
		WKTA32...		WKTC42...	WKTE52...
				WKSC42...	WKSE52...
				WKTC52...	
		WKSC52...			
		WKTC52...			
With locking sleeve		WKTA321...	WKTB321...	WKTC321...	WKTE321...
		WKSA321...	WKS321...	WKSC321...	WKSE321...
		WKTA321...		WKTC421...	WKTE521...
				WKSC421...	WKSE521...
				WKTC521...	
		WKSC521...			
		WKTC521...			
		WKSC521...			

MP = Mounting plate (Series WK... Max. thickness 10 mm)

# Enabling switches

## Description

### Area of application

When carrying out set-up, refitting or service work on plant or machinery, it can be beneficial to partially or completely deactivate guard systems. Typically, this includes setting up a machine (set-up mode) and monitoring machining procedures (process monitoring).

One example: The operator of a machine tool is able to check format settings better and program movements more exactly if the safety door is open. The better view of the process makes operation more convenient and reduces set-up and refitting times.

Special safety measures are needed for this case and similar ones; these measures are referred to as special operating modes and are specified in the machine directive and in some type C standards.

The measures that are required in this case include enabling devices that operators must actuate to start up the respective machine functions. In many cases, this is a slowed-down machine movement. The effect of the guard system is only partially or entirely suspended for the time in which the operator presses the enabling device.

---

### Design and way of functioning

Operators must put the enabling device into the centre position and hold it in this position. As soon as they release the button or press it all the way down, the system interrupts the control command on a safety-related basis.

Series ZSD5 and ZSD6 enabling devices are of ergonomic design; with Series ZSD6, an additional pushbutton is integrated in the device head. Operators can select the optimum position to the machine or the process; the connection to the machine controller is guaranteed by a signal line.

Both series are suitable for robot applications in accordance with ANSI standards. There are of course suitable safety-monitoring modules available for signal evaluation.

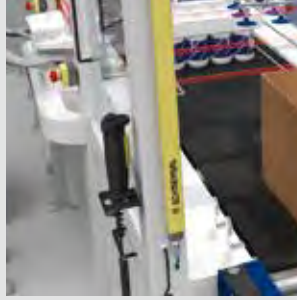

## Permissible speeds in enabling mode

It is controversial and standards deal differently with the question of what "reduced" speeds are justifiable in enabling mode to comply with the further condition of the machine directive (see Machine Directive Appendix I, Clause 1.2.5) that the operation of dangerous functions is only possible under minor risk conditions (= reduced speed, reduced power, step mode, etc.)

A man who has a C standard that offers concrete information that can be used for his individual application is a happy man.

Otherwise, it is advisable to differentiate between crushing and shearing hazards on the one hand and "just" collision hazards on the other. In this connection, people frequently quote values of 33 mm/sec. (2 m/min.) max. in the case of crushing and shearing hazards and 250 mm/sec. (15 m/min.) max. in the case of collision hazards A. MRL 2006/42/EG, however, "permits" higher values if absolutely technically necessary and execution is integrated into a considered and coherent safety concept [b/c].

That just leaves the question of whether it is possible to control the reduced speed (power, movement etc.) via the operating controller or whether you need a safety-related controller or monitoring system, e.g. Safety Limited Speed (SLS) or similar in accordance with EN/IEC 61800-5-2.

In this case too, we refer you to the "responsible" standards (to some extent, it is adequate to use just enabling devices for minor risks with a safe controller or monitoring system only being required above and beyond this, to some extent there is, however, a general requirement for "enabling devices + SLS", for example).

You must equally consider that the state of the art is tending towards "SLS for example" (i.e. "safe controllers or monitoring systems"), since more and more drives and drive controllers with integrated safety functions are on the market. However, it is not possible to use these new options in every situation whether due to compelling technical reasons and/or for reasons of cost.

It can help to consider whether pressing the enabling device through from stage 2 to stage 3, taking into account the machine's reaction time (delay time after signalling to standstill or non-critical speed) PLUS an additional human response time of 1 second, for example, results in an operating status that is acceptable to the machine operator from a safety point of view or not.

---

A You can find an overview of the maximum speeds that there are for manual intervention on running machines in the IFA Manual (loose leaf collection - Lfg. 2/11 - XII/2011 - Clause 330 216).

B See Machine Directive Appendix I, Clause 1.2.5: If it is not possible to comply with these requirements at the same time, the (mode selector switch) must trigger other protective measures ..., such that a safe working area is guaranteed.

C See also specialist committee information sheet 002 of specialist committee MFS of DGUV Wood and Metal Professional Association, Mainz, Process Monitoring on the Shopfloor.

# Enabling switches

## Technical data



■ ZSD 5

■ ZSD 6

### Key Features



- 3-stage grip switch OFF-ON-OFF
- Contacts do not close on resetting from stage 3 → stage 1

- 3-stage grip switch OFF-ON-OFF
- Contacts do not close on resetting from stage 3 → stage 1
- With additional pushbutton

### Technical features

<b>Mechanical data</b>		
Housing material	Plastic, thermoplastic, self-extinguishing	Plastic, thermoplastic, self-extinguishing
Additional pushbutton in device head	No	YES
Number of NO contacts	2	3
With positive break (stages 2-3)	2	2
Number of NC contacts	1	1
Switching frequency	max. 1200/h	max. 1200/h
Cable section	0.14 mm <sup>2</sup> ... 1.5 mm <sup>2</sup>	0.14 mm <sup>2</sup> ... 1.5 mm <sup>2</sup>
Connection	Screw terminals	Screw terminals
<b>Electrical data</b>		
Rated operating voltage U <sub>e</sub>	250 V	250 V
Operating current I <sub>e</sub>	3 A	3 A
Utilisation category NO contacts	AC-15: 125 V / 1.5 A; 250 V / 0.75 A; DC-13: 30 V / 1.0 A; 125 V / 0.22 A; 250 V / 0.1 A	AC-15: 125 V / 1.5 A; 250 V / 0.75 A; DC-13: 30 V / 1.0 A; 125 V / 0.22 A; 250 V / 0.1 A
Auxiliary contacts	AC-15: 125 V / 1.5 A; 250 V / 0.75 A; DC-13: 30 V / 2.3 A; 125 V / 0.22 A; 250 V / 0.1 A	AC-15: 125 V / 1.5 A; 250 V / 0.75 A; DC-13: 30 V / 2.3 A; 125 V / 0.22 A; 250 V / 0.1 A
Additional pushbutton	-	AC-15: 125 V / 0.3 A; DC-13: 30 V / 0.7 A; 125 V / 0.1 A
<b>Ambient conditions</b>		
Ambient temperature	-10 °C ... +60 °C	-10 °C ... +60 °C
Protection class IP	IP65	IP65

### Safety classification

Standards	ISO 13849-1, IEC 61508	ISO 13849-1, IEC 61508
Mechanical life	Stage 1-2-1: min. 1,000,000; Stage 1-2-3-1: min. 100,000	Stage 1-2-1: min. 1,000,000; Stage 1-2-3-1: min. 100,000
B <sub>10d</sub> value	100,000	100,000
Certificates		

## Enabling switches

### Ordering details and recommended evaluations

Type	Description	Connecting cable	Type designation	Material number
Enabling switches	3-stage grip switch	Without	ZSD5/O.LTG	101199467
		5 m	ZSD5/5M	101199469
		10 m	ZSD5/10M	101199471
	3-stage grip switch with additional pushbutton in device head	Without	ZSD6/O.LTG	101199480
		5 m	ZSD6/5M	101210087
		10 m	ZSD6/10M	101199483
Accessories	Mounting angle made of metal		ZSD-H	101163725

## Recommended evaluations

PROTECT SELECT	SRB 301ST	SRB 301MC
		
<ul style="list-style-type: none"> <li>■ Evaluation of enabling devices</li> <li>■ STOP 0 or STOP 1, depending on the setting values in the application program</li> <li>■ For more information, visit <a href="http://www.schmersal.net">www.schmersal.net</a></li> </ul>	<ul style="list-style-type: none"> <li>■ Evaluation of enabling devices</li> <li>■ 1- or 2-channel control, STOP 0</li> <li>■ For more information, visit <a href="http://www.schmersal.net">www.schmersal.net</a></li> </ul>	<ul style="list-style-type: none"> <li>■ Evaluation of enabling devices</li> <li>■ 1- or 2-channel control, STOP 0</li> <li>■ For more information, visit <a href="http://www.schmersal.net">www.schmersal.net</a></li> </ul>

■ **Hauptsitz - Headquarters**  
**K.A. Schmersal GmbH & Co. KG**  
**Industrielle Sicherheitssysteme**  
 Postfach 24 02 63,  
 42232 Wuppertal  
 Möddinghofe 30  
 D-42279 Wuppertal  
 Phone: +49-(0) 2 02-64 74-0  
 Fax: +49-(0) 2 02-64 74-1 00  
 info@schmersal.com  
 www.schmersal.com

## Germany - Northern region

■ **Wettenberg**  
**K.A. Schmersal GmbH & Co. KG**  
**Regionalbüro Nord**  
 Im Ostpark 2  
 D-35435 Wettenberg  
 Phone: +49-(0) 6 41-98 48-5 75  
 Fax: +49-(0) 6 41-98 48-5 77  
 rbnord@schmersal.com

■ **Hamburg / Münster**  
**K.A. Schmersal GmbH & Co. KG**  
**Vertriebsbüro Hamburg**  
 Innungsstraße 3  
 D-21244 Buchholz i.d.N.  
 Phone: +49-(0) 41 81-9 22 0-0  
 Fax: +49-(0) 41 81-9 22 0-20  
 vbhamburg@schmersal.com

■ **Berlin**  
**KSA Komponenten der Steuerungs-  
 und Automatisierungstechnik GmbH**  
 Pankstr. 8-10 / Aufg. L  
 D-13127 Berlin  
 Phone: +49-(0) 30-47 48 24 00  
 Fax: +49-(0) 30-47 48 24 05  
 info@ksa-gmbh.de  
 www.ksa-gmbh.de

■ **Hannover**  
**ELTOP GmbH**  
 Robert-Bosch-Str. 8  
 D-30989 Gehrden  
 Phone: +49-(0) 51 08-92 73 20  
 Fax: +49-(0) 51 08-92 73 21  
 eltop@eltop.de  
 www.eltop.de

■ **Köln**  
**Stollenwerk**  
**Technisches Büro GmbH**  
 Scheuermühlenstr. 40  
 D-51147 Köln  
 Phone: +49-(0) 22 03-9 66 20-0  
 Fax: +49-(0) 22 03-9 66 20-30  
 info@stollenwerk.de  
 www.stollenwerk.de

■ **Siegen**  
**Siegfried Klein**  
**Elektro-Industrie-Verretungen**  
 In der Steinwiese 46  
 D-57074 Siegen  
 Phone: +49-(0) 2 71-67 78  
 Fax: +49-(0) 2 71-67 70  
 info@sk-elektrotechnik.de  
 www.sk-elektrotechnik.de

■ **Leipzig**  
**K.A. Schmersal GmbH & Co. KG**  
**Vertriebsbüro Leipzig**  
 Servicepark  
 Druckereistraße 4  
 D-04159 Leipzig  
 Phone: +49-(0) 3 41-4 87 34 50  
 Fax: +49-(0) 3 41-4 87 34 51  
 vbleipzig@schmersal.com

## Germany - Southern region

■ **Nürnberg**  
**K.A. Schmersal GmbH & Co. KG**  
**Regionalbüro Süd**  
 Lechstraße 21  
 D-90451 Nürnberg  
 Phone: +49-(0)9 11- 6 49 60 53  
 Fax: +49-(0)9 11-63 29 07 29  
 rbsued@schmersal.com

■ **Saarland**  
**Herbert Neundörfer Werks-  
 vertretungen GmbH & Co. KG**  
 Am Campus 5  
 D-66287 Göttingen  
 Phone: +49-(0) 68 25-95 45-0  
 Fax: +49-(0) 68 25-95 45-99  
 info@herbert-neundoerfer.de  
 www.herbert-neundoerfer.de

■ **Bayern Süd**  
**INGAM Ing. Adolf Müller GmbH**  
**Industrievertretungen**  
 Elly-Staegmeyr-Str. 15  
 D-80999 München  
 Phone: +49-(0) 89-8 12 60 44  
 Fax: +49-(0) 89-8 12 69 25  
 info@ingam.de  
 www.ingam.de

■ **Bietigheim**  
**K.A. Schmersal GmbH & Co. KG**  
**Technologiezentrum**  
 Pleidelsheimer Straße 15  
 74321 Bietigheim-Bissingen  
 Phone: +49-(0) 71 42-9 19 80 53  
 Fax: +49-(0) 71 42-9 13 45 94  
 tzbw@schmersal.com

## Europe

■ **Austria - Österreich**  
**AVS-Schmersal Vertriebs Ges. m.b.H.**  
 Biróstraße 17  
 1232 Wien  
 Phone: +43-(0) 1-6 10 28  
 Fax: +43-(0) 1-6 10 28-1 30  
 info@avs-schmersal.at  
 www.avs-schmersal.at

■ **Belgium - Belgien**  
**Schmersal Belgium NV/SA**  
 Nieuwlandlaan 16B  
 Industriezone B413  
 3200 Aarschot  
 Phone: +32-(0) 16-57 16 18  
 Fax: +32-(0) 16-57 16 20  
 info@schmersal.be  
 www.schmersal.be

■ **Bulgaria - Bulgarien**  
**CDL Sensorik OOD**  
 Stefan Caragea Street  
 No 10 Office 4  
 7002 Ruse City  
 Phone: +359-(0)0 40-7 35 16 55 25  
 Fax: +359-(0)0 40-2 69 25 33 44  
 office@cdlsensorik.com  
 www.cdlsensorik.com

■ **Croatia - Kroatien**  
**Tipteh Zagreb d.o.o.**  
 Pescanska 170  
 10000 Zagreb  
 Phone: +385-1-3 81 65 74  
 Fax: +385-1-3 81 65 77  
 tipteh.zagreb@zg.t-com.hr

■ **Czech Republic - Tschech. Republik**  
**MERCOM COMPONENTA s.r.o.**  
 Bechyňská 640  
 199 00 Praha 9 – Letňany  
 Phone: +4 20- 267 31 46 40-2  
 mercom@mercom.cz  
 www.mercom.cz  
 www.schmersal.cz

■ **Denmark - Dänemark**  
**Schmersal Danmark A/S**  
 Lautruphøj 1-3  
 2750 Ballerup  
 Phone: +45-70 20 90 27  
 Fax: +45-70 20 90 37  
 info@schmersal.dk  
 www.schmersal.dk

■ **Finland - Finnland**  
**Advantec Oy**  
 Äyritie 12 B  
 01510 Vantaa  
 Phone: +3 58-2 07 19 94 30  
 Fax: +3 58-9 35 05 26 60  
 advantec@advantec.fi  
 www.advantec.fi

■ **France - Frankreich**  
**Schmersal France**  
 BP 18 - 38181 Seyssins Cedex  
 8, rue Raoul Follereau  
 38180 Seyssins  
 Phone: +33-4 76 84 23 20  
 Fax: +33-4 76 48 34 22  
 info-fr@schmersal.com  
 www.schmersal.fr

■ **Greece - Griechenland**  
**Kalamarakis Sapounas S.A.**  
**Ionias & Neromilou**  
 PO Box 46566 Athens  
 13671 Chamomilos Acharnes  
 Athens  
 Phone: +30-(0) 210-2 40 60 00-6  
 Fax: +30-(0) 210-2 40 60 07  
 ksa@ksa.gr  
 www.ksa.gr

■ **Hungary - Ungarn**  
**NTK Ipari-Elektronikai és  
 Kereskedelmi Kft**  
 Mészáros L. u. 5.  
 9023 Győr  
 Phone: +36-(0) 96-52 32 68  
 Fax: +36-(0) 96-43 00 11  
 info@ntk-kft.hu  
 www.ntk-kft.hu

■ **Iceland - Island**  
**Reykjafell Ltd.**  
 Skipholt 35  
 125 Reykjavik  
 Phone: +354-5 88 60 10  
 Fax: +354-5 88 60 88  
 reykjafell@reykjafell.is

■ **Italy - Italien**  
**Schmersal Italia s.r.l.**  
 Via Molino Vecchio, 206  
 25010 Borgosatollo, Brescia  
 Phone: +39-0 30-2 50 74 11  
 Fax: +39-0 30-2 50 74 31  
 info@schmersal.it  
 www.schmersal.it

■ **Macedonia - Mazedonien**  
**Tipteh d.o.o. Skopje**  
 Ul. Jani Lukrovski br. 2/33  
 1000 Skopje  
 Phone: +389-70-39 94 74  
 Fax: +389-23-17 41 97  
 tipteh@on.net.mk

■ **Netherlands - Niederlande**  
**Schmersal Nederland B.V.**  
 Lorentzstraat 31  
 3846 AV Hardenwijk  
 Phone: +31 (0)3 41-43 25 25  
 Fax: +31 (0)3 41-42 52 57  
 info-nl@schmersal.com  
 www.schmersal.nl

■ **Norway - Norwegen**  
**Schmersal Norge**  
 Hoffsveien 92  
 0377 Oslo  
 Phone: +47-22 06 00 70  
 Fax: +47-22 06 00 80  
 info-no@schmersal.com  
 www.schmersal.no

■ **Poland - Polen**  
**Schmersal Polska Sp.j.**  
 ul. Baletowa 29  
 02-867 Warszawa  
 Phone: +48-(0) 22-8 16 85 78  
 Fax: +48-(0) 22-8 16 85 80  
 info@schmersal.pl  
 www.schmersal.pl

■ **Portugal - Portugal**  
**Schmersal Ibérica, S.L.**  
 Apartado 30  
 2626-909 Póvoa de Sta. Iria  
 Phone: +351 - 21 959 38 35  
 info-pt@schmersal.com  
 www.schmersal.pt

■ **Romania - Rumänien**  
**CD SENSORIC SRL**  
 Str. George Enescu 21  
 550248 Sibiu  
 Phone: +40-(0)2 69-25 33 33  
 Fax: +40-(0)2 69-25 33 44  
 proiecte@cdl.ro  
 www.cdl.ro

■ **Russia - Russland**  
**OOO AT electro Moskau**  
 ul. Avtosavodskaya 16-2  
 109280 Moskau  
 Phone: +7-(0) 49 5-9 21 44 25  
 Fax: +7-(0) 49 5-9 26 46 45  
 info@at-e.ru  
 www.at-e.ru

**OOO AT electro Petersburg**  
 Polytehnicheskaya str, d.9,B  
 194021 St. Petersburg  
 Phone: +7-(0) 81 2-7 03 08 17  
 Fax: +7-(0) 81 2-7 03 08 34  
 spb@at-e.ru

**AT- Electronics Ekaterinburg**  
 Bebelya str. 17, room 405  
 620034 Ekaterinburg  
 Phone: +7-(0) 34 3-2 45 22 24  
 Fax: +7-(0) 34 3-2 45 98 22  
 ural@at-e.ru

■ **Slovakia - Slowakei**  
**MERCOM COMPONENTA s.r.o.**  
 Bechyňská 640  
 199 00 Praha 9 – Letňany  
 Phone: +4 20-267 31 46 40-2  
 mercom@mercom.cz  
 www.mercom.cz  
 www.schmersal.cz

■ **Slovenia - Slowenien**  
**Tipteh d.o.o.**  
 Ulica Ivana Roba 21  
 1000 Ljubljana  
 Phone: +386-1-2 00 51 50  
 Fax: +386-1-2 00 51 51  
 info@tipteh.si  
 www.tipteh.si

■ **Spain - Spanien**  
**Schmersal Ibérica, S.L.**  
**Pol. Ind. La Masia**  
 Camí de les Cabòries, Nave 4  
 08798 Sant Cugat Seggarrues  
 Phone: +34 - 93 897 09 06  
 Fax: +34 - 93 396 97 50  
 info-es@schmersal.com  
 www.schmersal.es

■ **Sweden - Schweden**  
**Schmersal Nordiska AB**  
 F O Petersons gata 28  
 421 31 Västra Frölunda  
 Phone: +46-(0) 31-3 38 35 00  
 Fax: +46-(0) 31-3 38 35 39  
 info-se@schmersal.com  
 www.schmersal.se

■ **Switzerland - Schweiz**  
**Schmersal Schweiz AG**  
 Moosmattstraße 3  
 8905 Arni  
 Phone: +41-(0) 43-3 11 22 33  
 Fax: +41-(0) 43-3 11 22 44  
 info-ch@schmersal.com  
 www.schmersal.ch

- **Turkey - Türkei**  
**BETA Elektrik**  
**Okçumusa Caddesi**  
Anten Han No. 44  
34420 Karaköy / Istanbul  
Phone: +90-212-235 99 14  
Fax: +90-212-253 54 56  
info@betaelektrik.com  
www.betaelektrik.com
- **United Kingdom - Großbritannien**  
**Schmersal Ltd.**  
Sparrowhawk Close  
Enigma Business Park  
Malvern Worcestershire WR14 1GL  
Phone: +44-(0) 16 84-57 19 80  
Fax: +44-(0) 16 84-56 02 73  
support@schmersal.co.uk  
www.schmersal.co.uk
- ~ **Ukraine - Ukraine**  
**INCOMTECH-PROJECT Ltd**  
17-25, Hertsena St., of. 9  
04050 Kyiv Ukraine  
Phone: +38 044 486 2537  
www.i-p.com.ua/
- VBR Ltd.**  
41, Demiyivska Str.  
03040 Kyiv Ukraine  
Phone: +38 (044) 259 09 55  
Fax: +38 (044) 259 09 55  
office@vbr.com.ua  
www.vbr.com.ua/about\_en.htm
- Worldwide**
- **Argentina - Argentinien**  
**Condelectric S. A.**  
info@condelectric.com.ar  
www.condelectric.com.ar  
**ELECTRO-DOS**  
contacto@electro-dos.com.ar  
www.electro-dos.com.ar
- **Australia - Australien**  
**Control Logic Pty. Ltd.**  
25 Lavarack Avenue, PO Box 1456  
Eagle Farm, Queensland  
Phone: +61 (0)7 36 23 12 12  
Fax: +61 (0)7 36 23 12 11  
sales@control-logic.com.au  
www.control-logic.com.au
- ~ **Belarus - Weißrussland**  
**ZAO Eximelektro**  
Ribalko Str. 26-110  
BY-220033 Minsk, Belarus  
Phone: +375-17-298-44-11  
Fax: +375-17-298-44-22  
eximelektro@tut.by  
www.exim.by
- **Bolivia - Bolivien**  
**Bolivien International**  
**Fil-Parts**  
3er. Anillo, 1040, Frente al Zoo  
Santa Cruz de la Sierra  
Phone: +591 (3) 3 42 99 00  
presidente@filparts.com.bo  
www.filparts.com.bo
- **Brazil - Brasilien**  
**ACE Schmersal**  
**Eletroeletrônica Industrial LTDA**  
Rodovia Boituva - Porto Feliz, KM 12  
Jardim Esplanada - CEP: 18550-000,  
Boituva, SP  
Phone: +55-(0) 15-32 63-98 00  
Fax: +55-(0) 15-32 63-98 99  
export@schmersal.com.br  
www.schmersal.com.br
- **Ecuador - Ecuador**  
**SENSORTEC S.A**  
AV. Napo y Pinto Guzmán  
QUITO  
Phone: +593 091 40 27 65  
+593 095 04 86 11  
info@sensortecsa.com  
www.sensortecsa.com
- **Canada - Kanada**  
**Schmersal Canada LTD.**  
15 Regan Road Unit #3  
Brampton, Ontario L7A 1E3  
Phone: (905) 495-7540  
Fax: (905) 495-7543  
Info-ca@schmersal.com  
www.schmersalcanada.com
- **Chile - Chile**  
**Vitel S.A.**  
francisco@vitel.cl  
www.vitel.cl  
**SOLTEX**  
central@soltex.cl  
www.soltex.com.cl  
**INSTRUTEC**  
gcaceres@instrutec.cl  
www.instrutec.cl  
**OEG**  
jmp@oegggroup.com  
www.oegggroup.cl  
**EECOL INDUSTRIAL ELECTRIC**  
ventas@eecol.cl  
www.eecol.cl
- **PR China - VR China**  
**Schmersal Industrial**  
**Switchgear (Shanghai) Co. Ltd.**  
Wai Qing Song Road 5388  
201700 Shanghai / Qingpu  
Phone: +86-21-63 75 82 87  
Fax: +86-21-63 75 82 97  
sales@schmersal.com.cn  
www.schmersal.com.cn
- **Colombia - Kolumbien**  
**EQUIPELCO**  
aospina@equipelco.com  
www.equipelco.com  
**SAMCO**  
jvargas@samcoingenieria.com  
www.samcoingenieria.com
- **Guatemala - Guatemala**  
**PRESTELECTRO**  
AV Petapa 44-22,  
Zona 12; Cent. Com Florencia 01012  
Phone: +502 24 42-33 46  
Anabella.Barrios@prestelectro.com  
www.prestelectro.com
- **India - Indien**  
**Schmersal India Private Limited**  
Plot No G 7/1,  
Ranjangaon MIDC,  
Taluka Shirur,  
District Pune 412220, India  
Phone: +91 21 38 61 47 00  
Fax: +91 20 66 86 11 14  
info-in@schmersal.com  
www.schmersal.in
- **Indonesia - Indonesien**  
**PT. Wiguna Sarana Sejahtera**  
Jl. Daan Mogot Raya No. 47  
Jakarta Barat 11470  
Phone: +62-(0) 21-5 63 77 70-2  
Fax: +62-(0) 21-5 66 69 79  
email@ptwiguna.com  
www.ptwiguna.com
- **Israel - Israel**  
**A.U. Shay Ltd.**  
23 Imber St. Kiriat. Arie.  
P.O. Box 10049  
Petach Tikva 49222 Israel  
Phone: +9 72-3-9 23 36 01  
Fax: +9 72-3-9 23 46 01  
shay@uriel-shay.com  
www.uriel-shay.com
- **Japan - Japan**  
**Schmersal Japan Branch Office**  
3-39-8 Shoan, Suginami-ku  
Tokyo 167-0054  
Phone: +81-3-3247-0519  
Fax: +81-3-3247-0537  
safety@schmersal.jp  
www.schmersal.jp
- **Korea - Korea**  
**Mahani Electric Co. Ltd.**  
46, Nonhyeon-ro 67-gil,  
Gangnam-gu, Seoul 135-930, Korea  
Phone: +82-(0) 2-21 94-33 00  
Fax: +82-(0) 2-21 94-33 97  
yskim@mec.co.kr  
www.mec.co.kr
- ~ **Litauen/Estland/Lettlan d**  
**BOPALIT**  
Mus galite rasti:  
Baltų pr. 145, LT-47125, Kaunas  
Phone: +370 37 298989  
Phone: +370 37 406718  
infoboplalit.lt  
www.boplalit.lt
- **Malaysia - Malaysiaien**  
**Ingermark (M) SDN.BHD**  
No. 29, Jalan KPK 1/8  
Kawasan Perindustrian Kundang  
48020 Rawang, Selangor Darul Ehsan  
Phone: +6 03-60-34 27 88  
Fax: +6 03-60-34 21 88  
enquiry@ingermark.com
- **Mexico - Mexiko**  
**ISEL SA de CV**  
mario.c@isel.com.mx  
www.isel.com.mx  
**INNOVATIVE AUTOMOTION SOLUTIONS**  
ias@iasmx.com  
www.iasautomation.com.mx  
**EASA ENERGIA Y AUTOMATIZACIÓN**  
ias@iasmx.com  
www.iasautomation.com.mx  
**DINAMICA S.A de C.V**  
ias@iasmx.com  
www.iasautomation.com.mx  
**SIGRAMA S.A de C.V**  
ias@iasmx.com  
www.iasautomation.com.mx  
**VGR TECHNOLOGIES**  
ias@iasmx.com  
www.iasautomation.com.mx
- **New Zealand - Neuseeland**  
**Hamer Automation**  
85A Falsgrave Street  
Phillipstown  
Christchurch, New Zealand  
Phone: +64 (0)33 66 24 83  
Fax: +64 (0)33 79 13 79  
sales@hamer.co.nz  
www.hamer.co.nz
- **Pakistan - Pakistan**  
**eurotech JLT**  
Office No.3404, 34<sup>th</sup> Floor,  
HDS Tower, Sheikh Zayed Road,  
Jumeirah Lakes Towers (JLT),  
P.O.Box 643650, Dubai, UAE  
Phone: +9 71-4-4 21 46 00  
Fax: +9 71-4-4 21 46 01  
sales@eurotech.ae  
www.eurotech.ae
- **Paraguay - Paraguay**  
**Brasguay S.R.L.**  
R. Internaciona 07  
KM 14 ; Minga Guazu  
Phone: +595 (61) 583-418/218/577  
brasguay@brasguay.com.py  
www.brasguay.com.py
- **Peru - Peru**  
**Fametal S.A.**  
fametal@fametal.com  
www.fametal.com  
**AYD**  
informes@ayd.com.pe  
www.ayd.com.pe
- **Serbia/Montenegro -**  
**Serbien/Montenegro**  
**Tipteh d.o.o.**  
Toplice Milana 14A  
11050 Belgrade  
Phone: +3 81-(0)11-2 89 22 50  
Fax: +3 81-(0)11-3 01 83 26  
www.tipteh.rs
- **Singapore - Singapur**  
**Tong Sim Marine & Electric Co.**  
46 Kaki Bukit Crescent  
Kaki Bukit Techpark 1  
Singapore 416269  
Phone: +65-67 43 31 77  
Fax: +65-67 45 37 00  
tongsim@singnet.com.sg  
www.tongsim.com
- **South Africa - Südafrika**  
**A+A Dynamic Distributors (Pty) Ltd.**  
20 - 24 Augusta Road  
Regents Park  
2197 Booysens  
Phone: +27-11-6 81 59 00  
Fax: +27-11-4 35 13 18  
awkayser@iafrica.com
- **Taiwan - Taiwan**  
**Golden Leader Camel Ent. Co., Ltd.**  
No. 453-7, Pei Tun Rd.  
Taichung City 40648, Taiwan  
Phone: +886-4-22 41 29 89  
Fax: +886-4-22 41 29 83  
camel88@ms46.hinet.net  
www.leadercamel.com.tw
- **Thailand - Thailand**  
**M. F. P. Engineering Co. Ltd.**  
64-66 Buranasart Road  
Sanchoaporsva  
Bangkok 10200  
Phone: +66-2-2 26 44 00  
Fax: +66-2-2 25 67 68  
info@mfpthai.com  
www.mfpthai.com
- **United Arab Emirates -**  
**Vereinigte Arabische Emirate**  
**eurotech JLT**  
Office No.3404, 34<sup>th</sup> Floor,  
HDS Tower, Sheikh Zayed Road,  
Jumeirah Lakes Towers (JLT),  
P.O.Box 643650,  
Dubai, UAE  
Phone: +9 71-4-4 21 46 00  
Fax: +9 71-4-4 21 46 01  
sales@eurotech.ae  
www.eurotech.ae
- **USA - USA**  
**Schmersal Inc.**  
660 White Plains Road, Suite 160  
Tarrytown, NY 10591-9994  
Phone: +1-(0) 9 14-3 47-47 75  
Fax: +1-(0) 9 14-3 47-15 67  
infousa@schmersal.com  
www.schmersalusa.com
- **Uruguay - Uruguay**  
**Gliston S.A.**  
Pedernal 1896 – Of. 203  
Montevideo  
Phone: +598 (2) 2 00 07 91  
colmedo@gliston.com.uy  
www.gliston.com.uy
- **Venezuela - Venezuela**  
**EMI Equipos y Sistemas C.A.**  
Calle 10, Edf. Centro Industrial  
Martinisi, Piso 3, La Urbina  
Caracas  
Phone: +58 (212) 2 43 50 72  
ventas@emi-ve.com  
www.emi-ve.com
- **Vietnam - Vietnam**  
**Ingermark (M) Sdn Bhd, Rep Office**  
No. 10 Alley 1/34, Lane 1,  
Kham Thien Str.,  
Kham Thien Ward Dong Da Dist.,  
10000 Hanoi, Vietnam.  
Phone: +04-35 16 27 06  
Fax: +04-35 16 27 05  
ingvietn18@ymail.com  
www.ingermark.com



# The Schmersal Group

For many years the privately owned Schmersal Group has been developing and manufacturing products to enhance occupational safety. What started out with the development and manufacture of a very wide variety of mechanical and non-contact switchgear has now become the world's largest range of safety systems and solutions for the protection of man and machine. Over 1,500 employees in more than 50 countries around the world are developing safety technology solutions in close cooperation with our customers, thus contributing to a safer world.

Motivated by the vision of a safe working environment, the Schmersal Group's engineers are constantly working on the development of new devices and systems for every imaginable application and requirement of the different industries. New safety concepts require new solutions and it is necessary to integrate new detection principles and to discover new paths for the transmission and evaluation of the information provided by these principles. Furthermore, the set of ever more complex standards, regulations and directives relating to machinery safety also requires a change in thinking from the manufacturers and users of machines.

These are the challenges which the Schmersal Group, in partnership with machinery manufacturers, is tackling and will continue to tackle in the future.

## Product ranges



### Safe switching and monitoring

- Guard door monitoring safety switches
- Command devices with safety function
- Tactile safety devices
- Optoelectronic safety devices

### Safe signal processing

- Safety monitoring modules
- Safety controllers
- Safety bus systems

### Automation

- Position detection
- Command and signalling devices

## Industries



- Elevators and escalators
- Packaging
- Food
- Machine tools
- Heavy industry

## Services



- Application advice
- CE conformity assessment
- Risk assessment in accordance with the Machinery Directive
- Stop time measurements
- Training courses

## Competences



- Machine safety
- Automation
- Explosion protection
- Hygienic design

Precautions have been taken to assure accuracy of the information in this catalogue. Typographic or pictorial errors that are brought to our attention will be corrected in subsequent issues.

[www.schmersal.com](http://www.schmersal.com)



 **SCHMERSAL**  
Safe solutions for your industry

