

Datasheet - AZ 17-02ZRK-2243-5,0M

Safety switch with separate actuator / AZ 17



- Thermoplastic enclosure
- Small body
- 8 actuating planes
- 30 mm x 60 mm x 30 mm
- Multiple coding
- Long life
- Double-insulated 
- High level of contact reliability with low voltages and currents
- Not sensitive to dirty conditions by virtue of patented roller system
- Front cable entry
- Can be retro-fitted

(Minor differences between the printed image and the original product may exist!)

Ordering details

Product type description	AZ 17-02ZRK-2243-5,0M
Article number	101139551
EAN code	4030661282091
eCl@ss	27-27-26-02

Approval

Approval

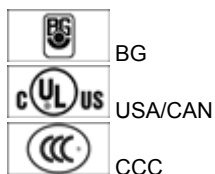

Classification

Standards	EN ISO 13849-1
B _{10d} Opener (NC)	2.000.000
Mission time	20 Years
notice	$MTTF_d = \frac{B_{10d}}{0,1 \times n_{op}}$ $n_{op} = \frac{d_{op} \times h_{op} \times 3600 \text{ s/h}}{t_{cycle}}$

Global Properties

Product name	AZ 17
Standards	EN 60947-5-1, BG-GS-ET-15
Materials	
- Material of the housings	Plastic, glass-fibre reinforced thermoplastic, self-extinguishing
- Material of the contacts	Silver
Housing coating	None
Weight	425 g

Mechanical data

Design of electrical connection	Cable
Cable output	front
Cable length	5 m
Conductors	4 x 0,75 mm ²
Mechanical life	> 1.000.000 operations
higher Latching force (Y/N)	Yes
Latching force	30 N
Positive break force	17 N
positive break travel	11 mm
Max. Actuating speed	2 m/s

Ambient conditions

Protection class	IP67 to IEC/EN 60529
------------------	----------------------

Electrical data

Design of control element	Opener (NC)
Switching principle	Creep circuit element
Number of auxiliary contacts	0 piece
Number of safety contacts	2 piece
Rated impulse withstand voltage U_{imp}	4 kV
Rated insulation voltage U_i	250 V
Thermal test current I_{the}	10 A
Utilisation category	AC-15: 230 V / 4 A DC-13: 24 V / 4 A
Max. fuse rating	6 A gG D-fuse

ATEX

Explosion protection categories for gases	None
Explosion protected category for dusts	None

Dimensions

Dimensions of the sensor	
- Width of sensor	30 mm
- Height of sensor	65 mm
- Length of sensor	30 mm

notice

Included in delivery

Actuators must be ordered separately.

Slot sealing plugs

Diagram

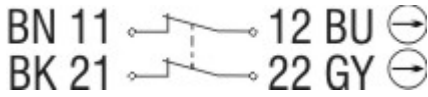

Note Diagram

positive break NC contact

active

no active

Normally-open contact

Normally-closed contact

Switch travel diagram



Notes Switch travel diagram

Contact closed

Contact open

Setting range

Break point

Positive opening sequence/- angle

VS adjustable range of NO contact

VÖ adjustable range of NC contact

N after travel

Ordering code

AZ 17-(1)Z(2)K-(3)-(4)-(5)

(1)	
11	Normally open contact (NO) 1 / Opener (NC) 1
02	Opener (NC) 2
(2)	
without	Latching force 5 N
R	Latching force 30 N
(3)	
without	cable gland M16
2243	Front cable entry
2243-1	Rear cable entry
ST	Connector M12, 4-pole
(4)	
1637	gold-plated contacts

(5)

5M

5 m Cable length

6M

6 m Cable length

Documents

Operating instructions and Declaration of conformity (pl) 490 kB, 18.11.2013

Code: mrl_az17_pl

Operating instructions and Declaration of conformity (ro) 511 kB, 25.01.2012

Code: mrl_az17_ro

Operating instructions and Declaration of conformity (sv) 488 kB, 17.06.2015

Code: mrl_az17_sv

Operating instructions and Declaration of conformity (jp) 1 MB, 17.11.2010

Code: mrl_az17_jp

Operating instructions and Declaration of conformity (it) 476 kB, 02.07.2013

Code: mrl_az17_it

Operating instructions and Declaration of conformity (da) 510 kB, 25.01.2012

Code: mrl_az17_da

Operating instructions and Declaration of conformity (es) 477 kB, 19.08.2013

Code: mrl_az17_es

Operating instructions and Declaration of conformity (de) 476 kB, 28.05.2013

Code: mrl_az17_de

Operating instructions and Declaration of conformity (en) 475 kB, 10.04.2013

Code: mrl_az17_en

Operating instructions and Declaration of conformity (fr) 479 kB, 29.07.2013

Code: mrl_az17_fr

Operating instructions and Declaration of conformity (nl) 479 kB, 02.07.2013

Code: mrl_az17_nl

Operating instructions and Declaration of conformity (pt) 496 kB, 11.03.2014

Code: mrl_az17_pt

Operating instructions and Declaration of conformity (cs) 511 kB, 27.02.2012

Code: mrl_az17_cs

BG-test certificate (en) 578 kB, 15.08.2011

Code: z_z17p02

BG-test certificate (de) 589 kB, 15.08.2011

Code: z_z17p01

CCC certification (cn) 408 kB, 24.06.2014

Code: q_175p03

CCC certification (en) 396 kB, 24.06.2014

Code: q_175p02

Gost certification (ru) 2 MB, 07.07.2011

Code: q_az1p01

Images



Product photo

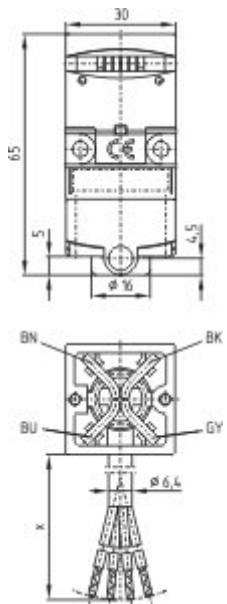

Dimensional drawing (basic component)

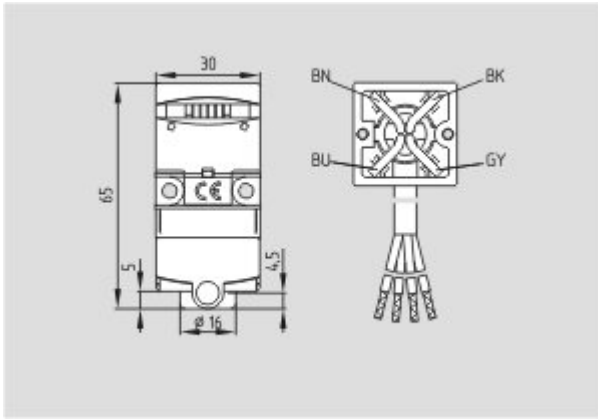

Dimensional drawing (basic component)

System components

Actuator



101122893 - AZ 17/170-B1

- Particularly suitable for sliding doors



101137406 - AZ 17/170-B1-2245

- Particularly suitable for sliding doors
- Damps vibration on guard device



101122895 - AZ 17/170-B5

- Particularly suitable for sliding doors



101126060 - AZ 17-B6

- For very small actuating radii
- The direction of actuation can be selected by applicable insertion of the insert



101139788 - AZ 17/170-B11

- Particularly suitable for sliding doors

101139789 - AZ 17/170-B15

- Particularly suitable for sliding doors



AZ 17-B25

- Ergonomic operation
- No supplementary door-handle required
- Door hinge on left-hand side (View point towards the hazardous area)
- No protruding actuator
- Actuator without handle
- Simple mounting
- Several door-handles available
- Possibility to mount the own handles using a default square screw (8 mm)

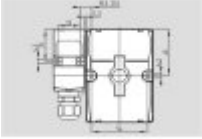

Accessories

101150363 - Mounting set MS AZ 17 P



101149212 - Mounting set MS AZ 17 R/P

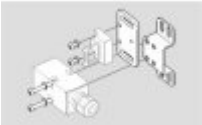

101208493 - AZM 170-B CENTERING GUIDE

- for AZ 17 and AZM 170



Mounting accessories

1135338 - TAMPERPROOF SCREWS M 5 x 12

- To mount the actuator
- Higher protection against tampering with interlock
- Protects against unauthorised removal of actuator
- Various lengths available



101135339 - TAMPERPROOF SCREWS M 5 x 16

- To mount the actuator
- Higher protection against tampering with interlock
- Protects against unauthorised removal of actuator
- Various lengths available



101135340 - TAMPERPROOF SCREWS M 5 x 20



- To mount the actuator
- Higher protection against tampering with interlock
- Protects against unauthorised removal of actuator
- Various lengths available

K.A. Schmersal GmbH & Co. KG, Möddinghofe 30, D-42279 Wuppertal

The data and values have been checked thoroughly. Technical modifications and errors excepted.

Generiert am 24.07.2015 - 21:31:34h Kasbase 3.1.12.F.64I