

Datasheet - AZ 17-02ZK

Safety switch with separate actuator / AZ 17



Preferred typ



- Thermoplastic enclosure
- Small body
- 8 actuating planes
- 30 mm x 60 mm x 30 mm
- Multiple coding
- Long life
- Double-insulated
- High level of contact reliability with low voltages and currents
- Not sensitive to dirty conditions by virtue of patented roller system
- cable gland M16

(Minor differences between the printed image and the original product may exist!)

Ordering details

Product type description	AZ 17-02ZK
Article number	101121961
EAN code	4030661049694
eCl@ss	27-27-26-02

Approval

Approval

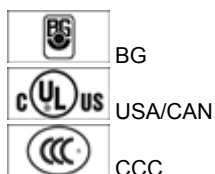

Classification

Standards	EN ISO 13849-1
B _{10d} Opener (NC)	2.000.000
Mission time notice	20 Years
	$MTTF_d = \frac{B_{10d}}{0,1 \times n_{op}}$
	$n_{op} = \frac{d_{op} \times h_{op} \times 3600 \text{ s/h}}{t_{cycle}}$

Global Properties

Product name	AZ 17
Standards	EN 60947-5-1, BG-GS-ET-15
Materials	
- Material of the housings	Plastic, glass-fibre reinforced thermoplastic, self-extinguishing
- Material of the contacts	Silver
Housing coating	None
Weight	85 g

Mechanical data

Design of electrical connection	IDC method of termination
Cable section	
- Min. Cable section	1 x 0,75 mm ²
- Max. Cable section	1 x 1 mm ²
Mechanical life	> 1.000.000 operations
higher Latching force (Y/N)	No
Latching force	5 N
Positive break force	17 N
positive break travel	11 mm
Max. Actuating speed	2 m/s

Ambient conditions

Protection class	IP67 to IEC/EN 60529
------------------	----------------------

Electrical data

Design of control element	Opener (NC)
Switching principle	Creep circuit element
Number of auxiliary contacts	0 piece
Number of safety contacts	2 piece
Rated impulse withstand voltage U_{imp}	4 kV
Rated insulation voltage U_i	250 V
Thermal test current I_{the}	10 A
Utilisation category	AC-15: 230 V / 4 A DC-13: 24 V / 4 A
Max. fuse rating	6 A gG D-fuse

ATEX

Explosion protection categories for gases	None
Explosion protected category for dusts	None

Dimensions

Dimensions of the sensor	
- Width of sensor	30 mm
- Height of sensor	85 mm
- Length of sensor	30 mm

notice

Individual coding available on request

This type termination (IDC) method enables simple connection of flexible conductors without the need for the use of conductor ferrules

Included in delivery



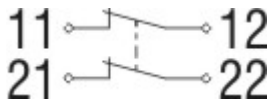

Actuators must be ordered separately.

Slot sealing plugs

Diagram





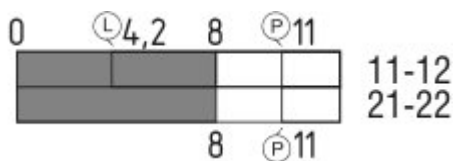

Note Diagram

-  positive break NC contact
-  active
-  no active
-  Normally-open contact
-  Normally-closed contact

Switch travel diagram



Notes Switch travel diagram

-  Contact closed
 -  Contact open
 -  Setting range
 -  Break point
 -  Positive opening sequence/- angle
- VS** adjustable range of NO contact
VÖ adjustable range of NC contact
N after travel

Ordering code

AZ 17-(1)Z(2)K-(3)-(4)-(5)

(1)	
11	Normally open contact (NO) 1 / Opener (NC) 1
02	Opener (NC) 2
(2)	
without	Latching force 5 N
R	Latching force 30 N
(3)	
without	cable gland M16
2243	Front cable entry
2243-1	Rear cable entry
ST	Connector M12, 4-pole

(4)

1637

gold-plated contacts

(5)

5M

5 m Cable length

6M

6 m Cable length

Documents

Operating instructions and Declaration of conformity (pl) 490 kB, 18.11.2013

Code: mrl_az17_pl

Operating instructions and Declaration of conformity (ro) 511 kB, 25.01.2012

Code: mrl_az17_ro

Operating instructions and Declaration of conformity (sv) 488 kB, 17.06.2015

Code: mrl_az17_sv

Operating instructions and Declaration of conformity (jp) 1 MB, 17.11.2010

Code: mrl_az17_jp

Operating instructions and Declaration of conformity (it) 476 kB, 02.07.2013

Code: mrl_az17_it

Operating instructions and Declaration of conformity (da) 510 kB, 25.01.2012

Code: mrl_az17_da

Operating instructions and Declaration of conformity (es) 477 kB, 19.08.2013

Code: mrl_az17_es

Operating instructions and Declaration of conformity (de) 476 kB, 28.05.2013

Code: mrl_az17_de

Operating instructions and Declaration of conformity (en) 475 kB, 10.04.2013

Code: mrl_az17_en

Operating instructions and Declaration of conformity (fr) 479 kB, 29.07.2013

Code: mrl_az17_fr

Operating instructions and Declaration of conformity (nl) 479 kB, 02.07.2013

Code: mrl_az17_nl

Operating instructions and Declaration of conformity (pt) 496 kB, 11.03.2014

Code: mrl_az17_pt

Operating instructions and Declaration of conformity (cs) 511 kB, 27.02.2012

Code: mrl_az17_cs

BG-test certificate (en) 578 kB, 15.08.2011

Code: z_z17p02

BG-test certificate (de) 589 kB, 15.08.2011

Code: z_z17p01

CCC certification (cn) 408 kB, 24.06.2014

Code: q_175p03

CCC certification (en) 396 kB, 24.06.2014

Code: q_175p02

Gost certification (ru) 2 MB, 07.07.2011

Code: q_az1p01

Images

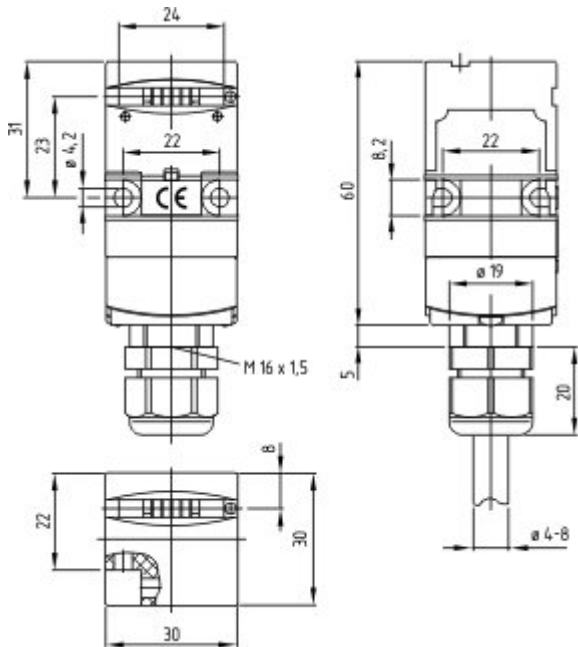

Dimensional drawing (basic component)

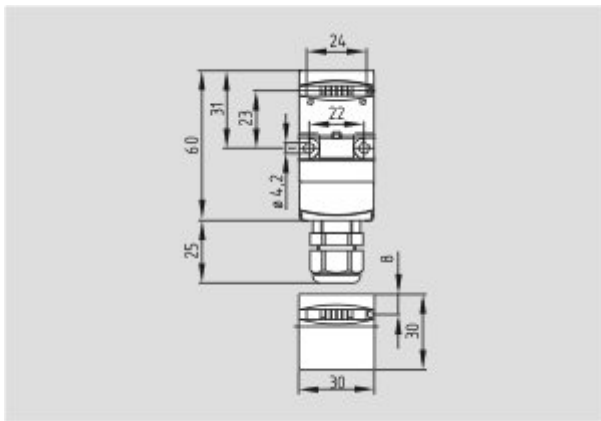

Dimensional drawing (basic component)

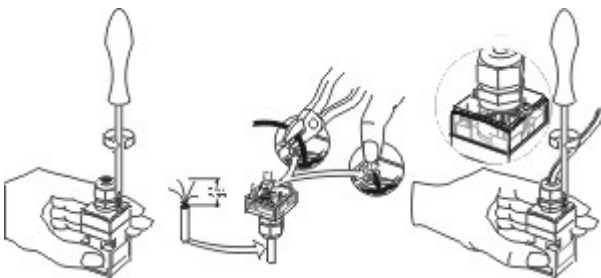

Configuration graphic

System components

Actuator



101122893 - AZ 17/170-B1

- Particularly suitable for sliding doors



101137406 - AZ 17/170-B1-2245

- Particularly suitable for sliding doors
- Damps vibration on guard device



101122895 - AZ 17/170-B5

- Particularly suitable for sliding doors



101126060 - AZ 17-B6

- For very small actuating radii
- The direction of actuation can be selected by applicable insertion of the insert



101139788 - AZ 17/170-B11

- Particularly suitable for sliding doors



101139789 - AZ 17/170-B15

- Particularly suitable for sliding doors

AZ 17-B25

- Ergonomic operation
 - No supplementary door-handle required
 - Door hinge on left-hand side (View point towards the hazardous area)
 - No protruding actuator
 - Actuator without handle
 - Simple mounting
 - Several door-handles available
 - Possibility to mount the own handles using a default square screw (8 mm)
-

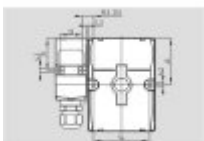

Accessories

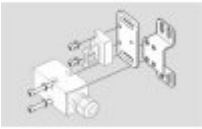

101150363 - Mounting set MS AZ 17 P

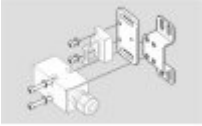

101149212 - Mounting set MS AZ 17 R/P



101208493 - AZM 170-B CENTERING GUIDE

- for AZ 17 and AZM 170

Mounting accessories



**1135338 - TAMPERPROOF SCREWS
M 5 x 12**

- To mount the actuator
- Higher protection against tampering with interlock
- Protects against unauthorised removal of actuator
- Various lengths available



101135339 - TAMPERPROOF SCREWS M 5 x 16

- To mount the actuator
- Higher protection against tampering with interlock
- Protects against unauthorised removal of actuator
- Various lengths available



101135340 - TAMPERPROOF SCREWS M 5 x 20

- To mount the actuator
- Higher protection against tampering with interlock
- Protects against unauthorised removal of actuator
- Various lengths available