

## Datasheet - AZ 17-02ZI-ST-B6L

Safety switch with separate actuator / AZ 17ZI / AZ 17/170ZI-B6L



(Minor differences between the printed image and the original product may exist!)

- left-hand model
- For very small actuating radii in line with or at 90° to the plane of the actuator
- Thermoplastic enclosure
- Double-insulated 
- Long life
- 30 mm x 60 mm x 30 mm
- Small body
- Individual coding
- High level of contact reliability with low voltages and currents
- Not sensitive to dirty conditions by virtue of patented roller system
- 8 actuating planes
- Slot sealing plug included
- Connector M12 x 1, 4-pole

### Ordering details

Product type description	AZ 17-02ZI-ST-B6L
Article number	101144087
EAN code	4030661130866
eCl@ss	27-27-26-02

### Approval

Approval



### Classification

Standards	EN ISO 13849-1
B <sub>10d</sub> Normally-closed contact (NC)	2.000.000
Mission time notice	20 Years
	$MTTF_d = \frac{B_{10d}}{0,1 \times n_{op}}$ $n_{op} = \frac{d_{op} \times h_{op} \times 3600 \text{ s/h}}{t_{cycle}}$

### Global Properties

---

Product name	AZ 17ZI
Standards	EN 60947-5-1, BG-GS-ET-15
Materials	
- Material of the housings	Plastic, glass-fibre reinforced thermoplastic, self-extinguishing
- Material of the actuator	Stainless steel
- Material of the contacts	Silver
Housing coating	None
Weight	115 g

### Mechanical data

---

Design of electrical connection	Connector M12
Mechanical life	> 1.000.000 operations
higher Latching force (Y/N)	No
Latching force	5 N
Positive break force	17 N
positive break travel	11 mm
Max. Actuating speed	2 m/s

### Ambient conditions

---

Ambient temperature	
- Min. environmental temperature	-30 °C
- Max. environmental temperature	+80 °C
Protection class	IP67 to IEC/EN 60529

### Electrical data

---

Design of control element	Opener (NC)
Switching principle	Creep circuit element
Number of auxiliary contacts	0 piece
Number of safety contacts	2 piece
Supply voltage	
- Min. supply voltage	
- Max. supply voltage	230 V
Rated impulse withstand voltage $U_{imp}$	4 kV
Rated insulation voltage $U_i$	250 V
Thermal test current $I_{the}$	10 A
Utilisation category	AC-15: 230 V / 4 A DC-13: 24 V / 4 A
Max. fuse rating	6 A gG D-fuse

### ATEX

---

Explosion protection categories for gases	None
Explosion protected category for dusts	None

### Dimensions

---

Dimensions of the sensor	
- Width of sensor	30 mm
- Height of sensor	85 mm
- Length of sensor	30 mm

## notice

---

Actuating radius adjustable, minimum 50 mm, using an hexagonal key wrench 2 mm A/F (a and b)

The axis of the hinge should be 11 mm above the top edge of the safety switch and in the same plane

The actuator is not available separately.

## Included in delivery

---

Not available as spare part

Included in delivery

- Individually coded actuator
- tamperproof screws
- Slot sealing plugs

## Diagram

---

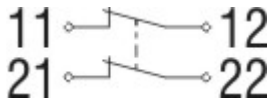

Note Diagram

- positive break NC contact
- active
- no active
- Normally-open contact
- Normally-closed contact

## Switch travel diagram

---



Notes Switch travel diagram

- Contact closed
- Contact open
- Setting range
- Break point
- Positive opening sequence/- angle
- VS** adjustable range of NO contact
- VÖ** adjustable range of NC contact
- N** after travel

## Ordering suffix

---

The applicable ordering suffix is added at the end of the part number of the safety switch.

Order example: AZ 17-02Z1-ST-B6L-**2243**

...-**2243**

Cable output: front

...-**2243 -1**

Cable output: rear

....-1637	0,3 µm gold-plated contacts
....-5M	Cable length 5 Meter
....-6M	Cable length 6 Meter

## Ordering code

---

AZ 17-(1)Z(2)I-(3)-(4)-(5)

<b>(1)</b>	
<b>11</b>	1 Normally open contact (NO) / 1 Opener (NC)
<b>02</b>	2 Opener (NC)
<b>(2)</b>	
<i>without</i>	Latching force 5 N
<b>R</b>	Latching force 30 N
<b>(3)</b>	
<i>without</i>	cable gland M16
<b>ST</b>	Connector M12
<b>(4)</b>	
<b>B1</b>	Actuator B1
<b>B5</b>	Actuator B5
<b>B6L</b>	Actuator B6L
<b>B6R</b>	Actuator B6R
<b>(5)</b>	
<b>1637</b>	gold-plated contacts

## Documents

---

**Operating instructions and Declaration of conformity (de)** 316 kB, 05.02.2014

Code: mrl\_az17-azm170-betaetiger\_de

**Operating instructions and Declaration of conformity (pl)** 157 kB, 11.03.2014

Code: mrl\_az17-azm170-betaetiger\_pl

**Operating instructions and Declaration of conformity (it)** 117 kB, 10.02.2014

Code: mrl\_az17-azm170-betaetiger\_it

**Operating instructions and Declaration of conformity (pt)** 116 kB, 23.05.2014

Code: mrl\_az17-azm170-betaetiger\_pt

**Operating instructions and Declaration of conformity (en)** 116 kB, 24.02.2014

Code: mrl\_az17-azm170-betaetiger\_en

**Operating instructions and Declaration of conformity (jp)** 171 kB, 03.04.2014

Code: mrl\_az17-azm170-betaetiger\_jp

**Operating instructions and Declaration of conformity (sv)** 115 kB, 17.06.2015

Code: mrl\_az17-azm170-betaetiger\_sv

**Operating instructions and Declaration of conformity (nl)** 116 kB, 11.03.2014

Code: mrl\_az17-azm170-betaetiger\_nl

**Operating instructions and Declaration of conformity (fr)** 117 kB, 03.04.2014

Code: mrl\_az17-azm170-betaetiger\_fr

**Operating instructions and Declaration of conformity (es)** 117 kB, 12.02.2014

Code: mrl\_az17-azm170-betaetiger\_es

**BG-test certificate (en)** 578 kB, 15.08.2011

Code: z\_z17p02

**BG-test certificate (de)** 589 kB, 15.08.2011

Code: z\_z17p01

**CCC certification (cn)** 408 kB, 24.06.2014

Code: q\_175p03

**CCC certification (en)** 396 kB, 24.06.2014

Code: q\_175p02

## Images

---

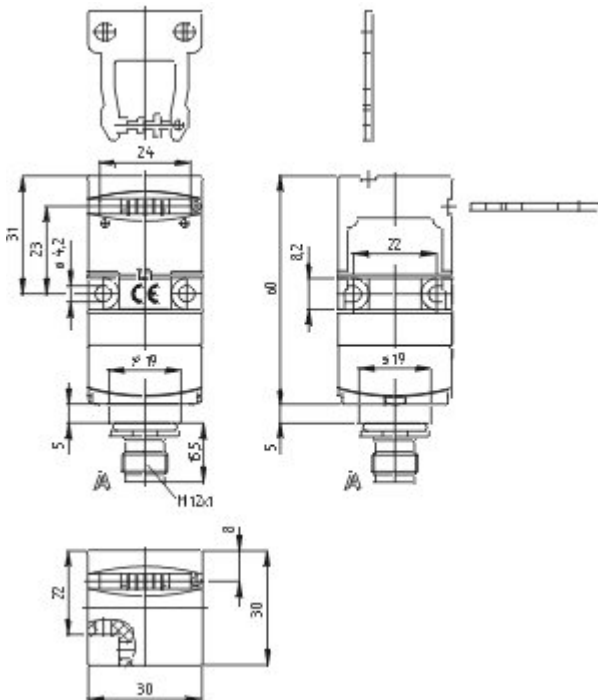

Dimensional drawing (basic component)

---

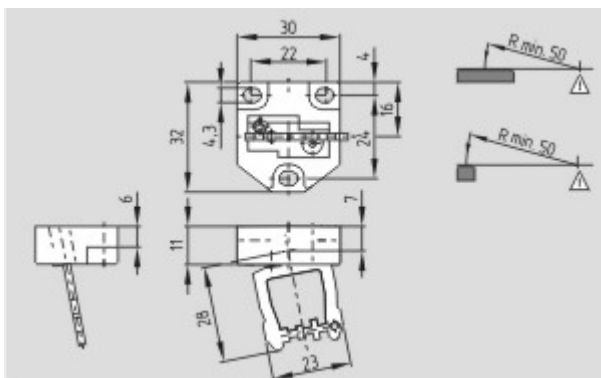

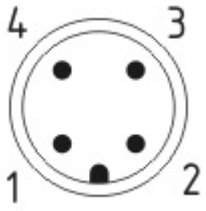

Contact arrangement

---

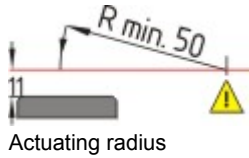

Actuating radius

---

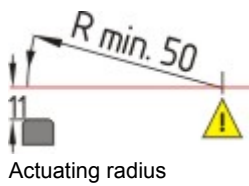

Actuating radius

---

## System components

---

### Connector



#### A-K4M12

- Pre-wired cable
- 4-pole



#### S-K4M12

- Connector without cable
- 4-pole