

## Datasheet - AZ 17-11ZRK-ST

Safety switch with separate actuator / AZ 17



Preferred typ



- Thermoplastic enclosure
- Small body
- 8 actuating planes
- 30 mm x 60 mm x 30 mm
- Multiple coding
- Long life
- Double-insulated
- High level of contact reliability with low voltages and currents
- Not sensitive to dirty conditions by virtue of patented roller system
- Connector M12 x 1, 4-pole

(Minor differences between the printed image and the original product may exist!)

### Ordering details

Product type description	AZ 17-11ZRK-ST
Article number	101140774
EAN code	4030661119731
eCl@ss	27-27-26-02

### Approval

Approval

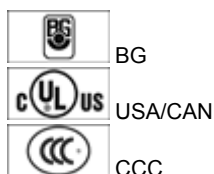

### Classification

Standards	EN ISO 13849-1
B <sub>10d</sub> Opener (NC)	2.000.000
B <sub>10d</sub> Normally open contact (NO)	1.000.000
- notice	at 10% I <sub>e</sub> and ohmic load
Mission time	20 Years
notice	

$$MTTF_d = \frac{B_{rod}}{0,1 \times n_{op}}$$

$$n_{op} = \frac{d_{op} \times h_{op} \times 3600 \text{ s/h}}{t_{cycle}}$$

## Global Properties

---

Product name	AZ 17
Standards	EN 60947-5-1, BG-GS-ET-15
Materials	
- Material of the housings	Plastic, glass-fibre reinforced thermoplastic, self-extinguishing
- Material of the contacts	Silver
Housing coating	None
Weight	85 g

## Mechanical data

---

Design of electrical connection	Connector M12
Mechanical life	> 1.000.000 operations
higher Latching force (Y/N)	Yes
Latching force	30 N
Positive break force	17 N
positive break travel	11 mm
Max. Actuating speed	2 m/s

## Ambient conditions

---

Protection class	IP67 to IEC/EN 60529
------------------	----------------------

## Electrical data

---

Design of control element	Normally open contact (NO), Opener (NC)
Switching principle	Creep circuit element
Number of auxiliary contacts	1 piece
Number of safety contacts	1 piece
Rated impulse withstand voltage $U_{imp}$	4 kV
Rated insulation voltage $U_i$	250 V
Thermal test current $I_{the}$	10 A
Utilisation category	AC-15: 230 V / 4 A DC-13: 24 V / 4 A
Max. fuse rating	6 A gG D-fuse

## ATEX

---

Explosion protection categories for gases	None
Explosion protected category for dusts	None

## Dimensions

---

Dimensions of the sensor	
- Width of sensor	30 mm
- Height of sensor	80.5 mm
- Length of sensor	30 mm

## notice

Individual coding available on request



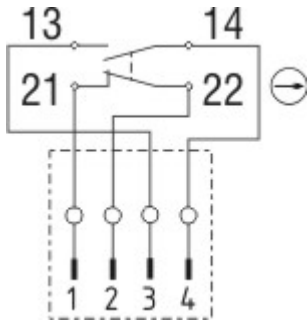

## Included in delivery

Actuators must be ordered separately.  
Slot sealing plugs

## Diagram





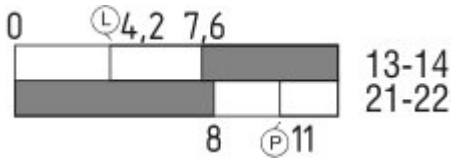

Note Diagram

-  positive break NC contact
-  active
-  no active
-  Normally-open contact
-  Normally-closed contact

## Switch travel diagram



Notes Switch travel diagram

-  Contact closed
-  Contact open
-  Setting range
-  Break point
-  Positive opening sequence/- angle
- VS** adjustable range of NO contact
- VÖ** adjustable range of NC contact
- N** after travel

## Ordering code

AZ 17-(1)Z(2)K-(3)-(4)-(5)

(1)	
11	Normally open contact (NO) 1 / Opener (NC) 1
02	Opener (NC) 2
(2)	
without	Latching force 5 N
R	Latching force 30 N

<b>(3)</b>		
<i>without</i>		cable gland M16
<b>2243</b>		Front cable entry
<b>2243-1</b>		Rear cable entry
<b>ST</b>		Connector M12, 4-pole
<b>(4)</b>		
<b>1637</b>		gold-plated contacts
<b>(5)</b>		
<b>5M</b>		5 m Cable length
<b>6M</b>		6 m Cable length

## Documents

---

**Operating instructions and Declaration of conformity (pl)** 490 kB, 18.11.2013

Code: mrl\_az17\_pl

**Operating instructions and Declaration of conformity (ro)** 511 kB, 25.01.2012

Code: mrl\_az17\_ro

**Operating instructions and Declaration of conformity (sv)** 488 kB, 17.06.2015

Code: mrl\_az17\_sv

**Operating instructions and Declaration of conformity (jp)** 1 MB, 17.11.2010

Code: mrl\_az17\_jp

**Operating instructions and Declaration of conformity (it)** 476 kB, 02.07.2013

Code: mrl\_az17\_it

**Operating instructions and Declaration of conformity (da)** 510 kB, 25.01.2012

Code: mrl\_az17\_da

**Operating instructions and Declaration of conformity (es)** 477 kB, 19.08.2013

Code: mrl\_az17\_es

**Operating instructions and Declaration of conformity (de)** 476 kB, 28.05.2013

Code: mrl\_az17\_de

**Operating instructions and Declaration of conformity (en)** 475 kB, 10.04.2013

Code: mrl\_az17\_en

**Operating instructions and Declaration of conformity (fr)** 479 kB, 29.07.2013

Code: mrl\_az17\_fr

**Operating instructions and Declaration of conformity (nl)** 479 kB, 02.07.2013

Code: mrl\_az17\_nl

**Operating instructions and Declaration of conformity (pt)** 496 kB, 11.03.2014

Code: mrl\_az17\_pt

**Operating instructions and Declaration of conformity (cs)** 511 kB, 27.02.2012

Code: mrl\_az17\_cs

**BG-test certificate (en)** 578 kB, 15.08.2011

Code: z\_z17p02

**BG-test certificate** (de) 589 kB, 15.08.2011

Code: z\_z17p01

**CCC certification** (cn) 408 kB, 24.06.2014

Code: q\_175p03

**CCC certification** (en) 396 kB, 24.06.2014

Code: q\_175p02

**Gost certification** (ru) 2 MB, 07.07.2011

Code: q\_az1p01

## Images

---

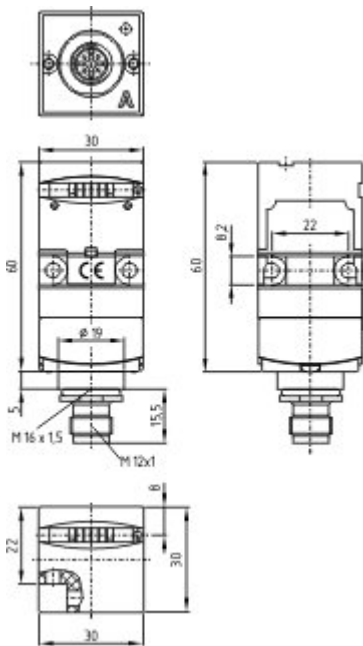

Dimensional drawing (basic component)

---

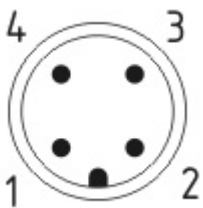

Contact arrangement

---

## System components

---

### Actuator



**101122893 - AZ 17/170-B1**

- Particularly suitable for sliding doors



**101137406 - AZ 17/170-B1-2245**

- Particularly suitable for sliding doors
- Damps vibration on guard device



**101122895 - AZ 17/170-B5**

- Particularly suitable for sliding doors



**101126060 - AZ 17-B6**

- For very small actuating radii
- The direction of actuation can be selected by applicable insertion of the insert



**101139788 - AZ 17/170-B11**

- Particularly suitable for sliding doors



**101139789 - AZ 17/170-B15**

- Particularly suitable for sliding doors

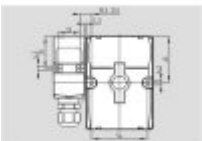

**AZ 17-B25**

- Ergonomic operation
- No supplementary door-handle required
- Door hinge on left-hand side (View point towards the hazardous area)
- No protruding actuator
- Actuator without handle
- Simple mounting
- Several door-handles available
- Possibility to mount the own handles using a default square screw (8 mm)

---

**Accessories**

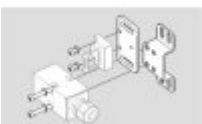

**101150363 - Mounting set MS AZ 17 P**

---

**101149212 - Mounting set MS AZ 17 R/P**

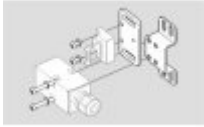

---

#### 101208493 - AZM 170-B CENTERING GUIDE

- for AZ 17 and AZM 170

---

#### Connector



#### A-K4M12

- Pre-wired cable
- 4-pole



#### S-K4M12

- Connector without cable
- 4-pole

---

#### Mounting accessories



#### 1135338 - TAMPERPROOF SCREWS M 5 x 12

- To mount the actuator
- Higher protection against tampering with interlock
- Protects against unauthorised removal of actuator
- Various lengths available



#### 101135339 - TAMPERPROOF SCREWS M 5 x 16

- To mount the actuator
- Higher protection against tampering with interlock
- Protects against unauthorised removal of actuator
- Various lengths available



#### 101135340 - TAMPERPROOF SCREWS M 5 x 20

- To mount the actuator
- Higher protection against tampering with interlock
- Protects against unauthorised removal of actuator
- Various lengths available