

## Datasheet - AZ 17-11ZRI-B6L

Safety switch with separate actuator / AZ 17ZI / AZ 17/170ZI-B6L



(Minor differences between the printed image and the original product may exist!)

- left-hand model
- For very small actuating radii in line with or at 90° to the plane of the actuator
- Thermoplastic enclosure
- Double-insulated 
- Long life
- 30 mm x 60 mm x 30 mm
- Small body
- Individual coding
- High level of contact reliability with low voltages and currents
- Not sensitive to dirty conditions by virtue of patented roller system
- 8 actuating planes
- Slot sealing plug included
- cable gland M16

### Ordering details

Product type description	AZ 17-11ZRI-B6L
Article number	101136307
EAN code	4030661280424
eCl@ss	27-27-26-02

### Approval

Approval



### Classification

Standards	EN ISO 13849-1
B <sub>10d</sub> Normally-closed contact (NC)	2.000.000
B <sub>10d</sub> Normally open contact (NO)	1.000.000
- notice	at 10% I <sub>e</sub> and ohmic load
Mission time	20 Years
notice	$MTTF_d = \frac{B_{10d}}{0,1 \times n_{op}}$

$$n_{op} = \frac{d_{op} \times h_{op} \times 3600 \text{ s/h}}{t_{cycle}}$$

### Global Properties

---

Product name	AZ 17ZI
Standards	EN 60947-5-1, BG-GS-ET-15
Materials	
- Material of the housings	Plastic, glass-fibre reinforced thermoplastic, self-extinguishing
- Material of the actuator	Stainless steel
- Material of the contacts	Silver
Housing coating	None
Weight	100 g

### Mechanical data

---

Design of electrical connection	IDC method of termination
Cable section	
- Min. Cable section	1 x 0,75 mm <sup>2</sup>
- Max. Cable section	1 x 1.0 mm <sup>2</sup> , flexible
Mechanical life	> 1.000.000 operations
higher Latching force (Y/N)	Yes
Latching force	30 N
Positive break force	17 N
positive break travel	11 mm
Max. Actuating speed	2 m/s

### Ambient conditions

---

Ambient temperature	
- Min. environmental temperature	-30 °C
- Max. environmental temperature	+80 °C
Protection class	IP67 to IEC/EN 60529

### Electrical data

---

Design of control element	Normally open contact (NO), Opener (NC)
Switching principle	Creep circuit element
Number of auxiliary contacts	1 piece
Number of safety contacts	1 piece
Supply voltage	
- Min. supply voltage	
- Max. supply voltage	230 V
Rated impulse withstand voltage U <sub>imp</sub>	4 kV
Rated insulation voltage U <sub>i</sub>	250 V
Thermal test current I <sub>the</sub>	10 A
Utilisation category	AC-15: 230 V / 4 A DC-13: 24 V / 4 A
Max. fuse rating	6 A gG D-fuse

### ATEX

---

Explosion protection categories for gases	None
Explosion protected category for dusts	None

### Dimensions

---

Dimensions of the sensor

- Width of sensor	30 mm
- Height of sensor	85 mm
- Length of sensor	30 mm

## notice

Actuating radius adjustable, minimum 50 mm, using an hexagonal key wrench 2 mm A/F (a and b)

The axis of the hinge should be 11 mm above the top edge of the safety switch and in the same plane

The actuator is not available separately.

This type termination (IDC) method enables simple connection of flexible conductors without the need for the use of conductor ferrules

## Included in delivery

Not available as spare part

Included in delivery

- Individually coded actuator
- tamperproof screws
- Slot sealing plugs

## Diagram



Note Diagram

- positive break NC contact
- active
- no active
- Normally-open contact
- Normally-closed contact

## Switch travel diagram

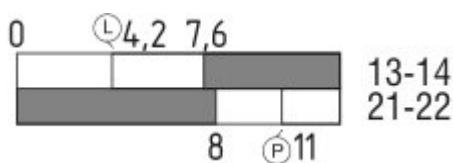

Notes Switch travel diagram

- Contact closed
- Contact open
- Setting range
- Break point
- Positive opening sequence/- angle
- VS** adjustable range of NO contact
- VÖ** adjustable range of NC contact
- N** after travel

## Ordering suffix

The applicable ordering suffix is added at the end of the part number of the safety switch.

Order example: AZ 17-11ZRI-B6L-**2243**

...-2243	Cable output: front
...-2243 -1	Cable output: rear
...-1637	0,3 µm gold-plated contacts
...-5M	Cable length 5 Meter
...-6M	Cable length 6 Meter

## Ordering code

---

AZ 17-(1)Z(2)I-(3)-(4)-(5)

<b>(1)</b>	
<b>11</b>	1 Normally open contact (NO) / 1 Opener (NC)
<b>02</b>	2 Opener (NC)
<b>(2)</b>	
<i>without</i>	Latching force 5 N
<b>R</b>	Latching force 30 N
<b>(3)</b>	
<i>without</i>	cable gland M16
<b>ST</b>	Connector M12
<b>(4)</b>	
<b>B1</b>	Actuator B1
<b>B5</b>	Actuator B5
<b>B6L</b>	Actuator B6L
<b>B6R</b>	Actuator B6R
<b>(5)</b>	
<b>1637</b>	gold-plated contacts

## Documents

---

**Operating instructions and Declaration of conformity (de)** 316 kB, 05.02.2014

Code: mrl\_az17-azm170-betaetiger\_de

**Operating instructions and Declaration of conformity (pl)** 157 kB, 11.03.2014

Code: mrl\_az17-azm170-betaetiger\_pl

**Operating instructions and Declaration of conformity (it)** 117 kB, 10.02.2014

Code: mrl\_az17-azm170-betaetiger\_it

**Operating instructions and Declaration of conformity (pt)** 116 kB, 23.05.2014

Code: mrl\_az17-azm170-betaetiger\_pt

**Operating instructions and Declaration of conformity (en)** 116 kB, 24.02.2014

Code: mrl\_az17-azm170-betaetiger\_en

**Operating instructions and Declaration of conformity (jp)** 171 kB, 03.04.2014

Code: mrl\_az17-azm170-betaetiger\_jp

**Operating instructions and Declaration of conformity (sv)** 115 kB, 17.06.2015

Code: mrl\_az17-azm170-betaetiger\_sv

**Operating instructions and Declaration of conformity (nl)** 116 kB, 11.03.2014

Code: mrl\_az17-azm170-betaetiger\_nl

**Operating instructions and Declaration of conformity (fr)** 117 kB, 03.04.2014

Code: mrl\_az17-azm170-betaetiger\_fr

**Operating instructions and Declaration of conformity (es)** 117 kB, 12.02.2014

Code: mrl\_az17-azm170-betaetiger\_es

**BG-test certificate (en)** 578 kB, 15.08.2011

Code: z\_z17p02

**BG-test certificate (de)** 589 kB, 15.08.2011

Code: z\_z17p01

**CCC certification (cn)** 408 kB, 24.06.2014

Code: q\_175p03

**CCC certification (en)** 396 kB, 24.06.2014

Code: q\_175p02

## Images

---

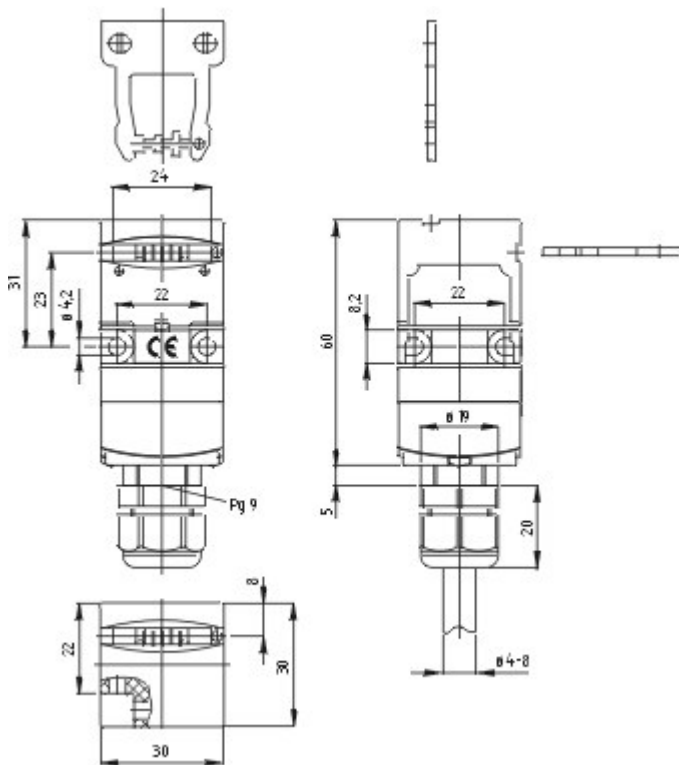

Dimensional drawing (basic component)

---

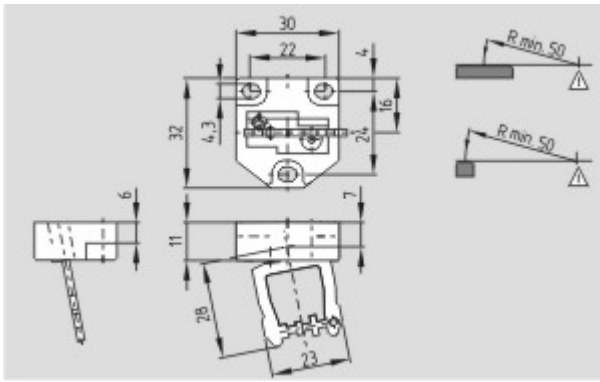

Dimensional drawing (miscellaneous)

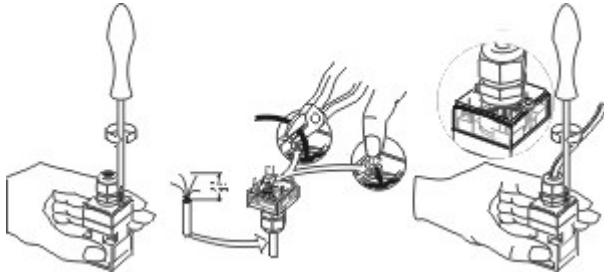

Configuration graphic

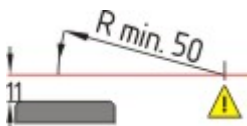

Actuating radius

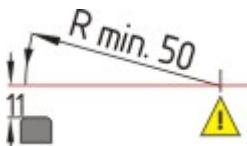

Actuating radius