



Description

The MZM 100 Series is designed for machine/work cells where access to a hazardous work area must be controlled until safe conditions exist. Their magnetic-latching feature permits locking a machine guard until dangerous conditions, which may exist immediately after removal of power, have abated.

The MZM 100 consists of a magnetic-latching interlock and actuator unit. An electromagnet is utilized to generate a 500 N holding force. An integrated pulse-echo based sensor detects and monitors the position of the safety guard. This sensor technology permits an offset between the actuator and interlock of ± 5 mm vertical and ± 3 mm horizontal.

The MZM100 magnetic-latching interlock is a dual channel design with two short-circuit proof, safe PNP outputs, each of which can switch up to 250 mA. The holding force is permanently electronically measured and monitored. If the holding force drops below 500 N, the safety outputs are not enabled, recognizing a dirty interlock.

With continuous internal function tests, the monitoring of the safety outputs and the use of door detection sensors, MZM 100 magnetic-latching interlocks can be wired in series without detriment to the control category. Series wired MZM 100s continue to fulfill the requirements of Control Category 4 according to EN 954-1 (without the need of a second switch).

Typical Applications

The MZM 100 is intended for use as a safety interlock switch on movable machine guards which must not be opened until dangerous conditions, which may exist after the removal of power, have abated. Such conditions are flywheel overrun, spindle momentum, unstable rest positions, etc. Typical applications are textile machines, stamping machines, food processing equipment, metal working equipment, wood working and packaging machines.

Features & Benefits

- **Magnetic-latching design** ... controls access to hazardous areas until safe conditions exist (100 lbs. locked holding force).
- **Forced-closed operating principle** ... no mechanical wear due to non-contact design.
- **Integral LED diagnostics** ... indicates operating states
- **Integral self-monitoring and door detection sensors** ... satisfy requirements of Safety Control Category 4.
**See Note Below.*
- **Designed for "daisy chaining"** ... up to 200 m.
- **Automatic magnetic latch (35 N)** ... no mechanical latching required ("r" version only).
- **Smooth surfaces allow for easy cleaning** ... ideal where high hygienic standards need to be maintained.
- **Dual PNP 250 mA safety outputs** ... for application versatility.

AVAILABLE MZM 100 MODELS & ACCESSORIES

(Accessories ordered separately)

Model Number	Description
Power to lock	
MZM100ST-1P2Pa	2-PNP safety outputs, 1 diagnostic output
MZM100ST-1P2Pra	2-PNP safety outputs, 1 diagnostic output, with latching
Accessories	
MZM100-B1	Actuator
MS MZM 100-W	Mounting Set
M23-9P	M23x1, 9 pin female connector
M23-9P-5m	M23x1, 9 pin female connector, 5 m cable

Safety Control Module Requirements

Dual-channel safety inputs, suitable for PNP semiconductor outputs. The internal function tests of the sensor cause the outputs to periodically switch off for a millisecond. This must be tolerated by the control module. The following SCHMERSAL safety control modules are recommended for this application: SRB 301 LCB, SRB 324 ST

*Note: A safety control module may be required for reset function and/or feedback monitoring functions, as well as increased output current requirements.

SERIES MZM 100 TECHNICAL DATA

MECHANICAL SPECIFICATIONS

Housing	Fiberglass reinforced thermoplastic
Degree of Protection	IP67
Unlocked Holding Force	35N (7 pounds) ("r" version only)
Magnetic Holding Force	500N (112 pounds)
Operating Temperature	-25°C to +55°C
Storage Temperature	-25°C to +85°C
Response Time	≤ 100ms
Vibration Resistance	10-55Hz, amplitude 1mm
Shock Resistance	30g/11ms
Mechanical Life	1 million operations
Mounting	40mm profiles
Conformity to Standards	CE BG EN 60947-5-1 UL/CSA EN 954-1 IEC 61508

ELECTRICAL SPECIFICATIONS

Mode of Operation	Magentic & Inductive
Rated Operating Voltage	24 VDC -15%/+10%
Rated Operating Current	1.0A
No Load Current	0.5A
Residual Current	≤ 0.5mA
Rated Impulse Withstand Voltage	0.8kV
Rated Insulation Voltage	32 VDC
Safety Outputs	(2) PNP, short-circuit proof
Safety Output Operating Current	0.25A per output
Safety Output Operating Voltage	Max. 4V below rated operating voltage
Signaling Output	PNP, short-circuit proof
Signaling Output Operating Current	Max. 0.05A
Signaling Output Operating Voltage	Max. 4V below rated operating voltage
Termination	Connector M23x1

DIMENSIONS

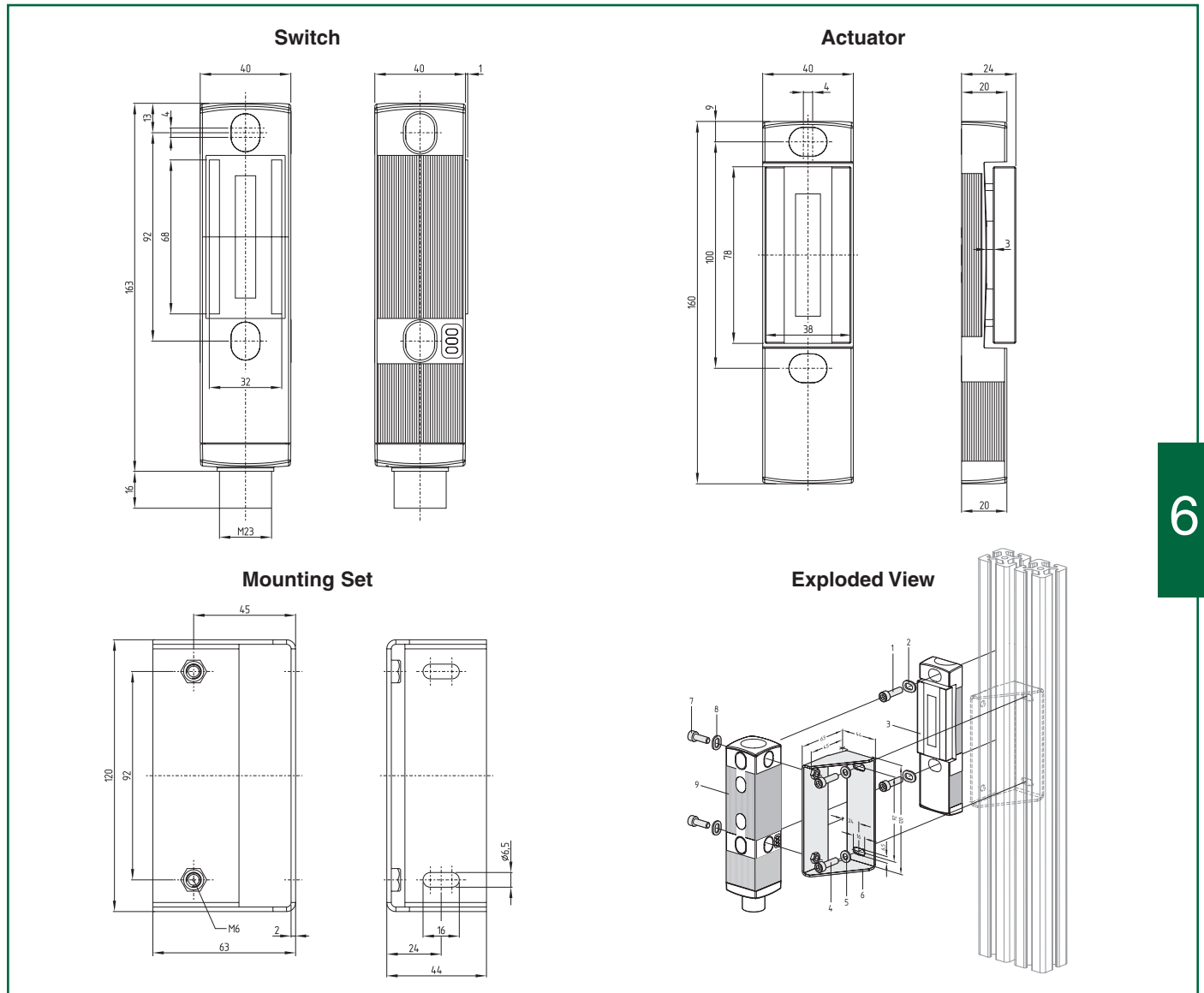

SERIES MZM 100 DIAGNOSTICS

Function table of visual diagnostic LED, electronic diagnostic output and safety outputs







State MZM 100	LED			Safety outputs Y1, Y2	Diagnostic output OUT
	green	yellow	red		
Guard open	on	off	off	0 V	0 V
Guard closed, unlocked	on	blinks	off	0 V	24 V
Guard closed and locked	on	on	off	24 V	24 V
Warning, door locked	on	on	blinks**	24 V*	0 V
Error, door locked	on	off	blinks**	0 V	0 V

* after 30 min. 0V

** see blinking code

Diagnostic LED error codes

The blinking sequence of the red LED of the MZM 100 identifies the active error. The following errors are indicated:

Indication (red)	Meaning
1 blinking impulse 	Error output Y1
2 blinking impulses 	Error output Y2
3 blinking impulses 	Cross-wire
5 blinking impulses 	Target error
6 blinking impulses 	Error holding force
10 blinking impulses 	Magnet is too hot
Continuous Red 	Internal Error

Blinking Codes (red)	Meaning	Autonomous switch-off after	Cause
1 blinking impulse	Error output Y1	30 min.	Error in output test or voltage at output "Y1", although the output is switched off
2 blinking impulses	Error output Y2	30 min.	Error in output test or voltage at output "Y2", although the output is switched off
3 blinking impulses	Cross-wire	30 min.	Cross-wire between the output cables or error at both outputs
5 blinking impulses	Target error	0 min.	The difference between the code (frequency) of the detected target and the set value is too large, false target
6 blinking impulses	Holding force error	0 min.	The required holding force is not obtained (misalignment/soiling). The holding force is < 500 N.
10 blinking impulses	Magnet temperature	0 min.	The magnet is too hot: Temperature is too high T>70°C
Continuous Red	Internal error	0 min.	

SERIES MZM 100 WIRING EXAMPLE

Safety Sensors in large systems

The sensors have separate input and output cables. The output of one sensor can be directly wired into the input of the next sensor. The sensor chain can be built up over a length of two hundred meters.

The supply voltage is wired in both safety inputs of the last solenoid interlock of the chain (starting from the control relay). The safety outputs of the first interlock are wired to the control relay.

SERIES CONNECTION OF MZM 100

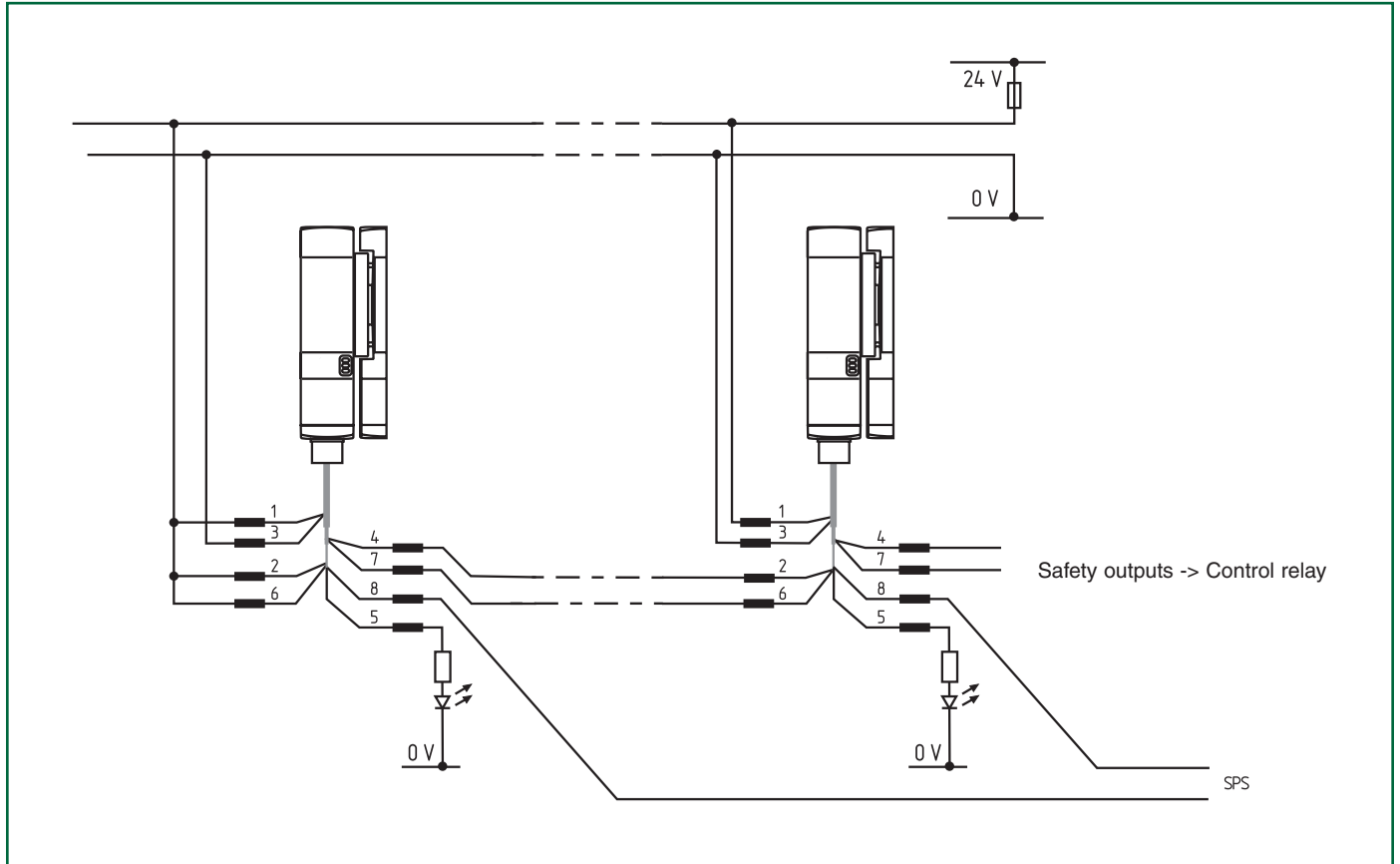

WIRING OF THE INTEGRATED CONNECTOR MZM 100

Solenoid interlock with diagnostic output	Pin configuration
A1 Supply Voltage	.Pin 1
A2 Ground	.Pin 3
X1 safety input 1	.Pin 2
X2 safety input 2	.Pin 6
Y1 safety output 1	.Pin 4
Y2 safety output 2	.Pin 7
OUT diagnostic output	.Pin 5
IN magnet control	.Pin 8

