

BALDOR® • **RELIANCE**

Product Information Packet

CEM3661T-5

3HP, 1755RPM, 3PH, 60HZ, 182TC, 0632M, TEFC, F1

Copyright © All product information within this document is subject to Baldor Electric Company copyright © protection, unless otherwise noted.

Part Detail									
Revision:	A	Status:	PRD/A	Change #:		Proprietary:	No		
Type:	AC	Prod. Type:	0632M	Elec. Spec:	06WGX319	CD Diagram:			
Enclosure:	TEFC	Mfg Plant:		Mech. Spec:	06F057	Layout:			
Frame:	182TC	Mounting:	F1	Poles:	04	Created Date:	10-10-2011		
Base:	RG	Rotation:	R	Insulation:	F	Eff. Date:	10-20-2011		
Leads:	3#16	Literature:		Elec. Diagram:		Replaced By:			
Nameplate NP1259L									
CAT.NO.	CEM3661T-5								
SPEC.	06F057X319G1								
HP	3								
VOLTS	575								
AMP	3.3								
RPM	1755								
FRAME	182TC	HZ	60			PH	3		
SER.F.	1.15	CODE	J			DES	B	CL	F
NEMA-NOM-EFF	89.5	PF	77						
RATING	40C AMB-CONT								
CC	010A	USABLE AT 208V							
DE	6206	ODE	6205						
ENCL	TEFC	SN							

Parts List		
Part Number	Description	Quantity
SA232423	SA 06F057X319G1	1.000 EA
RA219429	RA 06F057X319G1	1.000 EA
36FN3000C01SP	EXFN, PLASTIC, 5.25 OD, .912 ID	1.000 EA
S/P107-000-001	SUPER E PROC'S-FS & WS PLTS-POLYREX EM G	1.000 EA
HW3201A05	3/8-16 EYEBOLT	1.000 EA
06CB3000	CONDUIT BOX CAST	1.000 EA
06GS1000	GASKET, CONDUIT BOX	1.000 EA
51XW2520A12	.25-20 X .75, TAPTITE II, HEX WSHR SLTD	2.000 EA
11XW1032G06	10-32 X .38, TAPTITE II, HEX WSHR SLTD U	1.000 EA
HW3001B01	003SS CUP WASHER, FOR #8 SCREW	1.000 EA
36EP1101A21	FR ENDPLATE, MACH	1.000 EA
HW4500A01	1641B(ALEMITE)400 UNIV, GREASE FITT	1.000 EA
HW4500A17	317400 ALEMITE GREASE RELIEF	1.000 EA
HW5100A05	WVY WSHR F/205 & 304 BRGS	1.000 EA
36EP1300A13	PU ENDPLATE, MACH	1.000 EA
HW4500A01	1641B(ALEMITE)400 UNIV, GREASE FITT	1.000 EA
HW4500A17	317400 ALEMITE GREASE RELIEF	1.000 EA
10XN2520A26	1/4-20X 1 5/8 HEX HD	4.000 EA
HW1001A25	LOCKWASHER 1/4, ZINC PLT .493 OD, .255 I	4.000 EA
HA3101A34	THRUBOLT- 1/4-20 X 10.375	4.000 EA
51XB1214A16	12-14X1.00 HXWSSLD SERTYB	1.000 EA
36FH4009A31	IEC FH W/GREASER & SPL NOTCH, W/ AUTOPHE	1.000 EA
51XW1032A06	10-32 X .38, TAPTITE II, HEX WSHR SLTD S	3.000 EA
06CB3500	CONDUIT BOX LID - ALUMINUM DIE CAST	1.000 EA

Parts List (continued)		
Part Number	Description	Quantity
06GS1001	GASKET, CONDUIT BOX LID	1.000 EA
51XW2520A12	.25-20 X .75, TAPTITE II, HEX WSHR SLTD	2.000 EA
HW2501E16	3KEY, 1/4 SQ X 1.750	1.000 EA
HA7000A02	KEY RETAINER RING, 1 1/8 DIA, 1 3/8 DIA	1.000 EA
85XU0407S04	4X1/4 U DRIVE PIN STAINLESS	2.000 EA
LB1115	LABEL,LIFTING DEVICE	1.000 EA
MJ1000A75	GREASE, POLYREX EM EXXON	0.050 LB
MG1000Y03	WILKO 689.710 GOLD PAINT SUPER E	0.028 GA
LB1119	WARNING LABEL	1.000 EA
LB1125C02	SUPER-E (STOCK CTN LABEL SUPER-E WITH FL	1.000 EA
LC0006	CONNECTION LABEL	1.000 EA
LB1357	ENERGY GUIDE LABEL (BOX LABEL)	1.000 SH
NP1259L	ALUM SUPER-E UL CSA-EEV CC NEMA PREMIUM	1.000 EA
36PA1001	PACKAGING GROUP	1.000 EA

Performance Data at 575V, 60Hz, 3.0HP (Typical performance - Not guaranteed values)

General Characteristics							
Full Load Torque:	9.05 LB-FT			Start Configuration:	DOL		
No-Load Current:	1.7 Amps			Break-Down Torque:	33.0 LB-FT		
Line-line Res. @ 25°C.:	6.22 Ohms A Ph / 0.0 Ohms B Ph			Pull-Up Torque:	18.2 LB-FT		
Temp. Rise @ Rated Load:	35 C			Locked-Rotor Torque:	20.3 LB-FT		
Temp. Rise @ S.F. Load:	42 C			Starting Current:	23.8 Amps		
Load Characteristics							
% of Rated Load	25	50	75	100	125	150	S.F.
Power Factor:	38.0	59.0	71.0	77.0	81.0	83.0	79.0
Efficiency:	83.1	88.4	89.8	89.6	89.1	87.7	89.3
Speed:	1790.0	1779.0	1769.0	1757.0	1744.0	1730.0	1749.0
Line Amperes:	1.86	2.22	2.71	3.27	3.92	4.69	3.66

Performance Graph at 575V, 60Hz, 3.0HP Typical performance - Not guaranteed values

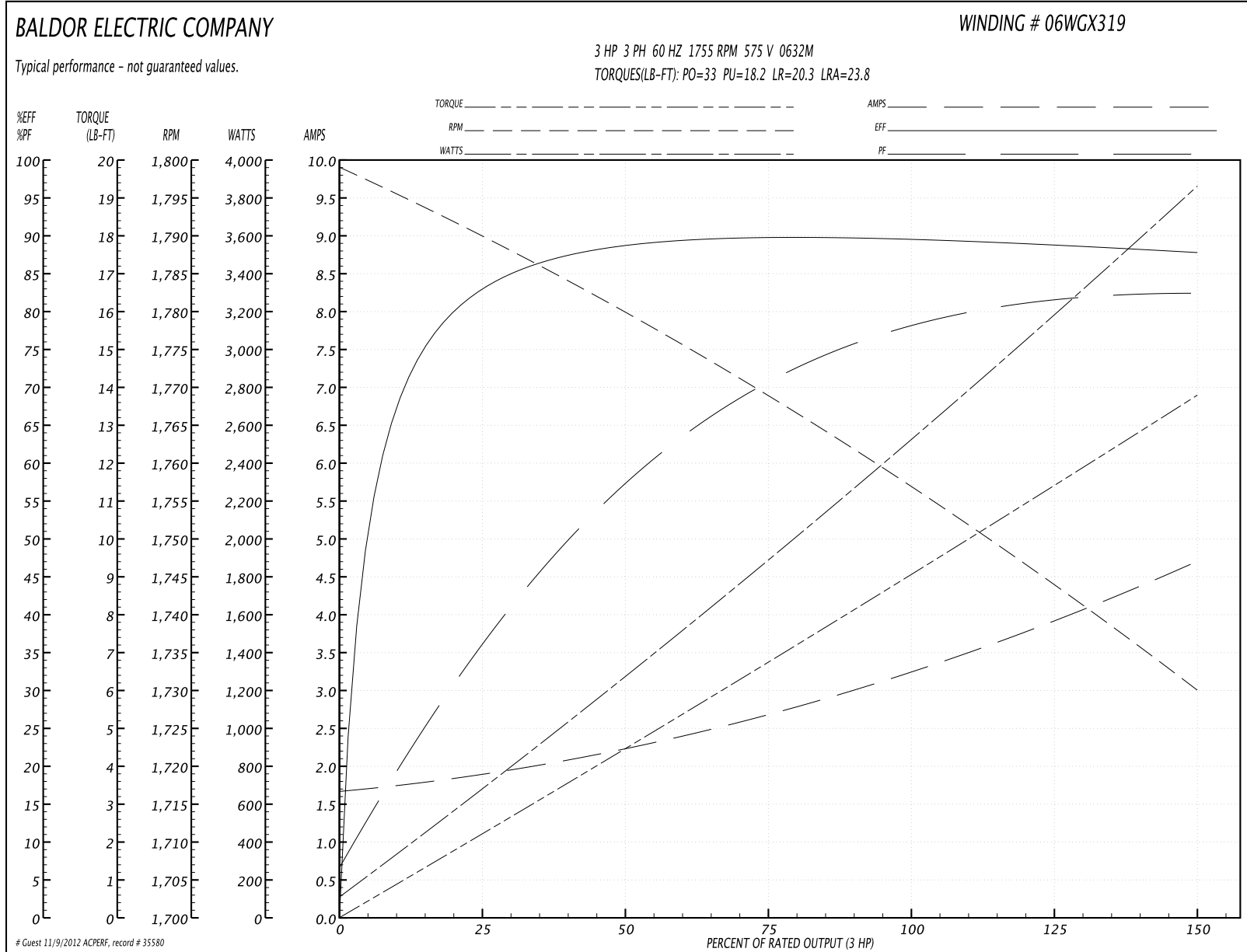

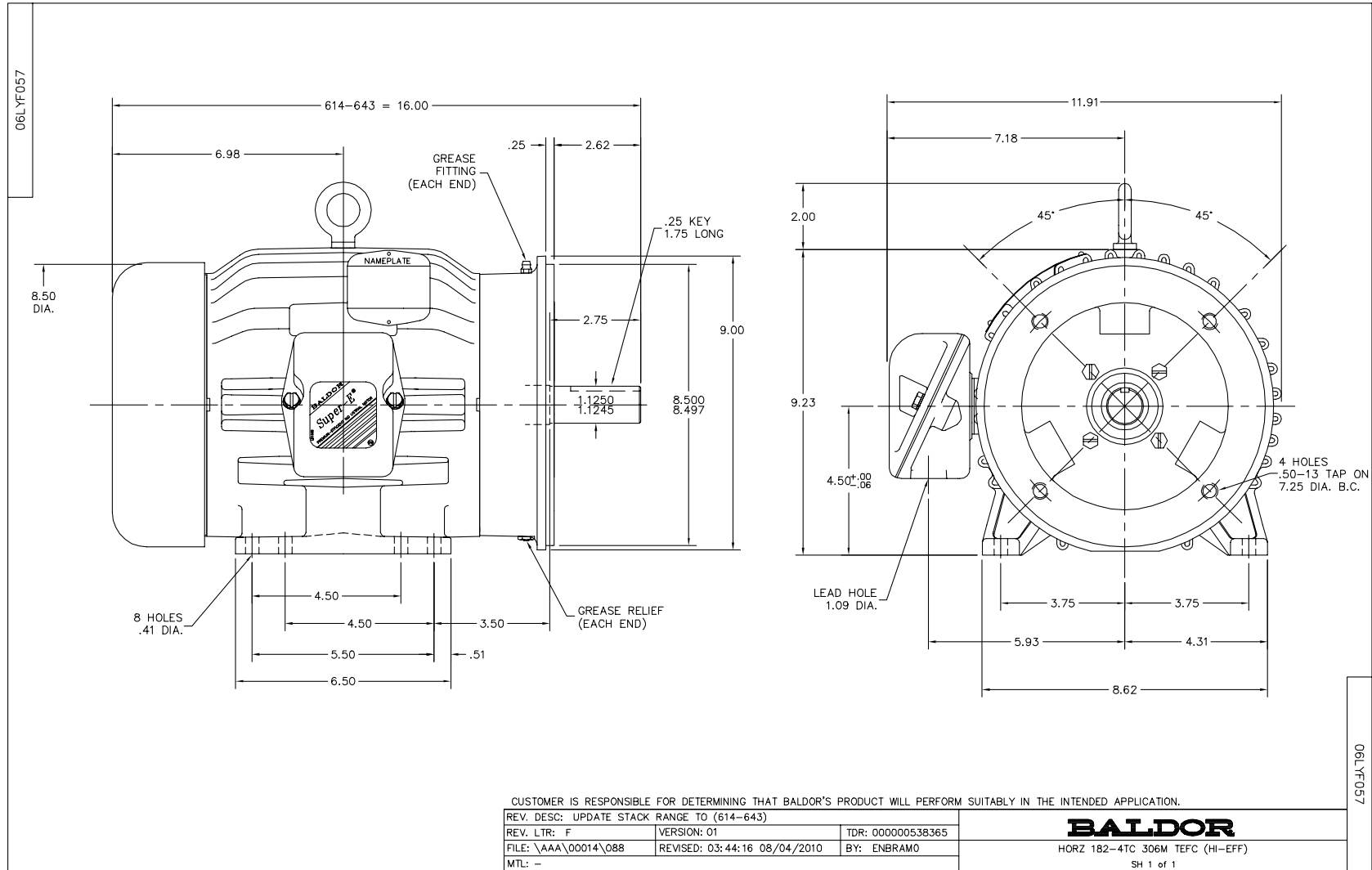

CD0006

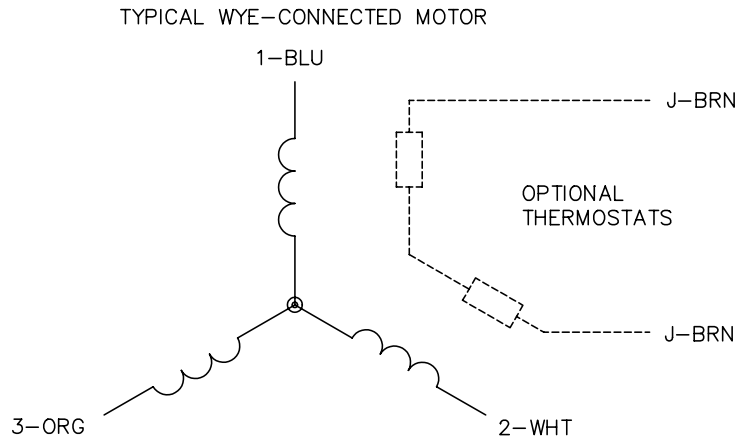

NOTES:

1. THREE LEAD MOTOR MAY BE EITHER WYE CONNECTED OR DELTA CONNECTED.
2. INTERCHANGE ANY TWO LINE LEADS TO REVERSE ROTATION.
3. OPTIONAL THERMOSTATS ARE PROVIDED WHEN SPECIFIED.
4. ACTUAL NUMBER OF INTERNAL PARALLEL CIRCUITS MAY VARY.
5. LEAD COLORS ARE OPTIONAL. LEADS MUST BE NUMBERED AS SHOWN.

REV. DESC: REVISE TO SHOW OPTIONAL COLORS			
REV. LTR: D	BY: JLP	REVISED: 01/21/99 4:02	TDR: 0171435
9000D		FILE: AAA00005141	MDL: -
		MTL: -	

BALDOR ELECTRIC Co.

3PH, SV, 3 LEADS, WYE OR DELTA CONNECTED

CD0006