

# **BALDOR**® • ***RELIANCE***

## **Product Information Packet**

# **CEWDM3556**

**1HP,1155RPM,3PH,60HZ,56C,3526M,TEFC,F1,N**

Copyright © All product information within this document is subject to Baldor Electric Company copyright © protection, unless otherwise noted.

Part Detail							
Revision:	A	Status:	PRD/A	Change #:		Proprietary:	No
Type:	AC	Prod. Type:	3526M	Elec. Spec:	35WGM497	CD Diagram:	
Enclosure:	TEFC	Mfg Plant:		Mech. Spec:	35S587	Layout:	
Frame:	56C	Mounting:	F1	Poles:	06	Created Date:	06-01-2011
Base:	RG	Rotation:	R	Insulation:	F	Eff. Date:	10-03-2012
Leads:	9#18	Literature:		Elec. Diagram:		Replaced By:	

**Nameplate NP1669L**

CAT.NO.	CEWDM3556						
SPEC.	35S587M497G1						
HP	1						
VOLTS	208-230/460						
AMP	3.6/1.8						
RPM	1155						
FRAME	56C	HZ	60	PH	3		
SER.F.	1.15	CODE	K	DES	B	CLASS	F
NEMA-NOM-EFF	82.5	PF	64				
RATING	40C AMB-CONT						
CC				USABLE AT 208V			
DE	6205	ODE	6203				
ENCL	TEFC	SN					
BLANK							

Parts List		
Part Number	Description	Quantity
SA224441	SA 35S587M497G1	1.000 EA
RA211552	RA 35S587M497G1	1.000 EA
35FN3002A05SP	EXFN, PLASTIC, 6.376 OD, .638 ID	1.000 EA
S/P107-000-001	SUPER E PROC'S-FS & WS PLTS-POLYREX EM G	1.000 EA
NS2512A01	INSULATOR, CONDUIT BOX X	1.000 EA
35GS1022A03SP	GASKET BOX .125 THK WHITE NEOPRENE	1.000 EA
51XB1016A07	10-16 X 7/16 HXWSSLD SERTYB	2.000 EA
11XW1032G06	10-32 X .38, TAPTITE II, HEX WSHR SLTD U	1.000 EA
HW4032A01	BLACK DRAIN PLUG FOR WASH DOWN MOTORS	3.000 EA
HW5100A03SP	WAVY WASHER (W1543-017)	1.000 EA
HW4032A01	BLACK DRAIN PLUG FOR WASH DOWN MOTORS	3.000 EA
HW4600B49SP	SEAL 0.938 X 1.624 X 0.250 SINGLE LIP DB	1.000 EA
12XN1032S20	10-32 X 1-1/4 HEX M.S. , STAINLESS STEEL	2.000 EA
51XB1214A16	12-14X1.00 HXWSSLD SERTYB	1.000 EA
35FH4005A01SP	IEC FH NO GREASER W/AUTOPHORETIC PRIMER	1.000 EA
11XW1032S06	10-32 X .38, TAPTITE II, HEX WSHR SLTD U	3.000 EA
35GS1030A02	35 GS FOR CB LID - WHITE NEOPRENE	1.000 EA
59XW0832S07	TAPTITE II,HEX WSHR UNSLTD SER,410 S.S.,	4.000 EA
HW1003S08	WASHER, #8 EX TH LK, SS	4.000 EA
HA1005A05SP	SLINGER, OD 1.50, ID .659, 203 BRG	1.000 EA
HW4600B46SP	SEAL 0.875 X 1.420 X 0.240 FACE SEALING	1.000 EA
HW2502D13	SS KEY, 3/16 SQ X 1.375	1.000 EA
HA7000A04	KEY RETAINER 0.625 DIA SHAFTS	1.000 EA
MJ5001A01	46-665 RED SEALER	0.001 QT

Parts List (continued)		
Part Number	Description	Quantity
85XU0407S04	4X1/4 U DRIVE PIN STAINLESS	2.000 EA
LB1164	LABEL,WARNING AND DRAIN	1.000 EA
HA5027A01	HA4066A01 T-DRAIN X2 BAGGED	1.000 EA
35CB3008A01W	35 CB .50 NPT @ 6, MACH WHITE EPOXY	1.000 EA
35EP3100A81MW	SPECIAL FRONT ENDPLATE, MACH. W/WHITE EP	1.000 EA
MJ1000A75	GREASE, POLYREX EM EXXON	0.050 LB
35EP3300A48MW	SPL FACE MTD EP - 205 BRG - W/SEAL FOR W	1.000 EA
35FN3002A05SP	EXFN, PLASTIC, 6.376 OD, .638 ID	1.000 EA
35CB4522	35 LIPPED CB LID AUTOPHORETIC	1.000 EA
MG1025Z20	ACTIVATOR WILKOFAS 060.32	0.010 GA
MG1025W11	PAINT- 781-101 WILKOFAS WHITE EPOXY	0.017 GA
HA3100S07	THRUBOLT 10-32 X 8.375 SS	4.000 EA
LB1125C02	SUPER-E (STOCK CTN LABEL SUPER-E WITH FL	1.000 EA
LC0005	CONN.DIA.,TY M,9-LD,DUAL VOLT,REVERSING	1.000 EA
LB1357	ENERGY GUIDE LABEL (BOX LABEL)	1.000 SH
NP1669L	SS WD SUPER-E UL CSA-EEV PREM REV MTG	1.000 EA
PA1000	PACKING GROUP 3500 SHORT	1.000 EA

**Performance Data at 460V, 60Hz, 1.0HP (Typical performance - Not guaranteed values)**

General Characteristics							
Full Load Torque:	4.51 LB-FT			Start Configuration:	DOL		
No-Load Current:	1.21 Amps			Break-Down Torque:	15.3 LB-FT		
Line-line Res. @ 25°C.:	16.42 Ohms A Ph / 0.0 Ohms B Ph			Pull-Up Torque:	11.1 LB-FT		
Temp. Rise @ Rated Load:	47 C			Locked-Rotor Torque:	11.9 LB-FT		
Temp. Rise @ S.F. Load:	56 C			Starting Current:	10.8 Amps		
Load Characteristics							
% of Rated Load	25	50	75	100	125	150	S.F.
Power Factor:	27.0	43.0	55.0	64.0	71.0	75.0	68.0
Efficiency:	69.0	79.4	82.3	82.7	82.0	80.4	82.3
Speed:	1190.4	1180.7	1170.3	1158.7	1145.5	1130.2	1151.0
Line Amperes:	1.25	1.36	1.53	1.75	2.02	2.33	1.91

Performance Graph at 460V, 60Hz, 1.0HP Typical performance - Not guaranteed values

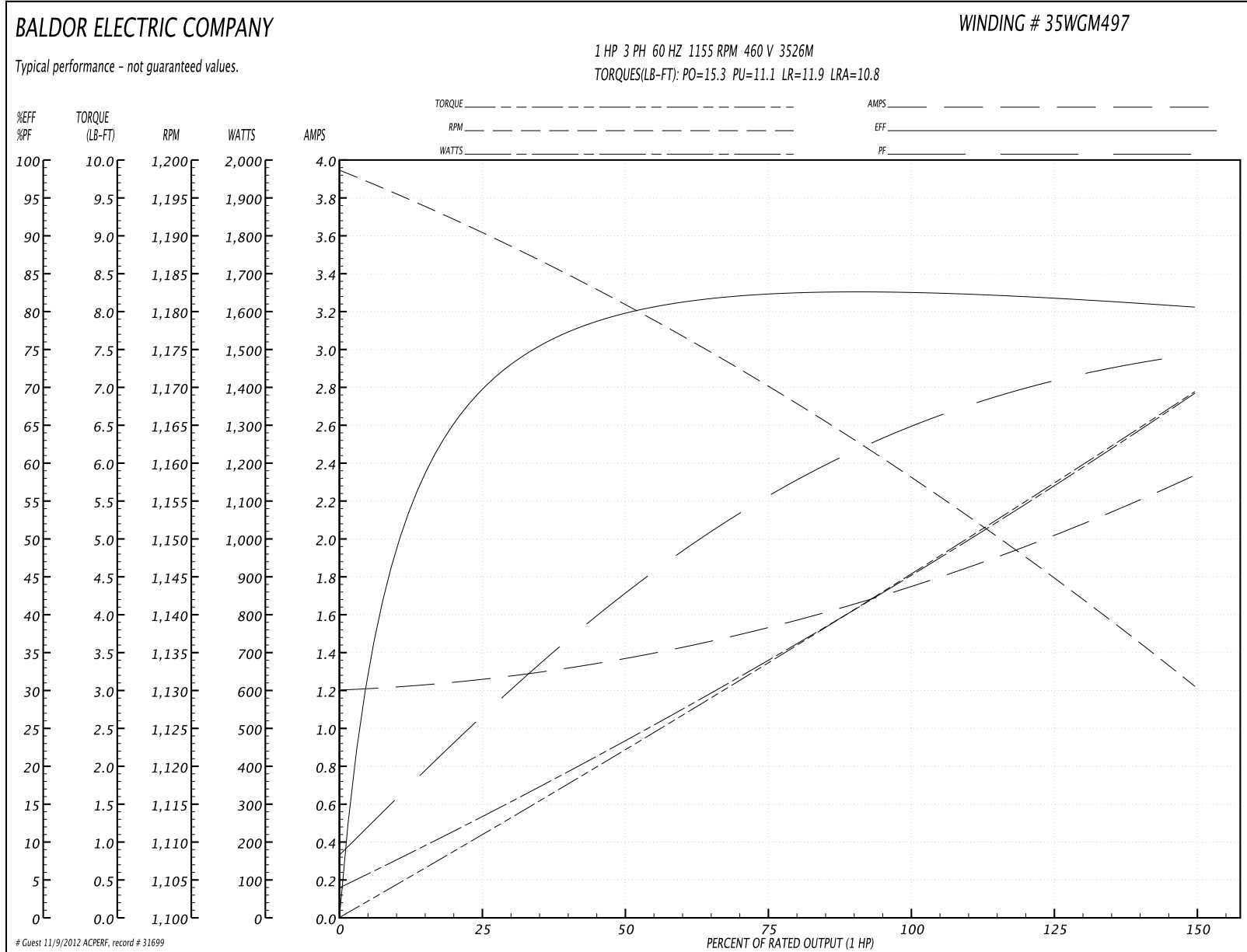

35LY5587

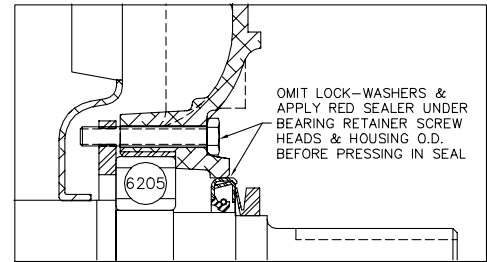
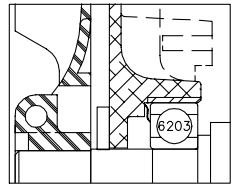
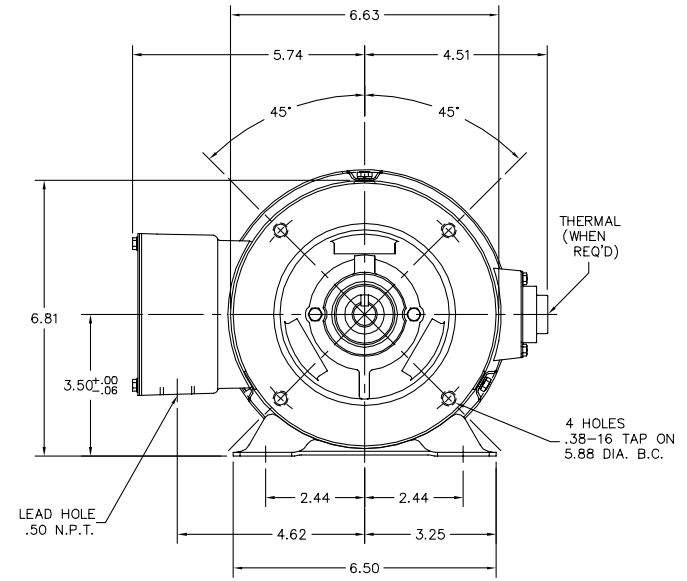
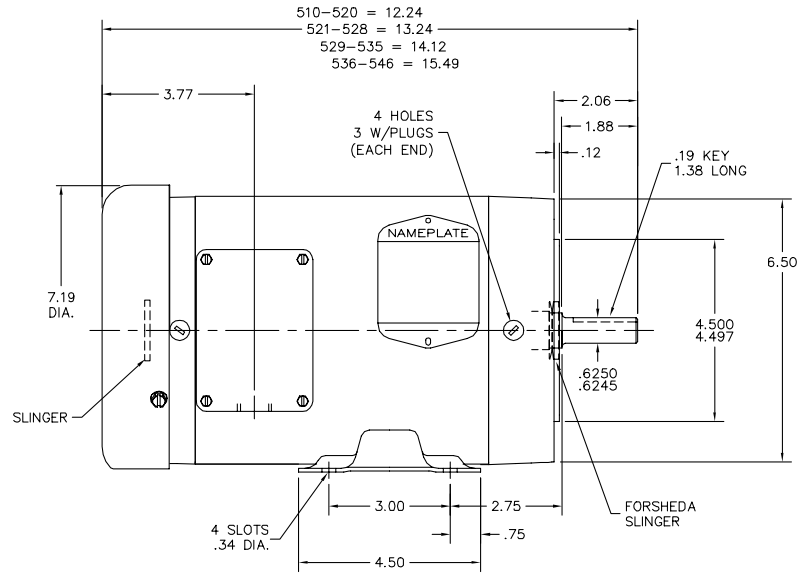

PULLEY END DETAIL

CUSTOMER IS RESPONSIBLE FOR DETERMINING THAT MOTOR PERFORMANCE IS SUITABLE IN THE APPLICATION.

REV. DESC: CORRECT DESCRIPTION		
REV. LTR: B	VERSION: 02	TDR: 000000428012
FILE: \AAA\00092\923	REVISED: 11:35:09 04/11/2007	BY: ENBRAMO
MTL: -		

**BALDOR ELECTRIC Co.**  
 STD HORZ 56C TEFC 35M WD (S/P #9)

35LY5587

CD0005

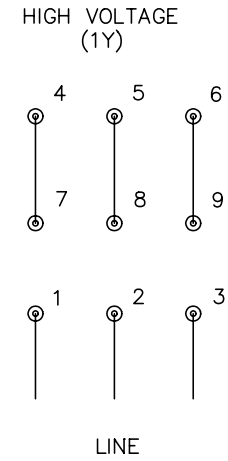
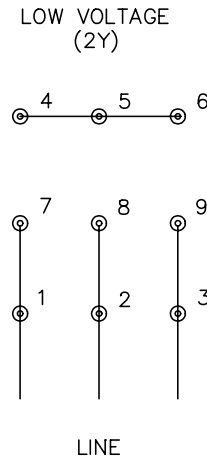

NOTES:

1. INTERCHANGE ANY TWO LINE LEADS TO REVERSE ROTATION.
2. OPTIONAL THERMOSTATS ARE PROVIDED WHEN SPECIFIED.
3. ACTUAL NUMBER OF INTERNAL PARALLEL CIRCUITS MAY BE A MULTIPLE OF THOSE SHOWN ABOVE.
4. LEAD COLORS ARE OPTIONAL. LEADS MUST ALWAYS BE NUMBERED AS SHOWN.

REV. DESC: REVISE TO SHOW OPTIONAL COLORS			
REV. LTR: E	BY: JLP	REVISED: 01/19/99 10:15	TDR: 0171435
90000		FILE: AAA00005140	MDL: -
		MTL: -	

**BALDOR ELECTRIC Co.**

3PH, DV, 9 LEADS

CD0005