

# **BALDOR**® • ***RELIANCE***

## **Product Information Packet**

# **EM2535T-12**

**30HP, 1770RPM, 3PH, 60HZ, 286T, 4052M, OPSB, F1**

Copyright © All product information within this document is subject to Baldor Electric Company copyright © protection, unless otherwise noted.

Part Detail							
Revision:	A	Status:	PRD/A	Change #:		Proprietary:	No
Type:	AC	Prod. Type:	4052M	Elec. Spec:	40WGW747	CD Diagram:	
Enclosure:	OPSB	Mfg Plant:		Mech. Spec:	40D101	Layout:	
Frame:	286T	Mounting:	F1	Poles:	04	Created Date:	01-25-2012
Base:	RG	Rotation:	R	Insulation:	F	Eff. Date:	03-14-2012
Leads:	12#10	Literature:		Elec. Diagram:		Replaced By:	

Nameplate NP2138L							
CAT.NO.	EM2535T-12	P/N		ENCLOSURE	OPSB		
SPEC.	40D101W747G1	CC	010A	FRAME	286T	S/N	
HP	30	CLASS	F	HZ	60		
RPM	1770	PH	3	DES	B		
VOLT	230/460	KVA-CODE	G	ODE BRG	6309	DE BRG	6311
AMP	70/35	USABLE AT 208V	74.1				
RATING	40C AMB-CONT	GREASE	POLYREX EM				
NEMA-NOM-EFF	94.1	PF	85	SER.F.	1.15		
HTR-VOLTS		HTR-AMPS		MAX. SPACE HEATER TEMP.			

Parts List		
Part Number	Description	Quantity
SA237872	SA 40D101W747G1	1.000 EA
RA224801	RA 40D101W747G1	1.000 EA
S/P107-000-004	SUPER-E(284 FR. & UP)-CL PLANT,POLYREX E	1.000 EA
HA6361A01	LIFTING LUG FOR 37, 39 & 40 FRAME (AUTOP	2.000 EA
HA6017A01	CAST ADAPTOR	1.000 EA
19XW3118A12	.31-18 X .75 HEX WASHER HEAD TAPTITE II	2.000 EA
HW1001A31	LOCKWASHER 5/16, ZINC PLT.591 OD, .319 I	2.000 EA
10CB3000SP	STD KO BOX MODEL 310,312,314 MTRS W/2.00	1.000 EA
19XW3118A12	.31-18 X .75 HEX WASHER HEAD TAPTITE II	4.000 EA
HW1001A31	LOCKWASHER 5/16, ZINC PLT.591 OD, .319 I	4.000 EA
WD1000B16	KPA-4C BURNDY TERMINAL	1.000 EA
51XF2520A08	SCREW, HEX SER SLT HD, ZN 1/4-20 X .50 L	1.000 EA
40EP3200A02	STD FREP OPEN 309 BRG	1.000 EA
HW5100A11	W3917-042 WVY WSHR (WB)	1.000 EA
40EP3200B05	STD PUEP OPEN 311 BRG	1.000 EA
XY3816A12	3/8-16 FINISHED NUT	8.000 EA
10CB3500SP	CONDUIT BOX LID, CAST	1.000 EA
51XW2520A12	.25-20 X .75, TAPTITE II, HEX WSHR SLTD	4.000 EA
HW2501H28	KEY, 1/2 SQ X 3.250	1.000 EA
LB1115	LABEL,LIFTING DEVICE	1.000 EA
LB5040	INSTRUCTION TAG, AC & DC	1.000 EA
HW4500A03	GREASE FITTING, .125 NPT 1610(ALEMITE) 8	1.000 EA
HW4500A20	1/8NPT SL PIPE PLUG	1.000 EA
HA4051A00	PLASTIC CAP FOR GREASE FITTING	1.000 EA

Parts List (continued)		
Part Number	Description	Quantity
MJ1000A75	GREASE, POLYREX EM EXXON	0.050 LB
HW4500A03	GREASE FITTING, .125 NPT 1610(ALEMITE) 8	1.000 EA
HW4500A20	1/8NPT SL PIPE PLUG	1.000 EA
HA4051A00	PLASTIC CAP FOR GREASE FITTING	1.000 EA
MG1000Y03	WILKO 689.710 GOLD PAINT SUPER E	0.070 GA
85XU0407A04	#4-7 X 1/4 DRIVE PIN	4.000 EA
40AD2002A01	LEXAN BAFFLE 40 FR OPEN	1.000 EA
40AD2002A01	LEXAN BAFFLE 40 FR OPEN	1.000 EA
HA3154A04	THRUBOLT STUD 3/8-16 X 18.750	4.000 EA
LB1119	WARNING LABEL	1.000 EA
LB1125C02	SUPER-E (STOCK CTN LABEL SUPER-E WITH FL	4.000 EA
LB1357	ENERGY GUIDE LABEL (BOX LABEL)	1.000 SH
LC0104A01	CONNECTION DIAGRAM	1.000 EA
NP2138L	ALUM SUPER-E UL CSA-EEV PREM CC (300	1.000 EA
40PA1000	PACKAGING GROUP	1.000 EA

**Performance Data at 460V, 60Hz, 30.0HP (Typical performance - Not guaranteed values)**

General Characteristics			
Full Load Torque:	88.9 LB-FT	Start Configuration:	DOL
No-Load Current:	13.5 Amps	Break-Down Torque:	274.0 LB-FT
Line-line Res. @ 25°C.:	0.219 Ohms A Ph / 0.0 Ohms B Ph	Pull-Up Torque:	128.0 LB-FT
Temp. Rise @ Rated Load:	31 C	Locked-Rotor Torque:	150.0 LB-FT
Temp. Rise @ S.F. Load:	38 C	Starting Current:	225.0 Amps

Load Characteristics							
% of Rated Load	25	50	75	100	125	150	S.F.
Power Factor:	50.0	72.0	82.0	85.0	86.0	86.0	86.0
Efficiency:	90.1	93.7	94.2	94.1	93.5	92.6	93.7
Speed:	1792.0	1785.0	1777.0	1769.0	1761.0	1752.0	1764.0
Line Amperes:	15.6	20.9	27.5	35.0	43.1	52.1	39.9

Performance Graph at 460V, 60Hz, 30.0HP Typical performance - Not guaranteed values

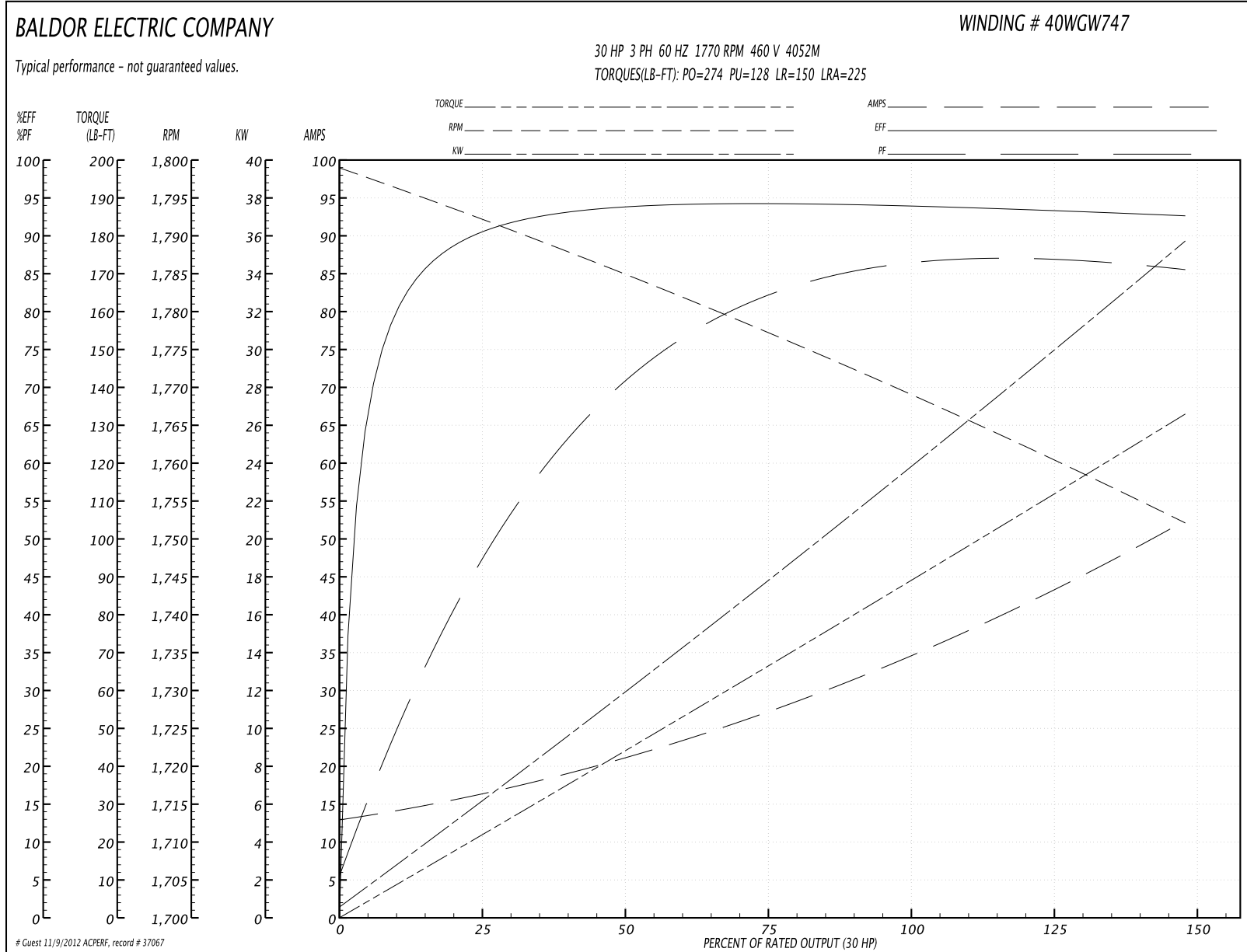

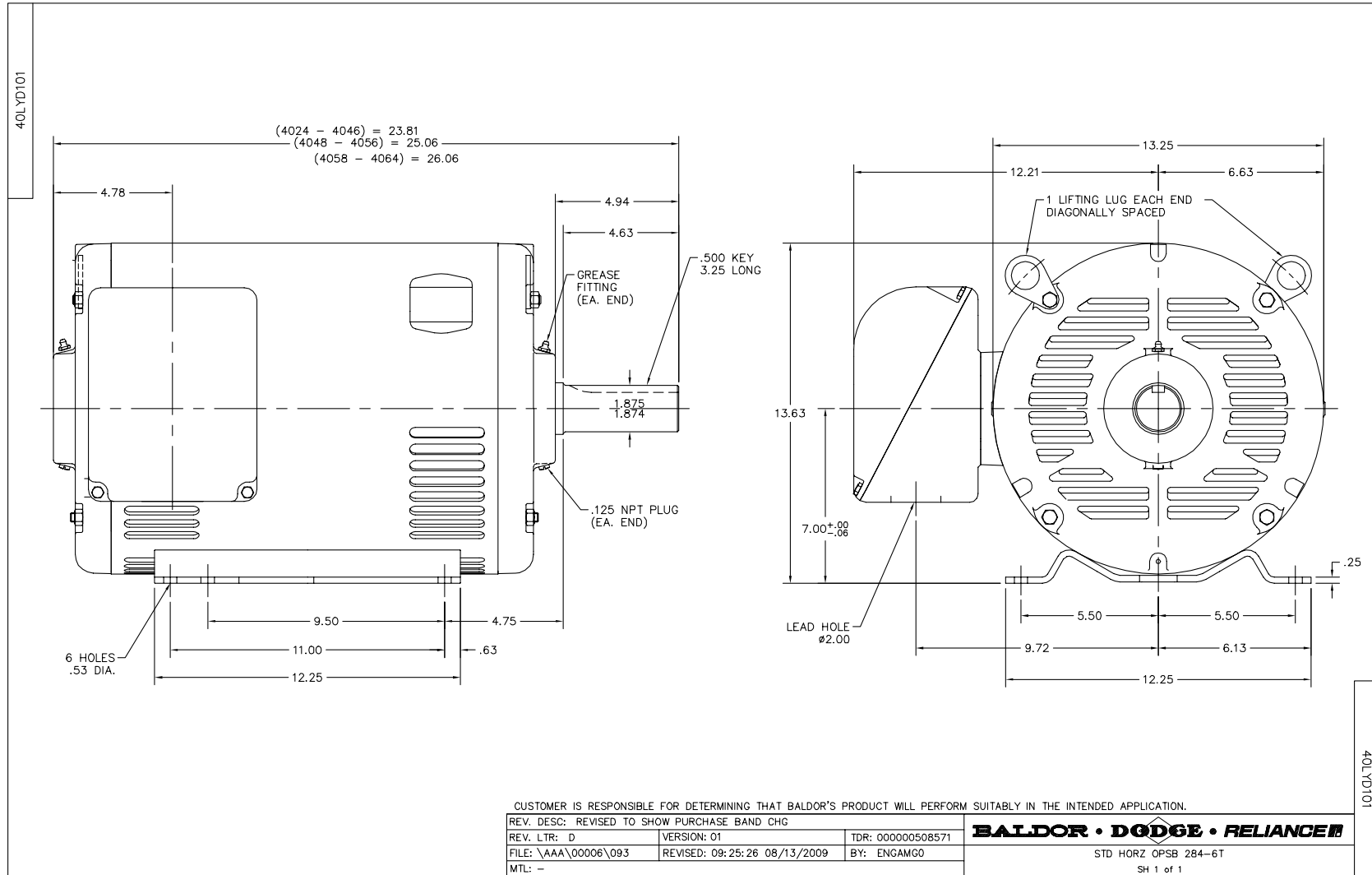

CD0104

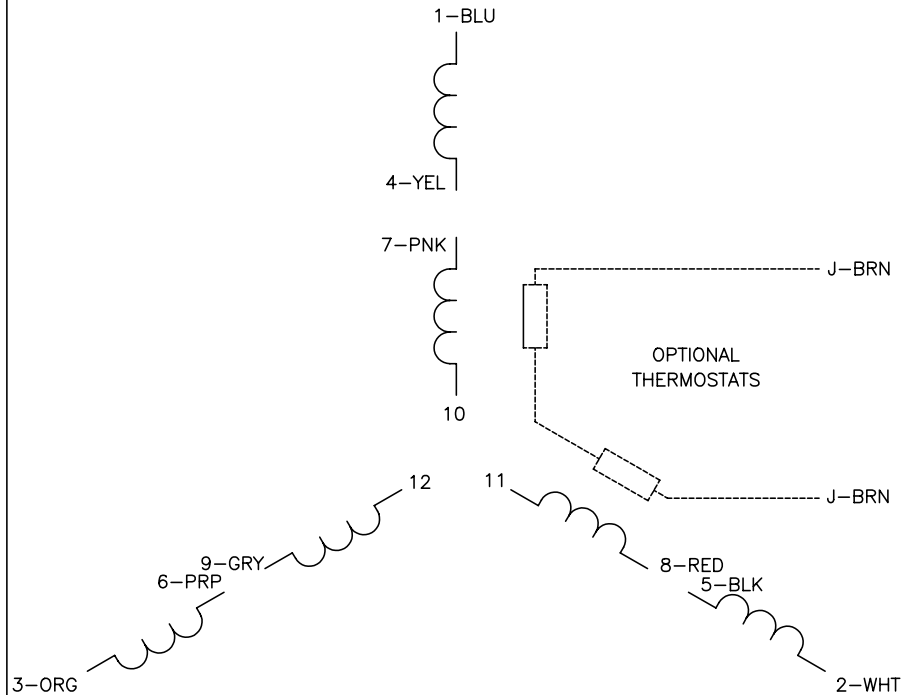

**LOW VOLTAGE**

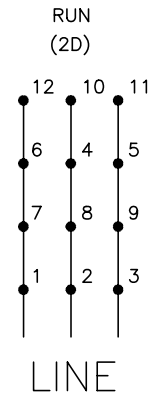
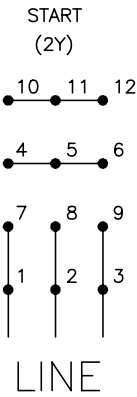

**HIGH VOLTAGE**

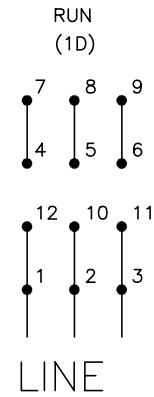
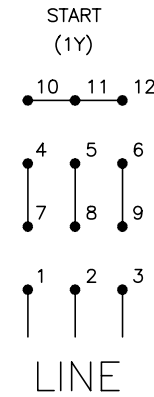

**NOTES:**

1. INTERCHANGE ANY TWO LINE LEADS TO REVERSE ROTATION.
2. OPTIONAL THERMOSTATS ARE PROVIDED WHEN SPECIFIED.
3. ACTUAL NUMBER OF INTERNAL PARALLEL CIRCUITS MAY BE A MULTIPLE OF THOSE SHOWN ABOVE.
4. LEAD COLORS ARE OPTIONAL. LEADS MUST ALWAYS BE NUMBERED AS SHOWN.

REV. DESC: REVISE TO SHOW OPTIONAL COLORS			
REV. LTR: C	BY: JLP	REVISED: 01/19/99 4:24	TDR: 0171435
CD0104		FILE: AAA00008377	MDL: -
		MTL: -	

**BALDOR ELECTRIC Co.**

3PH, DV, 12 LEADS, Y START/D RUN

CD0104