

BALDOR® • *RELIANCE*

Product Information Packet

EM2558T-4

150HP,1780RPM,3PH,60HZ,444T,1868M,OPEN

Copyright © All product information within this document is subject to Baldor Electric Company copyright © protection, unless otherwise noted.

Part Detail							
Revision:	D	Status:	PRD/A	Change #:		Proprietary:	No
Type:	AC	Prod. Type:	A44062M	Elec. Spec:	A44WG0543	CD Diagram:	
Enclosure:	DP	Mfg Plant:		Mech. Spec:		Layout:	
Frame:	444T	Mounting:	F1	Poles:	04	Created Date:	10-19-2010
Base:		Rotation:	R	Insulation:	F	Eff. Date:	05-01-2012
Leads:	3#1/0	Literature:		Elec. Diagram:		Replaced By:	

Nameplate NP2377L									
CAT.NO.	EM2558T-4	SPEC NO.	P44G1770						
HP	150	AMPS	170	VOLTS	460	DESIGN	B		
FRAME	444T	RPM	1785	HZ	60	AMB	40	SF	1.15
DRIVE END BEARING	90BC03J30X	PHASE	3	DUTY	CONT	INSUL.CLASS	F		
OPP D.E. BEARING	90BC03J30X	TYPE	P	ENCL	DP	CODE	G		
SER.NO.		POWER FACTOR	85.7	NEMA-NOM-EFFICIENCY	96.2				
		MAX CORR KVAR	30.0	GUARANTEED EFFICIENCY	95.8				
		NEMA NOM/CSA QUOTED EFF							
		MOTOR WEIGHT							

Parts List		
Part Number	Description	Quantity
SA206186	SA P44G1770	1.000 EA
RA193453	RA P44G1770	1.000 EA
613-6PU	N/P (RELEASE QTY 10,000)	1.000 EA
000692000VD	N/P (REL QTY 4000)	1.000 EA
NP2377L	SUPER-E ,SS, CSA-C US, CSA EEV	1.000 EA
004824015A	GREASE POLYREX EM	1.156 LB
032018005AK	HHCS 1/4-20X5/8 PLATED	4.000 EA
032018008AK	HHCS 1/4-20X1 PLATED	4.000 EA
032018028EK	HHCS 5/8-11X3-1/2L PLTD	4.000 EA
032018036DK	HHCS 1/2-13X4-1/2 PLTD.	3.000 EA
034000012AB	WSHR 1/4 STD. PLATED	4.000 EA
034017012AB	LCKW 1/4 STD. PLATED	4.000 EA
034600001AA	BUSH 1/4TO1/8 BLACK	1.000 EA
035000001G	GITS GRS CUP,ODE	1.000 EA
089439051A	BRKT 440 089439051WCB	1.000 EA
405851012AC	SPACE	4.000 EA
410700004A	WSHR	1.000 EA
702611001A	BAFFL 440 SUB PAINT	1.000 EA
032018005AK	HHCS 1/4-20X5/8 PLATED	4.000 EA
032018008AK	HHCS 1/4-20X1 PLATED	4.000 EA
032018028EK	HHCS 5/8-11X3-1/2L PLTD	4.000 EA
032018036DK	HHCS 1/2-13X4-1/2 PLTD.	3.000 EA
034000012AB	WSHR 1/4 STD. PLATED	4.000 EA
034017012AB	LCKW 1/4 STD. PLATED	4.000 EA

Parts List (continued)		
Part Number	Description	Quantity
034600001AA	BUSH 1/4TO1/8 BLACK	1.000 EA
035000001G	GITS GRS CUP,ODE	1.000 EA
089439051A	BRKT 440 089439051WCB	1.000 EA
405851012AC	SPACE	4.000 EA
032018008BK	HHCS 5/16-18X1L PLATED	4.000 EA
032018008DK	HHCS 1/2-13X1 PLATED	4.000 EA
033512006LB	HHTTS 1/4-20X3/4 PLTD.	1.000 EA
035000001A	ALFTG 1/8" 1610-BL	1.000 EA
035000001A	ALFTG 1/8" 1610-BL	1.000 EA
048897010DJ	BUSH - 445	1.000 EA
067053001C	GASK 440	1.000 EA
076863000C	+CBCST BLKT - 440	1.000 EA
076864000A	CB CVRCST BLKT - 440	1.000 EA
406056007A	TERBD 440	1.000 EA
415000003D	T/LUG 897-777 KPA25/G16	1.000 EA
418150003A	GREASE FITTING CAP	1.000 EA
418150003A	GREASE FITTING CAP	1.000 EA
415045002A	SLGR	1.000 EA
702611001A	BAFFL 440 SUB PAINT	1.000 EA
MG1000Y03	WILKO 689.710 GOLD PAINT SUPER E	0.250 GA
LB1346	LABEL,SUPER-E GP(4X4)	1.000 EA
033775004EA	DRSCR #6-1/4 304 S.S.	2.000 EA
034180054KA	KEY 7/8X7/8X6-3/4 L	1.000 EA
421948051	LABEL, MYLAR	1.000 EA

Parts List (continued)		
Part Number	Description	Quantity
PK5004A09	BASE 48 X 39-1/4 STACK 2 X 4 RUUNER	1.000 EA

REL. S.O.	FRAME	HP	TYPE	PHASE/ HERTZ	RPM	VOLTS
	444T	150	P	3/60	1785	460
AMPS	DUTY	AMB °C/ INSUL.	S.F.	NEMA DESIGN	CODE LETTER	ENCL.
170	CONT	40/F	1.15	B	G	PROT
E/S	ROTOR	TEST S.O.	TEST DATE	STATOR RES. @25 °C (BETWEEN LINES)		
497412	418143-040-PE	---	---	.0318		

PERFORMANCE						
LOAD	HP	AMPERES	RPM	POWER FACTOR %	EFFICIENCY %	
NO LOAD	0	59.9	1800	3.40	0	
1/4	37.5	72.2	1797	51.8	94.0	
2/4	75.0	99.1	1793	73.7	96.1	
3/4	112	133	1790	82.3	96.4	
4/4	150	170	1786	85.9	96.2	
5/4	187	210	1782	87.1	95.9	

SPEED TORQUE						
	RPM	TORQUE % FULL LOAD	TORQUE LB.-FT.	AMPERES		
LOCKED ROTOR	0	148	655	1085		
PULL UP	720	139	615	1025		
BREAKDOWN	1725	252	1110	630		
FULL LOAD	1786	100	441	170		

AMPERES SHOWN FOR 460. VOLT CONNECTION. IF OTHER VOLTAGE CONNECTIONS ARE AVAILABLE, THE AMPERES WILL VARY INVERSELY WITH THE RATED VOLTAGE

REMARKS: TYPICAL DATA
 XE MOTOR CALCULATED DATA, NEMA NOM EFF 96.2 PCT.
 GUAR MIN EFF 95.8 PCT.

BALDOR	DR. BY	R. I. STEPHENSON	A-C MOTOR	
	CK. BY	K. W. KANOUFF		PERFORMANCE DATA
	APP. BY	K. W. KANOUFF		
	DATE	04/24/96		
		ISSUE DATE	12/16/10	

Printed on 12/16/10 23:06 @ paces-motors

REL. S.O. _____ RPM 1785 S.F. 1.15 ROTOR 418143-040-PE
 FRAME 444T VOLTS 460 NEMA DESIGN B TEST S.O. TYPICAL DATA
 HP 150 AMPS 170 CODE LETTER G
 TYPE P DUTY CONT ENCLOSURE PROT STATOR RES. @ 25 °C .0318
 PHASE/HERTZ 3/60 AMB °C/INSUL 40/F E/S 497412 OHMS (BETWEEN LINES)

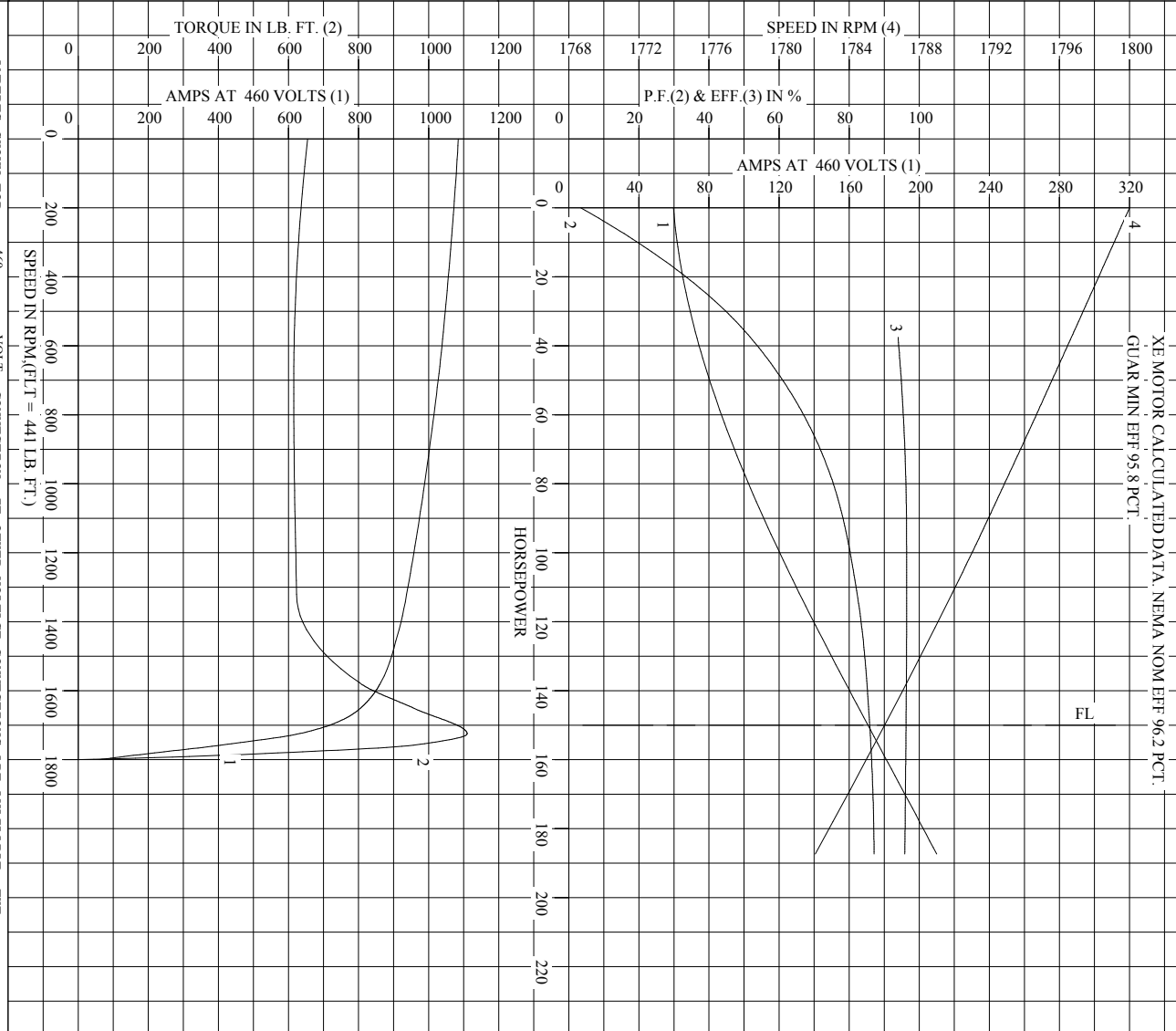

BALDOR

DR. BY R.L. STEPHENS
 CK. BY K.W. KANOUFF
 APP. BY K.W. KANOUFF
 DATE 04/24/96

A-C MOTOR PERFORMANCE CURVES A44WG0543-R003
 ISSUE DATE 12/16/10

Printed on 12/16/10 23:06 @ psecs-motorengr

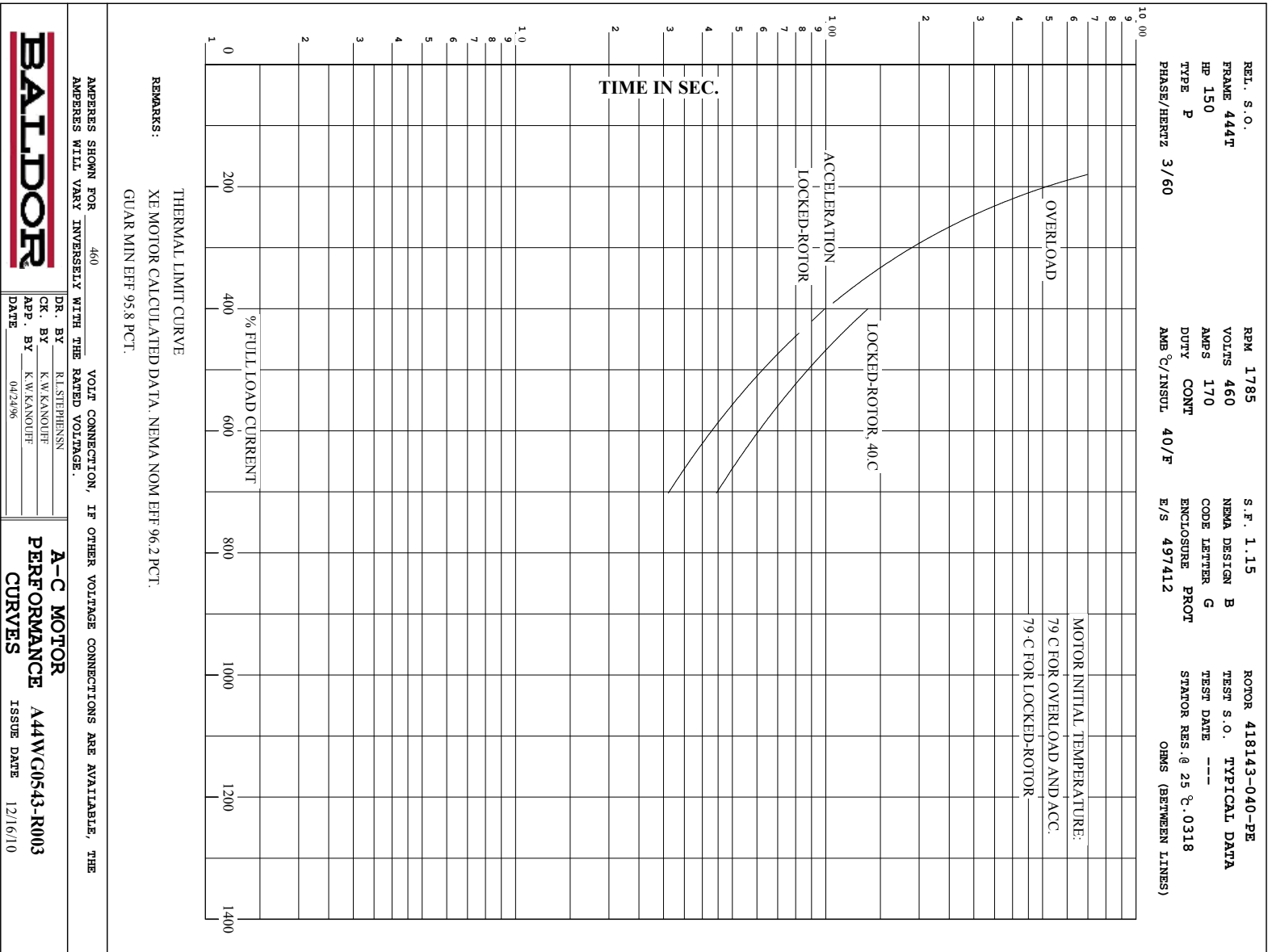

Printed on 12/16/10 23:07 @ paces-motors

611750-501

DUTY MASTER ALTERNATING CURRENT MOTORS
 SQUIREL-CAGE INDUCTION
 CAST IRON CONSTRUCTION

ENCLOSURE: PROTECTED
 MOUNTING: FOOT
 FRAMES 250T THRU 440T
 COOLING: SELF-VENTILATED

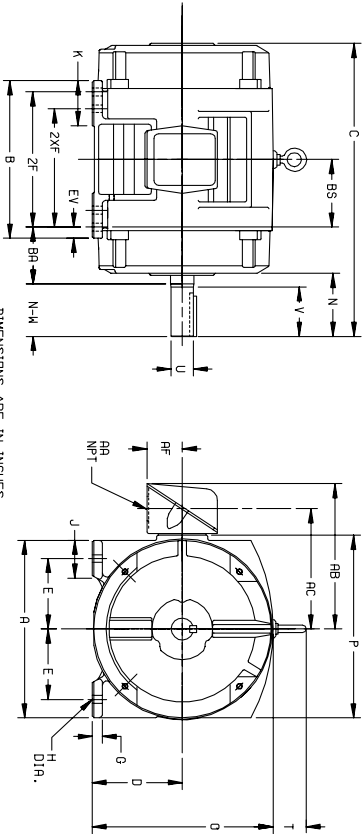

DIMENSIONS ARE IN INCHES

FRAME	A	DIG2	E	G	H	J	K	D	P	T	CAST IRON TERMINAL BOX					EV
254T-256T	12.50	6.25	5.00	.69	.56	2.25	3.50	12.61	12.69	2.44	1-1/4	10.25	8.25	2.50	4.25	6.2
284T-286T	14.00	7.00	5.50	.75	.56	2.75	3.75	14.12	14.31	2.44	1-1/2	12.06	9.62	3.19	4.75	1.00
324T-326T	15.75	8.00	6.25	.88	.69	3.12	4.00	16.10	16.42	2.44	2	14.75	11.00	3.62	5.25	1.00
364T-366T	17.00	9.00	7.00	.88	.69	3.00	3.62	18.30	19.56	2.94	3	18.00	13.81	4.12	5.88	1.00
404T-406T	19.00	10.00	8.00	1.12	.81	3.25	4.75	20.56	21.81	2.94	3	19.00	14.81	3.12	6.62	1.12
444T-446T	21.00	11.00	9.00	1.12	.81	3.25	5.25	22.91	23.62	3.25	3	21.44	16.69	5.00	7.50	1.25

FRAME	C	BS	B	2F	2XF	N	N-W/6	U(3)	V	S.O.	LGTH.	WEIGHT
SIZE	22.44	5.00	11.25	---	8.25	4.25	4.00	1.625	3.75	3.75	2.75	265
254T	22.44	5.00	11.25	---	8.25	4.25	4.00	1.625	3.75	3.75	2.75	275
256T	22.44	5.00	11.25	---	8.25	4.25	4.00	1.625	3.75	3.75	2.75	275
284T	24.94	5.50	13.00	---	9.50	4.88	4.62	1.875	4.38	5.00	3.25	340
284T	23.96	5.50	13.00	---	9.50	3.50	3.25	1.625	3.00	3.75	1.88	340
286T	23.96	5.50	13.00	---	9.50	3.25	1.625	3.00	3.75	3.00	3.25	370
286T	23.96	5.50	13.00	---	9.50	3.25	1.625	3.00	3.75	3.00	3.25	370
324T	27.56	6.00	14.00	---	10.50	5.50	5.25	2.185	5.00	5.00	3.75	480
324T	27.56	6.00	14.00	---	10.50	4.00	3.75	1.875	3.50	5.00	2.00	480
326T	27.56	6.00	14.00	---	10.50	5.25	2.185	5.00	5.00	5.00	3.75	520
326T	26.06	6.00	14.00	---	12.00	4.00	3.75	1.875	3.50	5.00	2.00	520
364T	29.70	6.12	14.25	---	11.25	6.12	5.88	2.375	5.62	6.25	4.25	735
364T	27.58	6.12	14.25	---	11.25	6.12	5.88	2.375	5.62	6.25	4.25	735
365T	27.58	6.12	14.25	---	11.25	6.12	5.88	2.375	5.62	6.25	4.25	770
365T	27.58	6.12	14.25	---	11.25	6.12	5.88	2.375	5.62	6.25	4.25	770
404T	34.00	6.88	16.00	---	12.25	7.62	7.25	2.875	7.00	7.50	5.00	1045
404T	34.00	6.88	16.00	---	12.25	7.62	7.25	2.875	7.00	7.50	5.00	1045
405T	34.00	6.88	16.00	---	12.25	7.62	7.25	2.875	7.00	7.50	5.00	1085
405T	34.00	6.88	16.00	---	12.25	7.62	7.25	2.875	7.00	7.50	5.00	1085
444T	39.56	8.25	19.00	---	14.50	8.94	8.50	3.375	8.25	8.75	6.88	1795
444T	39.56	8.25	19.00	---	14.50	8.94	8.50	3.375	8.25	8.75	6.88	1795
445T	39.56	8.25	19.00	---	14.50	8.94	8.50	3.375	8.25	8.75	6.88	1795
445T	39.56	8.25	19.00	---	14.50	8.94	8.50	3.375	8.25	8.75	6.88	1795
445T	35.81	8.25	19.00	---	16.50	5.19	4.75	2.375	4.50	6.25	3.00	1770

- (1) SPECIAL DIMENSIONS APPLYING TO THIS ORDER ON THIS LINE.
- (2) 'P' VARIES -250T - 320T +.00, -.03
- (3) 'U' VARIES +.000, -.001
- (4) ALL FRAMES HAVE EIGHT MOUNTING HOLES FOR DUAL MOUNTING.
- (5) MOTOR WEIGHTS MAY VARY BY 1% DEPENDING UPON RATING.
- (6) 'N'-W' VARIES +.00, -.25.

CONDUIT BOX LOCATED ON OPPOSITE SIDE WHEN F-2W-1, V-4-W-5-W-7, DR C-1 MOUNTING IS SPECIFIED.
 IF MOUNTING CLEARANCE DETAILS ARE REQUIRED, CONSULT FACTORY.
 MAXIMUM PERMISSIBLE SHAFT RUNOUT WHEN MEASURED AT END OF SHD. SHAFT EXTENSION IS .002 IIR UP TO AND INCLUDING 1.625 DIA. AND .003 IIR, ABOVE 1.625 TO 3 INCH DIA.

FRAME _____ TYPE _____ CERTIFIED FOR _____
 ORDER _____ ITEM _____ HP _____ RPM _____ PH _____ HZ _____ VOLTS _____
 SALES ORDER _____ APPROVED BY _____ DATE _____
 105-057119

CUSTOMER IS RESPONSIBLE FOR DETERMINING THAT BALDOR'S PRODUCT WILL PERFORM SUITABLY IN THE INTENDED APPLICATION.

REV. DESC: LOADED TO BUS	VERSION: 01	TDR: 000000546464
REV. LTR: A	REVISED: 03:18:49 06/22/2010	BY: RAGHZT
FILE: \RAG\00009\279		
MTL: -		

BALDOR
 DIM SHT-250T-440T
 SH 1 of 1

416820-036

A-C MOTOR
 CONNECTION DIAGRAM
 STANDARD 3 LEAD CONNECTED

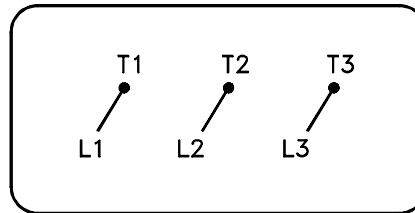

(N.P. 1575-BA)

416820-036

REV. DESC: LOADED TO BUS, C/R 335225		
REV. LTR: -	VERSION: 00	TDR: 000000538207
FILE: \MGA\00000\682	REVISED: 11:54:06 04/30/2010	
MTL: -	BY: RAGRA	

BALDOR

CONN DIAG - STANDARD 3 LEAD

SH 1 of 1

BALDOR • RELIANCE

**Integral Horsepower
AC Induction Motors
ODP, WPI Enclosures
TENV, TEAO, TEFC Enclosure
Explosion Proof**

Installation & Operating Manual

3/09

MN408

Any trademarks used in this manual are the property of their respective owners.

Table of Contents

Section 1	
General Information	
Overview	1-1
Limited Warranty	1-1
Safety Notice	1-1
Receiving	1-2
Storage	1-2
Extended Storage	1-3
Greater than 6 months	1-3
Greater than 18 months	1-3
Unpacking	1-4
Handling	1-4
Section 2	
Installation & Operation	
Overview	2-1
Location	2-1
Mounting	2-1
Frame Mounting Holes	2-2
Alignment	2-2
Doweling & Bolting	2-3
Guarding	2-3
Power Connection	2-3
Grounding	2-3
Conduit Box	2-3
AC Power	2-4
Rotation	2-4
Connection Diagrams	2-5
First Time Start Up	2-7
Initial Lubrication	2-8
Test for General Condition	2-8
Coupled Start Up	2-8
Jogging and Repeated Starts	2-8
Heating	2-8
Hazardous Locations	2-8
Selection	2-8
Protection Concepts	2-8
Repair of Motors used in Hazardous Locations	2-10
Section 3	
Maintenance & Troubleshooting	
General Inspection	3-1
Relubrication & Bearings	3-1
Type of Grease	3-1
Relubrication Intervals	3-2
Relubrication Procedure	3-4
Troubleshooting Chart	3-5
Suggested bearing and winding RTD setting guidelines for Non-Hazardous Locations ONLY	3-6

MN408

Table of Contents i

ii Table of Contents

MN408

Section 1 General Information

Overview

This manual contains general procedures that apply to Baldor Motor products. Be sure to read and understand the Safety Notice statements in this manual. For your protection, do not install, operate or attempt to perform maintenance procedures until you understand the **Warning and Caution** statements. A **Warning** statement indicates a possible unsafe condition that can cause harm to personnel.

A **Caution** statement indicates a condition that can cause damage to equipment.

Important:

This instruction manual is not intended to include a comprehensive listing of all details for all procedures required for installation, operation and maintenance. This manual describes general guidelines that apply to most of the motor products shipped by Baldor. If you have a question about a procedure or are uncertain about any detail, Do Not Proceed. Please contact your Baldor distributor for more information or clarification.

Before you install, operate or perform maintenance, become familiar with the following:

- NEMA Publication MG-2, Safety Standard for Construction and guide for Selection, Installation and Use of Electric Motors and Generators.
- IEC 34-1 Electrical and IEC72-1 Mechanical specifications
- ANSI C51.5, the National Electrical Code (NEC) and local codes and practices.

Limited Warranty

www.baldor.com/suport/warranty_standard.asp

Safety Notice:

This equipment contains high voltage! Electrical shock can cause serious or fatal injury. Only qualified personnel should attempt installation, operation and maintenance of electrical equipment.

Be sure that you are completely familiar with NEMA publication MG-2, safety standards for construction and guide for selection, installation and use of electric motors and generators, the National Electrical Code and local codes and practices. Unsafe installation or use can cause conditions that lead to serious or fatal injury. Only qualified personnel should attempt the installation, operation and maintenance of this equipment.

WARNING:

Do not touch electrical connections before you first ensure that power has been disconnected. Electrical shock can cause serious or fatal injury. Only qualified personnel should attempt the installation, operation and maintenance of this equipment.

WARNING:

Disconnect all electrical power from the motor windings and accessory devices before disassembly of the motor. Electrical shock can cause serious or fatal injury.

WARNING:

Be sure the system is properly grounded before applying power. Do not apply AC power before you ensure that all grounding instructions have been followed. Electrical shock can cause serious or fatal injury. National Electrical Code and Local codes must be carefully followed.

WARNING:

Avoid extended exposure to machinery with high noise levels. Be sure to wear ear protective devices to reduce harmful effects to your hearing.

WARNING:

Surface temperatures of motor enclosures may reach temperatures which can cause discomfort or injury to personnel accidentally coming into contact with hot surfaces. When installing, protection should be provided by the user to protect against accidental contact with hot surfaces. Failure to observe this precaution could result in bodily injury.

WARNING:

This equipment may be connected to other machinery that has rotating parts or parts that are driven by this equipment. Improper use can cause serious or fatal injury. Only qualified personnel should attempt to install operate or maintain this equipment.

WARNING:

Do not by-pass or disable protective devices or safety guards. Safety features are designed to prevent damage to personnel or equipment. These devices can only provide protection if they remain operative.

WARNING:

Avoid the use of automatic reset devices if the automatic restarting of equipment can be hazardous to personnel or equipment.

WARNING:

Be sure the load is properly coupled to the motor shaft before applying power. The shaft key must be fully captive by the load device. Improper coupling can cause harm to personnel or equipment if the load decouples from the shaft during operation.

WARNING:

UL Listed motors must only be serviced by UL Approved Authorized Baldor Service Centers if these motors are to be returned to a hazardous and/or explosive atmosphere.

WARNING:

Thermostat contacts automatically reset when the motor has slightly cooled down. To prevent injury or damage, the control circuit should be designed so that automatic starting of the motor is not possible when the thermostat resets.

MN408

General Information 1-1

Safety Notice Continued

- WARNING:** Use proper care and procedures that are safe during handling, lifting, installing, operating and maintaining operations. Improper methods may cause muscle strain or other harm.
- WARNING:** Pacemaker danger – Magnetic and electromagnetic fields in the vicinity of current carrying carrying conductors and permanent magnet motors can result result in a serious health hazard to persons with cardiac pacemakers, metal implants, and hearing aids. To avoid risk, stay way from the area surrounding a permanent magnet motor.
- WARNING:** Before performing any motor maintenance procedure, be sure that the equipment connected to the motor shaft cannot cause shaft rotation. If the load can cause shaft rotation, disconnect the load from the motor shaft before maintenance is performed. Unexpected mechanical rotation of the motor parts can cause injury or motor damage.
- WARNING:** Do not use non UL/CSA listed explosion proof motors in the presence of flammable or combustible vapors or dust. These motors are not designed for atmospheric conditions that require explosion proof operation.
- WARNING:** Motors that are to be used in flammable and/or explosive atmospheres must display the UL label on the nameplate along with CSA listed logo. Specific service conditions for these motors are defined in NFPA 70 (NEC) Article 500.
- WARNING:** Guards must be installed for rotating parts such as couplings, pulleys, external fans, and unused shaft extensions, should be permanently guarded to prevent accidental contact by personnel. Accidental contact with body parts or clothing can cause serious or fatal injury.
- Caution:** To prevent premature equipment failure or damage, only qualified maintenance personnel should perform maintenance.
- Caution:** Do not over tension belts. Excess tension may damage the motor or driven equipment.
- Caution:** Do not over-lubricate motor as this may cause premature bearing failure.
- Caution:** Do not lift the motor and its driven load by the motor lifting hardware. The motor lifting hardware is adequate for lifting only the motor. Disconnect the load (gears, pumps, compressors, or other driven equipment) from the motor shaft before lifting the motor.
- Caution:** If eye bolts are used for lifting a motor, be sure they are securely tightened. The lifting direction should not exceed a 20° angle from the shank of the eye bolt or lifting lug. Excessive lifting angles can cause damage.
- Caution:** To prevent equipment damage, be sure that the electrical service is not capable of delivering more than the maximum motor rated amps listed on the rating plate.
- Caution:** If a HI POT test (High Potential Insulation test) must be performed, follow the precautions and procedure in NEMA MG1 and MG2 standards to avoid equipment damage.
- If you have any questions or are uncertain about any statement or procedure, or if you require additional information please contact your Baldor distributor or an Authorized Baldor Service Center.
- Each Baldor Electric Motor is thoroughly tested at the factory and carefully packaged for shipment. When you receive your motor, there are several things you should do immediately.
1. Observe the condition of the shipping container and report any damage immediately to the commercial carrier that delivered your motor.
 2. Verify that the part number of the motor you received is the same as the part number listed on your purchase order.
- Receiving**
- Handling**
- Caution:** The motor should be lifted using the lifting lugs or eye bolts provided.
- Caution:** Do not lift the motor and its driven load by the motor lifting hardware. The motor lifting hardware is adequate for lifting only the motor. Disconnect the load (gears, pumps, compressors, or other driven equipment) from the motor shaft before lifting the motor.
1. Use the lugs or eye bolts provided to lift the motor. Never attempt to lift the motor and additional equipment connected to the motor by this method. The lugs or eye bolts provided are designed to lift only the motor. Never lift the motor by the motor shaft or the hood of a WP11 motor.
 2. To avoid condensation inside the motor, do not unpack until the motor has reached room temperature. (Room temperature is the temperature of the room in which it will be installed). The packing provides insulation from temperature changes during transportation.
 3. When lifting a WP11 (Weather Proof Type 2) motor, do not lift the motor by inserting lifting lugs into holes on top of the cooling hood. These lugs are to be used for hood removal only. A spreader bar should be used to lift the motor by the cast lifting lugs located on the motor frame.

Storage

4. If the motor must be mounted to a plate with the driven equipment such as pump, compressor etc., it may not be possible to lift the motor alone. For this case, the assembly should be lifted by a sling around the mounting base. The entire assembly can be lifted as an assembly for installation. Do not lift the assembly using the motor lugs or eye bolts provided. Lugs or eye bolts are designed to lift motor only. If the load is unbalanced (as with couplings or additional attachments) additional slings or other means must be used to prevent tipping. In any event, the load must be secure before lifting. If the load is unbalanced (as with couplings or additional attachments) additional slings or other means must be used to prevent tipping. In any event, the load must be secure before lifting. Storage requirements for motors and generators that will not be placed in service for at least six months from date of shipment:

Improper motor storage will result in seriously reduced reliability and failure. An electric motor that does not experience regular usage while being exposed to normally humid atmospheric conditions is likely to develop rust in the bearings or rust particles from surrounding surfaces may contaminate the bearings. The electrical insulation may absorb an excessive amount of moisture leading to the motor winding failure.

A wooden crate "shell" should be constructed to secure the motor during storage. This is similar to an export box but the sides & top must be secured to the wooden base with lag bolts (not nailed as export boxes are) to allow opening and reclosing many times without damage to the "shell".

Minimum resistance of motor winding insulation is 5 Meg ohms or the calculated minimum, which ever is greater. Minimum resistance is calculated as follows: $R_m = kV + 1$

where: (R_m is minimum resistance to ground in Meg-Ohms and

kV is rated nameplate voltage defined as Kilo-Volts.)

Example: For a 480VAC rated motor $R_m = 1.48$ meg-ohms (use 5 MΩ).

For a 4160VAC rated motor $R_m = 5.16$ meg-ohms.

Preparation for Storage

1. Some motors have a shipping brace attached to the shaft to prevent damage during transportation. The shipping brace, if provided, must be removed and stored for future use. The brace must be reinstalled to hold the shaft firmly in place against the bearing before the motor is moved.
2. Store in a clean, dry, protected warehouse where control is maintained as follows:
 - a. Shock or vibration must not exceed 2 mils maximum at 60 hertz, to prevent the bearings from brinelling. If shock or vibration exceeds this limit vibration isolation pads must be used.
 - b. Storage temperatures of 10°C (50°F) to 49°C (120°F) must be maintained.
 - c. Relative humidity must not exceed 60%.
 - d. Motor space heaters (when present) are to be connected and energized whenever there is a possibility that the storage ambient conditions will reach the dew point. Space heaters are optional.
3. Measure and record the resistance of the winding insulation (dielectric withstand) every 30 days of storage.
 - a. If motor insulation resistance decreases below the minimum resistance, contact your Baldor District office.
 - b. Place new desiccant inside the vapor bag and re-seal by taping it closed.
 - c. If a zipper-closing type bag is used instead of the heat-sealed type bag, zip the bag closed instead of taping it. Be sure to place new desiccant inside bag after each monthly inspection.
 - d. Place the shell over the motor and secure with lag bolts.
4. Where motors are mounted to machinery, the mounting must be such that the drains and breathers are fully operable and are at the lowest point of the motor. Vertical motors must be stored in the vertical position. Storage environment must be maintained as stated in step 2.

5. Motors with anti-friction bearings are to be greased at the time of going into extended storage with periodic service as follows:
 - a. Motors marked "Do Not Lubricate" on the nameplate do not need to be greased before or during storage.
 - b. Ball and roller bearing (anti-friction) motor shafts are to be rotated manually every 3 months and greased every 6 months in accordance with the Maintenance section of this manual.
 - c. Sleeve bearing (oil lube) motors are drained of oil prior to shipment. The oil reservoirs must be refilled to the indicated level with the specified lubricant. (see Maintenance). The shaft should be rotated monthly by hand at least 10 to 15 revolutions to distribute oil to bearing surfaces.
 - d. "Provisions for oil mist lubrication" – These motors are packed with grease. Storage procedures are the same as paragraph 5b.
 - e. "Oil Mist Lubricated" – These bearings are protected for temporary storage by a corrosion inhibitor. If stored for greater than 3 months or outdoor storage is anticipated, connected to the oil mist system while in storage. If this is not possible, add the amount of grease indicated under "Standard Condition" in Section 3, then rotate the shaft 15 times by hand.
 6. All breather drains are to be fully operable while in storage (drain plugs removed). The motors must be stored so that the drain is at the lowest point. All breathers and automatic "T" drains must be operable to allow breathing and draining at points other than through the bearings around the shaft. Vertical motors should be stored in a safe stable vertical position.
 7. Coat all external machined surfaces with a rust preventing material.
 8. An acceptable product for this purpose is Exxon Rust Ban # 392.
 8. Carbon brushes should be lifted and held in place in the holders, above the commutator, by the brush holder fingers. The commutator should be wrapped with a suitable material such as cardboard paper as a mechanical protection against damage.
- Non-Regreaseable Motors**
- Non-regreaseable motors with "Do Not Lubricate" on the nameplate should have the motor shaft rotated 15 times to redistribute the grease within the bearing every 3 months or more often.
- All Other Motor Types**
- Before storage, the following procedure must be performed.
1. Remove the grease drain plug, if supplied, (opposite the grease fitting) on the bottom of each bracket prior to lubricating the motor.
 2. The motor with regreaseable bearing must be greased as instructed in Section 3 of this manual.
 3. Replace the grease drain plug after greasing.
 4. The motor shaft must be rotated a minimum of 15 times after greasing.
 5. Motor Shafts are to be rotated at least 15 revolutions manually every 3 months and additional grease added every nine months (see Section 3) to each bearing.
 6. Bearings are to be greased at the time of removal from storage.
- Removal From Storage**
1. Remove all packing material.
 2. Measure and record the electrical resistance of the winding insulation resistance meter at the time of removal from storage. The insulation resistance must not be less than 50% from the initial reading recorded when the motor was placed into storage. A decrease in resistance indicates moisture in the windings and necessitates electrical or mechanical drying before the motor can be placed into service. If resistance is low, contact your Baldor District office.
 3. Regrease the bearings as instructed in Section 3 of this manual.
 4. Reinstall the original shipping brace if motor is to be moved. This will hold the shaft firmly against the bearing and prevent damage during movement.

Equipment Marking for IEC Certified Product

IEC certified products have special markings that identify the protection concept and environment requirements. An example is shown in Figure 3-1.

Figure 3-1 IEC Certified Product Markings

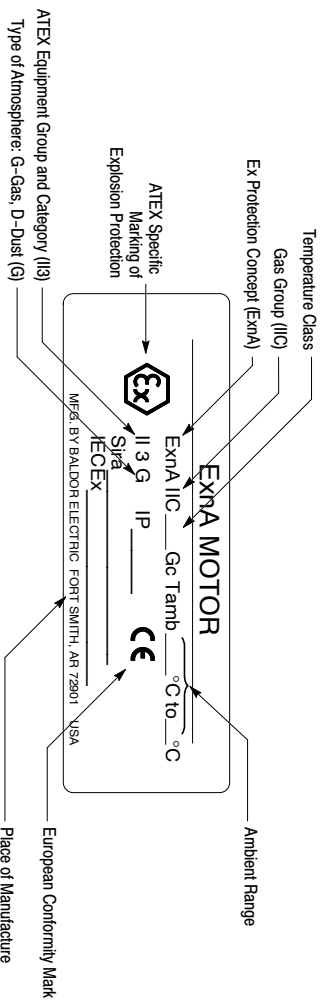

Specific Conditions of Use:

If the motor certificate number is followed by the symbol "X", this indicates that the motor has specific conditions of use which are indicated on the certificate. It is necessary to review the product certification certificate in conjunction with this instruction manual.

Operation On Frequency Converters:

If the motor is evaluated for operation with an adjustable speed drive, the type of converter (for example PWM for Pulse Width Modulated) and safe speed ranges (for example 0-120Hz) will be specified in the certification documents or on motor nameplates. It is necessary to consult the adjustable speed drive manual for proper set up.

1-6 General Information

MN408

Section 2 Installation & Operation

Overview

Installation should conform to the National Electrical Code as well as local codes and practices. When other devices are coupled to the motor shaft, be sure to install protective devices to prevent future accidents. Some protective devices include, coupling, belt guard, chain guard, shaft covers etc. These protect against accidental contact with moving parts. Machinery that is accessible to personnel should provide further protection in the form of guard rails, screening, warning signs etc.

Location

It is important that motors be installed in locations that are compatible with motor enclosure and ambient conditions. Improper selection of the motor enclosure and ambient conditions can lead to reduced operating life of the motor.

- Proper ventilation for the motor must be provided. Obstructed airflow can lead to reduction of motor life.
- Open Drip – Proof/WPI** motors are intended for use indoors where atmosphere is relatively clean, dry, well ventilated and non–corrosive.
 - Totally Enclosed and WPII** motors may be installed where dirt, moisture or dust are present and in outdoor locations.

Severe Duty, IEEE 841 and Washdown Duty enclosed motors are designed for installations with high corrosion or excessive moisture conditions. These motors should not be placed into an environment where there is the presence of flammable or combustible vapors, dust or any combustible material, unless specifically designed for this type of service.

Hazardous Locations are those where there is a risk of ignition or explosion due to the presence of combustible gases, vapors, dust, fibers, or flyings. Facilities requiring special equipment for hazardous locations are typically classified in accordance with local requirements. In the US market, guidance is provided by the National Electric Code.

Mounting

The motor should be installed in a location compatible with the motor enclosure and specific ambient. To allow adequate air flow, the following clearances must be maintained between the motor and any obstruction:

Table 2-1 Enclosure Clearance

TEFC / TENV (IC0141) Enclosures	
Fan Cover Air Intake	180 – 210T Frame 1" (25mm)
Fan Cover Air Intake	250 – 449T Frame 4" (100mm)
	IEC 112 – 132 1" (25mm)
Exhaust	IEC 160 – 280 4" (100mm)
	Envelope equal to the P Dimension on the motor dimension sheet
OPEN/Protected Enclosures	
Bracket Intake	Same as TEFC
Frame Exhaust	Exhaust out the sides envelope A minimum of the P dimension plus 2" (50mm) Exhaust out the end same as intake.

The motor must be securely installed to a rigid foundation or mounting surface to minimize vibration and maintain alignment between the motor and shaft load. Failure to provide a proper mounting surface may cause vibration, misalignment and bearing damage.

Foundation caps and sole plates are designed to act as spacers for the equipment they support. If these devices are used, be sure that they are evenly supported by the foundation or mounting surface.

When installation is complete and accurate alignment of the motor and load is accomplished, the base should be grouted to the foundation to maintain this alignment.

The standard motor base is designed for horizontal or vertical mounting. Adjustable or sliding rails are designed for horizontal mounting only. Consult your Baldor distributor or authorized Baldor Service Center for further information.

Frame Mounting Holes

Some motors have standardized frames containing 6 or 8 mounting holes. 6 hole frames are not suitable for field reversal of mounting from F-1 to F-2, etc. Figure 2-2 indicates the proper mounting holes to use.

For short frame designations 182, 213, 254, 284, 324, 364, 404, 444 (NEMA)

Figure 2-2 6 & 8 Hole Motor Frame Mounting

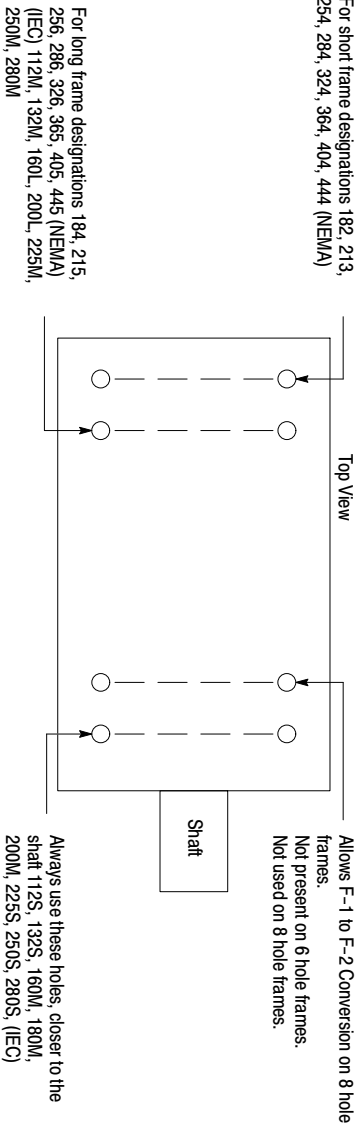

Caution: Do not lift the motor and its driven load by the motor lifting hardware. The motor lifting hardware is adequate for lifting only the motor. Disconnect the load (gears, pumps, compressors, or other driven equipment) from the motor shaft before lifting the motor.

In the case of assemblies on a common base, any lifting means provided on the motor should not be used to lift the assembly and base but, rather, the assembly should be lifted by a sling around the base or by other lifting means provided on the base. Assure lifting in the direction intended in the design of the lifting means. Likewise, precautions should be taken to prevent hazardous overloads due to deceleration, acceleration or shock forces.

Alignment

Accurate alignment of the motor with the driven equipment is extremely important. The pulley, sprocket, or gear used in the drive should be located on the shaft as close to the shaft shoulder as possible. It is recommended to heat the pulley, sprocket, or gear before installing on the motor shaft. Forcibly driving a unit on the motor shaft will damage the bearings.

1. **Direct Coupling**
For direct drive, use flexible couplings if possible. Consult the drive or equipment manufacturer for more information. Mechanical vibration and roughness during operation may indicate poor alignment. Use dial indicators to check alignment. The space between coupling hubs should be maintained as recommended by the coupling manufacturer.
2. **End-Play Adjustment**
The axial position of the motor frame with respect to its load is also extremely important. The standard motor bearings are not designed for excessive external axial thrust loads. Improper adjustment will cause failure.
3. **Pulley Ratio**
The best practice is to not exceed an 8:1 pulley ratio.
4. **Belt Drive**
Align sheaves carefully to minimize belt wear and axial bearing loads (see End-Play Adjustment). Belt tension should be sufficient to prevent belt slippage at rated speed and load. However, belt slippage may occur during starting.

Caution:

Do not over tension belts. Excess tension may damage the motor or driven equipment.

Doweling & Bolting After proper alignment is verified, dowel pins should be inserted through the motor feet into the foundation. This will maintain the correct motor position should motor removal be required.

1. Drill dowel holes in diagonally opposite motor feet in the locations provided.
2. Drill corresponding holes in the foundation.
3. Ream all holes.
4. Install proper fitting dowels.
5. Mounting bolts must be carefully tightened to prevent changes in alignment. Use a flat washer and lock washer under each nut or bolt head to hold the motor feet secure. Flanged nuts or bolts may be used as an alternative to washers.

WARNING: **Guards must be installed for rotating parts such as couplings, pulleys, external fans, and unused shaft extensions, should be permanently guarded to prevent accidental contact by personnel. Accidental contact with body parts or clothing can cause serious or fatal injury.**

Guarding

Guards must be installed for rotating parts such as couplings, pulleys, external fans, and unused shaft extensions. This is particularly important where the parts have surface irregularities such as keys, key ways or set screws. Some satisfactory methods of guarding are:

1. Covering the machine and associated rotating parts with structural or decorative parts of the driven equipment.
2. Providing covers for the rotating parts. Covers should be sufficiently rigid to maintain adequate guarding during normal service.

Power Connection Motor and control wiring, overload protection, disconnects, accessories and grounding should conform to the National Electrical Code and local codes and practices.

For ExrNA hazardous location motors, it is a specific condition of use that all terminations in a conduit box be fully insulated. Flying leads must be insulated with two full wraps of electrical grade insulating tape or heat shrink tubing.

Grounding

In the USA consult the National Electrical Code, Article 430 for information on grounding of motors and generators, and Article 250 for general information on grounding. In making the ground connection, the installer should make certain that there is a solid and permanent metallic connection between the ground point, the motor or generator terminal housing, and the motor or generator frame. In non-USA locations consult the appropriate national or local code applicable.

Motors with resilient cushion rings usually must be provided with a bonding conductor across the resilient member. Some motors are supplied with the bonding conductor on the concealed side of the cushion ring to protect the bond from damage. Motors with bonded cushion rings should usually be grounded at the time of installation in accordance with the above recommendations for making ground connections. When motors with bonded cushion rings are used in multimotor installations employing group fusing or group protection, the bonding of the cushion ring should be checked to determine that it is adequate for the rating of the branch circuit over current protective device being used.

There are applications where grounding the exterior parts of a motor or generator may result in greater hazard by increasing the possibility of a person in the area simultaneously contacting ground and some other nearby live electrical parts of other ungrounded electrical equipment. In portable equipment it is difficult to be sure that a positive ground connection is maintained as the equipment is moved, and providing a grounding conductor may lead to a false sense of security.

Select a motor starter and over current protection suitable for this motor and its application. Consult motor starter application data as well as the National Electric Code and/or other applicable local codes. For motors installed in compliance with IEC requirements, the following minimum cross sectional area of the protective conductors should be used:

Cross-sectional area of phase conductors, <i>S</i>	Minimum cross-sectional area of the corresponding protective conductor, <i>S_p</i>
<i>S</i> < 16	<i>S</i>
16 < <i>S</i> ≤ 35	16
<i>S</i> > 35	0.5 <i>S</i>

Equipotential bonding connection shall made using a conductor with a cross-sectional area of at least 4 mm².

Conduit Box For ease of making connections, an oversize conduit box is provided. Most conduit boxes can be rotated 360° in 90° increments. Auxiliary conduit boxes are provided on some motors for accessories such as space heaters, RTDs etc.

AC Power

Motors with flying lead construction must be properly terminated and insulated. Connect the motor leads as shown on the connection diagram located on the name plate or inside the cover on the conduit box. Be sure the following guidelines are met:

1. AC power is within ±10% of rated voltage with rated frequency. (See motor name plate for ratings). **OR**
 2. AC power is within ±5% of rated frequency with rated voltage. **OR**
 3. A combined variation in voltage and frequency of ±10% (sum of absolute values) of rated values, provided the frequency variation does not exceed ±5% of rated frequency.
- Performance within these voltage and frequency variations are shown in Figure 2-4.

Figure 2-3 Accessory Connections

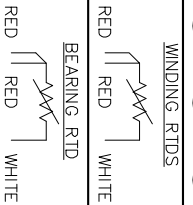
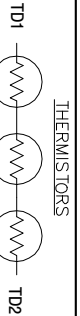

Winding RTDs are installed in windings (2) per phase. Each set of leads is labeled 1TD1, 1TD2, 1TD3, 2TD1, 2TD2, 2TD3 etc.

- * One bearing RTD is installed in Drive endplate (PUEP), leads are labeled RTDDE.
- * One bearing RTD is installed in Opposite Drive endplate (FREEP), leads are labeled RTDODE.
- * Note RTD may have 2-Red/1-White leads; or 2-White/1-Red Lead.

Rotation

All three phase motors are reversible. To reverse the direction of rotation, disconnect and lock out power and interchange any two of the three line leads for three phase motors. For single phase motors, check the connection diagram to determine if the motor is reversible and follow the connection instructions for lead numbers to be interchanged. Not all single phase motors are reversible.

Adjustable Frequency Power Inverters used to supply adjustable frequency power to induction motors produce wave forms with lower order harmonics with voltage spikes superimposed. Turn-to-turn, phase-to-phase, and ground insulation of stator windings are subject to the resulting dielectric stresses. Suitable precautions should be taken in the design of these drive systems to minimize the magnitude of these voltage spikes. Consult the drive instructions for maximum acceptable motor lead lengths, and proper grounding.

Note: Main power leads for CE Marked Motors may be marked U, V, W – for standard configurations. please consult connection diagrams.

Connection Diagrams
AC Motor Connection Diagram

IEC VERSUS NEMA LEAD MARKING
EXAMPLE COMPARISONS OF IEC AND NEMA LEADING MARKINGS FOR COMMON CONNECTION TYPES ARE SHOWN BELOW.

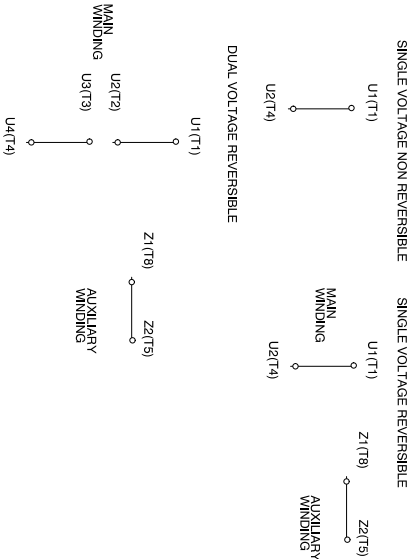

AC Motor Connection Diagram

THREE PHASE
FOR SINGLE WINDING 3 PHASE MOTORS, LEAD MARKINGS CAN BE DIRECTLY TRANSLATED FOR SINGLE LEAD MOTORS AS FOLLOWS:

- U1=I1 U2=I2 U3=I3 U4=I4 U5=I5 U6=I6
- V1=I7 V2=I8 V3=I9 V4=I10 V5=I11 V6=I12
- W1=I13 W2=I14 W3=I15 W4=I16 W5=I17 W6=I18
- W7=I19 W8=I20 W9=I21 W10=I22 W11=I23 W12=I24

EXAMPLES OF COMMON CONNECTIONS ARE GIVEN BELOW.

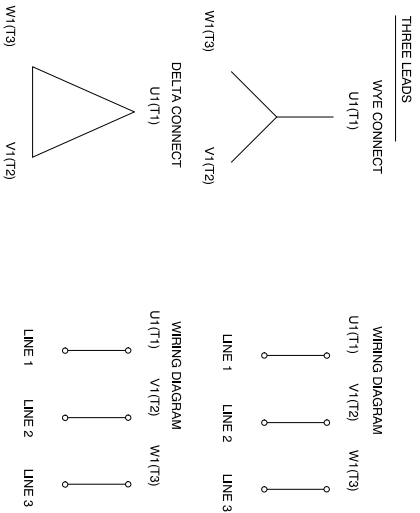

AC Motor Connection Diagram

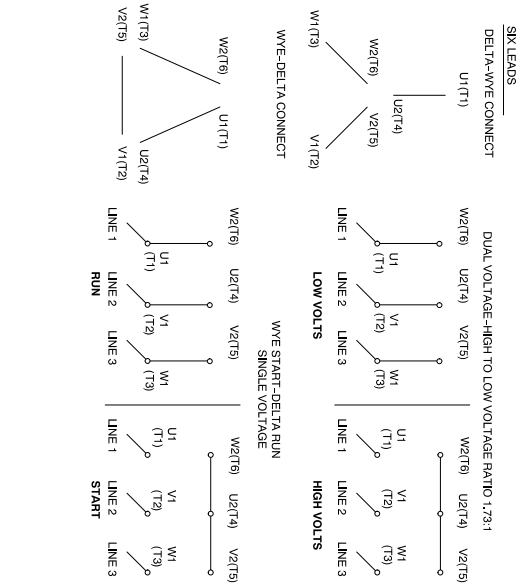

AC Motor Connection Diagram

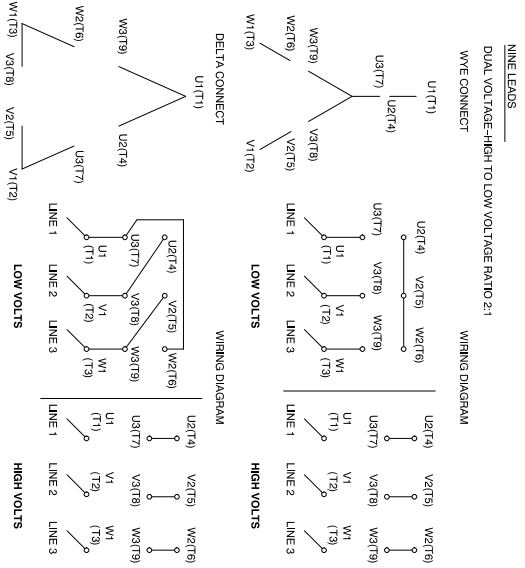

MN408

Installation & Operation 2-5

Connection Diagrams Continued
AC Motor Connection Diagram

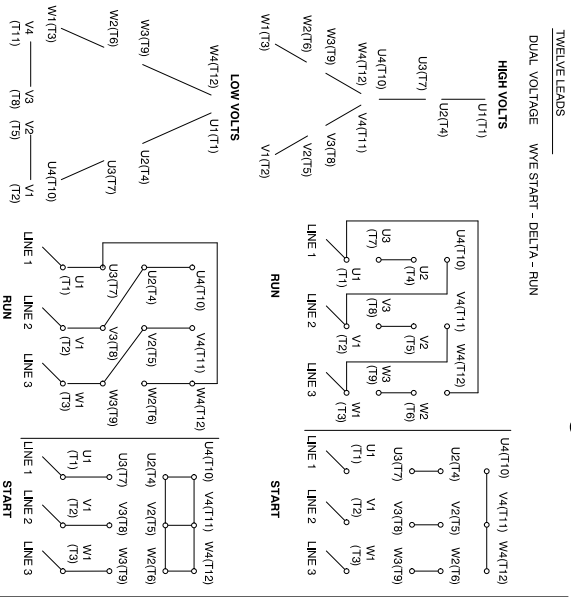

AC Motor Connection Diagram

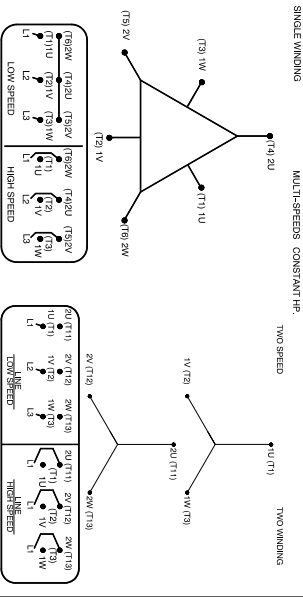

DC Motor Connection Diagram

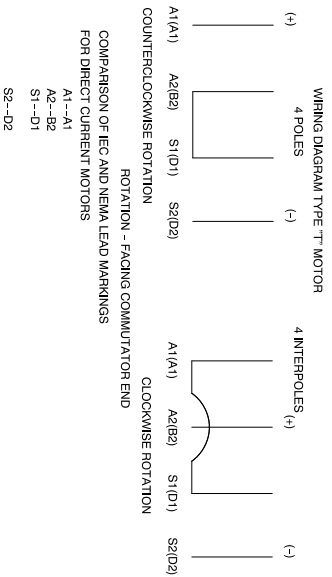

2-6 Installation & Operation

AC Motor Connection Diagram

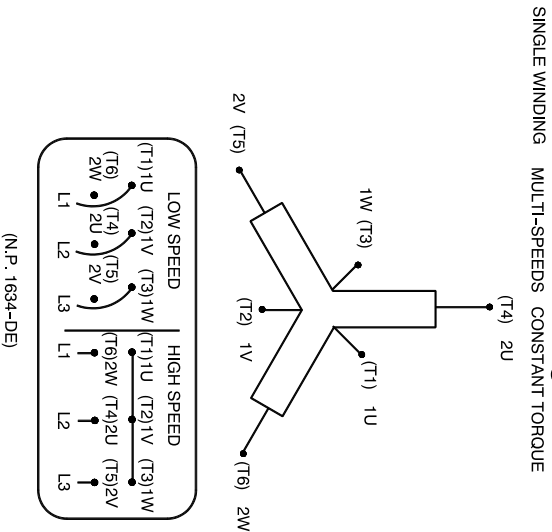

MOTOR WINDING THERMOSTATS		°C
CONTACTS	FIGURE NUMBER	
CONTACT RATING		
VOLTS	CONTINUOUS AMPERES	INRUSH AMPERES
110 - 120	3.0	30
220 - 240	1.5	15
440 - 480	0.75	7.5
550 - 600	0.60	6.0

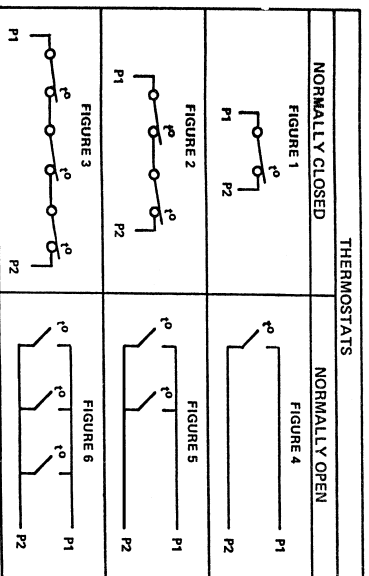

MN408

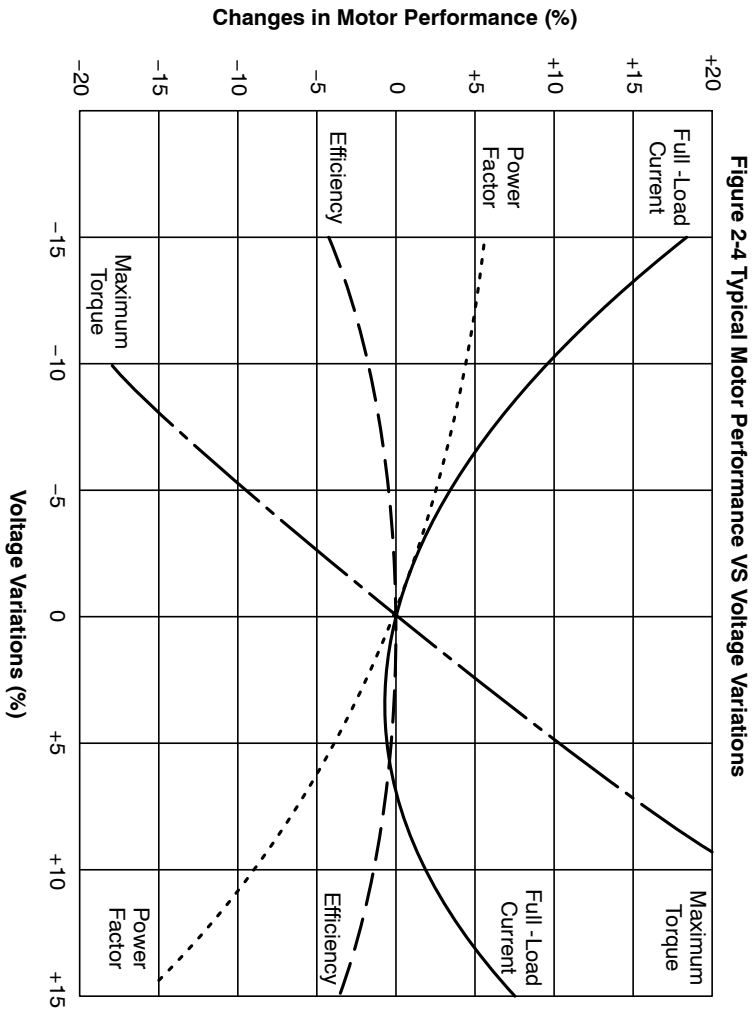

Figure 2-4 Typical Motor Performance VS Voltage Variations

Initial Lubrication Baldor•Reliance motors are shipped from the factory with the bearings properly packed with grease and ready to operate. Where the unit has been subjected to extended storage (6 months or more) the bearings should be relubricated (greasable type) prior to starting. When motors are equipped for oil mist lubrication refer to the instruction manual for installation, operation, and maintenance of oil mist lubrication systems.

First Time Start Up Be sure that all power to motor and accessories is off. Be sure the motor shaft is disconnected from the load and will not cause mechanical rotation of the motor shaft.

1. Make sure that the mechanical installation is secure. All bolts and nuts are tightened etc.
2. If motor has been in storage or idle for some time, check winding insulation integrity.
3. Inspect all electrical connections for proper termination, clearance, mechanical strength and electrical continuity.
4. Be sure all shipping materials and braces (if used) are removed from motor shaft.
5. Manually rotate the motor shaft to ensure that it rotates freely.
6. Replace all panels and covers that were removed during installation.
7. Momentarily apply power and check the direction of rotation of the motor shaft.
8. If motor rotation is wrong, be sure power is off and change the motor lead connections. Verify rotation direction before you continue.
9. Start the motor and ensure operation is smooth without excessive vibration or noise. If so, run the motor for 1 hour with no load connected.
10. After 1 hour of operation, disconnect power and connect the load to the motor shaft. Verify all coupling guards and protective devices are installed. Ensure motor is properly ventilated.
11. If motor is totally enclosed fan-cooled or non-ventilated it is recommended that condensation drain plugs, if present, be removed. These are located in the lower portion of the end-shields. Totally enclosed fan-cooled "XT" motors are normally equipped with automatic drains which may be left in place as received.

Coupled Start Up This procedure assumes a coupled start up. Also, that the first time start up procedure was successful.

1. Check the coupling and ensure that all guards and protective devices are installed.
2. Check that the coupling is properly aligned and not binding.
3. The first coupled start up should be with no load. Apply power and verify that the load is not transmitting excessive vibration back to the motor through the coupling or the foundation. Vibration should be at an acceptable level.
4. Run for approximately 1 hour with the driven equipment in an unloaded condition.

The equipment can now be loaded and operated within specified limits. Do not exceed the name plate ratings for amperes for steady continuous loads.

Jogging and Repeated Starts Repeated starts and/or jogs of induction motors generally reduce the life of the motor winding insulation. A much greater amount of heat is produced by each acceleration or jog than by the same motor under full load. If it is necessary to repeatedly start or jog the motor, it is advisable to check the application with your local Baldor distributor or Baldor Service Center.

Heating - Duty rating and maximum ambient temperature are stated on the motor name plate. Do not exceed these values. If there is any question regarding safe operation, contact your local Baldor distributor or Baldor Service Center.

Hazardous Locations

Hazardous locations are those where there is a risk of ignition or explosion due to the presence of combustible gases, vapors, dust, fibers or flyings.

Selection Facilities requiring special equipment for hazardous locations are typically classified in accordance with local requirements. In the US market, guidance is provided by the National Electric Code. In international hazardous location areas, guidance for gas / vapor / mist classification is given in IEC60079-14, or for dust in IEC61241-14. This classification process lets the installer know what equipment is suitable for installation in that environment, and identifies what the maximum safe temperature or temperature class is required. It is the customer or users responsibility to determine the area classification and select proper equipment.

Areas are classified with respect to risk and exposure to the hazard. In the US market, areas are typically classified as follows Class, Division, Group and Temperature Class. In some newer installations in the US and in most international markets, areas are classified in Zones.

Protection Concepts

Class I Division 1 / Zone 1 [Equipment Group I (mining) or II (surface), Equipment Protection Level (EPL) Gb, Mb]

Baldor offers a range of motors suitable for installation in a Division 1 or Zone 1 environment. These motors are known as explosion proof or flameproof. (Insert flameproof motor cut away drawing)
Motors that are explosion proof or flameproof use specially machined flameproof joints between the end bell or bracket and the frame, as well as along the rotating shaft and at connection box covers and entries. The fit of these flameproof joints are designed to contain the combustion or quench the flame of an explosive gas atmosphere prior to it exiting the motor. These flameproof joints have lengths and widths selected and tested based on the gas group present in the atmosphere. Baldor•Reliance motors are typically designed to meet Class I (Division 1) Group C and D (explosion proof) or Ex d IIB (flameproof).

An application note regarding equipment applied in accordance with the US National Electric Code (NFPA 70-2008) – according to Article 500.8(C) Marking, sub clause (2) in the fine print note, it is noted that Equipment not marked to indicate a division is suitable for both Division 1 and Division 2 locations. These motors are not gas tight. To the contrary, this protection concept assumes that due to the normal heating and cooling cycle of motor operation that any gas present will be drawn into the motor. Since flameproof or explosion proof motors are designed to contain the combustion and extinguish any flame transmission, for this protection concept, only external surface temperatures are of concern. Thermal limiting devices such as thermostats, thermistors or RTDs may be provided on these motors to limit the external surface temperature during overload conditions.

If thermostats are provided as a condition of certification, it is the installer's responsibility to make sure that these devices are properly connected to a suitable switching device. The ATEX directive requires that motor shutdown on thermal trip be accomplished without an intermediate software command. Flameproof motors, internationally referred to as Ex d use a protection concept similar to that used in Class I Division 1 motors, with minor differences in the flameproof joints and cable entry designs. Flameproof and explosion proof motors are both type tested. Representative motors are connected to a reference gas and ignited in laboratory conditions to verify that the flame is not transmitted outside the motor enclosure and to determine the maximum internal pressure encountered.

Explosion proof and Flame proof motors shipped without a conduit box require use of a certified box of suitable dimensions and that is appropriate for the classification.

Class I Division 2 / Zone 2 Ex nA, [Equipment Protection Level (EPL) Gc]

This protection concept relies on having no sources of ignition present such as arcing parts or hot surfaces. For this protection concept, internal temperatures as well as external temperatures are considered. In many cases, the internal temperatures are higher than the external temperatures and therefore become the limiting factor in determination of temperature code designation. In these applications, it is very important to use a motor that has been evaluated thermally for use with an inverter or converter, if variable speed operation is desired. Thermostats used for Class I Division 2 and Ex nA motors are used to protect the motor only. For motors using flying lead construction, it is important to use connection lugs and insulate with heat shrink tubing or a double wrap of insulation grade electrical tape to avoid the risk of spark or ignition.

Class II Division 1 / Zone 21 [Equipment Group III, Equipment Protection Level (EPL) Db]

This area classification is one where the risk of ignitable concentrations of dust is present at all or some of the time. The protection concepts used for Class II Division 1 is similar to flameproof, except with additional dust exclusion paths designed for the rotating shaft. In the international designations, this concept is referred to as dust ignition proof or Ex tD. External surface temperature remains the limiting factor. Thermal limiting devices such as thermostats, thermistors or RTDs may be provided on these motors to limit the external surface temperature during overload conditions. If thermostats are provided as a condition of certification, it is the installer's responsibility to make sure that these devices are properly connected to a suitable switching device.

Note: In the North American area classification system, Class III exists for fibers and flyings.

In the IEC designation, both dusts and flyings are absorbed into Group III.

Class II Division 2 / Zone 22 [Equipment Group III, Equipment Protection Level (EPL) Dc]

This area classification is one where the risk of exposure to ignitable concentrations of dust are not likely to occur under normal operating conditions and relies heavily on the housekeeping practices within the installation.

Sine Wave Power Operation for Division 1 or 2 and Zone 1 or 2 and Zone 21 or 22 Hazardous Location.

These motors are designed to operate at or below the maximum surface temperature (or T-Code) stated on the nameplate. Failure to operate the motor properly can cause this maximum surface temperature to be exceeded. If applied in a Division 1 or 2 / Zone 1 or 2 and Zone 21 or 22 environment, this excessive temperature may cause ignition of hazardous materials. Operating the motor at any of the following conditions can cause the marked surface temperature to be exceeded.

1. Motor load exceeding service factor nameplate value
2. Ambient temperatures above nameplate value
3. Voltages above or below nameplate value
4. Unbalanced voltages
5. Loss of proper ventilation
6. Altitude above 3300 feet / 1000 meters
7. Severe duty cycles of repeated starts
8. Motor stall
9. Motor reversing
10. Single phase operation of polyphase equipment
11. Variable frequency operation

Variable Frequency Power Operation for Division 1 or 2 and Zone 1 or 2 and Zone 21 or 22

Hazardous Location (motors with maximum surface temperature listed on the nameplate).

Only motors with nameplates marked for use on inverter (variable frequency) power, and labeled for specific hazardous areas may be used in those hazardous areas on inverter power. The motor is designed to operate at or below the maximum surface temperature (or T-Code) stated on the nameplate. Failure to operate the motor properly can cause this maximum surface temperature to be exceeded.

If applied in a Division 1 or 2 / Zone 1 or 2 and Zone 21 or 22 environment, this excessive temperature may cause ignition of hazardous materials. Operating the motor at any of the following conditions can cause the marked surface temperature to be exceeded.

1. Motor load exceeding service factor nameplate value
2. Ambient temperature above nameplate value
3. Voltage (at each operating frequency) above or below rated nameplate value
4. Unbalanced voltages
5. Loss of proper ventilation
6. Operation outside of the nameplate speed / frequency range
7. Altitudes above 3300 feet / 1000 meters
8. Single phase operation of polyphase equipment
9. Unstable current wave forms
10. Lower than name plate minimum carrier frequency

Thermal Limiting

Thermal limiting devices are temperature sensing control components installed inside the motor to limit the internal temperature of the motor frame by interrupting the circuit of the holding coil of the magnetic switch or contactor. They are required for most Division 1 and Zone 1 applications. For Division 2 or Zone 2 applications, motors should be selected that preclude running temperatures from exceeding the ignition temperatures for the designated hazardous material. In Division 2 or Zone 2 classified locations, thermal limiting devices should only be used for winding protection and not considered for limiting all internal motor temperatures to specific ignition temperatures.

Equipotential Bonding and Shaft Current Reduction

Larger motors (ie WP construction) may require proper bonding between motor enclosures and covers to avoid the risk of stray currents during start up. Fastening methods and bonding straps must not be modified. Bearing currents can exist in some motors for both line-fed and inverter-fed applications. Larger line-fed motors may require at least one insulated bearing to prevent a flow of current through the bearings. Do not defeat such insulation whether the motor is line-fed or inverter-fed applications. Inverter-fed motors may require additional bearing insulation or even a shaft brush. Do not defeat such features. When the motor and the coupled load are not on a common conductive baseplate, it may also be necessary to electrically bond together the stationary parts of the motor and the coupled equipment.

Repair of Motors used in Hazardous Locations

Repair of hazardous certified motors requires additional information, skill, and care. It is the customer's responsibility to select service shops with proper qualifications to repair hazardous location motors.

Contact the manufacturer for additional repair details. Use only original manufacturer's parts.

Repair of Explosion Proof or Flame Proof Motors Class I Division 1 and Zone 1

In the North American market, recertification programs are offered by Underwriters Laboratories and Canadian Standards Association which allow authorized service shops to mark the rebuilt motors as certified. In the international markets using IEC based requirements, repair should be undertaken only after consulting IEC60079-19 Explosive Atmospheres-Part 19 Equipment repair, overhaul and reclamation. If use of a certified repair facility is desired, consult the IECEx Repair Scheme at http://www.iecex.com/service_facilities.htm

Explosion proof and flameproof motors achieve their safety based on the mechanical construction – flameproof joints and bearing clearance, and the electrical design including any thermal limiting devices. If it is necessary to repair a flameproof or explosion proof motor, it is critical that the mechanical flameproof joints be maintained. Consult Baldor Electric Company for flameproof joint construction details. Use only Baldor•Reliance supplied parts. Baldor does not recommend reclamation of parts. Since this protection method also relies on temperature being maintained, make sure that any rewinding uses the original electrical designs, including any thermal protection that may be present.

Repair of Dust Ignition Proof Motors – Class II Division 1 and 2, Zone 21 and 22.

For Dust Ignition Proof, proper sealing is required. Do not modify the motor construction to add any additional opening, and ensure that proper sealing is maintained in the connection box and at the shaft seal. Since this protection method also relies on temperature being maintained, make sure that any rewinding uses the original electrical designs, including any thermal protection that may be present

Repair of Class I Division 2 and Zone 2 motors

For Division 2 and Zone 2, the internal and external temperatures are of concern. Since this protection method also relies on temperature being maintained, make sure that any rewinding uses the original electrical designs, including any thermal protection that may be present. Use only Baldor replacement thermostats, if provided.

Section 3 Maintenance & Troubleshooting

WARNING: UL and EX Listed motors must only be serviced by UL or EX Approved Authorized Baldor Service Centers if these motors are to be returned to a hazardous and/or explosive atmosphere.

General Inspection Inspect the motor at regular intervals, approximately every 500 hours of operation or every 3 months, whichever occurs first. Keep the motor clean and the ventilation openings clear. The following steps should be performed at each inspection:

WARNING: Do not touch electrical connections before you first ensure that power has been disconnected. Electrical shock can cause serious or fatal injury. Only qualified personnel should attempt the installation, operation and maintenance of this equipment.

1. Check that the motor is clean. Check that the interior and exterior of the motor is free of dirt, oil, grease, water, etc. Oily vapor, paper pulp, textile lint, etc. can accumulate and block motor ventilation. If the motor is not properly ventilated, overheating can occur and cause early motor failure.
2. Perform a dielectric with stand test periodically to ensure that the integrity of the winding insulation has been maintained. Record the readings. Immediately investigate any significant decrease in insulation resistance.
3. Check all electrical connectors to be sure that they are tight.

Relubrication & Bearings Bearing grease will lose its lubricating ability over time, not suddenly. The lubricating ability of a grease (over time) depends primarily on the type of grease, the size of the bearing, the speed at which the bearing operates and the severity of the operating conditions. Good results can be obtained if the following recommendations are used in your maintenance program.

Type of Grease A high grade ball or roller bearing grease should be used. Recommended grease for standard service conditions is **Polyrex EM (Exxon Mobil)**. Do not mix greases unless compatibility has been checked and verified.

Ball Bearing Motors

Operating Temperature -25°C (-15°F) to 50°C (120°F)	POLYREX EM (Standard on Baldor motors)
EXXON	UNIREX N2
EXXON	BEACON 325
CHEVRON OIL	SRI NO. 2 (Compatible with Polyrex EM)
CHEVRON OIL	BLACK PEARL
TEXACO, INC.	PREMIUM RB
TEXACO, INC.	POLYSTAR
AMOCO	RYKON # 2
PENNZOIL	PENNZLUBE EM-2
DARMEK	DARMEK 707
DARMEK	DARMEK 711
PETRO-CANADA	PEERLESS LLG
SHELL OIL	DOLLUM BRB

Minimum Starting Temperature -60°C (-76°F)	
SHELL OIL CO.	AEROSHELL 7 (Standard on Baldor motors)
MOBIL	MOBIL 28
MOBIL	MOBILITH SHC 100 (Low Temperature - Arctic Duty)

Roller Bearing Motors

Operating Temperature -25°C (-15°F) to 50°C (120°F)	
TEXACO, INC.	PREMIUM RB
MOBIL	MOBILITH SHC 220 (Standard on Baldor motors)
CHEVRON OIL	BLACK PEARL

Relubrication Intervals Recommended relubrication intervals are shown in Table 3-2. It is important to realize that the recommended intervals of Table 3-2 are based on average use.

Refer to additional information contained in Tables 3-3, 3-4 and 3-5.

Table 3-2 Relubrication Intervals *

NEMA / (IEC) Frame Size	Rated Speed - RPM					
	10000	6000	3600	1800	1200	900
Up to 210 Incl. (132)	**	2700 Hrs.	5500 Hrs.	12000 Hrs.	18000 Hrs.	22000 Hrs.
Over 210 to 280 Incl. (180)		**	3600 Hrs.	9500 Hrs.	15000 Hrs.	18000 Hrs.
Over 280 to 360 Incl. (225)		**	* 2200 Hrs.	7400 Hrs.	12000 Hrs.	15000 Hrs.
Over 360 to 449 Incl. (315)		**	*2200 Hrs.	3500 Hrs.	7400 Hrs.	10500 Hrs.

* Relubrication intervals are for ball bearings.

For vertically mounted motors and roller bearings, divide the relubrication interval by 2.

** For motors operating at speeds greater than 3600 RPM, contact Baldor for relubrication recommendations.

Table 3-3 Service Conditions

Severity of Service	Hours per day of Operation	Ambient Temperature Maximum	Atmospheric Contamination
Standard	8	40° C	Clean, Little Corrosion
Severe	16 Plus	50° C	Moderate dirt, Corrosion
Extreme	16 Plus	>50° C* or Class H Insulation	Severe dirt, Abrasive dust, Corrosion, Heavy Shock or Vibration
Low Temperature		<-29° C **	

* Special high temperature grease is recommended (Dow Corning DC44). Note that Dow Corning DC44 grease does not mix with other grease types. Thoroughly clean bearing & cavity before adding grease.

** Special low temperature grease is recommended (Aeroshell 7).

Table 3-4 Relubrication Interval Multiplier

Severity of Service	Multiplier
Standard	1.0
Severe	0.5
Extreme	0.1
Low Temperature	1.0

Some motor designs use different bearings on each motor end. This is normally indicated on the motor nameplate. In this case, the larger bearing is installed on the motor Drive endplate. For best relubrication results, only use the appropriate amount of grease for each bearing size (not the same for both).

Table 3-5 Bearings Sizes and Types

Frame Size NEMA (IEC)	Bearing	Bearing Description (These are the "Large" bearings (Shaft End) in each frame size)		
		Weight of Grease to add *	Volume of grease to be added	
		oz (Grams)	in ³	teaspoon
56 to 140 (90)	6203	0.08 (2.4)	0.15	0.5
140 (90)	6205	0.15 (3.9)	0.2	0.8
180 (100-112)	6206	0.19 (5.0)	0.3	1.0
210 (132)	6307	0.30 (8.4)	0.6	2.0
250 (160)	6309	0.47 (12.5)	0.7	2.5
280 (180)	6311	0.61 (17)	1.2	3.9
320 (200)	6312	0.76 (20.1)	1.2	4.0
360 (225)	6313	0.81 (23)	1.5	5.2
400 (250)	6316	1.25 (33)	2.0	6.6
440 (280)	6319	2.12 (60)	4.1	13.4
5000 to 5800 (315-450)	6328	4.70 (130)	9.2	30.0
5000 to 5800 (315-450)	NU328	4.70 (130)	9.2	30.0
360 to 449 (225-280)	NU319	2.12 (60)	4.1	13.4
AC Induction Servo				
76 Frame 180 (112)	6207	0.22 (6.1)	0.44	1.4
77 Frame 210 (132)	6210	0.32 (9.0)	0.64	2.1
80 Frame 250(160)	6213	0.49 (14.0)	0.99	3.3

* Weight in grams = .005 DB of grease to be added
 Note: Not all bearing sizes are listed.
 For intermediate bearing sizes, use the grease volume for the next larger size bearing.

Caution: To avoid damage to motor bearings, grease must be kept free of dirt. For an extremely dirty environment, contact your Baldor distributor or an authorized Baldor Service Center for additional information.

Relubrication Procedure Be sure that the grease you are adding to the motor is compatible with the grease already in the motor. Consult your Baldor distributor or an authorized service center if a grease other than the recommended type is to be used.

Caution: Do not over-lubricate motor as this may cause premature bearing failure.

With Grease Outlet Plug

1. With the motor stopped, clean all grease fittings with a clean cloth.
2. Remove grease outlet plug.

Caution: Over-lubricating can cause excessive bearing temperatures, premature lubrication breakdown and bearing failure.

3. Add the recommended amount of grease.
4. Operate the motor for 15 minutes with grease plug removed. This allows excess grease to purge.
5. Re-install grease outlet plug.

Without Grease Provisions

Note: Only a Baldor authorized and UL or CSA certified service center can disassemble a UL/CSA listed explosion proof motor to maintain it's UL/CSA listing.

1. Disassemble the motor.
2. Add recommended amount of grease to bearing and bearing cavity. (Bearing should be about 1/3 full of grease and outboard bearing cavity should be about 1/2 full of grease.)
3. Assemble the motor.

Sample Relubrication Determination

Assume - NEMA 286T (IEC 180), 1750 RPM motor driving an exhaust fan in an ambient temperature of 43° C and the atmosphere is moderately corrosive.

1. Table 3-2 list 9500 hours for standard conditions.
 2. Table 3-3 classifies severity of service as "Severe".
 3. Table 3-5 shows that 1.2 in³ or 3.9 teaspoon of grease is to be added.
- Note: Smaller bearings in size category may require reduced amounts of grease.

Table 3-6 Troubleshooting Chart

Symptom	Possible Causes	Possible Solutions
Motor will not start	Usually caused by line trouble, such as, single phasing at the starter.	Check source of power. Check overloads, fuses, controls, etc.
Excessive humming	High Voltage.	Check input line connections.
	Eccentric air gap.	Have motor serviced at local Baldor service center.
Motor Over Heating	Overload. Compare actual amps (measured) with nameplate rating.	Locate and remove source of excessive friction in motor or load.
	Single Phasing.	Reduce load or replace with motor of greater capacity. Check current at all phases (should be approximately equal) to isolate and correct the problem.
	Improper ventilation.	Check external cooling fan to be sure air is moving properly across cooling fins.
	Unbalanced voltage.	Excessive dirt build-up on motor. Clean motor.
	Rotor rubbing on stator.	Check voltage at all phases (should be approximately equal) to isolate and correct the problem.
	Over voltage or under voltage.	Check air gap clearance and bearings.
	Open stator winding.	Tighten "Thru Bolts".
	Grounded winding.	Check input voltage at each phase to motor.
	Improper connections.	Check stator resistance at all three phases for balance.
		Perform dielectric test and repair as required.
Bearing Over Heating	Misalignment.	Inspect all electrical connections for proper termination, clearance, mechanical strength and electrical continuity. Refer to motor lead connection diagram.
	Excessive belt tension.	Check and align motor and driven equipment.
	Excessive end thrust.	Reduce belt tension to proper point for load.
	Excessive grease in bearing.	Reduce the end thrust from driven machine.
	Insufficient grease in bearing.	Remove grease until cavity is approximately 3/4 filled.
	Dirt in bearing.	Add grease until cavity is approximately 3/4 filled.
Vibration	Misalignment.	Clean bearing cavity and bearing. Repack with correct grease until cavity is approximately 3/4 filled.
	Rubbing between rotating parts and stationary parts.	Check and align motor and driven equipment.
	Rotor out of balance.	Isolate and eliminate cause of rubbing.
	Resonance.	Have rotor balance checked are repaired at your Baldor Service Center.
Noise	Foreign material in air gap or ventilation openings.	Tune system or contact your Baldor Service Center for assistance.
Growling or whining	Bad bearing.	Remove rotor and foreign material. Reinstall rotor. Check insulation integrity. Clean ventilation openings.
		Replace bearing. Clean all grease from cavity and new bearing. Repack with correct grease until cavity is approximately 3/4 filled.

MN408

Maintenance & Troubleshooting 3-5

Suggested bearing and winding RTD setting guidelines for Non-Hazardous Locations ONLY

Most large frame AC Baldor motors with a 1.15 service factor are designed to operate below a Class B (80°C) temperature rise at rated load and are built with a Class H winding insulation system. Based on this low temperature rise, RTD (Resistance Temperature Detectors) settings for Class B rise should be used as a starting point. Some motors with 1.0 service factor have Class F temperature rise.

The following tables show the suggested alarm and trip settings for RTDs. Proper bearing and winding RTD alarm and trip settings should be selected based on these tables unless otherwise specified for specific applications.

If the driven load is found to operate well below the initial temperature settings under normal conditions, the alarm and trip settings may be reduced so that an abnormal machine load will be identified.

The temperature limits are based on the installation of the winding RTDs imbedded in the winding as specified by NEMA. Bearing RTDs should be installed so they are in contact with the outer race on ball or roller bearings or in direct contact with the sleeve bearing shell.

Winding RTDs - Temperature Limit In °C (40°C Maximum Ambient)

Motor Load	Class B Temp Rise ≤ 80°C (Typical Design)		Class F Temp Rise ≤ 105°C		Class H Temp Rise ≤ 125°C	
	Alarm	Trip	Alarm	Trip	Alarm	Trip
≤ Rated Load	130	140	155	165	175	185
Rated Load to 1.15 S.F.	140	150	160	165	180	185

Note: • Winding RTDs are factory production installed, not from Mod-Express.
• When Class H temperatures are used, consider bearing temperatures and relubrication requirements.

Bearing RTDs - Temperature Limit In °C (40°C Maximum Ambient)

Bearing Type Oil or Grease	Anti-Friction		Sleeve	
	Alarm	Trip	Alarm	Trip
Standard*	95	100	85	95
High Temperature**	110	115	105	110

Note: * Bearing temperature limits are for standard design motors operating at Class B temperature rise.

** High temperature lubricants include some special synthetic oils and greases.

Greases that may be substituted that are compatible with Polyrex EM (but considered as "standard" lubricants) include the following:

- Texaco Polystar
- Mobilith SHC-100
- Darnex 707
- Rykon Premium #2
- Pennzoil Pennzube EM-2
- Petro-Canada Peerless LLG
- Chevron SRI #2
- Chevron Black Pearl

See the motor nameplate for replacement grease or oil recommendation.
Contact Baldor application engineering for special lubricants or further clarifications.

Baldor District Offices Baldor District Offices

UNITED STATES
ARIZONA
 4211 S 80th PLACE
 PHOENIX, AZ 85040
 PHONE: 602-944-0700
 FAX: 602-470-0064

ARKANSAS
CLARKSVILLE
 1001 COLLINGWOOD AVE
 CLARKSVILLE, AR 72830
 PHONE: 479-754-9108
 FAX: 479-754-9205

CALIFORNIA
LOS ANGELES
 6680 FLOTTILLA
 COMMERCE, CA 90040
 PHONE: 323-724-6771
 FAX: 323-721-5859

HAWAII
HILO
 2109S FORBES STREET
 HILO, HI 96720
 PHONE: 957-935-8900
 FAX: 957-935-8910

COLORADO
DENVER
 3855 Forestry Street
 Denver, CO 80207
 PHONE: 303-623-0172
 FAX: 303-585-5172

CONNECTICUT
WALLINGFORD
 66 SOUTH TURNPIKE ROAD
 WALLINGFORD, CT 06492
 PHONE: 203-269-1954
 FAX: 203-269-5465

FLORIDA
TAMPA/MIAMI
 3905 EAST 11TH AVENUE
 TAMPA, FL 33605
 PHONE: 813-247-5078
 FAX: 813-247-2984

GEORGIA
ATLANTA
 62 TECHNOLOGY DR
 ALPHARETTA, GA 30005
 PHONE: 770-472-8300
 FAX: 770-772-7200

ILLINOIS
CHICAGO
 4 SAMAIONS COURT
 BOLLINGBROOK, IL 60440
 PHONE: 630-295-4400
 FAX: 630-228-9420

INDIANA
INDIANAPOLIS
 5525 W. WINNECOTA STREET
 INDIANAPOLIS, IN 46241
 PHONE: 317-246-5100
 FAX: 317-246-5110

IOWA
DES MOINES
 6880 SANTA BARBARA RD.
 DES MOINES, IA 50316
 PHONE: 515-283-8829
 FAX: 515-283-6515

MARYLAND
BALTIMORE
 6880 SANTA BARBARA RD.
 SUITE 22/24
 ELKRIODE, MD 21075
 PHONE: 410-519-2135
 FAX: 410-519-2977

MASSACHUSETTS
BOSTON
 6 PULLMAN STREET
 WORCESTER, MA 01606
 PHONE: 508-854-0708
 FAX: 508-854-6291

MICHIGAN
DETROIT
 5993 Progresshite
 STERLING HEIGHTS, MI 48312
 PHONE: 586-978-9800
 FAX: 586-978-9999

MINNESOTA
DALLAS
 21801 14TH AVE. NORTH
 ROGERS, MN 55374
 PHONE: 763-428-3833
 FAX: 763-428-4551

MISSOURI
ST LOUIS
 422 INDUSTRIAL DRIVE
 ST LOUIS, MO 63043
 PHONE: 314-281-9810
 FAX: 314-281-7690

KANSAS CITY
 1501 BEDFORD AVENUE
 NORTH KANSAS CITY, MO 64116
 PHONE: 816-987-0272
 FAX: 816-981-2135

NEW YORK
NEW YORK
 ONE ELLIS DRIVE
 ALBURN, NY 13021
 PHONE: 315-565-3403
 FAX: 315-563-9823

NORTH CAROLINA
GREENSBORO
 628 RHEINGOODS ROAD
 GREENSBORO, NC 27406
 PHONE: 336-272-5104
 FAX: 336-273-6289

OHIO
CINCINNATI
 2929 CRESCENTVILLE ROAD
 WEST CHESTER, OH 45069
 PHONE: 513-771-2800
 FAX: 513-771-2219

CLEVELAND
 8609 FREEWAY DRIVE
 MACEDONIA, OH 44065
 PHONE: 330-488-4778
 FAX: 330-488-4778

OKLAHOMA
TULSA
 1710 S. Baden, Suite 140
 TULSA, OK 74106
 PHONE: 918-365-8320
 FAX: 918-365-8338

OREGON
PORTLAND
 20383 SW AVERY COURT
 TUALATIN, OR 97062
 PHONE: 503-961-9010
 FAX: 503-961-9012

PENNSYLVANIA
PENNSYLVANIA
 1035 THOMAS BUSCH
 MEMORIAL HIGHWAY
 PENNSAUKEN, NJ 08110
 PHONE: 856-661-1442
 FAX: 856-663-6363

PITTSBURGH
 159 PROKINENCE DRIVE
 NEW KENSINGTON, PA 15088
 PHONE: 724-888-0092
 FAX: 724-888-0094

TEXAS
MEMPHIS
 4000 WINCHESTER ROAD
 MEMPHIS, TN 38118
 PHONE: 901-356-2020
 FAX: 901-356-3914

UTAH
DALLAS
 DALLAS TX 75247
 PHONE: 214-634-7271
 FAX: 214-634-8874

HOUSTON
 10355 W. Luberford Rd.
 Houston, TX 77041
 PHONE: 281-971-6500
 FAX: 281-971-6510

SALT LAKE CITY
 2220 SOUTH HAN STREET
 SALT LAKE CITY, UT 84115
 PHONE: 801-632-0172
 FAX: 801-632-8911

WISCONSIN
MILWAUKEE
 2725 SOUTH 163RD STREET
 NEW BERLIN, WI 53151
 PHONE: 262-794-6940
 FAX: 262-784-1215

INTERNATIONAL SALES
PORT SMITH, AR
 2000 W. 14TH STREET
 PORT SMITH, AR 72992
 PHONE: 479-646-4711
 FAX: 479-648-5895

CANADA
EDMONTON, ALBERTA
 4033 92 STREET
 EDMONTON, ALBERTA T6E 6R8
 PHONE: 780-424-4900
 FAX: 780-424-2800

TORONTO
OKAYVILLE, ONTARIO
 2750 COVENTRY ROAD
 OKAYVILLE, ONTARIO L9H 8R1
 PHONE: 905-828-3301
 FAX: 905-829-3302

MONTREAL, QUEBEC
 5155, J.A. Bombardier
 Ste-Hubert(Quebec) Canada
 Phone: 514-633-2711
 FAX: 514-633-8639

VANCOUVER, BRITISH COLUMBIA
 1538 KEBEL WAY
 PORT COQUITLAM
 BRITISH COLUMBIA V3C 9M6
 PHONE: 604-421-2822
 FAX: 604-421-2822

WINNIPEG, MANITOBA
 54 PRINCESS STREET
 WINNIPEG, MANITOBA R3B 1K2
 PHONE: 204-942-5205
 FAX: 204-956-4251

AUSTRALIA
 UNIT 3, 6 STANTON ROAD
 SEVEN HILLS, NSW 2147,
 AUSTRALIA
 PHONE: (61) 21 9674-6465
 FAX: (61) 21 9674-6466

UNIT 8, KELLETTS ROAD
 ROYVILLE, VICTORIA, 3178
 AUSTRALIA
 PHONE: (61) 3 9753 4385
 FAX: (61) 3 9753 4386

ESALVADOR
 RESIDENCIAL ENRIQUES DE SUZA
 POL. 1974
 SAN SALVADOR,
 EL SALVADOR
 PHONE: +503 2288-1519
 FAX: +503 2288-1518

CHILE
 Lustiñape/Ojeda186,
 d402 - Providencia
 Santiago, Chile
 Phone: +56 2 816 8900
 Fax: +56 2 1 5760 5335

CHINA
 1488 Spangsheng road
 SongjiangINDUSTRIAL ZONE
 Shanghai201613, China
 PHONE: +86 21 5760 5335
 Fax: +86 21 5760 5338

GERMANY
 DRESELSTRASSE 22
 485551 KIRCHHEIM
 MUNICH, GERMANY
 PHONE: +49 89 90 50 9492
 FAX: +49 89 90 50 9492

INDIA
 14, COMMERCIAL AVENUE
 MAHAGANESH COLONY
 PAUD ROAD
 PUNE - 411038
 MAHARASHTRA, INDIA
 PHONE: +91 20 28 45 27 17 / 18
 FAX: +91 20 28 45 27 19

ITALY
 Bellavista AG
 SUCCURSIALE DI Mendisio
 V.leDromoli, 20A
 CH-8900 Mendisio
 Switzerland
 Phone: 0041 91 640 99 50
 FAX: 0041 91 630 28 33

JAPAN
 2-21-1 TBSI RIVU-A-CHO,
 KANAGAWA-KU
 YOKOHAMA, 221-0835, JAPAN
 PHONE: 81-45-412-4905
 FAX: 81-45-412-4507

MEXICO
LEON, Guanajuato
 KM. 2.0 BLVD. AEROPUERTO
 LEON 37365, GUANAJUATO,
 MEXICO
 PHONE: +52 477 761 2030
 FAX: +52 477 761 2010

MIDDLE EAST & NORTH AFRICA
 VSE INTERNATIONAL CORP
 P. O. BOX 5618
 BURFALO GROVE, IL 60089-5618
 PHONE: 630 298 5947
 FAX: 630 590 5367

PANAMA
 MIE RICARDO J. ALFARO
 EDIFICIO SIM TOWERS MALL
 PISO 2, LOCAL 56
 CiudadPanama, Panama
 PHONE: +507 238-5155
 Fax: +507 238-0591

SINGAPORE
 18/KA BUKIT ROAD 3, #02-09
 THE TRADE CENTRE, SINGAPORE
 CENTRE SINGAPORE 19970
 PHONE: (65) 9744 2272
 FAX: (65) 9747 1708

SWITZERLAND
 POSTFACH 73
 SCHUTZENSTRASSE 89
 CH-8245 FELDENTHAL
 SWITZERLAND
 PHONE: +41 52 424 7100
 FAX: +41 52 639 2394

TAIWAN
 #F, No.78, Wenshan1stStreet,
 NanShanDistrict,
 TaichungCity408
 Taiwan R.O.C.
 PHONE: (886) 4 239 4235
 FAX: (886) 4 239 0463

UNITED KINGDOM
 6 BRISTOL DISTRIBUTION PARK
 HAWKEY DRIVE
 BRISTOL BS32 0BF U.K.
 PHONE: +44 1454 880000
 FAX: +44 1454 889001

VENEZUELA
 Av. Troma, Chaguallago, Urb.
 Caracas, 1070
 Venezuela
 Phone: +58 414 114 8623
 mobile: +58 414 114 8623



BALDOR ELECTRIC COMPANY
World Headquarters
P.O. Box 2400 Fort Smith, AR 72901-2400
(479) 646-4711 Fax (479) 648-5792
www.baldor.com

© 2009 Baldor Electric Company
MN408

All rights reserved. Printed in USA
3/09

AC & DC Motor Installation & Maintenance

Safety Notice Be sure to read and understand all of the Safety Notice statements in MN408. A copy is available at:
http://www.baldor.com/support/literature_load.asp?ManNumber=MN408

ACCEPTANCE

Thoroughly inspect this equipment before accepting shipment from the transportation company. If any damage or shortage is discovered do not accept until noted on the freight bill. Report all damage to the freight carrier.

SAFETY

Eye bolts, lifting lugs or lifting openings, if provided, are intended only for lifting the motor and motor mounted standard accessories not exceeding, in total 30% of the motor weight. These lifting provisions should never be used when lifting or handling the motor and driven equipment. Eye bolt lifting capacity rating is based on a lifting alignment coincident with eye bolt center line. Eye bolt capacity reduces as deviation from this alignment is increased. Be sure eye bolts are tight and prevented from turning before lifting.

INSTALLATION OUTSIDE THE USA:

Refer to MN408 and MNT 383 for Compliance with European Directives. Copies are available at:

http://www.baldor.com/support/literature_load.asp

MOTOR ENCLOSURE

ODP, **Open drip proof** motors are intended for use in clean, dry locations with adequate supply of cooling air. These motors should not be used in the presence of flammable or combustible materials. Open motors can emit flame and/or molten metal in the event of insulation failure.

TEFC, **totally enclosed** motors are intended for use where moisture, dirt and/or corrosive materials are present in indoor and outdoor locations.

Explosion protected motors, as indicated by a Nationally Recognized Testing Laboratory Certification mark and marking with Class, Division and Temperature Code are intended for installation in hazardous locations as described in Article 500 of the NEC. Refer to MN408 for more details.

MOUNTING

Foot mounted machines should be mounted to a rigid foundation to prevent excessive vibration. Shimms may be used if location is uneven.

Flange mounted machines should be properly seated and aligned. Note: If improper rotation direction is detrimental to the load, check rotation direction prior to coupling the load to the motor shaft.

For V-belt drive, mount the sheave pulley close to the motor housing. Allow clearance for end to end movement of the motor shaft. Do not overtighten belts as this may cause premature bearing failure or shaft breakage.

Direct coupled machines should be carefully aligned and the shaft should rotate freely without binding.

GENERAL

The user must select a motor starter and overcurrent protection suitable for this motor and its application. Consult motor starter application data as well as the National Electric Code and/or applicable local codes. Special motors for use by United States Government including special specifications, master plans, etc. refer to the applicable master plans and specifications involved.

On motors received from the factory with the shaft blocked, remove blocking before operating the motor. If motor is to be reshipped alone or installed to another piece of equipment, the shaft block must be installed to prevent axial movement and prevent brinnelling of the bearings during shipment.

TESTING

If the motor has been in storage for an extensive period or has been subjected to adverse moisture conditions, check the motor insulation resistance with a meg ohm meter. Depending on storage conditions it may be necessary to regrease or change rusted bearings. Contact Baldor District Office if resistance is less than 5 meg ohms.

WARNING: Do not touch electrical connections before

you first ensure that power has been disconnected. Electrical shock can cause serious or fatal injury.

WARNING: Be sure the system is properly grounded before applying power. Electrical shock can cause serious or fatal injury.

INSTALLATION

This motor must be installed in accordance with National Electric Code, NEMA MG-2, IEC standards and local codes.

WIRING

Connect the motor as shown in the connection diagrams. If this motor is installed as part of a motor control drive system, connect and protect the motor according to the control manufacturers diagrams. Refer to MN408 for additional details on lead marking. The wiring, fusing and grounding must comply with the National Electrical Code or IEC and local codes. When the motor is connected to the load for proper direction of rotation and started, it should start quickly and run smoothly. If not, stop the motor immediately and determine the cause. Possible causes are: low voltage at the motor, motor connections are not correct or the load is too heavy. Check the motor current after a few minutes of operation and compare the measured current with the nameplate rating.

GROUNDING

Ground the motor according to NEC and local codes. In the USA consult the National Electrical Code, Article 430 for information on grounding of motors and generators, and Article 250 for general information on grounding. In making the ground connection, the installer should make certain that there is a solid and permanent metallic connection between the ground point, the motor or generator terminal housing, and the motor or generator frame. In non-USA locations consult the appropriate national or local code applicable.

ADJUSTMENT

The neutral is adjustable on some DC motors. AC motors have no adjustable parts.

Noise

For specific sound power or pressure level information, contact your local Baldor representative.

VIBRATION

This motor is balanced to NEMA MG1, Part 7 standard.

BRUSHES (DC Motors)

Periodically, the brushes should be inspected and all brush dust blown out of the motor. If a brush is worn $1/2$ (length specified in renewal parts data), replace the brushes. Reassemble and seat the new brushes using a brush seating stone. Be sure the rocker arm is set on the neutral mark.

WARNING: Guards must be installed for rotating parts such as couplings, pulleys, external fans, and unused shaft extensions, should be permanently guarded to prevent accidental contact by personnel. Accidental contact with body parts or clothing can cause serious or fatal injury.

INSPECTION

Before connecting the motor to an electrical supply, inspect for any damage resulting from shipment. Turn the shaft by hand to ensure free rotation. Motor leads must be isolated before the shaft will turn freely on permanent magnet motors.

DRAIN PLUGS

Condensation drain plugs are provided at four points on each endplate for various motor mounting configurations. For Washdown and totally enclosed, fan cooled or non-ventilated motors, the plugs in the lowest portion of the ends shields should be removed for operation (unless the motor has special stainless steel drains). All drains are located in the lowest portion of the ends shields.

MOUNTING

Mount the motor on a foundation sufficiently rigid to prevent excessive vibration. Grease lubricated ball bearing motors may be mounted with the feet at any angle. After careful alignment, bolt motor securely in place. Use shim to fill any unevenness in the foundation. Motor feet should sit solidly on the foundation before mounting bolts are tightened.

IP (Ingress Protection)

IP designations include two numerals, the first characteristic numeral is for ingress solid bodies and from dust. The second for ingress protection from liquid – water. Motors marked less than IP23 require additional protection from water.

GUARDING

After motor installation is complete, a guard of suitable dimensions must be constructed and installed around the motor/gearmotor. This guard must prevent personnel from coming in contact with any moving parts of the motor or drive assembly but must allow sufficient cooling air to pass over the motor.

If a motor mounted brake is installed, provide proper safeguards for personnel in case of brake failure. Brush inspection plates and electrical connection cover plates or lids, must be installed before operating the motor.

STARTING

Before starting motor remove all unused shaft keys and loose rotating parts to prevent them from flying off. Check direction of rotation before coupling motor to load. The motor should start quickly and run smoothly and with little noise. If the motor should fail to start the load may be too great for the motor, the voltage is low or the motor has been miswired. In any case immediately shut motor off and investigate the cause.

ROTATION

To reverse the direction of rotation, disconnect and lockout power and interchange any two of the three AC power leads for three phase motors. For two-phase four wire, disconnect and lockout power and interchange the AC line leads on any one phase. For two phase three wire, disconnect and lockout power and interchange phase one and phase two AC line leads.

Maintenance Procedures

WARNING: Do not touch electrical connections before you first ensure that power has been disconnected. Electrical shock can cause serious or fatal injury.

WARNING: Surface temperatures of motor enclosures may reach temperatures which can cause discomfort or injury to personnel accidentally coming into contact with hot surfaces. Protection should be provided by the user to protect against accidental contact with hot surfaces. Failure to observe this precaution could result in bodily injury.

Lubrication Information

This is a ball or roller bearing motor. The bearings have been lubricated at the factory. Motors that do not have regrease capability are factory lubricated for the normal life of the bearings. **Washdown motors can not be lubricated.**

Lubricant

Baldor motors are pregreased, normally with Mobil Polyrex EM unless stated on nameplate. Do not mix lubricants due to possible incompatibility. Look for signs of lubricant incompatibility, such as extreme sounpiness visible from the grease relief area. If other greases are preferred, check with local Baldor representative for recommendations. **Relubrication Intervals (For motors with regrease capability)**

New motors that have been stored for a year or more should be relubricated. Lubrication is also recommended at these intervals.

LUBRICATION INSTRUCTIONS

Cleanliness is important in lubrication. Any grease used to lubricate anti friction bearings should be fresh and free from contamination. Properly clean the grease inlet area of the motor to prevent grease contamination.

1. Select service condition from Table 1.
2. Select lubrication frequency from Table 2.

LUBRICATION PROCEDURE

Bearings should be lubricated while stationary and the motor is warm.

1. Locate the grease inlet, clean the area, and replace the pipe plug with a grease fitting.
2. Locate and remove the grease drain plug, if provided.
3. Add the recommended volume of recommended lubricant until clean grease appears at the grease drain, at the grease relief, or along the shaft opening.
4. Replace the grease inlet plug and run the motor for two hours.
5. Replace the grease drain plug.

SPECIAL APPLICATIONS

For special temperature applications, consult your Baldor District Office.

Table 1 Service Conditions

Severity of Service	Ambient Temperature Maximum	Atmospheric Contamination	Type of Bearing
Standard	40° C	Clean, Little Corrosion	Deep Groove Ball Bearing
Severe	50° C	Moderate dirt, Corrosion	Ball Thrust, Roller
Extreme	>50° C* or Class H Insulation	Severe dirt, Abrasive dust, Corrosion	All Bearings
Low Temperature	<-30° C**		

* Special high temperature grease is recommended. ** Special low temperature grease is recommended.

Table 2 Lubrication Frequency (Ball Bearings)

NEMA / (IEC) Frame Size	Rated Speed - RPM					
	10000	6000	3600	1800	1200	900
Up to 210 incl. (132)	**	2700 Hrs.	5500 Hrs.	12000 Hrs.	18000 Hrs.	22000 Hrs.
Over 210 to 280 incl. (180)		**	3600 Hrs.	9500 Hrs.	15000 Hrs.	18000 Hrs.
Over 280 to 360 incl. (225)		**	*2200 Hrs.	7400 Hrs.	12000 Hrs.	15000 Hrs.
Over 360 to 5000 incl. (300)		**	*2200 Hrs.	3500 Hrs.	7400 Hrs.	10500 Hrs.

* Relubrication intervals are for ball bearings. For vertically mounted motors and roller bearings, divide the relubrication interval by 2.
 ** For motors operating at speeds greater than 3600 RPM, contact Baldor for relubrication recommendations.

Table 3 Lubrication Interval Multiplier

Severity of Service	Multiplier
Standard	1.0
Severe	0.5
Extreme	0.1
Low Temperature	1.0

Table 4 Amount of Grease to Add

Frame Size NEMA (IEC)	Bearing Description (Largest bearing in each frame size)				
	Bearing	OD D mm	Width B mm	Weight of grease to add ounce (gram)	Volume of grease to add inches ³ teaspoon
Up to 210 incl. (132)	6307	80	21	0.30 (8.4)	0.6 2.0
Over 210 to 280 incl. (180)	6311	120	29	0.61 (17.4)	1.2 3.9
Over 280 to 360 incl. (200)	6313	140	33	0.81 (23.1)	1.5 5.2
Over 360 to 5000 incl. (300)	NU322	240	50	2.12 (60.0)	4.1 13.4

Weight in grams = 0.005 DB

Typical IEC vs NEMA Lead Marking

Single Phase Non-Reversible
Refer to the connection diagram provided on the Baldor motor.



Single Phase Reversible



Dual Voltage Reversible

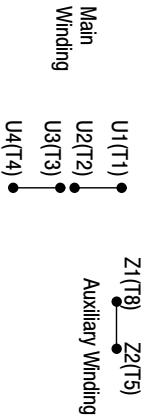

Three Phase

For single winding 3 phase motors, lead markings can be directly translated between IEC and NEMA designations.

For these motors, the lead markings are:
 U1=T1 U2=T4 U3=T7 U4=T10
 V1=T2 V2=T5 V3=T8 V4=T11
 W1=T3 W2=T6 W3=T9 W4=T12

Refer to the connection diagram provided on the Baldor motor. Some examples are as follows:

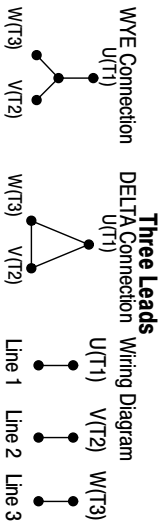

Six Leads

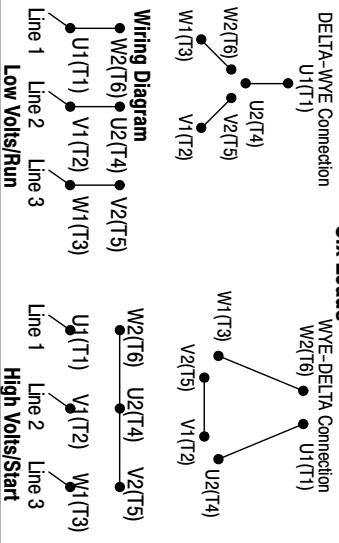

DC Motors
Lead markings can be translated between IEC and NEMA designations as follows:

	NEMA	IEC
Armature	A1, A2	A1, A2
Series Field	S2, S2	D1, D2
Shunt Field	F1, F2	E1, E2

Refer to the connection diagram provided on the Baldor motor.

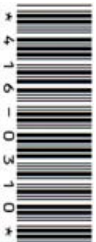

World Headquarters

P.O. Box 2400 Fort Smith, AR 72902-2400 USA Ph: (1) 479.646.4711, Fax: (1) 479.648.5792

www.baldor.com

© 2009 Baldor Electric Company
MNA416

All rights reserved. Printed in USA

3/10

4 Installation & Maintenance

MNA416