

BALDOR® • **RELIANCE**

Product Information Packet

EM4115T-12

50HP,1775RPM,3PH,60HZ,326T,1272M,TEFC,F1

Copyright © All product information within this document is subject to Baldor Electric Company copyright © protection, unless otherwise noted.

Part Detail							
Revision:	A	Status:	PRD/A	Change #:		Proprietary:	No
Type:	AC	Prod. Type:	1272M	Elec. Spec:	12WGY340	CD Diagram:	
Enclosure:	TEFC	Mfg Plant:		Mech. Spec:	12C51	Layout:	
Frame:	326T	Mounting:	F1	Poles:	04	Created Date:	08-03-2010
Base:	RG	Rotation:	R	Insulation:	F	Eff. Date:	05-04-2011
Leads:	12#8	Literature:		Elec. Diagram:		Replaced By:	

Nameplate NP2138L							
CAT.NO.	EM4115T-12	P/N		ENCLOSURE	TEFC		
SPEC.	12C051Y340G1	CC	010A	FRAME	326T	S/N	
HP	50	CLASS	F	HZ	60		
RPM	1775	PH	3	DES	A		
VOLT	230/460	KVA-CODE	G	ODE BRG	6311	DE BRG	6312
AMP	116/58	USABLE AT 208V					
RATING	40C AMB-CONT	GREASE	POLYREX EM				
NEMA-NOM-EFF	94.5	PF	85	SER.F.	1.15		
HTR-VOLTS		HTR-AMPS		MAX. SPACE HEATER TEMP.			

Parts List		
Part Number	Description	Quantity
SA200838	SA 12C051Y340G1	1.000 EA
RA188149	RA 12C051Y340G1	1.000 EA
09FN3001B03SP	EXTERNAL FAN, PLASTIC	1.000 EA
S/P107-000-004	SUPER-E(284 FR. & UP)-CL PLANT,POLYREX E	1.000 EA
10CB3001	CONDUIT BOX CAST W/2.500 LEAD HOLE	1.000 EA
12GS1000SP	GASKET	1.000 EA
10XN3118K12	5/16-18 X .75 GRADE 5, ZINC PLATED	4.000 EA
HW1001A31	LOCKWASHER 5/16, ZINC PLT.591 OD, .319 I	4.000 EA
WD1000B16	KPA-4C BURNDY TERMINAL	1.000 EA
51XF2520A08	SCREW, HEX SER SLT HD, ZN 1/4-20 X .50 L	1.000 EA
HA3400A13SP	STUD, 1/2-13 X 7" WELKER	4.000 EA
HW1001A50	LOCKWASHER 1/2, ZINC PLT,.879 OD, .509 I	4.000 EA
HW5100A13	W4627-047 WVY WSHER	1.000 EA
10XN3118K36	5/16-18 X 2.25" HEX HD, GRADE 5	2.000 EA
HW1001A31	LOCKWASHER 5/16, ZINC PLT.591 OD, .319 I	2.000 EA
12EP1106A01	PU ENDPLATE, MACH 324-6T	1.000 EA
HW4600B41	V-RING SLINGER 2.125 X 2.880 X 0.280	1.000 EA
10XN5013K28	1/2-13 X 1.75 HEX HEAD MACH SCREW,GRAD	4.000 EA
HW1001A50	LOCKWASHER 1/2, ZINC PLT,.879 OD, .509 I	4.000 EA
10XN3118K40	5/16-18 X 2.50" HEX HD, GRADE 5	4.000 EA
HW1001A31	LOCKWASHER 5/16, ZINC PLT.591 OD, .319 I	4.000 EA
12FH1002SP	FAN COVER, CAST QF,WAUPACA QUALITY	1.000 EA
HW1001A50	LOCKWASHER 1/2, ZINC PLT,.879 OD, .509 I	4.000 EA
XY5013A12	NUT,1/2-13,HEX,STEEL,ZINCPLATED	4.000 EA

Parts List (continued)		
Part Number	Description	Quantity
10CB3500SP	CONDUIT BOX LID, CAST	1.000 EA
10GS1000SP	GASKET, CONDUIT BOX LID	1.000 EA
51XW2520A12	.25-20 X .75, TAPTITE II, HEX WSHR SLTD	4.000 EA
HW2501H33	KEY, 1/2 SQ X 3.875	1.000 EA
LB1115	LABEL,LIFTING DEVICE	1.000 EA
LB5040	INSTRUCTION TAG, AC & DC	1.000 EA
12EP1107A05	FR ENDPLATE, MACH 324-6T	1.000 EA
HW4500A21	1618BALEMITE FITTING 825 UNIVERSAL	1.000 EA
HA4017A01	1/8 X 4 GREASE EXT (F/S)	1.000 EA
HW4500A17	317400 ALEMITE GREASE RELIEF	1.000 EA
HA4001A01SP	DRAIN PLUG, PLASTIC (MICRO PLAS)	1.000 EA
HA4051A00	PLASTIC CAP FOR GREASE FITTING	1.000 EA
MJ1000A75	GREASE, POLYREX EM EXXON	0.200 LB
HW4500A03	GREASE FITTING, .125 NPT 1610(ALEMITE) 8	1.000 EA
HW4500A17	317400 ALEMITE GREASE RELIEF	1.000 EA
HA4001A01SP	DRAIN PLUG, PLASTIC (MICRO PLAS)	1.000 EA
HA4051A00	PLASTIC CAP FOR GREASE FITTING	1.000 EA
HW2500A25	WOODRUFF KEY USA #1008 #BLOW CARBON STEE	1.000 EA
51XB1214A20	12-14X1.25 HXWSSLD SERTYB	1.000 EA
MG1000Y03	WILKO 689.710 GOLD PAINT SUPER E	0.080 GA
85XU0407A04	#4-7 X 1/4 DRIVE PIN	4.000 EA
LB1119	WARNING LABEL	1.000 EA
LB1125C02	SUPER-E (STOCK CTN LABEL SUPER-E WITH FL	4.000 EA
LB1357	ENERGY GUIDE LABEL (BOX LABEL)	1.000 SH

Parts List (continued)		
Part Number	Description	Quantity
LC0104A01	CONNECTION DIAGRAM	1.000 EA
NP2138L	ALUM SUPER-E UL CSA-EEV PREM CC (300	1.000 EA
12PA1000	PACKAGING GROUP COMBINED PRINT PK1024A06	1.000 EA

Performance Data at 460V, 60Hz, 50.0HP (Typical performance - Not guaranteed values)

General Characteristics

Full Load Torque:	147.0 LB-FT	Start Configuration:	DOL
No-Load Current:	19.8 Amps	Break-Down Torque:	396.0 LB-FT
Line-line Res. @ 25°C.:	0.10889 Ohms A Ph / 0.0 Ohms B Ph	Pull-Up Torque:	183.0 LB-FT
Temp. Rise @ Rated Load:	64 C	Locked-Rotor Torque:	254.0 LB-FT
Temp. Rise @ S.F. Load:	79 C	Starting Current:	397.0 Amps

Load Characteristics

% of Rated Load	25	50	75	100	125	150	S.F.
Power Factor:	53.0	74.0	83.0	86.0	87.0	87.0	87.0
Efficiency:	91.3	94.3	94.8	94.6	94.0	93.1	94.2
Speed:	1794.5	1789.3	1783.5	1777.5	1770.7	1761.5	1773.0
Line Amperes:	24.2	33.5	44.7	57.6	71.5	90.0	65.9

Performance Graph at 460V, 60Hz, 50.0HP Typical performance - Not guaranteed values

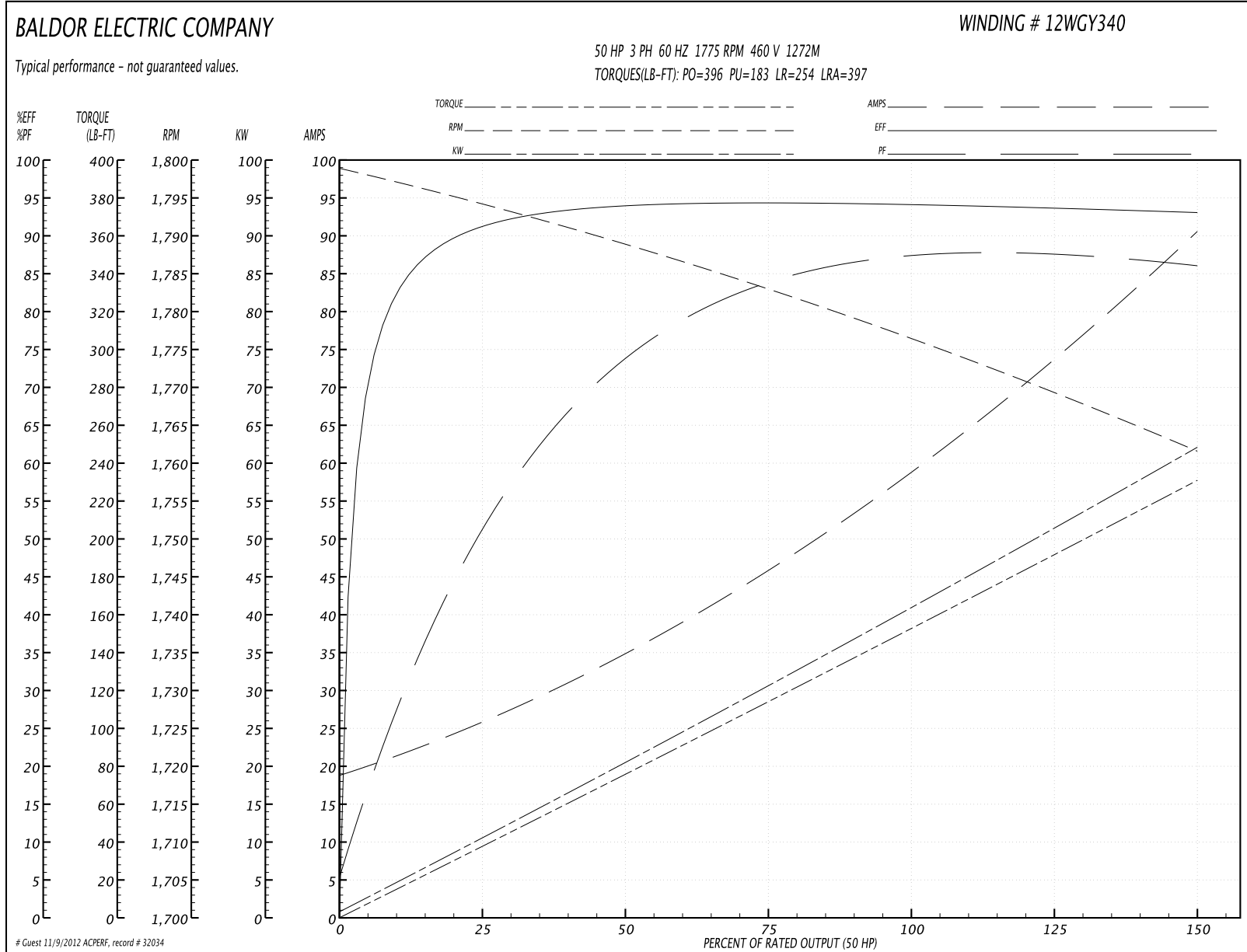

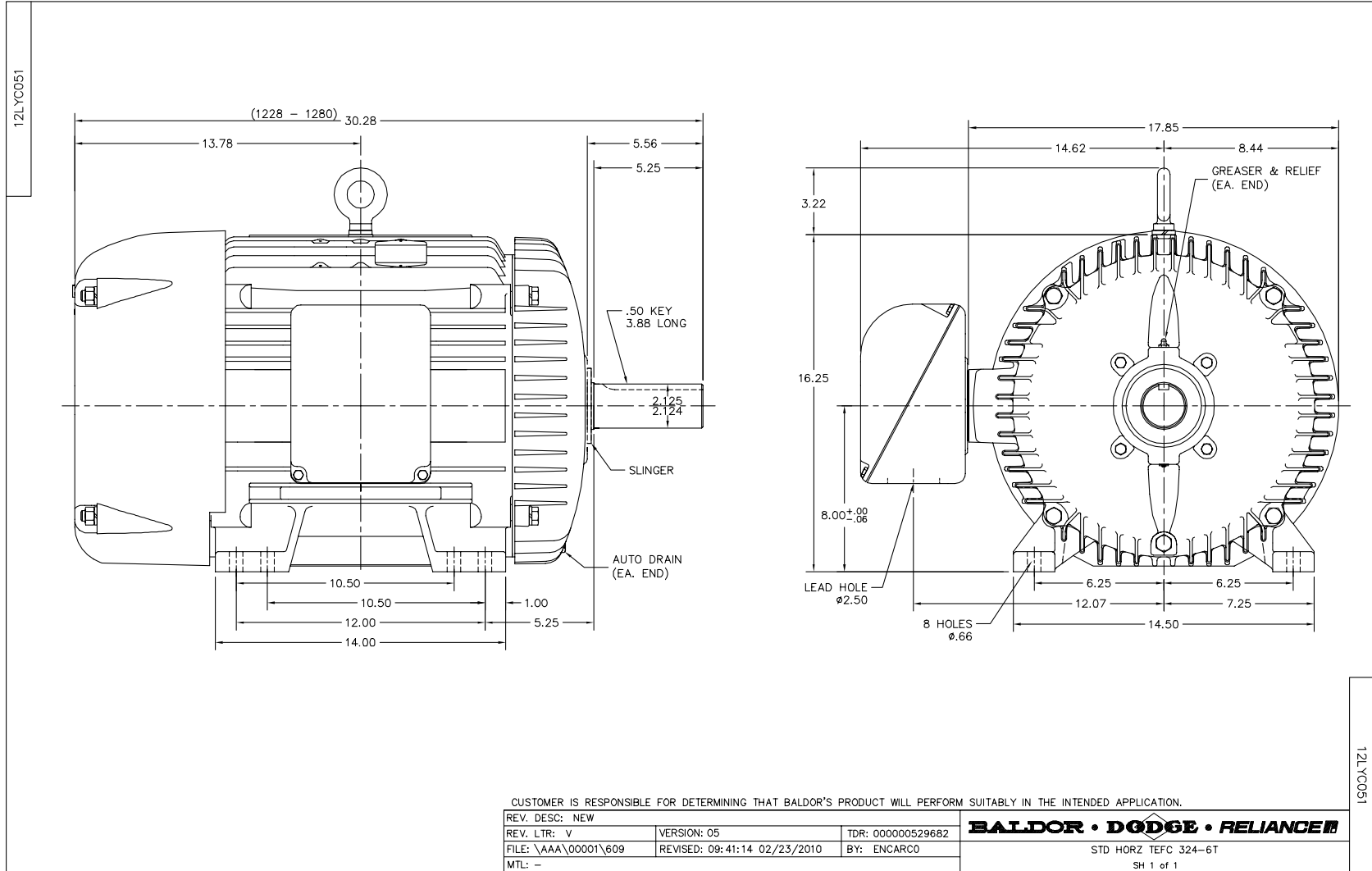

CD0104

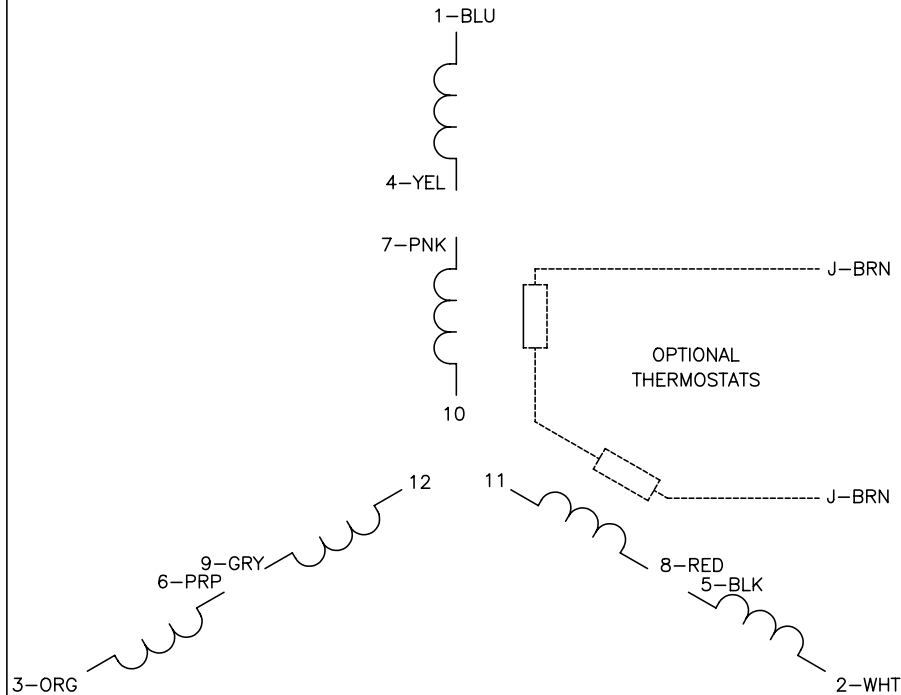

LOW VOLTAGE

START (2Y)

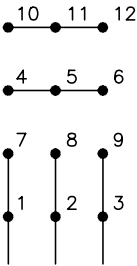

LINE

RUN (2D)

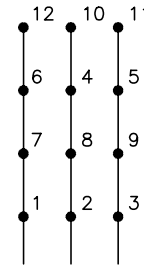

LINE

HIGH VOLTAGE

START (1Y)

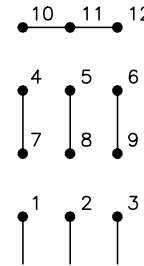

LINE

RUN (1D)

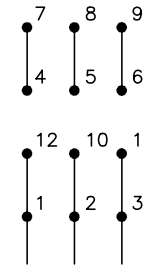

LINE

NOTES:

1. INTERCHANGE ANY TWO LINE LEADS TO REVERSE ROTATION.
2. OPTIONAL THERMOSTATS ARE PROVIDED WHEN SPECIFIED.
3. ACTUAL NUMBER OF INTERNAL PARALLEL CIRCUITS MAY BE A MULTIPLE OF THOSE SHOWN ABOVE.
4. LEAD COLORS ARE OPTIONAL. LEADS MUST ALWAYS BE NUMBERED AS SHOWN.

REV. DESC: REVISE TO SHOW OPTIONAL COLORS			
REV. LTR: C	BY: JLP	REVISED: 01/19/99 4:24	TDR: 0171435
CD0104		FILE: AAA00008377	MDL: -
		MTL: -	

BALDOR ELECTRIC Co.

3PH, DV, 12 LEADS, Y START/D RUN

CD0104