



Low voltage DC drives

ABB DC Drives DCS800, 10 to 4000 hp Catalog

Selecting and ordering your drive

Type designation is a unique reference number that clearly identifies the drive by construction, power and voltage rating and selected options. Using the type designation you can specify your drives from the wide range of options available. Options are added to the type designation using the corresponding “plus” (+) code.

key below or contact your local ABB drives sales office and let them know what you want.

Build up your own ordering code using the type designation

Type designation:

DCS800 - S01 - 0680 - 05 [] + XXXX

Product series

Type

- A0 = Enclosed converter
- EP = Panel mounted converter
- R0 = Rebuild kit
- S0 = 3-phase converter module

Bridge type

- 1 = non-regenerative(2-Q)
- 2 = regenerative (4-Q)

Rated Current

Current rating of drive unit (Amps)

Rated Input Voltage

- 05 = 230...525 V AC
- 06 = 270...600 V AC
- 07 = 315...690 V AC
- 08 = 360...800 V AC
- 10 = 450...990 V AC
- 12 = 540...1200 V AC

Power Terminal Connection

- Blank = No option (D1 - D6)
- L = Left side power terminals
- R = Right side power terminals

Additional Factory Installed Options

Contents

ABB low voltage DC drive, DCS800

ABB DCS800 drive	4
Overview	4
Power Converter Modules	5
Panel Drive	6
Enclosed Converter	7
Rebuild and Upgrade Kits	9
Adaptive Programming and Start-up Assistants	10
DriveWindow Light	11
Commissioning Macros	13
DCS800 Firmware	14
Ratings and Specifications	15
Technical Specifications	15
Ratings	16
Dimensions and Weights	19
Hardware	21
Plug in Options	21
Feedback Options	22
Communication Options	23
External Field Supply	25
Fuse Connections	26
Line Reactors	27
Input and Output Contactors	28
Software Options / PC Tools	29
Control Builder	29
DriveWindow	30
DriveSize	31
DriveOPC	32
Remote Monitoring Tool	33
Drawings	34
Services and parts	36

Trademarks

DriveWindow is a registered trademark of ABB

Modbus is a trademark of Schneider Electric

Profibus is a trademark of Siemens

ControlNet is a trademark of ControlNet International, Ltd.

DeviceNet is a trademark of the Open DeviceNet Vendor Association.

Windows is a registered trademark of Microsoft Corp

Reliance Electric® and FlexPak® 3000 are registered trademarks of Rockwell Automation, Inc.

DC Industrial Drives Overview

ABB DC Industrial Drives

The DCS800 DC industrial drive is the latest drive from ABB, combining the newest control technology with a thyristor power platform that has been factory-proven all over the world. The DCS800 boasts a wider power range than any other DC drive on the market. The hardware and software are designed with you, the user in mind. Special features make installation and configuration simple and allow you to customize the application to your needs.

Industrial Applications

The DCS800 can be used in a wide range of industrial applications including:

- Metals
- Electrolysis
- Pulp & Paper
- Ski lifts
- Printing
- Magnets
- Material handling
- Food & Beverage
- Battery Chargers
- Test rigs
- Plastic & Rubber
- Mining

DCS800 DC Drive Promises

The drive meets the requirements of the most demanding drive applications. Embedded software functions offer upgrades to all classic installations like 12-pulse, double motor operation, and field reversal.

Highlights

- Reduced installation and commissioning work
- Internal three phase field exciter without additional external hardware (D1-D5)
- Excellent control performance up to highest dynamic application in field weakening operation
- All ACS800 PC tools (via DDCS) can be connected
- Able to be customized to your needs with Adaptive programming and with option Control Builder
- Flexible fieldbus system with built-in Modbus and numerous internally mountable fieldbus adapters
- Virtually all DCS800 component parts are suitable for recycling.

PC Tool for ABB Drives

DriveWindow Light is an easy-to-use tool for your PC for start up and maintenance of your ABB drive. It is included with every DCS800 drive and has the following features:

- User interface tool to view and set parameters
- Startup Assistant tool
- Adaptive programming (AP) tool

It supports a wide range of ABB industrial drives, including ACS350, ACS550, ACS800, DCS400, as well as the DCS800.

Main Features

- Basic control
 - Transducer and transducerless operation
 - Macros to simplify setup
 - High-speed serial via Ethernet, ControlNet, etc.
 - On/Off control with pulsed or maintained inputs
 - Field heating
 - Adaptive programming
 - Remembers two sets of motor parameters
 - Drive position display
 - Save parameter set to PC or keypad
- Motion
 - Easily switches between local control via keypad and remote control via D- I/O or high-speed serial
 - Window speed control
 - Flying start
 - Field reversal, boost and opti-torque
 - Motor pot up and down control
- Drive Configurations
 - Stand-alone
 - Master-follower (up to 10 followers)
 - 12-pulse operation
 - Hard-parallel operation (D7 only)
- Inputs and outputs
 - All user-designated inputs and outputs
 - Relay output for AC or DC contactor control
 - Motor brake control, including torque proving input
 - Motor temperature sensor monitoring
 - High speed DC breaker monitoring
- Faults and Diagnostics
 - Fault logging with time and date stamp
 - Diagnostic assistant activates when fault occurs

Power Converter Modules

Enclosure Rating

The DCS800-S0x power converter module carries a NEMA TYPE OPEN (IP00) rating and must be mounted in a protective enclosure. There are seven different frame sizes, D1 through D7, graduated in terms of current and voltage.

Regenerative and Non-Regenerative Drives

Non-regenerative (2-Q) power converter modules are used when motor torque is always in the same direction or when significant stopping power is not required.

This is ideal for applications such as:

- Fan or blower
- Mixer
- Mill
- Extruder

It is not possible for a 2-Q drive to slow down an inertial load. The load will stop only due to friction, windage, or another form of load resistance. Reverse direction is possible but only if torque is always in the same direction such as when raising and lowering a weight.

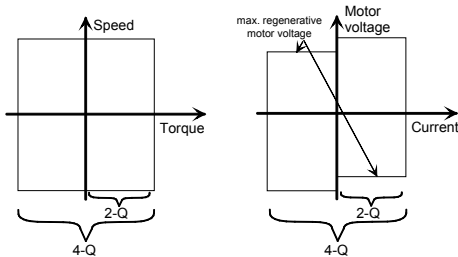

Regenerative (4-Q) power converter modules are used when motor torque can occur in either direction. This is for applications such as:

- Stop-start conveyor
- Draw Roll
- Rolling mill
- Unwinder
- Overhead crane hoist

A 4-Q drive is able to start and stop an inertial load in both forward and reverse directions.

Field Power Supplies and Fusing

Converter module sizes D1 through D4 are equipped with fused internal field power supplies. The internal field supply is optional on size D5. Sizes D6 – D7 require an external field power supply. See page 21 for details.

AC line fuses and DC armature fuses must be separately mounted. See page 24 for fuse information as well as information on other optional system components.

Voltage Selection

The output voltage of the drive depends on the connection voltage and whether a 2-Q or 4-Q drive is selected. The table below shows the maximum output voltage that will result for various input voltages for both the 2-Q and 4-Q drives.

System connection voltage	DC voltage (recommended)		Ideal DC voltage without load	Recommended DCS800 voltage class type code
	2Q	4Q		
U_{VN}	$U_{dmax\ 2-Q}$	$U_{dmax\ 4-Q}$	U_{dlo}	
[V]	[V]	[V]	[V]	
230	265	240	310	05
380	440	395	510	05
400	465	415	540	05
415	480	430	560	05
440	510	455	590	05
460	530	480	620	05
480	555	500	640	05
500	580	520	670	05
525	610	545	700	05 (D1-D4), 06
575	670	600	770	06
600	700	625	810	06
660	765	685	890	07
690	800	720	930	07
800	915	820	1060	08
990	1160	1040	1350	10
1200	1380	1235	1590	12

The maximum output voltage of a 4-Q drive can be increased up to the level of $U_{dmax\ 2-Q}$ if the torque reversal time from motor to regenerative mode is set above 300 ms.

Low Mains Voltage - (30 to 120 V) SDCS-SUB-4 (+S186)

External DC Voltage Measurement - Measures Vdc at the motor; (D1-D4) SDCS-UCM-1; (not needed D5-D7)

Analog, Digital and Encoder Interface

The drive is equipped with high-speed, high-resolution analog inputs and outputs to interface with user signals. Analog inputs are 16-bit resolution (15 plus one sign bit) which is the highest resolution in the industry.

The following interfaces are standard features:

- Analog tachometer
- Pulse encoder
- PTC or PT100 temperature sensor

Optional modules are available to increase the number of analog, digital, tachometer, encoder, and temperature sensor interfaces and for isolated interfaces.

DCS800 Panel Drive

The DCS800-EPx Panel Drive is a DCS800 power module and associated system components mounted and wired on a sub-panel and ready to be installed into an industrial enclosure. System components include AC input fuses, DC output fuses (regen only), control transformer, AC contactor, plus optional components. The drive is designed to easily replace a Reliance Electric® FlexPak® 3000 drive.

Product Offering

- 460 Vac, factory or field convertible to 230 Vac
- 10 to 500 HP with heavy duty overload ratings (150 pct for 60 sec.)
- 600 HP with normal duty ratings (110 pct for 60 sec.)
- Integral ABB AC contactor
- UL Listed with 65 kA SCCR

Panel Drive Benefits

- Space efficient multilevel panel
- Easy to maintain
- Pre-wired, pre-tested solution for smooth start ups
- Greatly simplifies the procurement process
- Module can be replaced without replacing the entire panel

Optional Features

Option	Size	Option Code
Integral line reactor *	Up to 150 hp	+E213
ABB Tmax MCP circuit breaker		+F278
ABB A-line blower motor contactor & overload	Blower from 1/2 to 15 hp	+M611 - +M641
Without AC contactor		+F250
230 Vac supply		+S235

*Reactor or isolation transformer required!

DCS800 Power Module Benefits

- Highly reliable DCS800 module drive
- Integral field supply, including field weakening
- Control Panel with 5-line display and 2 soft keys
- DriveWindows Light PC tool included

Excellent Reliance® FlexPak® 3000 Retrofit Drive

- Same bolt pattern
- Similar features
- Fits within FlexPak® 3000 clearance area
- ABB's Replacement Guide (DCS800-PHTG01U-EN) makes conversions go smoothly

Express Build Program Option

- Orders received before noon (CST) will be shipped by the end of the second business day
- Frames A & B only (5 to 75 hp)
- Customer service prior-authorization and special handling fee required.



DCS800 Enclosed Converters

The DCS800-A enclosed converters are drive modules and supporting hardware that is mounted in an enclosure, intended to power and control DC industrial machines. In addition to the drive module, the basic package typically includes the following (varies by size):

- Single-door / multi-door cabinet (IP 21, similar to NEMA 1)
- Fused disconnect / circuit breaker
- Line contactor
- Line reactor
- Control transformer and fuses
- Converter fan relay and fuses
- E-stop relay
- I/O converter board - SDCS-IOB-2x
- I/O converter board - SDCS-IOB-3
- Terminals

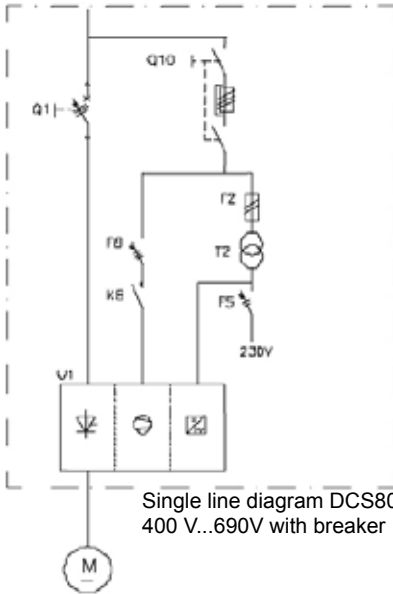

Comprehensive Product Range

DCS800-A enclosed converters are available with regenerative (4-quadrant) and non-regenerative (2-quadrant) drives in standard 6-pulse or 12-pulse configurations. The cabinets have a continuous current rating which ranges from 18 Amps up to 9800 Amps. (19,600 Amps possible with parallel units.) Supply voltage ranges from 230 to 1200 Vac.

Custom configurations are possible with a wide range of optional components, including motor blower starter, 24 Vdc supply, external field supply, multiple drives, Advant (AC 800M) controller and S800 I/O system. Contact your local ABB factory sales team for additional information and for a custom quotation.

These cabinets are not UL listed. For large projects, UL listed cabinets may be available. Contact ABB for more information.

Cabinets are built to meet CE LVD regulations and, with options, can be built to receive the CE mark.



DCS800 Enclosed Converters

Mechanics

The robust frame body is made from 12 gauge steel. All enclosure panels are 16 gauge steel. To prevent corrosion, all metal parts have hot zinc galvanization. The standard height is 83-1/2 inches (2120 mm) which includes a detachable 4-1/2 inch high hood. Cabinet widths depend on the power and size of the drive but include 200, 400, 600, 800 and 1000 mm wide bays.

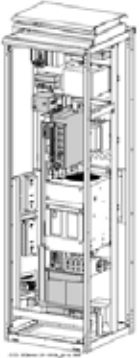

0025...0350 (D1/D2)

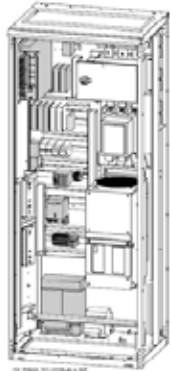

0520...1000 (D3/D4)

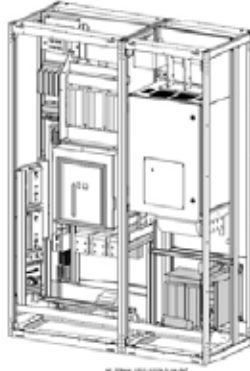

900...2000 (D5)

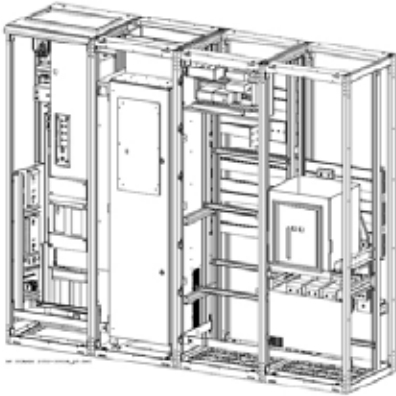

2050...3000 (D6 with breaker)

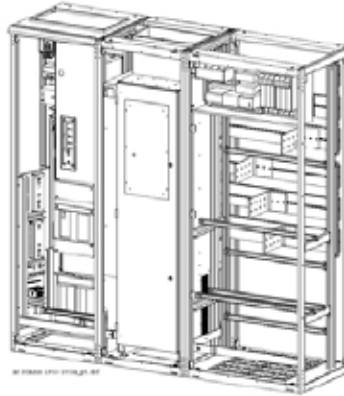

1900...3000 (D6 without breaker)

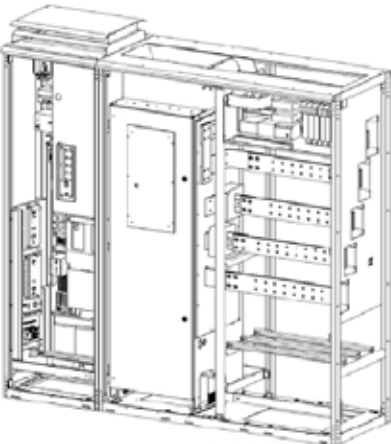

2050...3300 (D7)

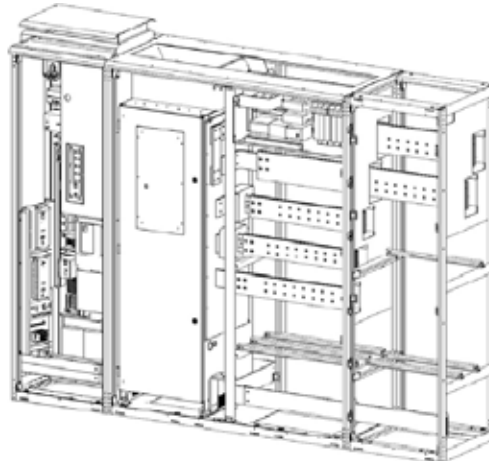

4000...5200 (D7)

DCS800 Rebuild and Upgrade Kits

The DCS800-R Rebuild or Upgrade Kit from ABB allows you to update the controls on your existing DC drive and continue to utilize the existing power section.

ABB, with the help of our channel partners, can make your existing drive look and act like a new DCS800 drive. Gain the benefits of having the latest motor control technology and high speed serial connectivity without having to replace the power section. This is an engineered solution which can have significant cost advantages over complete drive replacement, especially on large systems.

General Purpose Rebuild Kit

The DC800-R Rebuild Kit is recommended for thyristorbased power sections that are:

- 500 horsepower (800 Amps) and above
- Originally manufactured by ABB or another drive company
- Regenerative (4-quadrant) or non-regenerative (2-quadrant)
- From 1, up to 4 parallel bridges

In order to determine if your existing drive can be rebuilt, consider the following:

- Is the power section healthy?
Replacing the controls usually does not reduce the occurrence of blown fuses or over-current faults. These conditions commonly indicate that there is a malfunction in the power section. Carefully consider the benefits of upgrading compared to replacing with a full drive with a brand new warranty.
- What data is available on the existing power section?
An accurate, up-to-date schematic is essential. The schematic needs to include any changes that occurred over the years.
- Is there space to mount the retrofit components?
A panel layout diagram, along with visual inspection of the panel is needed.
- Are there any special features in the existing controller?
The DCS800 has functions to run most any application but it is important to be sure that the new controller has the functionality of the existing controller, or if other modifications will be required.

DCS500 to DCS800 Upgrade Kit

The DCS800-R Upgrade Kit is specifically designed to upgrade the controls of existing DCS500 drives.

- For frame sizes A5, A6, A7, C2b, C3, & C4
- For drives approx. 350 HP and above
- Replaces existing door, control tray and keypad

How it Works

A modern drive can be subdivided into two major sections, the power section and the controller. The power section transfers a measured amount of voltage and current from the incoming lines to the motor. The computer-based controller controls the power section, along with several other functions. The rebuild/upgrade kit replaces the existing controller with a DCS800 controller.

In addition to controlling the power section, the DCS800-R will also provide user interface (via keypad or DriveWindow Light) and encoder and/or tachometer interface, if present. After the drive is rebuilt, the complete drive system will operate like a DCS800, which may include communicating with your PLC via Ethernet, ControlNet, etc, receiving signals from switches, push-buttons and pots, and sending signals to lamps and meters.



DCS800-R Rebuild Kit

Adaptive Programming and Start-up Assistants

Adaptive Programming

Optimal Adaptability

Adaptive programming gives you the ability to customize the drive to your needs without adding more hardware. Change how a digital output works, modify speed or torque reference, or filter an analog input - all these things are possible. You program the drive with the control panel or your PC using DriveWindow Light. Adaptive programming gives you the flexibility you need to make the drive work to your specifications.

Features

- 16 programmable function blocks
- 31 Available functions:
 - Logical: AND, OR and XOR
 - Mathematical: add, mul, div, abs, max and min
 - Other: timer, switch, comparator, filter, SR, PI and user-defined warnings or faults
- Freely definable execution order
- Easy documentation
- Same as available with ACS800 AC Drives

The DCS800 DC drive offers you all this as standard features. If more function blocks are required, control builder, which uses compact flash memory, is available with expanded capacity. See page 27 for details.

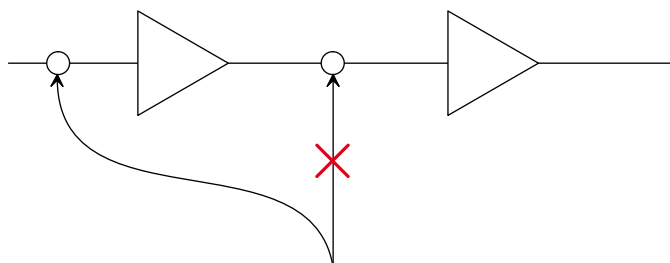

Start-Up Assistants

Faster and Easier Commissioning

The Startup Assistant is part of the standard DCS800 DC Drives software package. It guides you actively through the commissioning procedure either through the control panel or with your PC using DriveWindow Light. It is multilingual, requests data with clear and plain text messages, and sets the required parameters to your needs.

On-line Info System

To make it easier and more informative, "info system" is available at each step, helping to set the correct values for each parameter and troubleshoot the problems. It also provides you with a step-by-step reference to the printed manuals.



Features

- Easy and fast commissioning procedure
- Intelligent guide to assist you through the commissioning
- Available in 8 languages, including Spanish and French
- Info system always available
- Auto detection of connected hardware

The DCS800 DC drive offers you all this as standard features.

DriveWindow Light Startup and Maintenance Tool

PC tool for ABB drives

DriveWindow Light is an easy-to-use tool for PC-based start up and maintenance of your ABB drive. It is included with every DCS800 drive and has the following features:

- User interface tool to view and set parameters
- Startup Assistant tool
- Adaptive programming (AP) tool
- Fault Logging/Troubleshooting

It supports a wide range of ABB industrial drives, including ACS350, ACS550, ACS800, DCS400, as well as the DCS800.

Highlights

- Viewing and setting parameters in offline and online modes
- Editing, saving and downloading parameters
- Comparing parameters
- Graphical and numerical signal monitoring
- Drive control
- Start-up assistants
- DWL AP tool for DCS800 (for adaptive programming)
- All DCS800 DC drives are equipped with DriveWindow Light

Light software with Heavy Features

DriveWindow Light offers many functions in an easy-to-use package. It can be used in an offline mode, which enables parameter setting at the office even before going to the actual site. The parameter browser enables viewing, editing and saving of parameters. The parameter comparison feature makes it possible to compare parameter values between the drive and the file. With the parameter subset you can create your own parameter sets. Controlling the drive is naturally one of the features in DriveWindow Light. Drive status and fault information keeps commissioning time low.

Name	Browser	Drive/File
99.03 M1NonCur	11	0
99.11 M1NonFACur	1	0.3
7.01 ManChkWord	0	5
7.04 UsedMCW	400	475
7.06 RFE ChkWord	2	0
8.01 ManStafWord	300	331
8.02 AuxStafWord	3840	1840
8.05 D1 StafWord	0	18
9.06 AlarmWord1	3	0
10.06 MotFanAck	NotUsed	D12
10.20 ConvFanAck	NotUsed	D11
10.21 ManConAck	NotUsed	D13
11.00 Ref1Set	A1	SpeedRef2301
15.01 Indwid01	104	0
15.05 ScaleID1	5000	10000
15.08 Indwid02	106	0
16.09 USt1 Set	Extended	Compact
22.01 AccTime1	3	20
22.02 DecTime1	3	20
24.03 Kp0	50	5
24.09 TIS	280	2500
43.06 M1KpAmCur	0.08	0.1
43.07 M1TAmCur	14	50
43.08 M1DiscontCurLim	01.01	100
43.09 M1AmL	17.39	0
43.10 M1AmR	1180	0
44.01 FdChkMode	EMF	Fi

With DriveWindow Light, you can monitor up to four signals simultaneously. This can be done in both graphical and numerical format. Any signal can be set to start the monitoring from a pre-defined level.

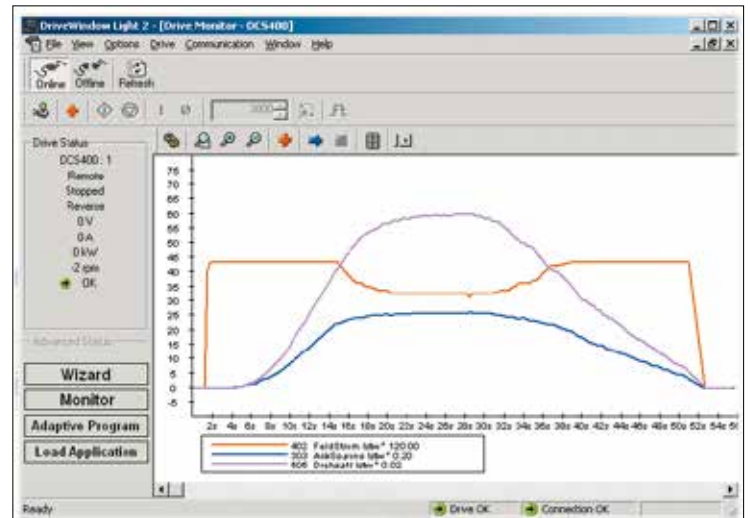
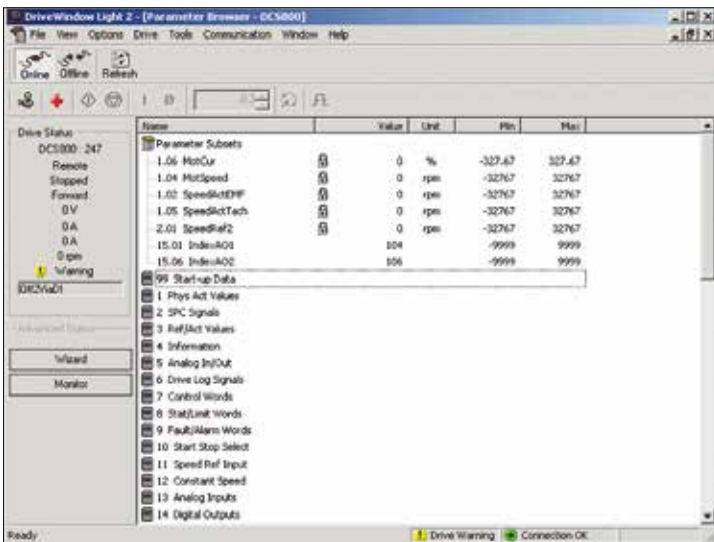

DriveWindow Light Startup and Maintenance Tool

DWL Start-Up Assistant

DWL Start-up assistant for DCS800 gives important assistance for commissioning by interactive dialog. The commissioning steps are presented in correct sequence and necessary parameters are preselected.

- The basic port collects basic motor and connection data and executes controller auto tunings
- The advanced port provides assistance for 12-pulse operation, field reversal, serial communication (fieldbus) and master-follower configuration.
- A context-sensitive help function is present during the whole sequence

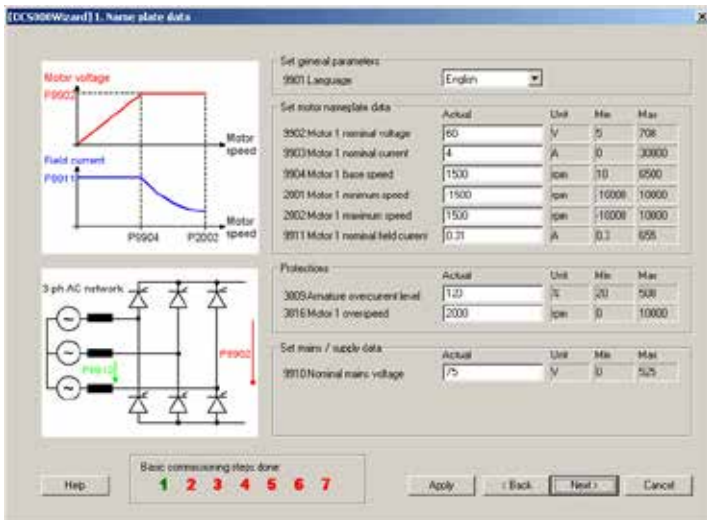

Adaptive Programming (AP) Tool

DWL AP is a graphical PC tool to create, document, edit and download Adaptive Programs. Adaptive Program tools contain 16 function blocks and are available in standard firmware. DWL AP offers a clear and easy way to develop, test and document these programs with a PC.

It is a user-friendly tool to modify function blocks and their connections. No special programming skills are required; basic knowledge about block programming is sufficient.

Adaptive Programs are easy to document as hard copies are stored as PC files. All related information is saved directly to the drive by parameter.

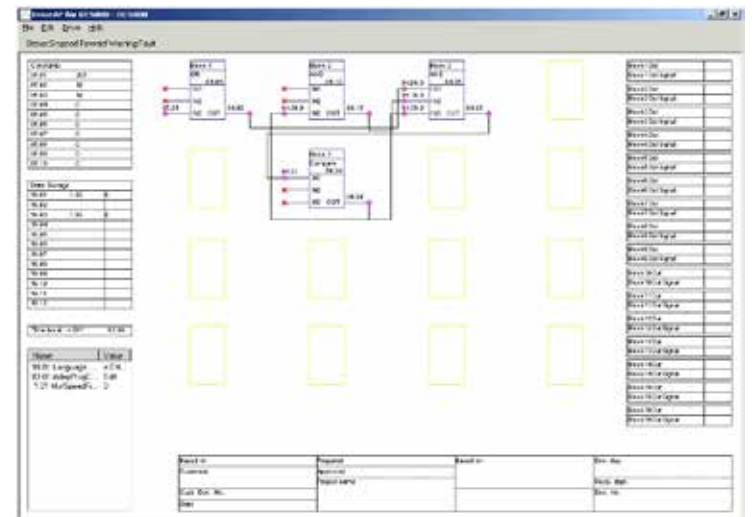

One page is freely configurable by the user. An individual commissioning sequence or parameter selection can be setup to application, machine or motor demands.



Commissioning Macros

DCS800 macros

The DCS800 includes macros that cover the most frequent parameter settings. Macros are pre-programmed parameter subsets. During start-up, the drive can be configured easily without the need to change many individual parameters by using a macro. The functions of inputs, outputs, and many allocations in the control structure are set up with the selection of a macro.

With firmware release 2.6, additional macros were added, bringing the total available to 11 macros. It also allows you to switch between macros with ease. Except for a few special cases, motor and tuning parameters will be maintained when switching from one macro to another.

The macro will define:

- whether the drive is speed-controlled or torque-controlled
- if two-wire (maintained) or three-wire (pulsed) motor-on inputs are being used
- if a DC contactor is being used
- the type of control that is needed (standard, constant speed, hand/motor-pot, etc.)
- the source of the command (digital and analog inputs and outputs or via high-speed-serial link)
- which actual values are available at the analog outputs

The selections include the following macros:

Macro	Description
Factory	Resets all parameters to default values.
Standard	The Drive turns on with a maintained input. Motion is commanded with digital inputs (DI) RUN, JOG1, or JOG2. Run speed is set with an analog input. Jog speeds are set to preset levels.
Manual / Constant Speed	Run speed is set with an analog input, but if one of two digital inputs is set, speed is changed to preset levels. Control is by way of 3-wire control (pulsed inputs).
Hand / Auto	A digital input switches between Hand (Local I/O) and Auto mode, and also switches speed reference. In Hand mode, speed is set with an analog input; in Auto mode, speed and motor control are set over a high-speed serial link, usually by a PLC. Manual control is 2-wire.
Hand / Motor Pot	A digital input switches speed reference from an analog input to Motor Pot. In Motor Pot mode, one digital input (MOTOR POT UP) increases speed and another (MOTOR POT DOWN) decreases speed. Control is 3-wire.
Motor Pot	Speed is always controlled through the MOTOR POT -UP and -DOWN digital inputs. Motor pot minimum speed can be released by setting a digital input to allow MOTOR POT DOWN to reduce speed to zero. Control is 2-wire.
Torque Control	A digital input switches between Speed and Torque control mode. While in Torque mode, an analog input is used as reference; while in Speed mode, speed is set to a preset level. A digital output can control a DC circuit breaker. Control is 2-wire.
Torque Limit	This macro is the same as “Standard,” except a second analog input determines torque limit.
3-Wire Standard	Run speed is set with analog input, but if DI-1 is set, speed is changed to preset level. The drive turns on and runs with pulsed RUN digital input. It turns off with clearing of the STOP input. (3-wire control).
2-Wire DC Contactor US	This macro is the same as “Standard” except it also sets up the drive to control a DC contactor with a digital output. A DC contactor acknowledge input is required.
3-Wire DC Contactor US	This macro is the same as “3-Wire Standard” except it also sets up the drive to control a DC contactor with a digital output. A DC contactor acknowledge input is required.
User 1 and 2	The user is allowed to record the current set of parameters as one of two “User Macros” and restore the drive to one of these sets. Restoration is done by setting or clearing a digital input or by sending a signal over a high-speed serial link. This is handy if, for example, the machine setup changes (i.e., making snow throwers half the season, and lawn mowers the other half) or if changing a drive from being a master to being a follower, etc.
3-Wire Jog	For Flexpak3000 replacements. DI5 switches between Manual (AI1) and Auto (AI2) speed reference. Jog input (DI3) initiates motion and reverses with DI4. Control is 3-wire.

DCS800 Firmware

DCS800 Basic Firmware

DCS800 firmware includes the basic function of speed control, armature current, field current and motor voltage. The flexible design for command location enables fieldbus control, master-follower control, control from hardware signals as well as a mixed structure. The design of drive logic enables a drive reaction defined by Profibus standard but can also be configured to adapt classic command structures.

All parameters can be accessed through serial communication or by IEC 61131 or adaptive programming. Eleven macros are pre-defined and two user-macros can be configured by the user.

Functions of Basic Firmware

- Different speed ramp functions
- Speed control
- Torque control
- Armature current control
- Field current control
- Automatic field weakening
- E-stop function according to Profibus standard
- Dual field control
- Mechanical brake control
- DC breaker control
- Programmable digital and analogue outputs
- Master-Follower
- 16 blocks Adaptive Program
- Interface for IEC 61131 programming
- 12-pulse function - parallel, serial, sequential
- 3-phase field exciter operation
- Converter protection (temperature, voltage,...)

Motor protections

- Stall protections
- Thermal motor model
- 2 channel motor temperature measurement PTC or PT100
- Klixon supervision (RDIO-01 Recommended)
- Speed feedback error
- Over speed
- Armature current ripple
- Armature over current
- Minimum field current

Master-Follower Applications

Drives connected in Master-Follower application

When motors run on a common shaft or other belted or mechanical connection, and run with the same speed or torque, use the master/follower configuration.

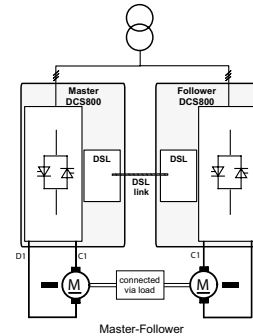

Partial 12-pulse Master-Follower configuration

Under this configuration, converters are fed by a 12-pulse transformer with separated secondary windings whose phase positions differ by 30°. This configuration delivers the same advantages concerning harmonics to the network as a standard 12-pulse application (see next item), but no T-reactor is needed.

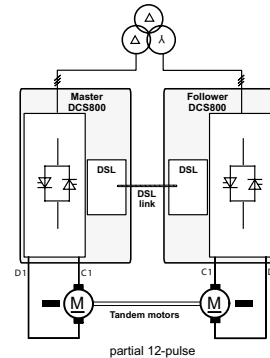

Typical configuration for high power drives connected in 12-pulse parallel, serial or sequential application

12-pulse systems are used to reduce line harmonics or motor noise level, or to increase output current or voltage of the converter system. Only the 11th and 13th, the 23rd and 25th, the 35th etc. are present. The harmonics on the DC side are reduced also, which increases efficiency.

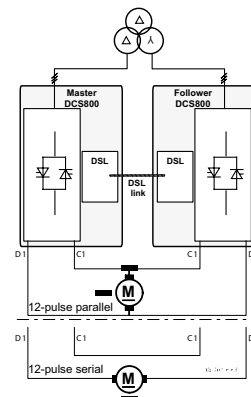

Technical Specifications

System connection	
Voltage, 3-phase	240 to 990 V acc. to IEC 60038
Voltage deviation	±10% continuous; ±15% up to 0.5 sec.
Rated frequency	50 Hz or 60 Hz
Static frequency deviation	50 Hz ±2 %; 60 Hz ±2 %
Dynamic: frequency range	50 Hz: ±5 Hz; 60 Hz: ± 5 Hz
NOTE: Special consideration must be taken for voltage deviation in regenerative mode.	
Short Circuit Current Rating (SCCR)	D1 - D4 = 65 ka D5 - D7 = 100 ka
Protection Class	
Converter module and options (line chokes, fuse holder, field supply unit, etc.)	UL Type Open
Speed Feedback / Accuracy	
Speed resolution	with encoder 0.005% of nominal speed, with analog tach, 0.1% (16 bits)
Cycle time, speed and current controller	2.77 ms at 60 Hz, 3.33 ms at 50 Hz
Step response, current controller	5 ms
Speed feedback	EMF (transducerless), analog tach, encoder, 2nd encoder with RTAC
Analog tach voltage	±8-30 Vdc, ±30-90 Vdc, ±90-270 Vdc
Pulse encoder voltage	5, 12, 15, 24 Vdc
Environmental limit values	
Permissible cooling air temperature.	
- at converter module air inlet	0 to +55°C
with rated DC current	0 to +40°C
with different DC current	+40 to +55°C derating (1%/1°C)
- Options	0 to +40°C
Relative humidity (at 5...+40°C)	5 to 95%, no condensation
Relative humidity (at 0...+5°C)	5 to 50%, no condensation
Change of the ambient temperature	< 0.5°C / minute
Storage temperature	-40 to +55°C
Transport temperature	-40 to +70°C
Pollution degree (IEC 60664-1, IEC 60439-1)	2
Site elevation	
<1000 m above M.S.L.	100%, without derating
1000 to 4000 M.S.L.	with derating (1%/100m)

Sound pressure level

Size	Sound pressure level L _p (1 m distance)		Vibration as module
	as module	enclosed conv.	
D1	55 dBA	54 dBA	1.5 mm, 2...9 Hz 0.5 g, 9...200 Hz
D2	55 dBA	55 dBA	
D3	60 dBA	73 dBA	
D4	66 - 70 dBA	77 dBA	1 mm, 2...9 Hz 0.1 g, 9...200 Hz
D5	73 dBA	78 dBA	
D6	75 dBA	73 dBA	
D7	82 dBA	80 dBA	

North American Standards

In North America the system components fulfil the requirements of the table below.

Rated supply voltage	Standards	
	Converter module	Enclosed converter
to 600 V	UL 508 C Power Conversion Equipment cULus C 22.2 No. 14-95 Industrial Control Equipment, Industrial Products Available for converter modules including field exciter units. Types with UL mark: • see UL Listing www.ul.com/ / certificate no. E196914 • or on request	Enclosed converter cabinets are not UL listed
>600 V to 1000 V	EN / IEC: see table below. Available for converter modules including field exciter units.	EN / IEC types: on request (for details see table below)

Regulatory compliance

The converter module and enclosed converter components are designed for use in industrial environments. In EEA countries, the components fulfill the requirements of the EU directives, see table below.

European union directive	Manufacturer's assurance	Harmonized standards	
		Converter module	Enclosed converter
Machinery Directive			
98/37/EEC 93/68/EEC	Declaration of Incorporation	EN 60204-1 [IEC 60204-1]	EN 60204-1 [IEC 60204-1]
Low Voltage Directive			
73/23/EEC 93/68/EEC	Declaration of Conformity	EN 60146-1-1 [IEC 60146-1-1] EN 61800-5-1 (EN 50178 [IEC--]) see additional IEC 60664	EN 60204-1 [IEC 60204-1] EN 61800-5-1 [IEC 60439-1] [IEC 60439-1]
EMC Directive			
89/336/EEC 93/68/EEC	Declaration of Conformity (Provided that all installation instructions concerning cable selection, cabling and EMC filters or dedicated transformer are followed.)	EN 61800-3 ① [IEC 61800-3] ① in accordance with 3ADW 000 032	EN 61800-3 ① [IEC 61800-3] ① in accordance with 3ADW 000 032/3ADW 000 091

Current Ratings - Modules

Non-Regenerative

Type code Non-regenerative	Frame Size	Input RMS Current A _{rms}	Normal Duty		Standard Duty		Heavy Duty		Internal field current A	Air Flow 60 Hz ft ³ /min	Heat Dissipation BTU/hr
			I _{2Nd} A _{dc}	P _{2Nd} HP	I _{2Sd} A _{dc}	P _{2Sd} HP	I _{2Hd} A _{dc}	P _{2Hd} HP			
500 Vdc											
DCS800-S01-0020-05		16	19	10	18	10	18	10		nonvent.	375
DCS800-S01-0045-05		37	42	25	38	20	38	20		210	580
DCS800-S01-0065-05	D1	53	61	30	54	30	54	30	6A	210	751
DCS800-S01-0090-05		73	88	50	78	40	78	40		210	955
DCS800-S01-0125-05		102	124	75	111	60	104	60		210	1297
DCS800-S01-0180-05	D2	147	171	100	164	100	148	75	15A	210	1911
DCS800-S01-0230-05		188	219	125	205	125	205	125		210	2491
DCS800-S01-0315-05		257	300	150	264	150	264	150		210	3105
DCS800-S01-0405-05	D3	330	385	200	325	200	325	200	20A	420	3822
DCS800-S01-0470-05		384	447	250	405	250	405	250		420	4504
DCS800-S01-0610-05+S171		498	580	300	484	300	490	300		610	6005
DCS800-S01-0740-05+S171	D4	604	704	400	670	400	664	400	25A	610	7302
DCS800-S01-0900-05+S171		734	865	500	795	500	795	500		1160	9145
DCS800-S01-1200-05+S164		979	1105	700	950	600	851	550		500	17402
DCS800-S01-1500-05+S164	D5	1224	1450	900	1320	800	1280	800	25A	500	18084
DCS800-S01-2000-05+S164		1632	1904	1100	1480	900	1479	900		500	22520
DCS800-S01-2050-05		1673	1985	1250	1585	1000	1585	1000		940	27297
DCS800-S01-2500-05	D6	2040	2395	1500	1986	1250	1990	1250	External	940	30709
DCS800-S01-3000-05		2448	2820	1750	2416	1500	2416	1500		940	37875
DCS800-S01-3300-05		2693	3178	2000	2416	1500	2416	1500		2500	39922
DCS800-S01-4000-05	D7	3264	3690	2250	2890	1750	2897	1750	External	2500	44358
DCS800-S01-5200-05		4243	4820	3000	3972	2500	3800	2250		2500	64831
600 Vdc											
DCS800-S01-0290-06	D3	237	280	200	268	200	268	200	External	210	3105
DCS800-S01-0590-06+S171	D4	481	561	400	480	300	470	300	External	610	6347
DCS800-S01-0900-06		734	828	600	665	500	665	500		500	17402
DCS800-S01-1500-06	D5	1224	1428	1000	1325	1000	1325	1000	External	500	21496
DCS800-S01-2000-06		1632	1850	1250	1490	1100	1479	1100		500	27638
DCS800-S01-2050-06		1673	1850	1250	1490	1100	1479	1100		940	31392
DCS800-S01-2500-06	D6	2040	2380	1750	1990	1500	1990	1500	External	940	34804
DCS800-S01-3000-06		2448	2790	2000	2380	1750	2380	1750		940	41628
DCS800-S01-3300-06		2693	3035	2250	2380	1750	2380	1750		2500	44699
DCS800-S01-4000-06	D7	3264	3720	2500	2970	2250	2970	2250	External	2500	51523
DCS800-S01-4800-06		3917	4410	3250	3507	2500	3507	2500		2500	66537
700 Vdc											
DCS800-S01-0900-07		734	820	700	620	500	620	500		500	17402
DCS800-S01-1500-07	D5	1224	1428	1250	1160	1000	1160	1000	External	500	21496
DCS800-S01-2000-07		1632	1850	1500	1490	1250	1479	1250		500	27638
DCS800-S01-2050-07		1673	1850	1500	1490	1250	1479	1250		940	31392
DCS800-S01-2500-07	D6	2040	2380	2000	1990	1750	1990	1750	External	940	34804
DCS800-S01-3000-07		2448	2790	2500	2380	2000	2380	2000		940	41628
DCS800-S01-3300-07		2693	3035	2500	2380	2000	2380	2000		2500	44669
DCS800-S01-4000-07	D7	3264	3720	3250	2970	2500	2970	2500	External	2500	51523
DCS800-S01-4800-07		3917	4480	4000	3507	3000	3507	3000		2500	66537

360 - 800 Vdc line voltage DATA AVAILABLE UPON REQUEST

450 - 990 Vdc line voltage DATA AVAILABLE UPON REQUEST

540 - 1200 Vdc line voltage DATA AVAILABLE UPON REQUEST

Current Ratings - Modules Regenerative

Type code Regenerative	Frame Size	Input RMS Current A _{rms}	Normal Duty			Standard Duty		Heavy Duty		Internal field current A	Air Flow 60 Hz ft ³ /min	Heat Dissipation BTU/hr
			I _{2Nd} A _{dc}	P _{2Nd} HP	I _{2Sd} A _{dc}	P _{2Sd} HP	I _{2Hd} A _{dc}	P _{2Hd} HP				
500 Vdc												
DCS800-S02-0025-05		20	23	10	20	10	20	10			nonvent.	375
DCS800-S02-0050-05		41	47	25	38	20	38	20			210	580
DCS800-S02-0075-05	D1	61	71	40	54	30	54	30	6A		210	751
DCS800-S02-0100-05		82	95	50	84	50	79	40			210	955
DCS800-S02-0140-05		114	133	75	125	75	110	60			210	1297
DCS800-S02-0200-05	D2	163	190	100	166	100	166	100	15A		210	1911
DCS800-S02-0260-05		212	247	150	208	125	208	125			210	2491
DCS800-S02-0350-05		286	333	200	287	150	264	150			210	3105
DCS800-S02-0450-05	D3	367	428	250	360	200	357	200	20A		420	3822
DCS800-S02-0520-05		424	489	300	405	250	405	250			420	4504
DCS800-S02-0680-05+S171		506	647	400	605	300	544	300			610	6005
DCS800-S02-0820-05+S171	D4	669	806	500	740	400	664	400	25A		610	7302
DCS800-S02-1000-05+S171		816	965	600	815	500	810	500			1160	9145
DCS800-S02-1200-05+S164		979	1105	700	950	600	851	500			500	17402
DCS800-S02-1500-05+S164	D5	1224	1450	900	1320	800	1280	800	25A		500	18084
DCS800-S02-2000-05+S164		1632	1885	1100	1490	900	1479	900			500	22520
DCS800-S02-2050-05		1673	1985	1250	1585	1000	1585	1000			940	27297
DCS800-S02-2500-05	D6	2040	2395	1500	1995	1250	1990	1250	External		940	30709
DCS800-S02-3000-05		2448	2820	1750	2382	1500	2382	1500			940	37875
DCS800-S02-3300-05		2693	3178	2000	2416	1500	2416	1500			2500	39922
DCS800-S02-4000-05	D7	3264	3690	2250	2890	1750	2890	1750	External		2500	44358
DCS800-S02-5200-05		4243	4820	3000	3972	2500	3800	2250			2500	64831
600 Vdc												
DCS800-S02-0320-06	D3	261	295	200	268	200	268	200	External		210	3105
DCS800-S02-0650-06+S171	D4	530	619	400	540	400	540	400	External		610	6347
DCS800-S02-0900-06		734	828	600	665	500	665	500			500	17402
DCS800-S02-1500-06	D5	1224	1428	1000	1325	1000	1325	1000	External		500	21496
DCS800-S02-2050-06		1673	1850	1250	1490	1100	1490	1100			940	31392
DCS800-S02-2500-06	D6	2040	2380	1750	1980	1500	1980	1500	External		940	34804
DCS800-S02-3000-06		2448	2790	2000	2293	1750	2293	1750			940	41628
DCS800-S02-3300-06		2693	3035	2250	2370	1750	2370	1750			2500	44699
DCS800-S02-4000-06	D7	3264	3720	2500	2970	2250	2970	2250	External		2500	51523
DCS800-S02-4800-06		3917	4410	3250	3507	2500	3507	2500			2500	66537
700 Vdc												
DCS800-S02-0900-07		734	820	700	620	500	620	500			500	17402
DCS800-S02-1500-07	D5	1224	1428	1250	1160	1000	1160	1000	External		500	21496
DCS800-S02-2050-07		1673	1850	1500	1490	1250	1490	1250			940	31392
DCS800-S02-2500-07	D6	2040	2380	2000	1990	1750	1983	1750	External		940	34804
DCS800-S02-3000-07		2448	2790	2500	2280	2000	2275	2000			940	41628
DCS800-S02-3300-07		2693	3035	2500	2380	2000	2380	2000			2500	44699
DCS800-S02-4000-07	D7	3264	3720	3250	2970	2500	2965	2500	External		2500	51523
DCS800-S02-4800-07		3917	4480	4000	3507	3000	3507	3000			2500	66537

360 - 800 Vdc line voltage DATA AVAILABLE UPON REQUEST

450 - 990 Vdc line voltage DATA AVAILABLE UPON REQUEST

540 - 1200 Vdc line voltage DATA AVAILABLE UPON REQUEST

Note: Normal Duty: 110% overload for 60 seconds; then <= 100% for 10 minutes
Standard Duty: 150% overload for 30 seconds; then <= 100% for 15 minutes
Heavy Duty: 150% overload for 60 seconds; then <= 100% for 15 minutes

Current Ratings - Modules

DCS800-EP Panel Drive

Type code	Panel Size	Frame Size	Heavy Duty 460Vac / 500Vdc			Heavy Duty 230Vac / 240Vdc			Internal field current A	Air Flow 60 Hz ft ³ /min	Heat Loss without Inductor Watts	Heat Loss with Inductor Watts
			Input	I _{2HD}	P _{2HD}	Input	I _{2HD}	P _{2HD}				
			A _{rms}	A _{dc}	HP	A _{rms}	A _{dc}	HP				

Non-regenerative

DCS800-EP1-0020-05	A	D1	14	17	10	16	20	5	6	nonvent.	162	182
DCS800-EP1-0045-05	A	D1	29	35	20	30	37	10	6	210	228	283
DCS800-EP1-0065-05	A	D1	43	53	30	44	54	15	6	210	291	350
DCS800-EP1-0090-05	A	D1	55	68	40	58	71	20	6	210	356	426
DCS800-EP1-0125-05	A	D1	85	104	60	85	104	30	6	210	483	578
DCS800-EP1-0180-05	B	D2	102	125	75	102	125	30	15	210	656	751
DCS800-EP1-0230-05	B	D2	167	205	125	168	206	60	15	210	882	1017
DCS800-EP1-0315-05	B	D3	200	245	150	208	255	75	20	210	1074	1209
DCS800-EP1-0405-05	C	D3	265	325	200	278	341	100	20	420	1326	-
DCS800-EP1-0470-05	C	D3	330	405	250	347	425	125	20	420	1551	-
DCS800-EP1-0610-05	C	D4	392	480	300	413	506	150	25	610	1996	-
DCS800-EP1-0740-05	D	D4	522	640	400	-	-	-	25	610	2334	-
DCS800-EP1-0900-05	D	D4	649	795	500	-	-	-	25	1160	2982	-

Regenerative

DCS800-EP2-0025-05	A	D1	14	17	10	16	20	5	6	nonvent.	170	190
DCS800-EP2-0050-05	A	D1	29	35	20	30	37	10	6	210	246	301
DCS800-EP2-0075-05	A	D1	43	53	30	44	54	15	6	210	319	378
DCS800-EP2-0100-05	A	D1	55	68	40	58	71	20	6	210	387	457
DCS800-EP2-0140-05	A	D1	85	104	60	85	104	30	6	210	530	625
DCS800-EP2-0200-05	B	D2	134	164	100	143	175	50	15	210	776	903
DCS800-EP2-0260-05	B	D2	167	205	125	168	206	60	15	210	960	1095
DCS800-EP2-0350-05	B	D3	200	245	150	208	255	75	20	210	1168	1303
DCS800-EP2-0450-05	C	D3	265	325	200	278	341	100	20	420	1465	-
DCS800-EP2-0520-05	C	D3	330	405	250	347	425	125	20	420	1695	-
DCS800-EP2-0680-05	C	D4	392	480	300	413	506	150	25	610	2167	-
DCS800-EP2-0820-05	D	D4	522	640	400	-	-	-	25	610	2552	-
DCS800-EP2-1000-05	D	D4	649	795	500	-	-	-	25	1160	3252	-
DCS800-EP2-1010-05*	D	D4	775	950	600	-	-	-	25	1160	3305	-

*All DCS800-EP panel drives have a heavy duty rating except DCS800-EP2-1010-05 which has a normal duty rating

Environmental Conditions and Specifications

DCS800-EP Panel Drive

Environmental limit values	
Input Voltage	3-Phase 460 Vac (230 Vac as option)
Environmental limit values	
Cabinet internal ambient temperature	0 to 40°C
Protection Class	UL Type Open / IP00
Environmental limit values	
cULus Listed	UL 508A with 65 kA SCCR

See module conditions and specifications for additional data

Dimensions and Weights

Dimensions and Weights - Module Drive

Unit Size	Power Connection		Weight (lbs)	Dimensions	
	In	Out		h x w x d (in)	h x w x d In Out (mm)
D1	Bottom	Bottom	24	14.6 x 10.6 x 7.9	370 x 270 x 200
D2	Bottom	Bottom	35	14.6 x 10.6 x 10.6	370 x 270 x 270
D3	Bottom	Bottom	55	18.1 x 10.6 x 12.2	459 x 270 x 310
D4	Bottom	Bottom	84	25.4 x 10.6 x 13.6	644 x 270 x 345
D5	Top	Bottom	242	39.6 x 20.1 x 16.1	1005 x 510 x 410
D6	Left	Left	396	69.0 x 18.1 x 16.1	1750 x 460 x 410
D7*	Left or Right (as selected in the type code)		693	69.0 x 30.0 x 22.4	1750 x 760 x 570

*Largest D7 rating in each voltage class has separately mounted control section with dimensions same as a D1 unit.



Dimensions and Weights - Panel Drive

Panel Size	Drive Size	Power Connection		Weight (lbs)	Dimensions	
		In	Out		h x w x d (in)	h x w x d In Out (mm)
A	D1	Top	Top	62	18.8 x 12.2 x 14.4	478 x 309 x 366
B	D2	Top	Top	103	19.3 x 20.0 x 13.8*	490 x 508 x 351
B	D3	Top	Top	130	19.3 x 20.0 x 13.8*	490 x 508 x 351
C	D3	Top	Top	231	35.3 x 23.6 x 16.2	897 x 599 x 411
C	D4	Top	Top	260	35.3 x 23.6 x 16.2	897 x 599 x 411
D	D4	Top	Top		45.7 x 26.7 x 16.0**	1160 x 678 x 406

*19.3 inch (490 mm) depth when internal reactor option is included.

**19.7 in (499 mm) depth when circuit breaker option is included.

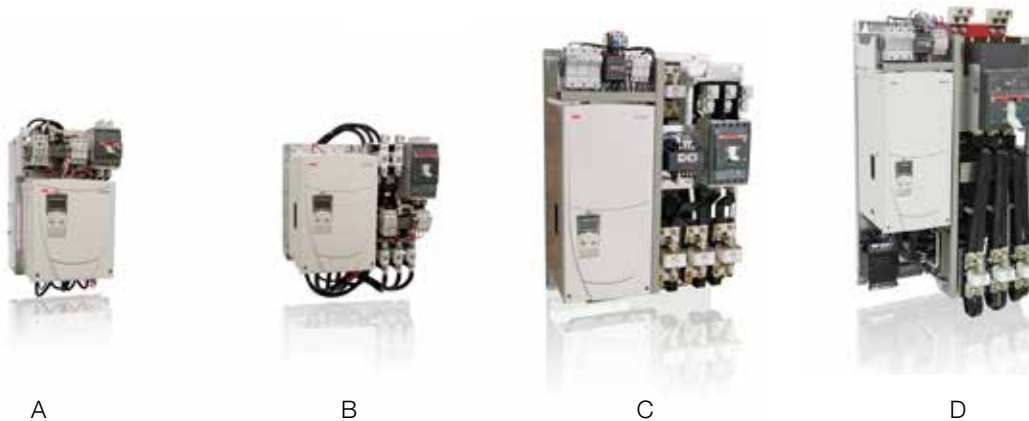

Technical Diagram

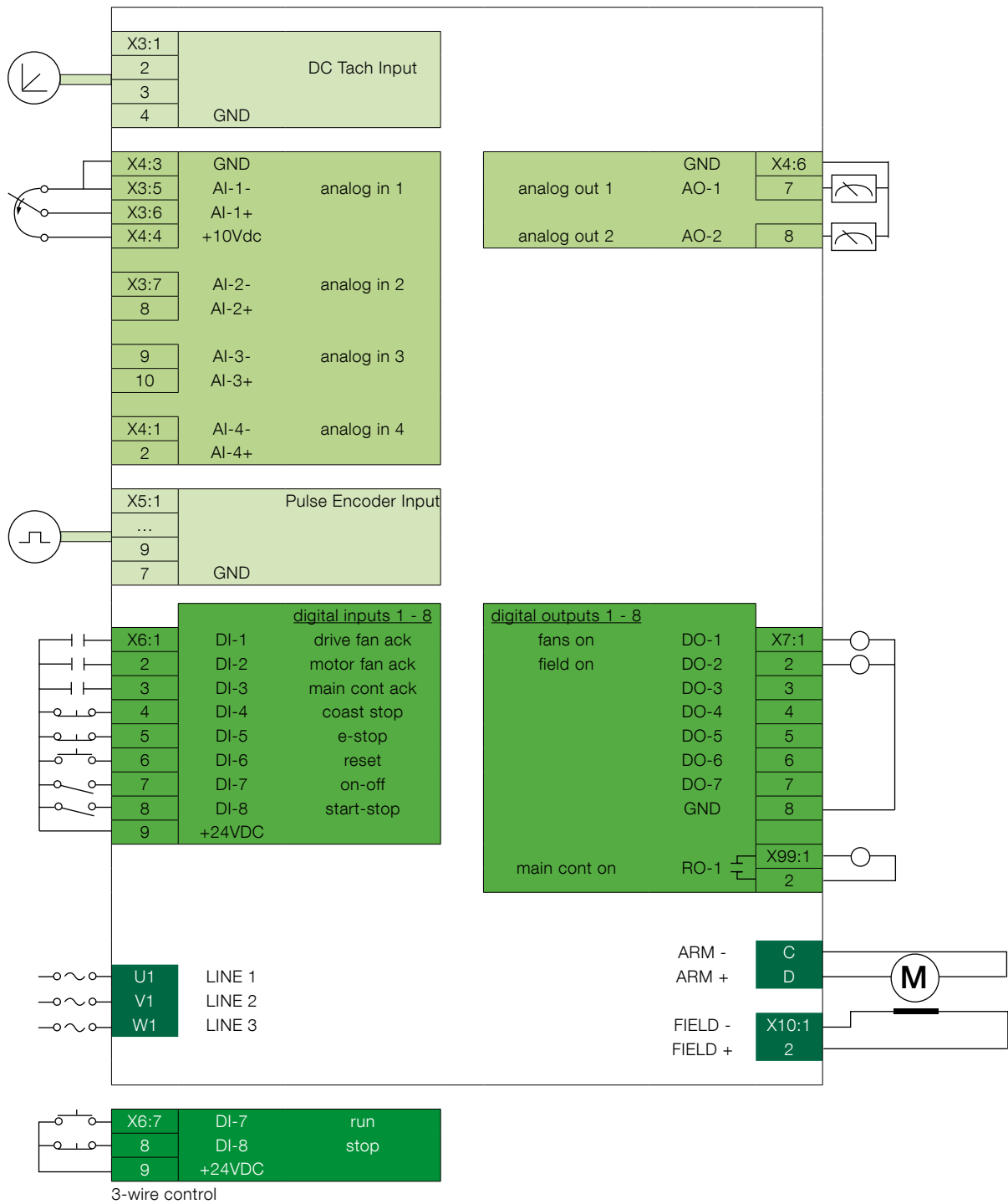

- **Digital Inputs and Outputs** can be freely configured by the user. This diagram shows the default settings with 2-wire control (maintained inputs). The drive can optionally be configured to accept 3-wire control (pulsed inputs).
- **RDIO-01 Digital Extension Module** adds three isolated (3) digital inputs and two (2) relay outputs. Up to two can be added providing a maximum of 14 digital inputs and 12 digital outputs.
- **RAIO-01 Analog Extension Module** adds two (2) current/voltage analog inputs and two (2) current analog outputs. One can be added providing a maximum of six (6) analog inputs and four (4) analog outputs.

Plug-in Options

1. Basic Control Panel

The DCS800 alphanumeric control panel is standard with every drive. It features a 5-line display and two soft keys. The panel is used to commission and control the drive. Parameters can be saved to it for backup or to download to another drive.

Plus code

- +0J400 If no control panel is required
- J409 Panel mounting kit ACS/H-CP-EXT plus cable

2. Plug-in Fieldbus Module

See “Fieldbus Control” section

Fast Optical DDCS Communication Module

DCS800 provides an interface SDCS-COM-8 fast serial communication:

- Master channel ModuleBus to AC800M
- I/O channel to AIMA-01 board
- Master-Follower DDCS channel
- Tools channel e.g DriveWindow, remote diagnostic NETA, as well as the CDP 312 from ACS800 range can be connected on this board
- The board must be located in slot3

Plus code

- +L508 Module bus 10 Mbd (SDCS-COM-81)
- +L509 NxxA fieldbus adapter 5 Mbd (SDCS-COM-82)

3. Drive-Specific Serial Communication Board

The SDCS-DSL board provides the serial communication for:

- Drive to drive (e.g. master-follower)
- Drive to external field power supply
- 12-pulse applications

Plus code

- +S199 SDCS-DSL communication board

4. Field Power Supply

Sizes D1 through D4 drives have an internal field power supply. On Size D5, the field power supply is optional. Sizes D6 – D7 require an external field power supply.

Plus code

- +S164 Internal field supply, not prewired (D5)

5. Control Builder

To include Control Builder with the drive, the compact flash memory card must be ordered with a plus code. CoDeSys software for the PC is ordered separately.

Plus code

- +S200 Compact flash memory card (SDCS-MEM-8)

6. I/O Extension Option Module

This plug-in option offers additional analog or digital I/O. They can be used, for example, in a Master-Follower application for interlocking functions. All the relays can be programmed to on off by parameter. Alternatively, a fieldbus module can be used to control any external components in the system. I/O extension modules can be located in any of the three available option slots.

Plus code

- +L501 RDIO-01 Digital extension module 3xDI, 2xDO
- +L500 RAIO-01 Analog extension module 2xAI, 2xAO



Feedback Options

Feedback Options

The DCS800 can be configured to work with a variety of feedback options to monitor motor and line speed. Together with the standard interface, the drive can read up to one tachometer and two encoders simultaneously. Resolvers can be used in place of encoders. “Encoderless” operation, using motor EMF as feedback, is also possible and an excellent choice in many applications.

Tachometer

The drive has a tachometer interface as standard for tachometers with maximum voltages of 8 to 270 Vdc. For AC tachometers with rectifiers, the drive has a filter to smooth out the signal going to the drive.

Pulse Encoders

The drive also has one encoder interface as standard, to operate with single-ended and differential pulse encoders. The non-isolated interface works with 5Vdc and 24Vdc devices, and also 12Vdc devices for drives over 1000 Amps (D5 and over).

A second pulse encoder interface (non-isolated) can be used with the addition of one of the RTAC pulse encoder interface adapters. The RTAC-03 is used for TTL encoders; the RTAC-01 is used for other types. To add an isolated pulse encoder interface, the IOB-03 can be used. The IOB-03 is separately mounted on DIN rail.

- +L517 5 & 24 Vdc TTL encoder interface (RTAC-03)
- +L502 15 & 24 Vdc encoder interface (RTAC-01)

Resolvers

Two options are available for resolver interface. The first option is for applications where the resolver is primarily used as a positioning device, a lifting table, for example. In this case, the RRIA-01 resolver interface adapter can be used. The RSCM-01 can also be used to double the resolver voltage to adapt it to the working range of RRIA-01.

- +L516 Resolver interface adapter (RRIA-01)
- Resolver signal conditioning mod. (RSCM-01)

When speed control is required, or whenever a premium interface is desired, the FEN-21 resolver interface adapter should be used. The FEN-21 provides an ultra-smooth speed feedback signal for optimal speed control. The FEN-21 is mounted to a DIN-rail extension adapter (FEA-01) which converts the feedback to a fiber optic signal and transmits it to the drive's COM-81 or COM-82 module. (Fiber optic cable and external 24Vdc supply also required.)

- +L508 Fiber optic - standard (COM-81)
- +L509 Fiber optic - NETA (COM-82)
- external F-type resolver (FEN-21)
- external F-type resolver (FEA-01)



FEN-21 resolver interface module mounted on a FEA-01 F-series extension adapter.

Communication Options

Fieldbus Control

DCS800 DC Drives have connectivity to major automation systems. This is achieved with a dedicated gateway concept between the fieldbus systems and ABB drives.

The fieldbus gateway module can easily be mounted inside the drive. As a result of the wide range of fieldbus gateways, your choice of automation system is independent from your decision to use first-class ABB drives.

Manufacturing flexibility

Drive control

The drive control word (16 bit) provides a wide variety of functions from start, stop and reset to ramp generator control. Typical setpoint values like speed, torque and position can be transmitted to the drive with 15 bit accuracy.

Drive monitoring

A set of drive parameters and/or actual signals, like torque, speed, position, current etc., can be selected for cyclic data transfer providing fast data for operators and the manufacturing process.

Drive diagnostics

Accurate and reliable diagnostic information can be obtained via the drive alarm, limit and fault words, reducing the drive down time and, therefore, the downtime of the manufacturing process.

Drive parameter handling

Total integration of the drives in the production process is achieved by single parameter read/write up to complete parameter set-up or download.

Easy to expand

Serial communication simplifies the latest trend of modular machine design enabling the installation to be expanded at a later stage with low effort.

Reduced installation and engineering effort

Cabling

Substituting the large amount of conventional drive control cabling with a single twisted pair reduces costs and increases system reliability.

Design

The use of fieldbus control reduces engineering time at installation because of the modular structure of the hardware and software.

Commissioning and assembly

The modular machine configuration allows pre-commissioning of single machine sections and provides easy and fast assembly of the complete installation.

Currently available gateways

Gateway	Plus Code
Profibus-DP	+K454
DeviceNet	+K451
CANopen	+K457
ControlNet	+K462
Modbus RTU	+K458
Ethernet/IP, Modbus TCP	+K466



External Field Supply

General Data

- Currents from 0.3 to 520 A
- Minimum field current monitor
- Integrated external field power converter or completely separate switchgear cubicle
- Single-phase or 3-phase model
- Controlled by serial communication via DSL board

The three-phase field power converter causes less voltage stress on the motor over the single-phase field converter. This is because rectifying three-phase power provides a smoother DC voltage.

For single-phase operation, we recommend integrating an auto transformer in the field power converter's supply circuit to adjust the AC input voltage to the field voltage and to reduce the voltage ripple in the field circuit.

All field converters are controlled by the armature converter via a serial interface (SDCS-DSL board). This interface serves to set-up, control and diagnose the field converter and thus provides an option for exact control.

Reactor for Field supply on the D5 Drive:

The D5 drive with plus code +S164 has internal field supply FEX425-INT. This field supply should be separately powered and requires its own line reactor as identified below.

Field Converter Types

DCF803-0035 and FEX425

- Three-phase or single-phase operation
- Half-wave thyristor/diode bridge
- Microprocessor control, with the electronic system being supplied by the armature-circuit converter (24 V)
- Construction and components have been designed for an insulation voltage of 600 Vac
- Fast-response excitation is possible with an appropriate voltage reserve; de-excitation takes place by field time constant
- Output voltage U_A (single-phase operation)

$$U_A \leq U_V * \left(\frac{100\% + TOL}{100\%} \right) * 0.9$$

TOL = tolerance of line voltage in %

U_V = Line voltage

Recommendation (single-phase operation):

- Field voltage 0.6 to 0.8 * U_V
- Output voltage U_A (three-phase operation):

$$U_A \leq U_V * \left(\frac{100\% + TOL}{100\%} \right) * 1.35$$

TOL = tolerance of line voltage in %

U_V = Line voltage

Note: Calculation valid also for FEX425 (internal supply for D5 frame)

Table of field converter units

Unit type	Output current I_{DC}	AC field supply voltage	Auxiliary supply voltage	Comments
DCF803-0016 DCF803-0035	0.3 to 16A 0.3 to 35A	110V -15% to 500V**/1-ph +10% single-phase or three-phase	24 V DC 200 mA	Line reactor required: - for 3 phase operation use KLR16BTB, KLR45CTB - for 1 phase, use ND-30 DCF803-0035 needs external fusing
FEX425-INT	0.3 to 25A			
DCF503B-0050 DCF503B-0060	0.3 to 50A 0.3 to 60A	110V -15% to 500V**/1-ph +10%	115 or 230 V	if necessary via matching autotransformer; fuse external; Dimensions HxWxD: 370x125x342 [mm] Requires DCS800-DSL communications cable
DCF504B-0050 DCF504B-0060	0.3 to 50A 0.3 to 60A	110V -15% to 500V**/1-ph +10%		
DCS800-S0x-xxxx-05	25 to 520 A	200V. to 500V**/3-ph		

Notes:

* Up to 600 Vac with auto transformer

** Up to 690 Vac with auto transformer

External Field Supply

DCF503B-0050, DCF503B-0060

- Single-phase operation
- Half-wave thyristor/diode bridge (1-Q)
- Built-in line chokes
- Microprocessor control with the control electronics being supplied separately (115...230 V/1-ph)
- Construction and components have been designed for an insulation voltage of 690 VAC.
- Output voltage U_A

$$U_A \leq U_V * \left(\frac{100\% + TOL}{100\%} \right) * 0.9$$

TOL = tolerance of line voltage in %

UV = Line voltage

Recommendation:

- Field voltage 0.6 to 0.8 * U_V
- Requires DCS800-DSL communications cable

DCF504B-0050, DCF504B-0060

- Single-phase operation
- Full-wave regenerative thyristor bridges (4-Q)
- Built-in line chokes
- This unit offers field reversal as well as fast-response excitation / de-excitation. In the steady-state condition, the full-wave bridge runs in half-wave mode so as to keep the voltage ripple at a minimum. With a quickly alternating field current, the bridge switches to full-wave mode.
- Same design as DCF503B
- Requires DCS800-DSL communications cable

External Field Supply AC Line Fuses

Field Supply	I_{field}	Fuse Single Phase	Fuse Three Phase
DCF503B-0060 DCF504B-0060	50 - 60 Amps	FWP-70B	-
DCF803-0035, DCF503B-0050 or DCF504B-0050	6 Amps 6 - 12 Amps 12 - 25 Amps 25 - 35 Amps	FWP-10B FWP-15B FWP-25B FWP-50B	FWP-5B FWP-10B FWP-25B FWP-30B
DCF503B-0050 or DCF504B-0050	35 - 50 Amps	FWP-60B	-

DCS800

The DCS800-S0X Drive Module can also be used for field exciter operation. An additional overvoltage protection unit is required. It provides field currents from 25 A up to 520 A unipolar and bipolar for field reversal function.

- Output voltage
 U_A respectively $U_{dmax\ 2-Q}$: see table on page 5

Recommendation:

- Field voltage 0.5 to 1.1 * U_V
- The three-phase field supply converters DCS800- S01/S02 need a separate active overvoltage protection unit DCF 506 for protecting the power part against inadmissibly high voltages.

Assignment of field supply converter to overvoltage protection unit

Field supply converter for motor fields	Overvoltage protection
DCS800-S0x-0020-05	
...	DCF506-0140-51
DCS800-S0x-0140-05	
DCS800-S0x-0200-05	
...	DCF506-0520-51
DCS800-S0x-0520-05	

Fuse Connections

Semiconductor type F1 fuses and fuse holders for AC and DC power lines

AC Line Fuses

The converter units are subdivided into two groups. Frame sizes D1, D2, D3, and D4, with rated currents up to 1000 Amps, require external AC line fuses. Recommendations are shown below. Frame sizes D5, D6, and D7, with rated currents of 900 to 5200 Amps, have semiconductor fuses installed internally. No additional external semiconductor line fuses are needed.

DC Fuses

DC fuses between the drive and the motor are required for regenerative (4-quadrant) converters. This is to protect the drive in the possible event of an inversion fault. When needed, DC fuses should be the same size and type as AC line fuses. DCS800 drives frames D5 – D7 include thyristor branch fuses which can protect the motor during a commutation (inversion) fault but thyristor or motor damage could still result. Use DC fuses or a high speed DC breaker for complete protection, especially for motors that regenerate routinely and on large motor drive systems.

Table of field converter units

Type of Converter		Fuse	Fuse Holder	Fuse	Fuse Holder
2-Q Converter	4-Q Converter	North America		Worldwide	
DCS800-SO1-0020-05	DCS800-SO2-0025-05	FWP-50B	1BS101	170M 1564	OFAX 00 S3L
DCS800-SO1-0045-05	DCS800-SO2-0050-05	FWP-80B	1BS101	170M 1565	OFAX 00 S3L
DCS800-SO1-0065-05	DCS800-SO2-0075-05	FWP-125A	1BS103	170M 1568	OFAX 00 S3L
DCS800-SO1-0090-05	DCS800-SO2-0100-05	FWP-125A	1BS103	170M 1568	OFAX 00 S3L
DCS800-SO1-0125-05	DCS800-SO2-0140-05	FWP-200A	1BS103	170M 3815	OFAX 1 S3
DCS800-SO1-0180-05	DCS800-SO2-0200-05	FWP-250A	1BS103	170M 3816	OFAX 1 S3
DCS800-SO1-0230-05	DCS800-SO2-0260-05	FWP-300A	1BS103	170M 3817	OFAX 1 S3
DCS800-SO1-0315-05	DCS800-SO2-0350-05	FWP-500A	1BS104	170M 5810	OFAX 2 S3
DCS800-SO1-0405-05	DCS800-SO2-0450-05	FWP-700A	See Note 1	170M 6811	OFAX 3 S3
DCS800-SO1-0470-05	DCS800-SO2-0520-05	FWP-700A	See Note 1	170M 6811	OFAX 3 S3
DCS800-SO1-0610-05	DCS800-SO2-0680-05	FWP-900A	See Note 1	170M 6163	3X 170H 3006
DCS800-SO1-0740-05	DCS800-SO2-0820-05	FWP-900A	See Note 1	170M 6163	3X 170H 3006
DCS800-SO1-0900-05	DCS800-SO2-1000-05	FWP-1200A	See Note 1	170M 6166	3X 170H 3006
DCS800-SO1-0290-06	DCS800-SO2-0320-06	FWP-500A	1BS104	170M 5810	OFAX 2 S3
DCS800-SO1-0590-06	DCS800-SO2-0650-06	FWP-900A	See Note 1	170M 6813	OFAX 3 S3

Three (3) fuses and fuse holders are required for the AC side. DC fuses are required for 4-Q converters D1-D4. When needed, use 2 for the DC side.

Note 1: No fuse holder is available. Attach fuses directly to busbar.

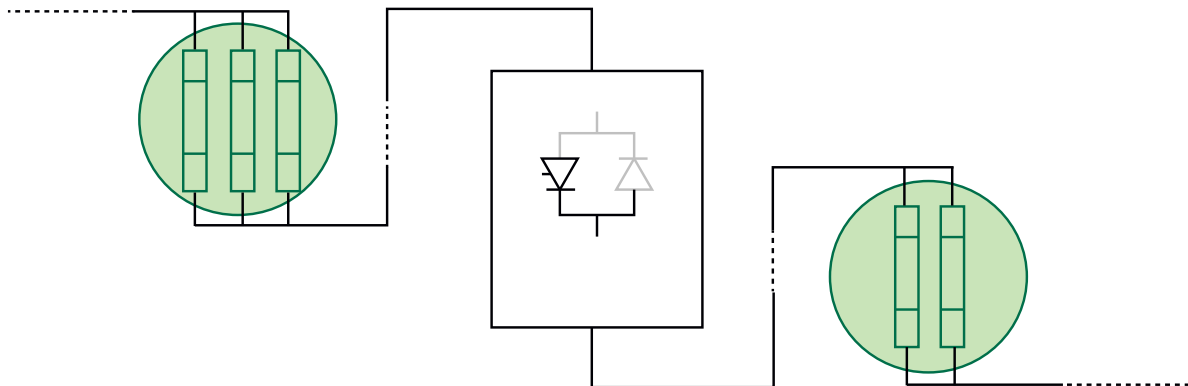

Line reactors

Unit Type		Line Choke for Config. A		Line Choke for Config. B
2Q Converters	4Q Converters	1.5% impedance	3% impedance	5% impedance
500 Vdc				
DCS800-S01-0020-05	DCS800-S02-0025-05	KLR21BTB	LRAC02502	KLR21CTB
DCS800-S01-0045-05	DCS800-S02-0050-05	KLR45BTB	LRAC04502	KLR45CTB
DCS800-S01-0065-05	DCS800-S02-0075-05	KLR80BTB	LRAC08002	KLR80CTB
DCS800-S01-0090-05	DCS800-S02-0100-05	KLR110BCB	LRAC13002	KLR110CCB
DCS800-S01-0125-05	DCS800-S02-0140-05	KLR130BCB	LRAC13002	KLR130CCB
DCS800-S01-0180-05	DCS800-S02-0200-05	KLR200BCB	LRAC20002	KLR200CCB
DCS800-S01-0230-05	--	KLR200BCB	LRAC20002	KLR200CCB
--	DCS800-S02-0260-05	KLR250BCB	LRAC25002	KLR250CCB
DCS800-S01-0315-05	DCS800-S02-0350-05	KLR300BCB	LRAC40002	KLR300CCB
DCS800-S01-0405-05	--	KLR360BCB	LRAC40002	KLR360CCB
DCS800-S01-0470-05	DCS800-S02-0450-05	KLR420BCB	LRAC40002	KLR420CCB
--	DCS800-S02-0520-05	KLR480BCB	LRAC50002	KLR480CCB
DCS800-S01-0610-05	DCS800-S02-0680-05	KLR600BCB	LRAC60002	KLR600CCB
DCS800-S01-0740-05	DCS800-S02-0820-05	KLR750BCB		KLR750CCB
DCS800-S01-0900-05	--	KLR750BCB		KLR750CCB
--	DCS800-S02-1000-05	KLR850BCB		KLR850CCB
DCS800-S01-1200-05	DCS800-S02-1200-05		KDRX3L	KDRX3H
DCS800-S01-1500-05	DCS800-S02-1500-05		KDRY1L	KDRY2H
600 Vdc				
DCS800-S01-0290-06	--	KLR250BCB		KLR250ECB
--	DCS800-S02-0320-06	KLR300BCB		KLR300ECB
DCS800-S01-0590-06	DCS800-S02-0650-06	KLR600BCB		KLR600ECB
DCS800-S01-0900-06	DCS800-S02-0900-06	KLR750BCB		KLR750ECB
DCS800-S01-1500-06	DCS800-S02-1500-06		KDRY41L	KDRY42H

Note:

- 3% reactors beginning with "LRAC" are available from Baldor Electric.
- Configuration A: For most installations
- Configuration B: For installations that require compliance with EN 61-800-3 or when AC and DC drives are on the same line
- See DCS800 hardware manual for additional information

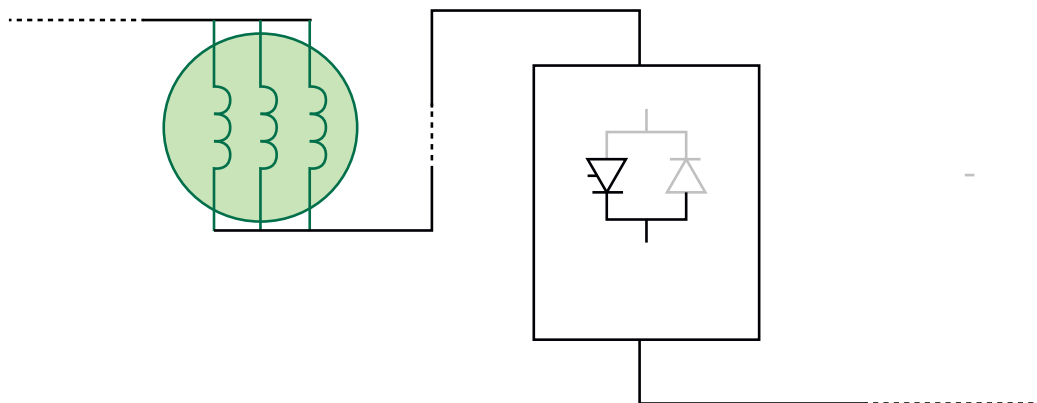

Input and Output Contactors

Unit Type		AC Input Contactors	DC Output Contactors	Dynamic Brake Contactors
2Q Converters	4Q Converters	3-Pole (NO)	2-Pole (NO)	2-NO & 1-NC
500 Vdc				
DCS800-S01-0020-05	DCS800-S02-0025-05	A12-30-11-84	DA75-20-11-84	DA75-21-21-84
DCS800-S01-0045-05	DCS800-S02-0050-05	A30-30-11-84	DA75-20-11-84	DA75-21-21-84
DCS800-S01-0065-05	DCS800-S02-0075-05	A50-30-11-84	EHDB220C2P-1L	EHDB220C-1L
DCS800-S01-0090-05	DCS800-S02-0100-05	A75-30-11-84	EHDB220C2P-1L	EHDB220C-1L
DCS800-S01-0125-05	DCS800-S02-0140-05	A110-30-11-84	EHDB220C2P-1L	EHDB220C-1L
DCS800-S01-0180-05	DCS800-S02-0200-05	A145-30-11-84	EHDB220C2P-1L	EHDB220C-1L
DCS800-S01-0230-05	- -	A210-30-11-84	EHDB280C2P-1L	EHDB280C-1L
- -	DCS800-S02-0260-05	A210-30-11-84	EHDB280C2P-1L	EHDB280C-1L
DCS800-S01-0315-05	DCS800-S02-0350-05	A260-30-11-84	EHDB360C2P-1L	EHDB360C-1L
DCS800-S01-0405-05	- -	AF400-30-11-70	EHDB520C2P-1L	EHDB520C-1L
DCS800-S01-0470-05	DCS800-S02-0450-05	AF400-30-11-70	EHDB520C2P-1L	EHDB520C-1L
- -	DCS800-S02-0520-05	AF400-30-11-70	EHDB520C2P-1L	EHDB520C-1L
DCS800-S01-0610-05	- -	AF580-30-11-70	EHDB650C2P-1L	EHDB650C-1L
- -	DCS800-S02-0680-05	AF580-30-11-70	EHDB800C2P-1L	EHDB800C-1L
DCS800-S01-0740-05	- -	AF750-30-11-70	EHDB800C2P-1L	EHDB800C-1L
- -	DCS800-S02-0820-05	AF750-30-11-70	EHDB960C2P-1L	EHDB960C-1L
DCS800-S01-0900-05	- -	AF1350-30-11-70	EHDB960C2P-1L	EHDB960C-1L
- -	DCS800-S02-1000-05	AF1350-30-11-70	Bar Contactor	Bar Contactor
DCS800-S01-1200-05	DCS800-S02-1200-05	AF1350-30-11-70	Bar Contactor	Bar Contactor
DCS800-S01-1500-05	DCS800-S02-1500-05	AF1650-30-11-70	Bar Contactor	Bar Contactor
600 Vdc				
DCS800-S01-0290-06	DCS800-S02-0320-06	A260-30-11-84	EHDB360C2P-1L	EHDB360C-1L
DCS800-S01-0590-06	DCS800-S02-0650-06	AF460-30-11-70	EHDB680C2P-1L	EHDB680C-1L
DCS800-S01-0900-06	DCS800-S02-0900-06	AF750-30-11-70	EHDB960C2P-1L	EHDB960C-1L
DCS800-S01-1500-06	DCS800-S02-1500-06	AF1650-30-11-70	Bar Contactor	Bar Contactor

AC Input Contactors: Contactors have 120Vac / 50-60Hz coil with 1-NO and 1-NC aux. contact.

DC Output and Dynamic Brake Contactors: Contactors have 120Vac / 60Hz coil with 1-NO and 1-NC aux. contact.

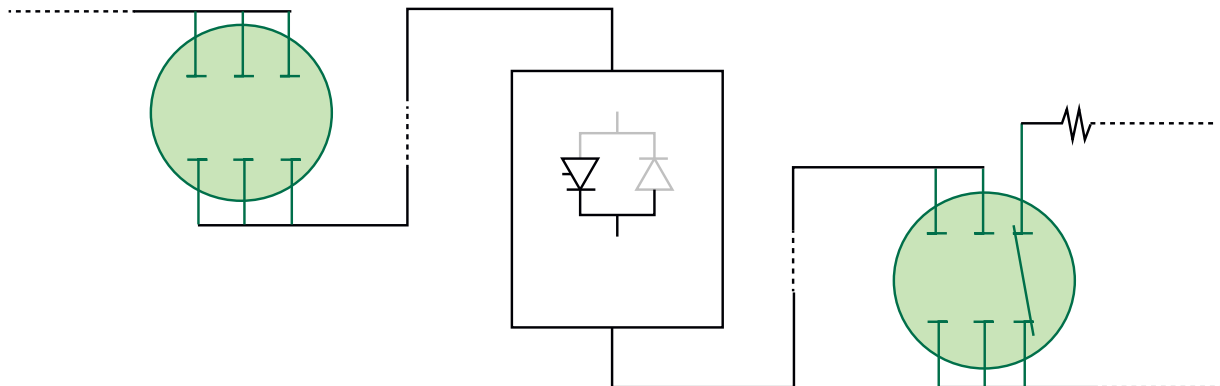

Either an AC or DC contactor is required, but not both.

Control Builder

Programming Tool

Control Builder is an optional, user-friendly tool for programming the DCS800 based on the IEC61131-3 standard. With Control Builder, it is possible to develop application programs directly in the drive quickly and easily, programs that customize the application, decentralize control, add additional interlocks, and much more. Control Builder offers a clear and easy way to develop, test and document your application programs.

Control Builder consists of the following:

- CoDeSys programming software for the PC
- Compact flash memory card
- Expanded library of functions

CoDeSys: a PC software tool for creating, documenting, editing and downloading your custom application program. No special programming skills are required. CoDeSys supports all five programming languages of IEC61131-3. Additionally, a Continuous Function Chart option is included. This makes it possible for you to program the drive in whatever language you are most comfortable with.

Compact flash memory card: The application program is stored on a compact flash memory card (MC) which is plugged into the drive. MC memory is sufficient to store a program made up of hundreds of functions.

Expanded library of functions: More than 100 types of functions are available including strings, timers, counters, and triggers, in addition to math and conversion functions. Various pre-configured functions are also included such as a PID-controller and a winder. User defined functions can also be created and saved.

Upload and Download

Application programs can be uploaded from connected drives and displayed graphically on a PC screen for service and documentation purposes. Online debugging functions include single-step, single-cycle, and breakpoint modes. An event triggered recording tool for variables and signals is also available. Programs made off-line can be downloaded to any of the connected drives that support them.

Three Operating Modes

Control Builder can be used to program the drive in three different ways:

- Standalone mode – CoDeSys is not connected to the drive. The application program can be written in the office and later downloaded to the drive.
- Off-line mode – CoDeSys is connected to the drive. Changes can be made to the application program without any affect on the drive until the program is downloaded.
- On-line mode – CoDeSys is connected to the drive. Changes to the application program are written immediately to the drive and actual values are shown on the screen in real-time.

Advantages and Features

- Easy-to-use tool, no special skills required
- Create and download custom programs
- Automatic documentation
- Can eliminate the need for an external PLC
- The application, including source code, is always part of the drive and thus, can be maintained during the whole life cycle of the machine
- The source code can be password protected against unauthorized access

If 16 or fewer function blocks are required, you may be able to use Adaptive programming instead, which is standard on all DCS800 drives. See page 8.



Start-up, maintenance and integration

DriveWindow

Start-up and Maintenance Tool

ABB's DriveWindow is an advanced, easy-to-use PC software tool for the start-up and maintenance of ABB DCS800 DC Drives. Its host of features and clear, graphical presentation of the operation make it a valuable addition to your system providing information necessary for troubleshooting, maintenance and service, as well as training.

With DriveWindow the user is able to follow the operation of several drives simultaneously by collecting the actual values from the drives onto a single screen or printout.

Additionally, the client part of DriveWindow may reside on one Local Area Network PC, and the server side on another PC closer to the drives. This enables plant-wide monitoring to be easily accomplished with two PCs.

High Speed Communication

DriveWindow uses a high-speed fiber optic cable network with DDCS communication protocol.

This makes communication between PC and drives very fast. The fiber optic network is safe and immune to external disturbance. A fiber optic communication card is needed inside the computer.

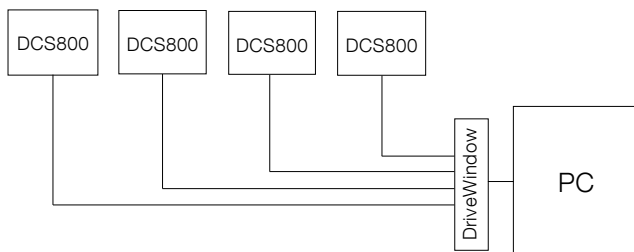

Monitoring Drives

Using DriveWindow you can monitor several drives simultaneously. The history buffer makes it possible to record a large amount of data in the PC's memory. The drive's data logger can be accessed with DriveWindow and viewed in graphical form. The fault logger inside the drive automatically documents every faults, warnings and events that occur. The fault history stored in the drive can be uploaded to your computer.

Versatile Back-Up Functions

Drive parameters can be saved to the PC with DriveWindow, and can easily be downloaded back to the drive whenever needed.

DriveWindow Features

- Easy-to-use tool for commissioning and maintenance
- Several drives connected and monitored at the same time
- Monitor, edit or save signals and parameters, clear graphical presentation
- High-speed communication between PC and drive
- Versatile back-up functions
- View data collected and stored in the drive
- Fault diagnosis; DriveWindow indicates the status of drives, and also reads fault history data from the drive
- Compare function for comparing parameter sets

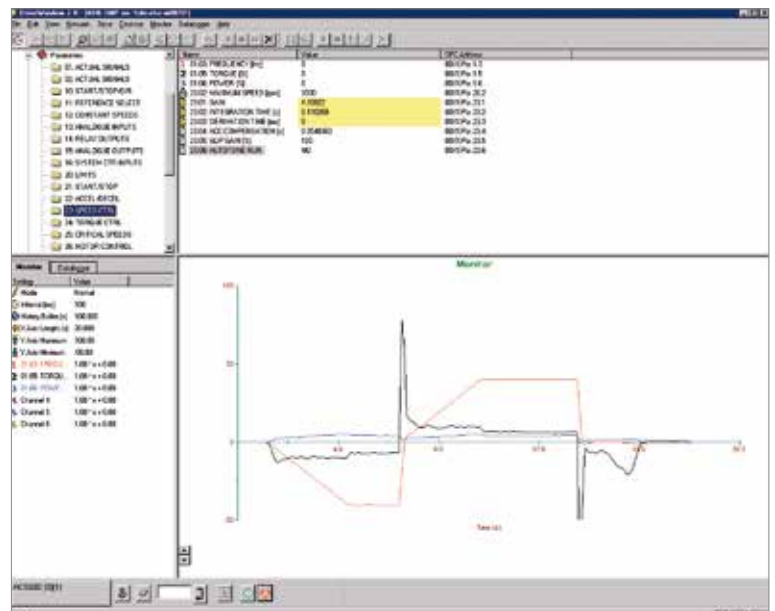

Start-up, maintenance and integration

DriveSize

Quality Dimensioning

DriveSize is a PC program to help the user select the optimal converter and options, especially in those cases where a straightforward selection from a catalog is not possible. Additionally, it can be used to create printed documents about the dimensioning based on actual load.

The default values make DriveSize simple to use, but the user is provided with many options for drive selection. The shortcut keys make drive selection easy while still honoring the relatively complicated rules. A manual selection mode is also supported.

DriveSize is currently used by more than 1000 engineers globally.

DriveSize is for Drive System Components

- Motors
- DCS converter modules
- DCS enclosed converters
- Group drives (line-ups)
- Drive options

DriveSize Features

- Selects the optimal drive unit and motor
- Calculates duty load cycles for converters
- Supplies dimensioning results in graphical and numerical format
- Same tool used for AC and DC
- Excellent tool for supporting small systems
- Prints and saves the results

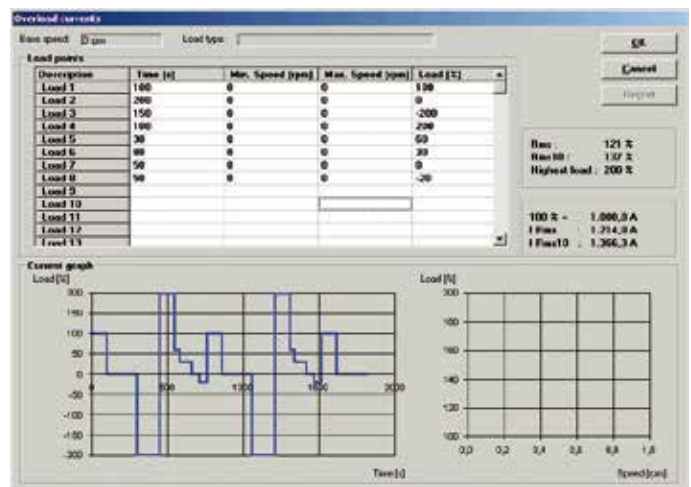
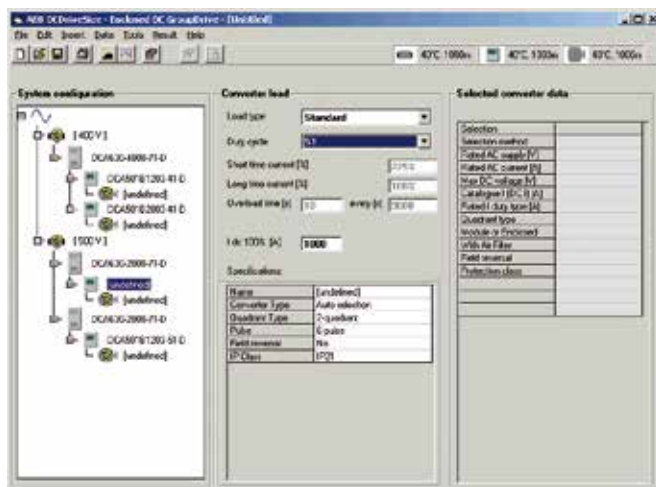
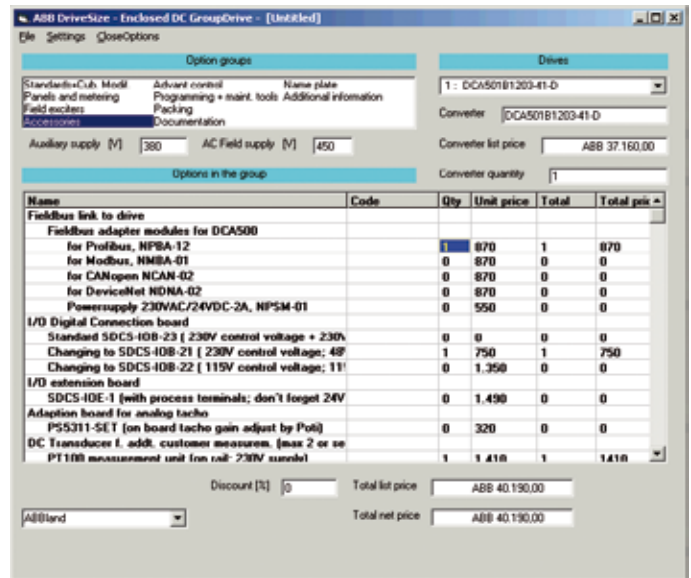

Start-up, maintenance and integration

DriveOPC

Integration Tool

DriveOPC is a software package which allows OLE for Process Control (OPC) communication between Windows applications and DCS800 DC drives. It allows Object Linking and Embedding (OLE) for Process Control (OPC) communication. This OPC server is an ideal tool for integrating DCS800 DC drives with commercial PC software and creating PC-based controlling and monitoring systems.

Remote Monitoring

DriveOPC enables remote connection via LAN (local area networks). The remote PC can be connected by its IP address (e.g. "164.12.43.33") or by the DNS name (e.g. "Gitas213").

OPC Based Software

OPC is an industry standard created in cooperation with Microsoft. It is an open architecture interface design, managed by the international OPC foundation. OPC is meant for different kinds of factory automation.

DriveOPC is based on OPC foundation data access standard 1.0A and Microsoft COM/DCOM technology. DriveOPC has full access to all drives, even when remote connection via LAN is used.

High Speed Communication

DriveOPC uses a high-speed fiber optic cable network with DDCS communication protocol. This makes communication between PC and drives very fast. The fiber optic network is safe and immune to external disturbance. A fiber optic communication card is needed inside the computer.

DriveOPC Features

DriveOPC supports OPC's data access 1.0A.

Read access to:

- Drive status: local, running, direction, fault, warning, reference
- Signals and parameters
- Fault logger contents
- Event logger contents
- General drive information
- Data logger settings, status and contents

Write access to:

- Drive control: local, start, stop, forward, reverse, coast stop, reset fault, home, teach-in, contactor on/off, reference
- Parameters
- Fault logger clear
- Data logger init, start, trig, clear



Remote monitoring tool

Ethernet module

Browser-Based, User-Friendly

The intelligent Ethernet NETA-01 module gives simple access to the drive by means of the Internet communicating via a standard web browser. The user can set up a virtual monitoring room wherever there is a PC with an Internet connection or via a simple dial-up modem connection. This enables remote monitoring, configuration, diagnostics and, when needed, control. The drive can also provide process related information, such as load level, run time, energy consumption and I/O data, the bearing temperature of the driven machine, for instance.

This opens new possibilities for the monitoring and maintenance of unmanned applications across a range of industries, for instance water, wind power, building services and oil & gas, as well as any application where the user needs access to the drives from more than one location. It also provides an opportunity for OEMs and system integrators to support their installed base globally.

No PC Needed at Local End

The intelligent Ethernet module has an embedded server with the necessary software for the user interface, communication and data storage. This gives ease of access, realtime information and the possibility for two-way communication with the drive, enabling immediate response and actions, saving time and money. This is possible without using a PC at the local end, as required by other remote solutions.

Powerful and Versatile

Up to nine drives can be connected to the intelligent Ethernet module via fiber optic links. It is available as an option for new drives, as well as an upgrade for existing systems. Access to the module is secured by user ID and passwords.

The web page of the module is opened like any other web address. The home page shows a general overview of the system with traffic lights and action buttons to guide the user through the different sections.

Features

- Virtual monitoring room for
 - Monitoring
 - Configuration of parameters
 - Diagnostics
 - Control, if needed
- Browser based access via
 - Intra-/extra-/Internet or
 - Email Client
 - Event Notification
 - Drives status update
- No PC needed at the local end
- Can be used as a Modbus/TCP bridge for control purpose

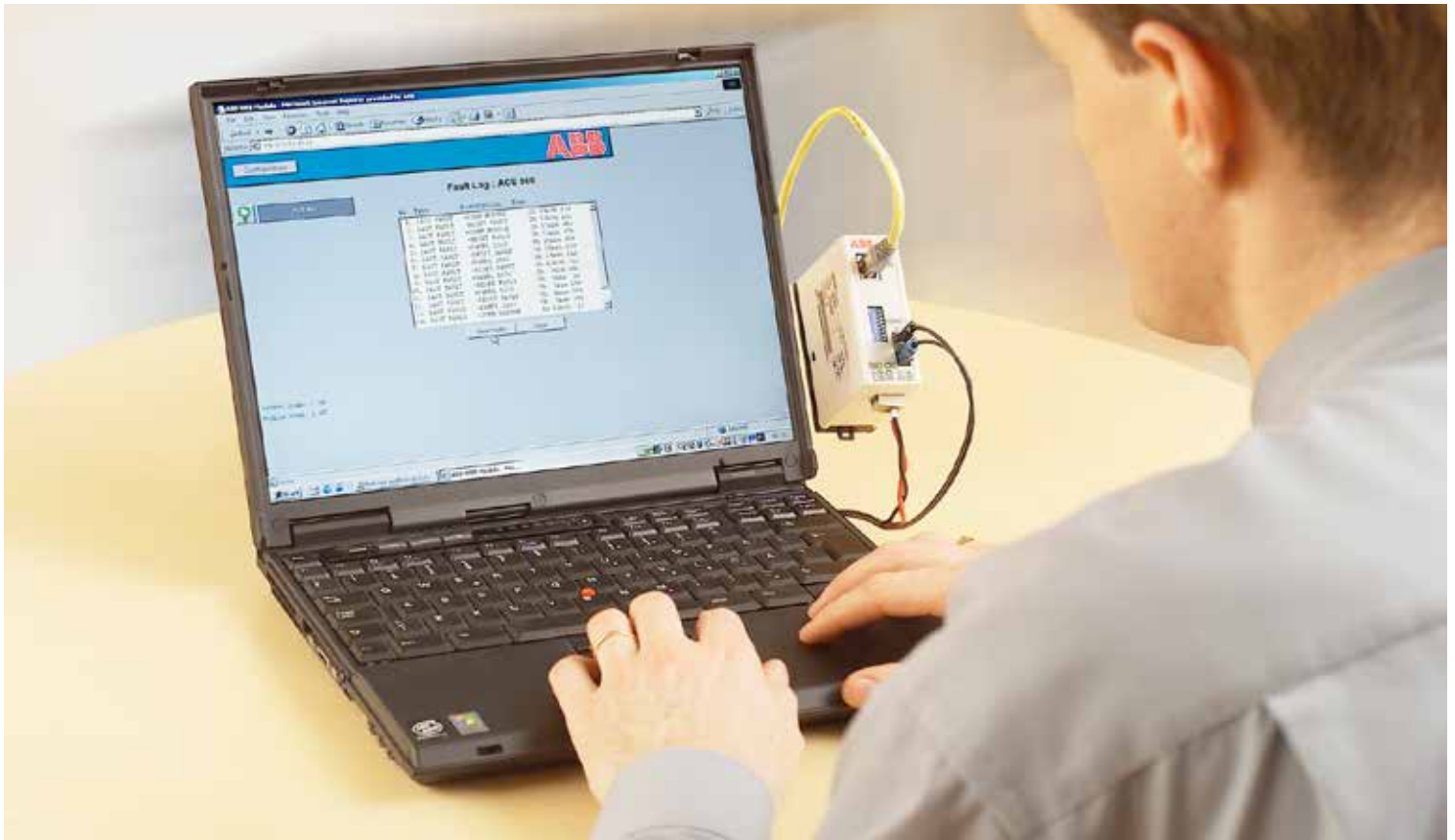

Drawings

DCS800-S01, S02 Power Modules D1-D5 Frames (500 Vdc)

Motor Blower Overload
Size from motor data

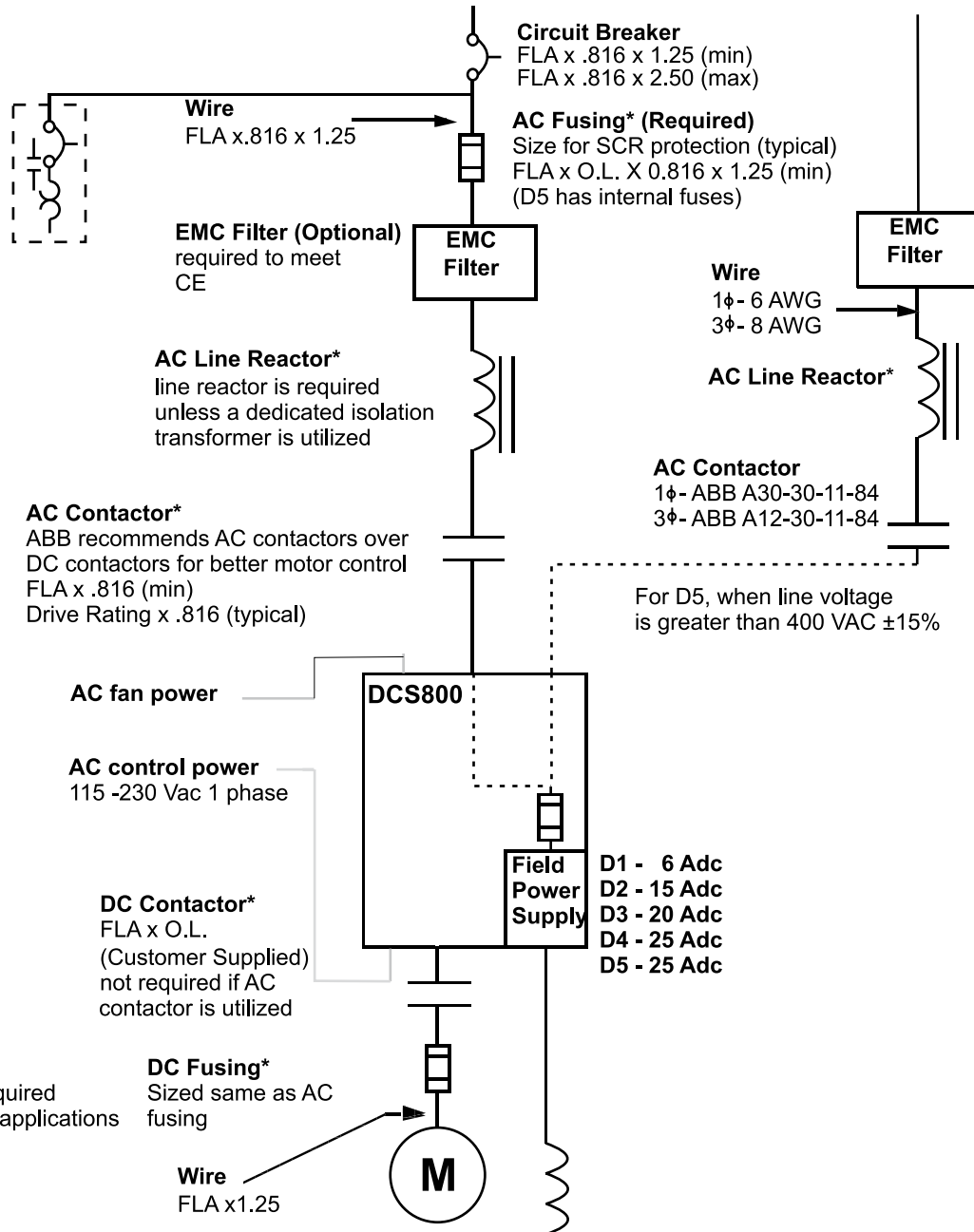

Notes:

* Product recommendations are included in this catalog. See section 3 for details.

Sizing information given on this page are general guidelines. Sizing of system components must comply with local and national electrical codes.

FLA = Nominal DC Motor Current

Motor Data:

HP _____ Model _____ Frame _____

RPM Base/Max _____ / _____

Armature Voltage _____ Amps _____

Field Voltage _____ / Amps _____ / _____ Ohms _____

Overload requirements / Duty cycle _____

Tach: _____ Encoder: _____
Volts/1000RPM _____ PPR _____ Volts _____

Blower:
Voltage _____ Amps _____ Phase _____

Drawings

DCS800-S01, S02 Power Modules D1-D5 Frames (600 Vdc and above) DCS800 D6-D7 Frames (all voltages)

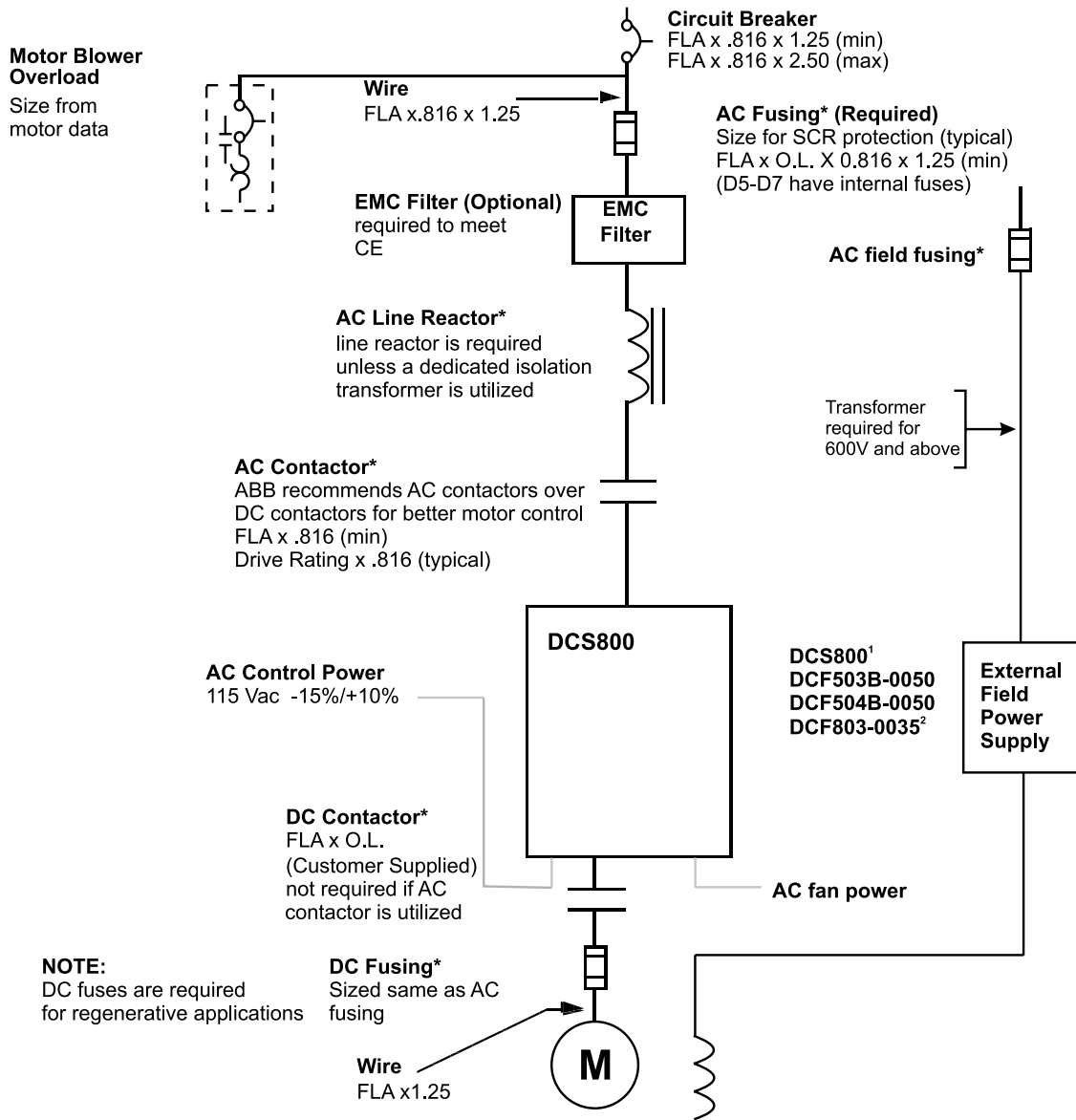

Notes:

¹ Overvoltage protection unit and AC Line reactor required

² Requires AC line reactor. For single phase supply, autotransformer is recommended

* Product recommendations are included in this catalog. See section 3 for details.

Sizing information given on this page are general guidelines. Sizing of system components must comply with local and national electrical codes.

FLA = Nominal DC Motor Current

Motor Data:

HP _____ Model _____ Frame _____

RPM Base/Max _____ / _____

Armature Voltage _____ Amps _____

Field Voltage _____ / Amps _____ / _____ Ohms _____

Overload requirements / Duty cycle _____

Tach: _____ Encoder: _____
Volts/1000RPM _____ PPR _____ Volts _____

Blower:
Voltage _____ Amps _____ Phase _____

Altitude _____ Ambient Temp _____

Spare Parts and Service Products

Spare Part Kits

A stock of spare parts for your DCS800 drive will save you time and minimize expense. Spare parts kits are available to provide ready replacements for the most common parts.

Our standard spare part kits include the following:

- AC input fuses when internally mounted (D5 – D7)
- Field supply fuses when internally mounted (D1 – D5)
- Cooling fan
- Thyristors for one bridge

We also offer optional kits for critical applications which include the following:

- Control board
- Power interface board
- Pulse transformer board
- Power supply board
- Field supply board

Spare parts kits are ordered by drive type code. Not every kit will include all of these parts; it depends on the drive. Spare plug-in options (fieldbus, I/O extensions, etc.) must be ordered separately.

Spare Part Services

ABB offers a fast and effortless information and ordering system to facilitate spare part management. Parts OnLine is at your service 24 hours.

<http://www.abb.com/partsonline>



Service Products

To reduce the total cost of owning ABB drives and to maximize their availability ABB offers the following services:

Training Services

ABB offers dedicated training on ABB drives for your service and operating personnel. Upon successful completion of the training course your personnel will have acquired the skills to use ABB drives correctly and safely, and also to get the best results from their application.

Service product code	Service type	Service type
US190	DCS800 - 3 days	Maintenance & Commissioning
US191	DCS800 - 1 day	Serial Communications

ABB has a service organization that spans the globe. Contact your local ABB sales office for more information about our services.

<http://www.abb.us/drives>

Start-Up Services

Using ABB's start-up services you can trust that your drives are correctly commissioned and well-tuned to their application. ABB employs authorized professionals who have been thoroughly trained for their job.

ABB Maintenance Services

ABB maintenance services ensure optimal operation of your drives and extend their useful life.

Contact us

ABB Inc.

Low Voltage Drives

16250 W. Glendale Drive

New Berlin, WI 53151

Tel: (800) 752-0696

Fax: (262) 785-0397

www.abb.us/drives

DCS800-PHTC01U-EN REVJ Effective 08/25/2012. Subject to change without notice. All rights reserved.